



TOOLS
EQUIPMENT
MACHINES



CATALOGUS

2014 - 2015



INDEX

TOOLS

GEREEDSCHAPSKOFFERS & -WAGENS
P.50-65



GEREEDSCHAPSSETS
P.66-91



GEREEDSCHAP IN TRAYS
P.92-117

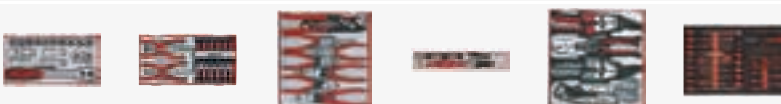

DOPPEN & ACCESSOIRES
P.118-139



DOPPENSETS
P.140-153



SLEUTELS
P.154-173

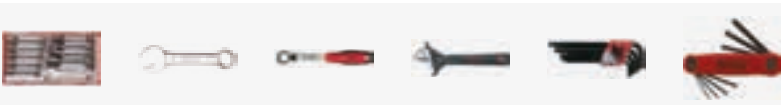

SCHROEVENDRAAIERS & BITSEN
P.174-189

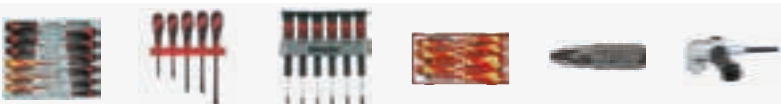

MOMENTSLEUTELS
P.190-197

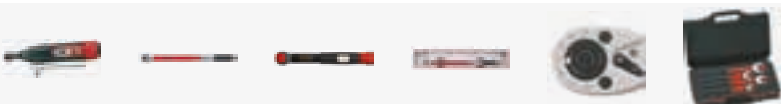

TANGEN
P.198-209

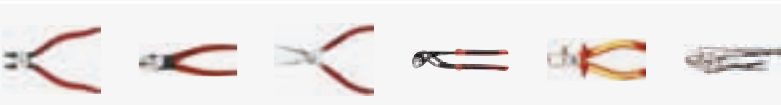

KABELSCHOENTANGEN
P.210-213



RIVETEERTANGEN
P.214-217

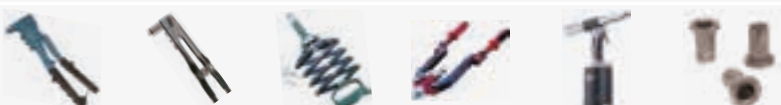

POULIETREKKERS
P.218-221



SLAGGEREEDSCHAP
P.222-229

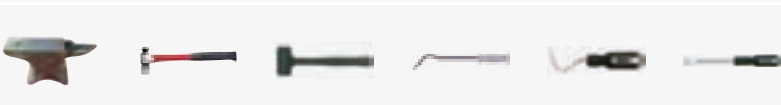

SNIJ -& VIJLGEREEDSCHAP
P.230-239



SMEERGEREEDSCHAP
P.240-243



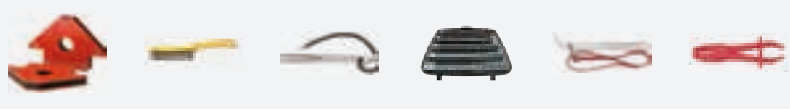

PICKUP -& AUTOTOOLS
P.244-251



MEETGEREEDSCHAP
P.252-299

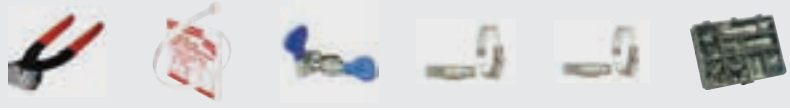

SLANGKLEMMEN
P.300-303

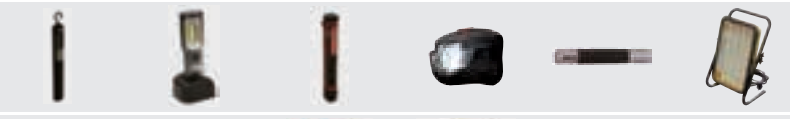

VERLICHTINGSMATERIAAL
P.304-307

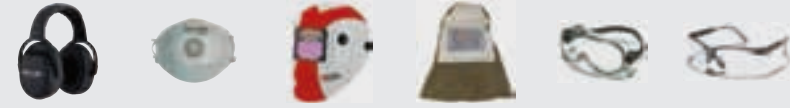

HOOFDBESCHERMING
P.308-323

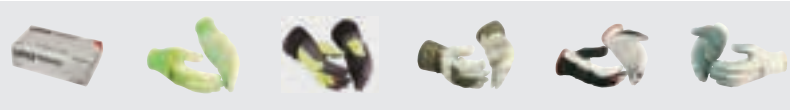

HANDBESCHERMING
P.324-339

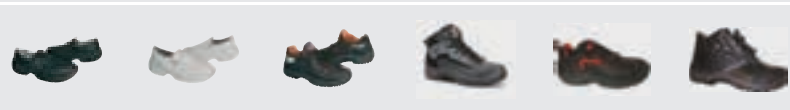

VOETBESCHERMING
P.340-343



WERKKLEDIJ
P.344-363

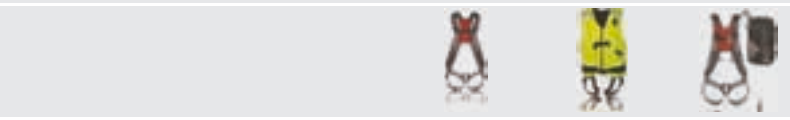

VALBESCHERMING
P.364-365



TRANSPORTMATERIAAL
P.366-371

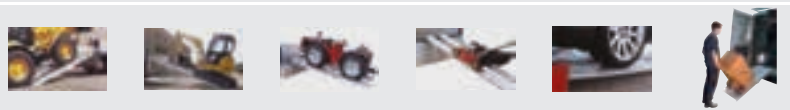

OPRIJPLATEN
P.372-385

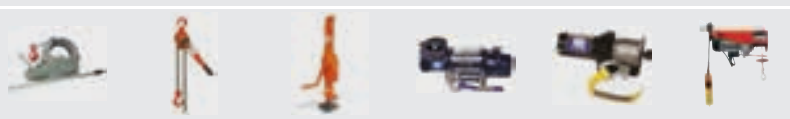

HIJSMATERIAAL
P.386-393

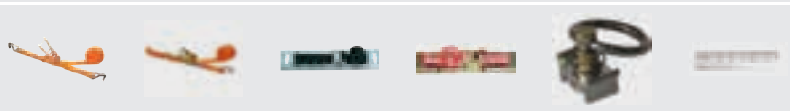

BEVESTIGINGSMATERIAAL
P.394-397



MECHANISCHE WERKPLAATSUITRUSTING
P.398-409



HYDRAULISCHE WERKPLAATSUITRUSTING
P.410-415

INDEX

MACHINES

SIGNALISATIE & VEILIGHEID IN DE WERKPLAATS

P.416-425

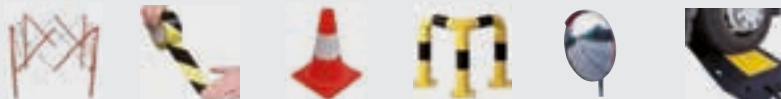

MILIEUVOORZIENINGEN IN DE WERKPLAATS

P.426-431



WERKPLAATSMEUBILAIR

P.432-549

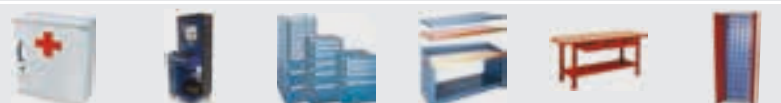

LUCHTDRIJKEREEDSCHAP

P.550-561



COMPRESSOREN

P.562-583



HOUTBEWERKINGSMACHINES

P.584-627



GENERATOREN

P.628-631



BATTERIJLADERS

P.632-647



VERWARMINGSTOESTELLEN

P.648-657



REINIGINGSTOESTELLEN

P.658-659

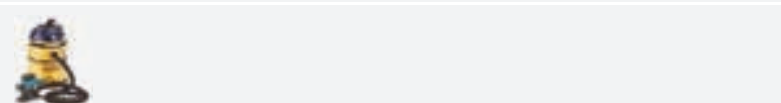

LASTOESTELLEN

P.660-699

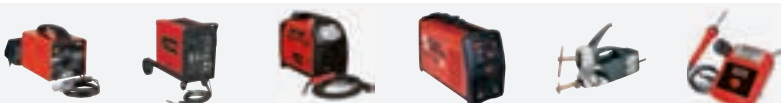

SNIJ -& PLOOIMACHINES

P.700-753



SLIJMACHINES

P.754-775



ZAAGMACHINES

P.776-843



TAFEL -& KOLOMBOORMACHINES

P.844-915





PNEUMATISCHE TAPARMEN
P.916-917



BOOR-FRESMACHINES
P.918-951



DRAAIBANKEN
P.952-999



CNC GESTUURDE MACHINES
P.1000-1011



DIGITAAL METEN OP MACHINES
P.1012-1013

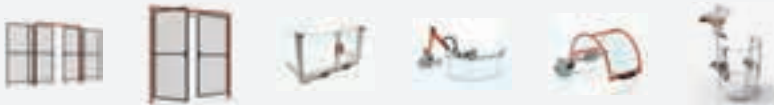

**VEILIGHEIDSAFSCHEMING
OP MACHINES**
P.1014-1025



KLEM -& OPSPANGEREEDSCHAP
P.1026-1051



MACHINEVERLICHTING
P.1052-1053



TAPPEN & KUSSENS
P.1054-1059



FREZEN -& BEITELSETS
P.1060-1073



MACHINEKOELING & OLIËN
P.1074-1077



BOREN
P.1078-1090



KOTTERGEREEDSCHAP
P.1091

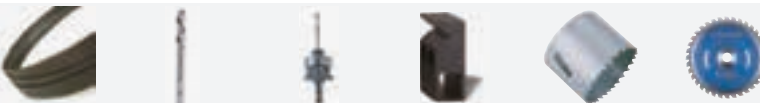

ZAAGBLADEN & KLOKZAGEN
P.1092-1103



SCHUURBANDEN &- SCHIJVEN
P.1104-1108

PRODUCTEN

TOOLS
EQUIPMENT
MACHINES

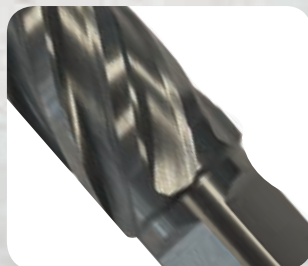

KLANTENDIENST

Onze klantendienst gaat voor u tot het uiterste. We zetten ons iedere dag voor u in en proberen u zo snel mogelijk een antwoord te geven op uw vragen. We staan u bij op technisch en administratief vlak en adviseren u bij de keuze van uw producten, zodat onze samenwerking verder positief kan worden uitgebouwd.

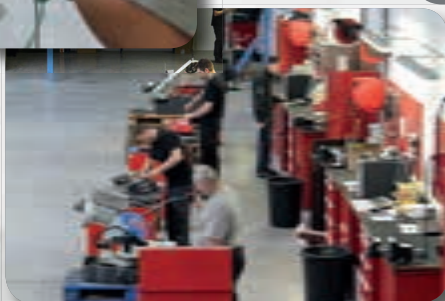

DIENT-NA-VERKOOP

TECHNISCHE ONDERSTEUNING

Onze Profit Centers maken gebruik van een sterke dienst-na-verkoop die alle technische ondersteuning biedt.

Ons atelier werd gevoelig uitgebreid naar meer dan 3000 m². De 9 techniekers genieten een permanente vorming, om u de beste service te kunnen bieden.

HANDLEIDINGEN & WISSELSTUKKEN

Om een handleiding te downloaden, navigeer naar het desbetreffend product in de online catalogus. U vindt de handleiding op diezelfde pagina.

RMA-DOCUMENT

Voor een vlotte en correcte afhandeling van de servicedossiers hebben wij een RMA document ontwikkeld. Wij vragen u dit document goed door te nemen en de voor u nodige stappen te ondernemen.

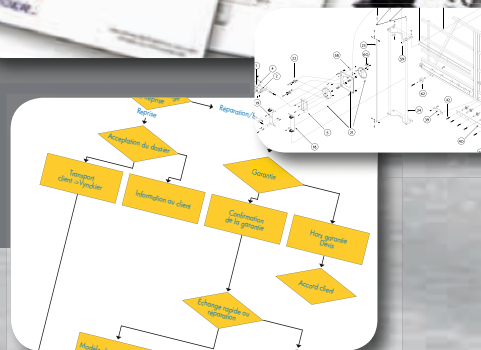

SNELLE LEVERING

Meer dan 120.000 artikels worden gestockeerd, en verdeeld via ons Belux en Europees magazijn naar de Europese markt. Dankzij de distributiepartners, kan VYNCKIER een 24h levertijd garanderen in de Belux markt en een 72h levertijd naar de Europese markt.

Onze producten worden uitsluitend verdeeld via een netwerk van professionele dealers. Deze garanderen een persoonlijk contact en een professionele service in de volledige Belux!

OFFICE THE
NETHERLANDS

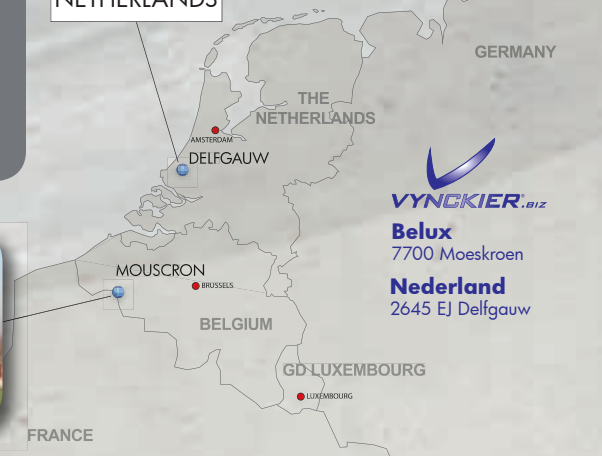

VYNCKIER.biz
Belux
7700 Moeskroen
Nederland
2645 EJ Delfgauw

BENELUX LOGISTIC CENTER

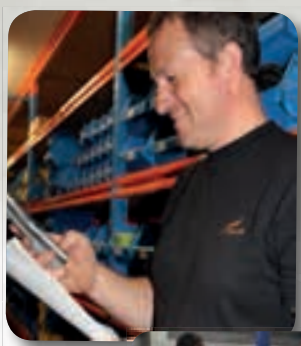
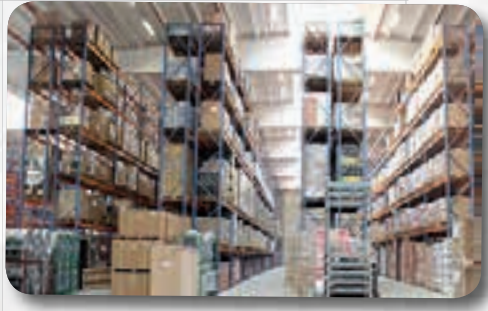

ACADEMY

OPLEIDING OP MAAT

VYNCKIER investeert in opleiding niet enkel voor eigen personeel, maar ook voor zijn verdelers.

Wij zijn ervan overtuigd dat een erkende VYNCKIER verdeler de eindklant op een professionele manier uitleg en technische ondersteuning moet kunnen geven. Daarom heeft VYNCKIER opleidingen ontwikkeld die zowel het accent leggen op een doorgedreven productkennis alsook op de manier waarop een verdeler zijn klanten vakkundig kan bijstaan en voorlichten.



SPONSORING & MARKETING

HUSQVARNA JM RACING TEAM

Het JM Racing Team, onder leiding van Jacky Martens, is de technische partner voor de Europese activiteiten van het Husqvarna motorcross team. Ook zij kozen voor Teng Tools! www.jmracing.mx



TENG TOOLS MASTERS

KIES UW GEREEDSCHAP, EN LAAT 50% SPONSOREN DOOR MR MASTER!

Actief in de autosport, motorsport, motorbootsport,...? Sleutel je vaak aan je wagen, motor, boot, ... om op elke wedstrijd tip-top in orde aan de start te komen? Dan weet je hoe belangrijk goede tools zijn. Dat weet ook Mr. Master. Daarom wil hij jouw team sponsoren. Maak keuze uit een selectie van de Teng Tools sponsor packs, en Mr. Master sponsort 50%. Bovendien rusten we je team gratis uit met T-shirts, petjes, vlaggen, ...
www.tengtoolsmasters.com



TENG TOOLS SPONSORS YOUR TEAM!

Kies uw gereedschap, en laat 50% sponsoren door Mr Master!

Actief in de autosport, motorsport, motorbootsport...? Sleutel je vaak aan je wagen, motor, boot, ... om op elke wedstrijd tip-top in orde aan de start te komen? Dan weet je hoe belangrijk goede tools zijn. Dat weet ook Mr. Master. Daarom wil hij jouw team sponsoren. Maak keuze uit een selectie van de Teng Tools sponsor packs, en Mr. Master sponsort 50%. Bovendien rusten we je team gratis uit met T-shirts, petjes, vlaggen, ...

MARKETING

Onze marketingdienst werkt constant aan de verfijning van de digitale catalogus. Dit garandeert altijd de meest recente productinformatie.

Daarnaast wordt om de 18 maanden een gedrukte versie van de VYNCKIER catalogus verspreid in de Benelux. De oplage van meer dan 40.000 stuks wordt in samenwerking met, en gepersonaliseerd op maat van geselecteerde verdelers ontworpen.



WEBSITE & V-BUSINESS

VYNCKIER.BIZ IN EEN NIEUWE JAS!

Om u nog beter te dienen hebben we vynckier.biz een nieuw gezicht te geven. Hij is hedendaagser en gebruiksvriendelijker.

De nieuwe website toont aan dat er niet stilgezetten wordt bij VYNCKIER. We proberen steeds vooruitkend te zijn en onze klanten zowel online als offline zoveel mogelijk productinformatie aan te bieden.



V-BUSINESS

Ook V-Business kreeg een nieuwe look. Hier hebben VYNCKIER dealers toegang tot business to business informatie, en een reeks handige tools. Zo kan men online bestellingen plaatsen op een snelle en zeer gebruiksvriendelijke manier. Men kan ook alle openstaande orders en lopende herstellingen opvolgen. Het is ook mogelijk om steeds up-to-date stock te raadplegen en handleidingen te downloaden.



NEARLY NEW

Op Vbusiness vindt u ook Nearly New artikelen. Deze bevatten zowel artikelen uit het huidige gamma als ook eindreeksen. Ze worden aangeboden omdat we niet langer over de originele verpakking beschikken, er lichte transportschade is ontstaan, het een demo model betreft of omdat er lichte schade is. Ook tweedehands artikelen kunt u hieronder terugvinden. Deze kleine tekortkomingen worden gecompenseerd onder de vorm van een extra korting. De garantietermijn is dezelfde zoals in de verkoopvoorwaarden van VYNCKIER vermeld, tenzij anders aangegeven.

LEVERINGSVOORWAARDEN

Deze catalogus vervangt alle voorgaande.

Al onze prijzen zijn in euro en exclusief BTW, Bebat, Recupel, Valipac en Verwijderingsbijdrage. Alle leveringen gebeuren uitsluitend volgens onze algemene verkoops-, leverings- en betalingsvoorwaarden welke op simpele aanvraag, aan ons adres, gratis te verkrijgen zijn.

VYNCKIER houdt zich het recht voor om prijzen en/of specificaties van producten aan te passen. De afbeeldingen zijn louter indicatief, de producten kunnen afwijken van de in de catalogus vermelde afbeeldingen.

Garantievoorwaarden en retourprocedure:

De geldende garantievoorwaarden en retourprocedure kan worden geraadpleegd en gedownload via onze website: www.vynckier.biz/nl/service/rma-document.

Alle RMA (Retourneren Met Autorisatie) aanvragen worden doorgestuurd naar emailadres dienstnaverkoop@vynckier.biz of naar faxnummer +32 56 56 14 68. Dit document voor aanvraag is te vinden op www.vynckier.biz/nl/service/rma-document. Daarna ontvangt u van de dienst na verkoop een dossiernummer. Dit dossiernummer dient steeds vergezeld te zijn van de retourgoederen en de verkoopfactuur.

Betaling & eigendomsvoorbehoud:

Al onze facturen zijn contant betaalbaar. De goederen blijven eigendom van VYNCKIER zolang de goederen niet betaald zijn.

Transportkosten:

De goederen reizen op risico van de koper. De berekende vrachtkosten zijn een doorrekening van de geldende transportkosten van GLS, Parts Express, DHL, ... Goederen worden franco ONGELOST geleverd vanaf 400 euro in de Benelux, vanaf 600 euro voor Noord-Frankrijk.

De machineprijzen (> 400 euro) zijn prijzen inclusief transport ONGELOST tot bij de doorverkoper. Anonieme levering van grote machines direct bij de eindklant is mogelijk. Onze prijzen zijn franco levering, ongelost en exclusief installatie. Installatie en inbedrijfstelling gebeuren door de doorverkoper. De installatie en inbedrijfstelling kunnen ook door VYNCKIER uitgevoerd worden op vraag van de doorverkoper en tegen de vooraf afgesproken voorwaarden. Hiervoor dient contact te worden opgenomen met onze commerciële dienst.

Technische specificaties:

Gezien VYNCKIER voortdurend streeft om zijn producten te verbeteren, behoudt VYNCKIER zich het recht om de producten zonder voorafgaande verwittiging te wijzigen. Goederen die uit collectie genomen worden gedurende de looptijd van deze catalogus kunnen geen aanleiding geven tot enige vorm van schadevergoeding of compensatie.

Waarborg:

Op alle VYNCKIER artikelen is 100% garantie op gebrekkelijk materiaal en/of gebrekkige afwerking. Garantie vervalt bij ondeskundig gebruik en/of gebruik van het product voor andere doeleinden of op een andere wijze aan waarvoor zij bestemd zijn.

Leveringstermijnen:

Leveringstermijnen voorzien op de bestelbon of op offertes gelden slechts als aanduiding en verbinden geenszins de verkoper.

De koper kan in geen geval de ontbinding van de overeenkomst, noch schadevergoeding vorderen bij niet-naleving van de leveringstermijn.

Belangrijk!

Tekort of schade bij levering in België/Luxemburg:

Controleer de goederen op transportschade vóór u de vrachtdocumenten ondertekent in het bijzijn van de transporteur. Doe dit ook wanneer de verpakking niet beschadigd is.

1. Bij zichtbare schade vermeldt u de schade onmiddellijk gedetailleerd op de vrachtbrief en laat u deze ondertekenen door de chauffeur. Indien u de vrachtbrief ondertekent zonder opmerkingen kan in geen geval bij de transportverzekering nadien nog een schadeclaim worden ingediend.

Neem vervolgens onmiddellijk contact op met VYNCKIER om de schade te regelen (dienstnaverkoop@vynckier.biz of +32 56 56 14 66).

2. In alle andere gevallen tekent u de vrachtbrief af onder voorbehoud van verder nazicht.

Dit voorbehoud geeft u de mogelijkheid om nadien een schadeclaim in te dienen in geval van onzichtbare schade. Deze claim dient binnen de 5 kalenderdagen schriftelijk te worden gemeld bij VYNCKIER. 5 kalenderdagen na de levering worden geen klachten meer aanvaard.

Dit voorbehoud dient ook te gebeuren in geval van digitale ondertekening van de vrachtbrief.

Tekort of schade bij levering in Nederland:

Controleer de goederen op transportschade vóór u de vrachtdocumenten ondertekent in het bijzijn van de transporteur. Doe dit ook wanneer de verpakking niet beschadigd is.

1. Bij zichtbare schade vermeldt u de schade onmiddellijk gedetailleerd op de vrachtbrief en laat u deze ondertekenen door de chauffeur. Indien u de vrachtbrief ondertekent zonder opmerkingen kan in geen geval bij de transportverzekering nadien nog een schadeclaim worden ingediend. Bij zichtbare schade kan u de zending weigeren.

Neem vervolgens onmiddellijk contact op met VYNCKIER om de schade te regelen (dienstnaverkoop@vynckier.biz of +32 56 56 14 66).

2. In alle andere gevallen dient een klacht binnen de 5 kalenderdagen schriftelijk gemeld te worden aan VYNCKIER met vermelding van de algemene aard van de schade of het verlies. 5 kalenderdagen na de levering worden geen klachten meer aanvaard.

ALFABETISCHE INDEX

A		Analoge meetklok	273, 274, 275
Aambeelden	224	Anti-stick spray	688, 689, 690, 691, 692
Aandrukstuk	586, 587, 589, 592, 593, 595, 597, 598, 599, 601, 607, 612, 616, 619, 621, 626	Armband	350, 351, 352, 353, 354
Aanloopschakelaar	586, 587, 589, 592, 593, 595, 597, 598, 599, 601, 607, 612, 616, 619, 621, 626	Armen met elektrodes	686
Aardingsklem	643, 644, 645, 688, 689, 690, 691, 692	Assteunen	405
Absorptiedoeken	426	Automatische kabelhaspel	307, 406, 407, 408, 409, 550
Absorptiematerialen	426	Autodeuksset	414
Accessoire houtbewerkingsmachine	586, 587, 589, 592, 593, 595, 597, 598, 599, 601, 607, 612, 616, 619, 621, 626	Autogene lasapparaten	666
Accessoires batterijladers	643, 644, 645	Autohefbrug	371
Accessoires gereedschapskoffers en -wagens	52, 59, 60, 61, 62	Autokrik	410, 411, 412, 413
Accessoires houtbewerkingsmachines	602	Autolier	386, 387, 388, 389, 390, 391
Accessoires lastoestellen	666, 673, 674, 675, 683, 688, 689	Automatische voeding	1031
Accessoires mig-mag lasapparaten	673, 674, 675	Automotive gereedschap	107, 108, 110, 138, 244, 245, 246, 247, 251
Accessoires mma lasapparaten	666	B	
Accessoires plasma lasapparaten	688	Bakjeskasten	539, 542
Accessoires plooiomachines	710, 715, 716, 717, 718, 720, 728, 730, 732, 734, 774	Band- en schijfschuurmachines	756, 757, 758, 759, 760, 761, 762
Accessoires poulietrekkers	221	Bandenblazer	550, 552, 553
Accessoires puntlasapparaten	686	Bandendrukmeters	257
Accessoires riveteertangen	217	Bandenprofielmeter	258, 259
Accessoires snelstarters	643, 644, 645	Bandschuurmachine	756, 757, 758, 759, 760, 761, 762
Accessoires snijmachines	710, 715, 716, 717, 718, 720, 728, 730, 732, 734, 774	Bandzaag	780, 781, 787, 788, 789, 790, 791, 792, 794, 795, 796, 798, 800, 802, 804, 806, 808, 810, 812, 814, 816, 818, 820, 822
Accucheck	644	Bankhamer	107, 225, 226
Acculader	636, 637, 638, 639, 640, 641, 642, 643, 646, 647	Bankschroef	258, 539, 1042, 1044, 1045, 1046, 1047, 1048, 1049, 1050, 1051
Accutester	644	Bankvizen	258, 539, 1044, 1045, 1046, 1047, 1048, 1049, 1050, 1051
Adaptier voor kernboren	1026, 1028	Basis gecoate laselektrodes	666, 688, 689
Adaptors	122, 123	Batterijcheck	644
Ademhalingsbescherming	317, 318	Batterijladers	636, 637, 638, 639, 640, 641, 642, 643, 644, 645, 646, 647
Afbakening	416, 417, 418	Batterijladers met transformator	638, 639, 640, 641
Afbreekmes	109, 233, 234	Batterijlader-starter	638, 639, 640, 641
Afkortzaag	785	Batterijtester	644
Afkortzaagmachine	785	Beitelhamers	558, 559
Afscherming	416, 417, 418	Beitels	224, 1060, 1061, 1062, 1063, 1064, 1065, 1066, 1067, 1068, 1069, 1070, 1072
Afscherming T-gleuf	1031	Beitelsset met hm-wisselplaatjes	1062, 1063, 1064, 1065, 1066, 1067, 1069, 1070
Afscherming werkzaamheden	420	Beitelsset met opgelaste hardmetaalplaatjes	1061
Afsluitbareel	416, 417, 418	Bektang	107, 108, 110, 138, 244, 245, 246, 247, 251
Afsluiting	416, 417, 418	Bescherming boormachine	1022, 1023
Afsluiting voor werken	420	Bescherming draaibank	1024, 1025
Afsluitketting	416, 417, 418	Bescherming freesmachine	1023
Afstandhouder	688	Bescherming knie	362
Afstandsmeters	254, 255, 256, 257	Bescherming metaalbewerking	1022, 1023, 1024, 1025
Afstandssensor	254, 255, 256, 257	Bescherming tegen lasspatten	666
Afsteekplaatjes	1062, 1064, 1065, 1066, 1069, 1072	Bescherming T-gleuf	1031
Aftekenaar	267, 268	Beschermingslat voor t-gleuven	1031
Afzetbanden	416, 417, 418	Beschermingsuitrusting	310, 311, 312, 313
Afzellint	416, 417, 418	Beschermerschoenen	340, 341, 342
Afzetpaal	416, 417, 418	Betonijzerschaar	715
Afzetting	416, 417, 418	Betonijzertang	104, 200, 201, 202, 203, 204
Afzuigkit	586, 587, 589, 592, 593, 595, 597, 598, 599, 601, 607, 612, 616, 619, 621, 626	Beugelzaagmachine	780, 781, 787, 788, 789, 790, 791, 792, 794, 795, 796, 798, 800, 802, 804, 806, 808, 810, 812, 814, 816, 818, 820, 822
Aircontrol units	582, 583	Beugelzagen	232
Allensleutels	101, 169, 170, 171	Bevestigingschroef zaagblad	586, 587, 589, 592, 593, 595, 597, 598, 599, 601, 607, 612, 616, 619, 621, 626
Aluminiumafkortzaag	785	Bevestigingsmateriaal	394, 395, 396
Aluminiumzaag	778, 779, 780, 781, 783, 784	Bevestigingsrail	394, 395, 396
Alupull systeem	686		
Ampèremeter	280, 281, 282		

Bewakingsspiegel	425
Bezoekersbril	310, 311, 312, 313
Bi-flex sleutel	100, 165
Bikhamer	688, 689, 690, 691, 692
Bi-metaal zaagbladen	1094, 1095
Binnenmeetasters	257
Binnenmicrometer	276, 277, 278, 279
Binnenzeskantsleutel	101, 169, 170, 171
Bitschroevendraaier	124
Bitsen	102, 120, 184, 185, 186, 187, 188, 189
Bitset	102, 120, 181, 182, 184, 185, 186, 187, 188, 189
Bitshouder	102, 120, 181, 182, 184, 185, 186, 187, 188, 189
Bitsratel	102, 120, 181, 182, 184, 185, 186, 187, 188, 189
Blaaspistolen	550, 551, 552, 553, 554, 561, 583
Blaaspistolenset	550, 551, 553, 561
Bladen voor cirkelzaagmachine	602, 1092
Blikschaar	109, 236, 237
Blindklinkbouten	217
Blindklinknagels	217
Blindklinktang	214, 215, 216
Blok voor aanslag onderpaneel	586, 587, 589, 592, 593, 595, 597, 598, 599, 601, 607, 612, 616, 619, 621, 626
Blokkalibers	258
Blokvijl	110, 239
Blokwinkelhaak	296, 297, 298
Blusdeken	425
Bodywarmers	354, 355
Bolkophamer	107, 225, 226
Bolkraan	551, 552, 554, 583
Boor	1078, 1079, 1080, 1081, 1082, 1083
Boorfreesmachine	918, 920, 922, 924, 926, 928, 930, 931, 932, 933, 934, 936
Boorhouders	849, 1026, 1027, 1028
Boorkalibers	258
Boorklemmen	258, 539, 1043, 1044, 1045, 1046, 1047, 1048, 1049, 1050, 1051
Boorkop	849, 1026
Boormachine	918, 920, 922, 924, 926, 928, 930, 931, 932, 933, 934, 936
Boorslijper	763, 764
Boorslijpmachine	763, 764
Boosters	642, 643, 646, 647
Boren	1078, 1079, 1080, 1081, 1082, 1083
Boren met conische schacht	1084
Borenset	246, 1083, 1084, 1085
Borenslijper	763, 764
Borenslijpmachines	763, 764, 765
Borstels	248
Bougiedoppen	98, 124
Boutenschaar	234
Boutenscharen	234
Bouwlamp	305, 306, 307
Bouwlicht	304
Bovenfreesmachine	938, 940, 942, 944, 946, 948, 950
Brand deken	425
Brandbescherming	363
Branddeken	425
Brandmelder	425
Brandpreventie	425
Brandwerende broek	425
Brandwerende jas	425
Brandwerende kasten	543
Brandwerende overall	425
Brandwerende overall	425
Brandwerende vest	425
Brasseurdraad	688, 689, 690, 691, 692
Breekijzer	108, 227, 228
Breekmessen	109, 233, 234
Bretellenbroek	349
Brillenkoord	310, 311, 312, 313
Brons	234, 235
Buigmachine	718, 724, 725, 727, 728, 729
Buisuitslijpmachine	756, 757, 758, 759, 760, 761, 762
Buitenmicrometer	276, 277, 278, 279
Buizenplooiër	716, 717, 719, 720, 721, 722, 723, 724, 725, 726, 727
Buizensnijders	208, 234, 235
Buizensnijderset	234, 235
Buizen tangen	168
Bureaokabelbrug	420, 421, 422
Bureaokabelkanaal	420, 421, 422
C	
Centerboor	1078, 1079, 1080, 1081, 1082, 1083, 1092, 1093
Centerpunt	224
Centreerpinnen	1087, 1088
Chemisch bestendige handschoen	336, 337, 339
Cijferstempel	290
Circlipstangen	104, 206
Cirkelsnijder voor plasmasnijders	688
Cirkelzaag	778, 779, 780, 781, 783, 784
Cirkelzaagblad voor afkortzaag	602, 1092
Cirkelzaagbladen	1092
Cirkelzaagmachines	778, 779, 780, 781, 782, 783, 784, 785
Cnc freesmachines	1000, 1002, 1004, 1006, 1008
Cnc machines	1000
Coil repair kit	1056
Combinatiefilter	317, 318
Combinatietang	104, 200, 201, 202, 203, 204
Compressoren	564, 565, 566, 567, 570, 571, 574, 576, 577, 579, 582, 583
Conische trapboren	1078, 1079, 1080, 1081, 1082, 1083
Connector	122, 123
Consumables kit	686
Converter	645
Cuttermes	109, 233, 234
D	
Decibelmeter	261
Demagnetiseer	60, 61, 109, 249, 250, 251
Detergent voor vloeren en tapijten	582, 583
Dieptemeters	258, 259
Dieselmodellen	653, 654
Diffusors voor plasmatoorts	688
Digitaal meetgereedschap	257, 263
Digitaal meetsysteem	275, 842
Digitale aanslag	586, 587, 589, 592, 593, 595, 597, 598, 599, 601, 607, 612, 616, 619, 621, 626
Digitale batterijtester	644
Digitale binnenmeetaster	257
Digitale dieptemeter	258, 259
Digitale hoogtemeter	264
Digitale meetklok	273, 274, 275
Digitale multimeter	280, 281, 282, 1012, 1013
Digitale positieaanduiding	1012, 1013
Digitale schuifmaat	285, 286, 287, 288, 289

ALFABETISCHE INDEX

Digitale thermometer	282, 291, 292
Digitale uitlezing	1012, 1013
Digitale waterpas	262, 263, 295
Diktemeters	260, 261
Dinse stekker	688, 689, 690, 691, 692
Direct aangedreven compressoren	564, 565, 566, 567
Directspannende spantang	1029, 1030
Doorduwdoppen	101, 166
Doorslagen	224
Dop	125, 126, 127, 128, 129, 130, 131
Dop- en dopbits schroevendraaiers	124
Dop schroevendraaier	103, 168
Dopbits	124, 125, 126, 127, 128, 129, 130, 131
Dopbitshouder	123
Doppen	97, 98, 101, 105, 106, 107, 120, 121, 122, 123, 124, 125, 126, 127, 128, 129, 130, 131, 132, 134, 135, 136, 137, 138, 139
Doppen 1	131
Doppen 1/2	128, 129, 130, 131
Doppen 1/4	125, 126
Doppen 3/4	131
Doppen 3/8	126, 127, 128
Doppen en accessoires	97, 98, 101, 105, 106, 107, 120, 121, 122, 123, 124, 125, 126, 127, 128, 129, 130, 131, 132, 134, 135, 136, 137, 138, 139
Doppen op rail	151, 152, 153
Doppen op rail 1/2	146, 147, 148, 149
Doppen op rail 1/4	151
Doppen op rail 3/8	151, 152
Doppen op rek	151, 152, 153
Doppen op stag	151, 152, 153
Doppensets	142, 143, 144, 145, 146, 147, 148, 149, 150, 151, 152, 153, 184
Doppensets 1	150
Doppensets 1/2	146, 147, 148, 149
Doppensets 1/4	125, 126, 142, 143
Doppensets 3/4	149
Doppensets 3/8	144, 145, 146
Doppensets rvs	150
Doppensleutelset	101, 120, 121
Dopschroevendraaiers	103, 124, 168
Dopsleutels	101, 120, 121
Draadgeleider voor toorts	673, 674, 675
Draadmicrometer	276, 277, 278, 279
Draadsnijkkussens	1055
Draadsnijmeters	261
Draadsnijwisselplaten	1062, 1064, 1065, 1066, 1069, 1072
Draadvergrendelantag	107, 108, 110, 138, 244, 245, 246, 247, 251
Draagbaar lasapparaat	662, 663, 667, 668, 669, 670, 676, 677, 679, 680, 681, 682
Draagbare inverter	662, 663, 667, 668, 669, 670, 676, 677, 679, 680, 681, 682
Draagbare monofazige inverter	662, 663, 669, 670
Draagbare spotter met koelventilator	684, 685
Draagbare starter	642, 643, 646, 647
Draaibanken	954, 956, 957, 958, 960, 962, 964, 968, 970, 972, 974, 976, 978, 980, 982, 984, 986, 988, 990, 992, 994, 996, 998
Draaibeitelset	586, 587, 589, 592, 593, 595, 597, 598, 599, 601, 607, 612, 616, 619, 621, 626
Draaidsnijwisselplaten	1062, 1064, 1065, 1066, 1069, 1072
Draaimomentsleutel	105, 192, 194, 195, 196, 197
Draaisnijplaatje	1062, 1064, 1065, 1066, 1069, 1072

Drempel	422, 423, 424
Driehoekige vijl	110, 239
Drieklauw	1037, 1038, 1039, 1040
Droog vacuüm	658
Drukschakelaar	551, 552, 554, 583
Druppellader	636, 637, 638, 639, 640, 641
Dubbele ringsleutel	100, 160, 161, 162, 163
Duimband	362
Duimstok	254, 269, 270, 271
Duwbotsen	710, 715, 716, 717, 718, 720, 728, 730, 732, 734, 774
Duwmatrijzen	710, 715, 716, 717, 718, 720, 728, 730, 732, 734, 774

E

Eindstuk voor verkeersdrempel	422, 423, 424
Elektrische lier	386, 387, 388, 389, 390, 391
Elektrische modellen	650, 651, 652
Elektrische takels	386, 387, 388, 389, 390, 391
Elektrische ventilator	656, 657
Elektrische verwarming	650, 651, 652
Elektrische warmtestraling	650, 651, 652
Elektrode inverter	664, 665
Elektrode lastoestel	664, 665
Elektrodelasapparaat	664, 665
Elektroden voor plasmatoorts	688
Elektronische schuifmaat	285, 286, 287, 288, 289
Els	107, 228, 229
Engelse sleutel	168

F

Fijndraaibank	957, 968, 972, 974, 978, 982, 986, 990, 992
Fijnstofmasker	317, 318
Filterdrukregelaar	582, 583
Filterpatronen	586, 587, 589, 592, 593, 595, 597, 598, 599, 601, 607, 612, 616, 619, 621, 626
Filtersleutel	107, 108, 110, 138, 244, 245, 246, 247, 251
Fleeces	354, 355
Flensen	1037, 1039
Flenshoekhaken	261
Fleskriks	410, 414, 415
Flexhendels	97, 122
Flexibele leiding	551, 552, 554, 583
Flexringsleutels	100, 165
Fluo hesjes	350, 351, 352, 353, 354
Fluo vest	350, 351, 352, 353, 354
Flux lasdraad	688, 689, 690, 691, 692
Flux-mig lastoestellen	676, 677
Frees met CNC besturing	1002, 1008
Freesbank	938, 940, 942, 944, 946, 948, 950, 957, 968, 972, 974, 978, 982, 986, 990, 992, 1002, 1008
Freeshouders	1028, 1029, 1030
Freesklemmen hydraulisch	258, 1043, 1044, 1045, 1046, 1047, 1048, 1049, 1050, 1051
Freesmachines	880, 882, 884, 892, 894, 896, 898, 900, 902, 904, 906, 908, 910, 918, 920, 922, 924, 926, 928, 930, 931, 932, 933, 934, 936, 938, 940, 942, 944, 946, 948, 950, 1002, 1008
Frequentie omvormer	710, 715, 716, 717, 718, 720, 728, 730, 732, 734, 774
Frequentiemeter	280, 281, 282
Frezensets	1060
Garagekraan	410, 411, 412, 413, 414, 415

Garagekrik	410, 411, 412, 413
Garageligbed	405
Garagerolbed	405
Garagestands	405
Garagestoel	405
Gasdiffusor voor toortsen	673, 674, 675
Gasfilter	317, 318
Gaslesadaptor	673, 674, 675
Gasmodellen	655
Gasregelaar	673, 674, 675
Gasregelaar met manometer	673, 674, 675
Gatzagen	1092, 1093
Gecombineerde lasbranden en snijtoestel	666
Geconcentreerde snijolie	1075, 1076
Geharde rollen	710, 715, 716, 717, 718, 720, 728, 730, 732, 734, 774
Gehoorscherming	318, 319, 320
Geijkte bandenblazer	551, 552, 554, 583
Geïsoleerde schroevendraaiers	103, 183, 184
Geïsoleerde tang	104, 204, 205
Gekoelde draagbare lasinverter	667, 668
Geleidingsolie	1074
Geluidniveauometer	261
Geluidsdrukmeter	261
Geluidsmeters	261
Generatoren	629, 630, 631
Gepoederde transparante vinyl handschoenen	339
Gereedschap in eva foam	111, 112, 113, 114, 115, 116
Gereedschap in muurrekken	117
Gereedschap in ps trays	53, 94, 95, 96, 97, 98, 99, 100, 101, 102, 103, 104, 105, 106, 107, 108, 109, 110, 181
Gereedschap in trays	53, 94, 95, 96, 97, 98, 99, 100, 101, 102, 103, 104, 105, 106, 107, 108, 109, 110, 111, 112, 113, 114, 115, 116, 117, 181
Gereedschapshouder	117
Gereedschapskast	64, 65, 434, 435, 436, 437, 438, 440, 441, 442, 444, 446, 447, 448, 449, 450, 451, 452, 456, 484, 486, 487, 488, 489, 490, 491, 492, 493, 494, 495, 516, 518, 519, 520, 522, 524, 525, 526, 527, 528, 529, 530, 531
Gereedschapskist	77, 79, 85
Gereedschapskoffer	52, 53, 54, 55, 56, 57, 58, 59, 63, 64, 77, 79, 85
Gereedschapsladen	53, 94, 95, 96, 97, 98, 99, 100, 101, 102, 103, 104, 105, 106, 107, 108, 109, 110, 181
Gereedschapset	77, 79, 85, 153
Gereedschapstafel	496, 497, 498, 499, 500, 502, 504, 505, 506, 510, 511, 512, 513, 514, 515, 517
Gereedschapstas	52, 53, 54, 55, 56, 57, 58, 59, 63, 64
Gereedschapstrolley	77, 79, 85
Gereedschapswagens	52, 53, 54, 55, 56, 57, 58, 59, 63, 64, 65
Gereflecteerde broek	350, 351, 352, 353, 354
Gereflecteerde jas	350, 351, 352, 353, 354
Gereflecteerde t-shirt	350, 351, 352, 353, 354
Geslepen boren	246, 1083, 1084, 1085
Geslepen metaalboor	1078, 1079, 1080, 1081, 1082, 1083
Getande v-riem	551, 552, 554, 583
Gevulde lasdraad	688, 689, 690, 691, 692
Gewalste boren	246, 1083, 1084, 1085
Gezichtafscherming	313
Gezichtbescherming lassen	314, 316
Gezichtsscherm	313
Gietstaal	224
Gradenbogen	262, 263
Grafietbanden	248, 587, 764, 773, 1104, 1105, 1106, 1107, 1108
Graveerapparaat	263
Griptangen	105, 206, 207, 208
Groeven voor rolmachines	710, 715, 716, 717, 718, 720, 728, 730, 732, 734, 774
H	
Haakpinsleutels	100, 167
Haakse bitshouder	102, 120, 181, 182, 184, 185, 186, 187, 188, 189
Haakse sleutels	1030
Halfgelaatsmasker	317, 318
Halfronde vijl	110, 239
Halogeen werklamp	1052, 1053
Halogeenlampprojector	304
Hamerlasbouten	693
Hammers	107, 225, 226
Handbescherming	330, 331, 332, 333, 334, 335, 336, 337, 338, 339
Handboormachine	553
Handborstel	248
Handgereedschap	77, 79, 85
Handkar	366, 367, 370
Handlampen	305, 306, 307
Handmultimeter	280, 281, 282
Handschoen	330, 331, 332, 333, 334, 335, 336
Handschoen in keperdoek	337, 338
Handschoen tegen chemische producten	336, 337, 339
Handschoenen voor assemblage	331, 332
Handschoenen voor chemische bescherming	336, 337
Handschoenen voor licht werk	331, 332
Handschoenen voor precisiewerk	330
Handschoenen voor ruw werk	333, 334
Handschoenen voor snijbescherming	336
Handschoenen voor wintertemperatuur	335
Handschoenen voor zwaarder werk	333, 334
Handstapelaars	371
Handtaket	392, 393
Handtappen	1054, 1055
Handtranspallet	368, 369
Handvijl	110, 239
Handzaag	232
Hanglamp	305, 306, 307
Hardheidsmeters	263
Hartzoeker	296, 297, 298
Hefbrug	371
Hefmagneet	393
Heftafels	371
Hemden	358
Herriemeter	261
Hex bits	102, 120, 181, 182, 184, 185, 186, 187, 188, 189
High visibility	350, 351, 352, 353, 354
Hijsmateriaal	386, 387, 388, 389, 390, 391, 392, 393
Hijsstoestel	386, 387, 388, 389, 390, 391, 392, 393
Hittebestendige dekens	666
Hobbymes	109, 233, 234

ALFABETISCHE INDEX

Hoeksleutel	107, 108, 110, 138, 244, 245, 246, 247, 251	Kegeldoorns	1027, 1028
Hoekuitkapmachine	738	Kernboor	1087, 1088
Holpijpen	227	Kernboormachine	844, 845, 846, 847, 848, 849
Hoofdbescherming	310, 311, 312, 313, 314, 315, 316, 317, 318, 319, 320	Kernboren	1087, 1088
Hoofddeksel	317	Kettingtakels	392, 393
Hoofdlamp	305, 306, 307	Klapstoel	405
Hoogtemaat	264	Klassieke verwarming	653, 654
Hoogte-meetapparaat	275, 842	Klauwhamer	107, 225, 226
Hoogtemeter	264, 275, 842	Klauwplaat	1033, 1037, 1038, 1039, 1040
Houtbewerking	248, 587, 658, 756, 757, 758, 759, 760, 761, 762, 764, 773, 1104, 1105, 1106, 1107, 1108	Klauwplaat voor houtdraaibanen	586, 587, 589, 592, 593, 595, 597, 598, 599, 601, 607, 612, 616, 619, 621, 626
Houtbewerkingsmachines	658	Klauwplaten en flensen	1037, 1038, 1039, 1040
Houtboren	246, 1083, 1084, 1085	Kleerkasten	543
Houtsplitters	612	Klemmen	586, 587, 589, 592, 593, 595, 597, 598, 599, 601, 607, 612, 616, 619, 621, 626
Houtzaag	232	Klemmense	258, 586, 587, 589, 592, 593, 595, 597, 598, 599, 601, 607, 612, 616, 619, 621, 626, 1044, 1045, 1046, 1047, 1048, 1049, 1050, 1051
Huishoudhandschoen	336, 337, 339	Klemtangen	107, 108, 110, 138, 244, 245, 246, 247, 251
Hydraulische atelierpers	700, 701, 702, 703, 704, 705, 706, 707, 708, 709	Klokzagen	1092, 1093
Hydraulische fleskrik	410	Knabbelscharen	554
Hydraulische hefbrug	371	Kniebescherming	362
Hydraulische hoekuitkapmachine	738	Knielappen	362
Hydraulische persen	700, 701, 702, 703, 704, 705, 706, 707, 708, 709	Kniptang	104, 200, 201, 202, 203, 204
Hydraulische rolkrik	410, 411, 412, 413	Knipscharen	711, 712, 713
Hydraulische uitdeukset	414	Kniptang	104, 200, 201, 202, 203, 204
Hydrolische olie	1074	Koel- en snijolie	1075, 1076
Hydropneumatische rolkrik	410, 411, 412, 413	Koelinrichting	1077
Hygiëne kit	318, 319, 320	Koelinstallatie	1077
Hygiënemasker	317, 318	Koelpomp	1077
I		Koevoet	108, 227, 228
Imbussleutel	101, 169, 170, 171, 173	Kogelklep	551, 552, 554, 583
Inbussleutel	101, 169, 170, 171, 173	Kogelkraan	551, 552, 554, 583
Indeling kast	547	Kolomboormachine	850, 851, 852, 853, 854, 855, 856, 858, 860, 862, 864, 866, 868, 870, 872, 874, 876, 878, 880, 882, 884, 892, 894, 896, 898, 900, 902, 904, 906, 908, 910
Infrarood heaters	650, 651, 652	Kolomvijzels	413
Infrarood verwarming	650, 651, 652	Koolborstels	586, 587, 589, 592, 593, 595, 597, 598, 599, 601, 607, 612, 616, 619, 621, 626
Inline drukregelaar	582, 583	Koper	234, 235
Inox lasdraad	688, 689, 690, 691, 692	Koper lasdraad	688, 689, 690, 691, 692
Inslagletters	290	Kopiëerinrichting voor houtdraaibanen	586, 587, 589, 592, 593, 595, 597, 598, 599, 601, 607, 612, 616, 619, 621, 626
Inspectie camera	250, 251, 264, 265, 266, 267	Kopkniptang	104, 200, 201, 202, 203, 204
Inspectieapparatuur	250, 251, 264, 265, 266, 267	Koppeling orion	551, 552, 554, 583
Inspectiespiegel	250, 251, 264, 265, 266, 267	Koppelvermeerderaars	105, 124
Intelligente laders en starters	636, 637	Koptelefoon	318, 319, 320
Interventiekits	426	Korte beitelhamer	558, 559
Inverter	629, 630, 631, 667, 668, 676, 677, 679, 680, 681, 682	Korte broek	346, 347, 348
J		Kotterkop voor boormachines	1026
Jacket	354, 355	Kotterkoppen	1091
Jas	354, 355	Krachtvermeerderaar	105, 124
Jerrycans	398	Krasblokken	267
K		Kraspenen	267, 268
Kabel knipper	202, 236	Krimpsysteemtang	214, 215, 216
Kabelbescherming	420, 421, 422	Krimptang	107, 210, 211, 212, 213
Kabelbeveiliging	420, 421, 422	Krompasser	283, 284
Kabelbruggen	420, 421, 422	Kruiskopschroeverdraaier	102, 103, 116, 153, 176, 177, 178, 179, 180, 181, 182
Kabelhaspel	307, 406, 407, 408, 409, 550	Kruistafel	258, 539, 1042, 1044, 1045, 1046, 1047, 1048, 1049, 1050, 1051
Kabelkanaal	420, 421, 422	Kussen- en tappendoos	108, 1057, 1058, 1059
Kabelkrimptang	107, 210, 211, 212, 213		
Kabellier	386, 387, 388, 389, 390, 391		
Kabelscharen	202, 236		
Kabelschoentangen	107, 210, 211, 212, 213		
Kabeltakel	386, 392, 393		
Kaliber voor boren	258		
Kaliber voor lassen	268		

Kussen- en tappenhouders	1055, 1056	Looplamp	305, 306, 307
Kussenhouder	1055, 1056	Losse spantangen	1029, 1030
L		Luchtcompressor	579
Laadvlak	366	Luchtdruk beitelhamer	558, 559
Laboratoriumbril	310, 311, 312, 313	Luchtdruk blaaspistool	550, 551, 553, 561
Ladekast	434, 435, 436, 437, 438, 440, 441, 442, 444, 446, 447, 448, 449, 450, 451, 452, 456, 484, 486, 487, 488, 489, 490, 491, 492, 493, 494, 495, 526	Luchtdruk boormachine	553
Laden	53, 94, 95, 96, 97, 98, 99, 100, 101, 102, 103, 104, 105, 106, 107, 108, 109, 110, 181	Luchtdruk cartouchepistool	551, 552, 554, 583
Ladenkasten	484, 486, 487, 488, 489, 490, 491, 492, 493, 494, 495, 540, 541	Luchtdruk gereedschap	551, 552, 554, 583
Ladenverdeling	53, 94, 95, 96, 97, 98, 99, 100, 101, 102, 103, 104, 105, 106, 107, 108, 109, 110, 181	Luchtdruk gereedschapsaantrekker	1032
Lagersolie	1074	Luchtdruk knabbelshaar	554
Lampjesters	268	Luchtdruk olie	1074
Lange bits	102, 120, 181, 182, 184, 185, 186, 187, 188, 189	Luchtdruk taparm	916
Lange broek	346, 347, 348	Luchtdruk verfpistool	559, 560, 561
Lasafscherming	666	Luchtdruk gereedschap	107, 550, 551, 552, 553, 554, 555, 556, 557, 558, 559, 560, 561
Lasapparaat	662, 663, 669, 670, 676, 677, 679, 680, 681, 682	Luchtgereedschap	107, 555, 556, 557, 558
Lasbekken	673, 674, 675	M	
Lasbescherming	666	Maatlat	254, 268, 269, 270, 271
Lasbout	693	Machineklem	1044, 1045
Lasbrander	666	Machinelamp	1052, 1053
Laser afstandmeter	254, 255, 256, 257	Machinelicht	1052, 1053
Laser geleiding	586, 587, 589, 592, 593, 595, 597, 598, 599, 601, 607, 612, 616, 619, 621, 626	Machinetap	1054, 1055
Lashandschoenen	337	Machinetap	1041
Lashelmen	314, 315, 316	Machineuitrusting	1031, 1032
Lasinverter	662, 663, 667, 668, 669, 670	Machineverlichting	1052, 1053
Laskabelset	666, 688, 689	Machinevoet	586, 587, 589, 592, 593, 595, 597, 598, 599, 601, 607, 612, 616, 619, 621, 626
Laskalibers	268	Magazijnbakjes	547, 548
Laskap	314, 316	Magazijnwagen	366
Lasmagneten	60, 61, 109, 249, 250, 251	Magneet	60, 61, 109, 249, 250, 251
Lasmuts	317	Magneet meetstandaard	272, 273
Las pistool	693	Magneet rek	60, 61, 109, 249, 250, 251
Lasrivetten voor spotters	686	Magneetbar	60, 61, 109, 249, 250, 251
Las scherm	666	Magneetboormachines	844, 845, 846, 847, 848, 849
Las schort	666	Magneet meetstandaard	272, 273
Lasset	683	Magnesium legering aluminium elektrode	688, 689, 690, 691, 692
Lasset aluminium	673, 674, 675	Magneten	60, 61, 109, 249, 250, 251
Lastang voor elektroden	688, 689, 690, 691, 692	Magnetische bitshouder	102, 120, 181, 182, 184, 185, 186, 187, 188, 189
Lastips	673, 674, 675	Magnetische opspanplaten	258, 1044, 1045, 1046, 1047, 1048, 1049, 1050, 1051
Lastoestellen	662, 663, 664, 665, 666, 667, 668, 669, 670, 671, 672, 673, 674, 675, 676, 677, 679, 680, 681, 682, 683, 684, 685, 686, 687, 688, 689, 690, 691, 692, 693	Magnetische rail	60, 61, 109, 249, 250, 251
Lasvet	693	Mallen	271
Lasvloeistof	693	Manometer	551, 552, 554, 583
Latex handschoenen	336, 337, 339	Manuele aanvoerhulp	627, 839, 841, 842
Led lamp	305, 306, 307	Manuele persen	714
Lekbakken	403, 404, 426, 427, 428, 429, 430, 431	Manuele tafelspers	700, 701, 702, 703, 704, 705, 706, 707, 708, 709
Lendenband	362	Markeerkrijt	272
Lier	386, 392, 393	Markeerstiften	272
Ligbed	405	Materiaalreiniger	313, 402, 403
Lijmklem	209	Materiaalschraag	626, 627, 838
Lijmtang	209	Materiaalstand	626, 627, 838
Lintzaagbladen	1094, 1095	Materiaalsteunen	626, 627, 838
Lintzaagmachines	787, 788, 789, 790, 791, 792, 794, 795, 796, 798, 800, 802, 804, 806, 808, 810, 812, 814, 816, 818, 820, 822, 824, 826, 828, 830, 832, 834, 836	Mechanische freesklemmen	258, 1044, 1045, 1046, 1047, 1048, 1049, 1050, 1051
		Mechanische takels	392, 393
		Meecutwax	1075, 1076
		Meedraaiende centerpunten	1034
		Meelopende bril	1033
		Meetapparaat	257, 263, 280, 281, 282, 289, 291, 292
		Meetapparaat voor toerental	290, 291
		Meetgereedschap	254, 269, 270, 271

ALFABETISCHE INDEX

Meetinstrument	263, 282, 283, 284, 291, 292	Motorische pers	700, 701, 702, 703, 704, 705, 706, 707, 708, 709
Meeteklokken	273, 274, 275	Motorstands	405
Meetlat voor lengteaanslag	586, 587, 589, 592, 593, 595, 597, 598, 599, 601, 607, 612, 616, 619, 621, 626	Motorsteun	405
Meetlint	254, 269, 270, 271	Motorlaketel	392, 393
Meetsets	110	Mouwteleshemd	359
Meetstandaards	272, 273	Multimeters	280, 281, 282
Meetsokken	276	Multistand	626, 627, 838
Meetwiel	254, 269, 270, 271	Musketon	394, 395, 396
Metaal zaag	232	Mutsen	317
Metaalafkortzaag	785	Muurkasten	64, 65, 516, 518, 519, 520, 522, 524, 525, 526, 527, 528, 529, 530, 531
Metaalbandschuurmachine	756, 757, 758, 759, 760, 761, 762	Muurvlag	229
Metaalbeitel	224	N	
Metaalboor	246, 850, 851, 852, 853, 854, 855, 856, 858, 860, 862, 864, 866, 868, 870, 872, 874, 876, 878, 880, 882, 884, 892, 894, 896, 898, 900, 902, 904, 906, 908, 910, 918, 920, 922, 924, 926, 928, 930, 931, 932, 933, 934, 936, 1078, 1079, 1080, 1081, 1082, 1083, 1084, 1085	Naalvijl	110, 239
Metaalboormachine	844, 845, 846, 847, 848, 849	Nagellang	104, 200, 201, 202, 203, 204
Metaalborenset	246, 1083, 1084, 1085	Nat vacuum	658
Metaaldraaibank	957, 968, 972, 974, 978, 982, 986, 990, 992	Neon werkklamp	1052, 1053
Metaalfrees	918, 920, 922, 924, 926, 928, 930, 931, 932, 933, 934, 936, 938, 940, 942, 944, 946, 948, 950, 1002, 1008	Nijplang	104, 200, 201, 202, 203, 204
Metaalfreesbank	938, 940, 942, 944, 946, 948, 950, 1002, 1008	Niveaumeetapparaat	261
Metaalfreesmachine	938, 940, 942, 944, 946, 948, 950, 1002, 1008	Niveaumeter	261
Metaallinzzaagmachine	780, 781, 787, 788, 789, 790, 791, 792, 794, 795, 796, 798, 800, 802, 804, 806, 808, 810, 812, 814, 816, 818, 820, 822	O	
Metaalschaar	109, 236, 237, 711, 712, 713, 715, 716, 738	Olie	403, 404, 426, 427, 428, 429, 430, 431, 1074
Metaalzaag	602, 778, 779, 780, 781, 783, 784, 785, 787, 788, 789, 790, 791, 792, 794, 795, 796, 798, 800, 802, 804, 806, 808, 810, 812, 814, 816, 818, 820, 822, 1092, 1094, 1095	Olieopvang	403, 404
Metalboorkop	849, 1026	Olievernevelaar	582, 583
Metalen koffer	544, 545, 546, 547	Ombouwset	710, 715, 716, 717, 718, 720, 728, 730, 732, 734, 774
Micrometers	276, 277, 278, 279	Omgevingsspiegels	425
Mig-mag lasapparaten	667, 668, 669, 670, 671, 672	Omhoogklapbare beschermbril	314, 316
Migtoortsen	673, 674, 675	Onderdelenreinigers	400, 401
Milieukasten	543	Onderstel	710, 715, 716, 717, 718, 720, 728, 730, 732, 734, 774
Millivoltmeter	280, 281, 282	Ondersteuningsbok	626, 627, 838
Minerale compressor olie	1074	Ontbraamborstel	248, 587, 764, 773, 1104, 1105, 1106, 1107, 1108
Minerale transmissie olie	1074	Ontvetter	400, 401
Mma lasapparaten	696, 697	Oogbescherming	310, 311, 312, 313
Mobiele gereedschapswagen	52, 53, 54, 55, 56, 57, 58, 59, 63, 64	Oogveiligheid	310, 311, 312, 313
Mobiele ventilator	656, 657	Oorbescherming	318, 319, 320
Moeniertang	104, 200, 201, 202, 203, 204	Oordopjes	320
Moersleutel	101, 167, 168	Oorkap	318, 319, 320
Momentsleutels	105, 192, 194, 195, 196, 197	Oorpropjes	320
Monoblok vlakfrees	1061	Opbergbak	547
Montage ratel-pin sleutel	166	Opbergkasten	434, 435, 436, 437, 438, 440, 441, 442, 444, 446, 447, 448, 449, 450, 451, 452, 456, 526
Montage ringsleutel	166	Opbergkoffer	77, 79, 85, 544, 545, 546, 547, 548
Montagesleutels	166	Opbergsysteem	117
Montagestoelen	405	Opberggas	310, 311, 312, 313
Morse konus borensets	1084	Openingsmal	271
Motolift	371	Opgebraseerde beitels	1061
Motorbeveiliging	551, 552, 554, 583	Opnameflensen	1037, 1039
Motorhanger	410, 414, 415	Opraper van spanen	1032
		Oprijdrempel	422, 423, 424
		Oprijhelling	373, 374, 375, 376, 377, 378, 379, 380, 381, 382, 383, 384, 385
		Oprijplaten	373, 374, 375, 376, 377, 378, 379, 380, 381, 382, 383, 384, 385
		Oprolautomaat	307, 406, 407, 408, 409, 550
		Oprolhaspels	307, 406, 407, 408, 409
		Opspangereedschap draaibank	1032, 1033, 1034, 1035, 1037, 1038, 1039, 1040
		Opsteek steeksleutels	101, 165
		Opsteekadaptor	101, 165
		Opsteek sleutels	101, 165

Opsteekstuk	101, 165
Opvangbak	403, 404, 426, 427, 428, 429, 430, 431
Opvangpallet	403, 404, 426, 427, 428, 429, 430, 431
Overalls	349, 350
Overzetbril	310, 311, 312, 313
P	
Palletwagen	368, 369
Papierhouder	398
Papierrol	398
Papierrolhouder	398
Parallele onderlegblokken	258, 1044, 1045, 1046, 1047, 1048, 1049, 1050, 1051
Parkeerbeugel	425
Partikelfilter	317, 318
Passers	283, 284
Pendrijver	224
Permanente hefmagneten	393
Perslucht cartouchepistool	551, 552, 554, 583
Perslucht gereedschap	551, 552, 554, 583
Perslucht gereedschapsaanrekkers	1032
Perslucht olie	1074
Perslucht taparm	916
Perslucht-beitelhamer	558, 559
Perslucht-blaaspistool	550, 551, 553, 561
Perslucht-handboormachine	553
Perslucht-knabbelschaar	554
Perslucht-slagmoersleutel	107, 555, 556, 557, 558
Perslucht-verfpistool	559, 560, 561
Pet	229
Ph bits	102, 120, 181, 182, 184, 185, 186, 187, 188, 189
Ph schroevendraaier	102, 103, 116, 153, 176, 177, 178, 179, 180, 181, 182
Philips bits	102, 120, 181, 182, 184, 185, 186, 187, 188, 189
Phillips schroevendraaier	102, 103, 116, 153, 176, 177, 178, 179, 180, 181, 182
Pickup en autotools	60, 61, 107, 108, 109, 110, 138, 244, 245, 246, 247, 248, 249, 250, 251
Pijpentang	168
Pijpsleutels	100, 164
Pijpsnijder	208, 234, 235
Pincet	237
Piratenshort	346, 347, 348
Pistolen	551, 552, 554, 583
Plaatschaar	109, 236, 237, 711, 712, 713, 715, 716
Plaatslagershamer	107, 225, 226
Plaatsnijder voor remschijven en plaat	551, 552, 554, 583
Plasma branders	687
Plasma compressor	687
Plasma-snijder op gecompriemde lucht	687
Plasmatoorts	688
Plastic top	693
Plastiek zaag	232
Platbektang	104, 200, 201, 202, 203, 204
Plateau	422, 423, 424
Plateauwagens	366
Platformwagens	366
Platte beitel	224
Platte bits	102, 120, 181, 182, 184, 185, 186, 187, 188, 189
Platte schroevendraaier	102, 103, 116, 153, 176, 177, 178, 179, 180, 181, 182
Platte vijl	110, 239
Plooiachines	716, 717, 719, 720, 721, 722, 723, 724, 725, 726, 727
Plooiroestel	716, 717, 719, 720, 721, 722, 723, 724, 725, 726, 727
Pneumatisch cartouchepistool	551, 552, 554, 583
Pneumatisch gereedschap	551, 552, 554, 583
Pneumatische beitelhamer	558, 559
Pneumatische blaaspistool	550, 551, 553, 561
Pneumatische gereedschapsaanrekkers	1032
Pneumatische handboormachine	553
Pneumatische hefbrug	371
Pneumatische knabbelschaar	554
Pneumatische rolkrik	410, 411, 412, 413
Pneumatische slagmoersleutel	107, 555, 556, 557, 558
Pneumatische slijper	553, 554, 555
Pneumatische taparmen	916
Pneumatische verfpistool	559, 560, 561
Poliermachine	766, 767, 768, 769, 770, 771, 772, 773
Polierschijven	248, 587, 764, 773, 1104, 1105, 1106, 1107, 1108
Polo	359, 360
Polsband	362
Pompwagen	368, 369
Popnageltang	214, 215, 216
Poulietrekkers	218, 219, 220, 221
Powerstretch	354, 355
Pozidriv bits	102, 120, 181, 182, 184, 185, 186, 187, 188, 189
Pozidrivschroevendraaier	102, 103, 116, 153, 176, 177, 178, 179, 180, 181, 182
Precisie kogellagerpers	714
Precisiedraaibank	957, 968, 972, 974, 978, 982, 986, 990, 992
Priemen	107, 228, 229
Productiezaagmachine	780, 781, 787, 788, 789, 790, 791, 792, 794, 795, 796, 798, 800, 802, 804, 806, 808, 810, 812, 814, 816, 818, 820, 822
Profielbuiger	718, 728, 729
Profielbuigmachines	718, 728, 729, 731, 733
Profielbuigroestel	718, 728, 729
Profielmal	271
Profielschaar	715, 716
Publiciteitsmateriaal	229
Puntlasapparaten	684, 685
Puntlasfrees	1078, 1079, 1080, 1081, 1082, 1083
Puntlasinverter	684, 685
Puntlastoestel	684, 685
Punmicrometer	276, 277, 278, 279
Punttang	104, 200, 201, 202, 203, 204
Pvc bakje	547
Pvc geleidingsrollen	586, 587, 589, 592, 593, 595, 597, 598, 599, 601, 607, 612, 616, 619, 621, 626
Pz bits	102, 120, 181, 182, 184, 185, 186, 187, 188, 189
Pz schroevendraaier	102, 103, 116, 153, 176, 177, 178, 179, 180, 181, 182
R	
Raamwaterpas	262, 263, 295
Radiaalboormachine	880, 882, 884, 892, 894, 896, 898, 900, 902, 904, 906, 908, 910
Radiusmallen	271

ALFABETISCHE INDEX

Rails en sjobanden voor rails	394, 395, 396	Schoeisel	340, 341, 342
Ratel verlengstukken	123	Schokdemper	551, 552, 554, 583, 1032
Ratels	101, 120, 121	Schraag	626, 627, 838
Ratelsleutel	101, 120, 121	Schrapsers	229
Ratel-steekringsleutel	99, 100, 156, 157, 158, 159, 160	Schrobzaag	232
Ratellakels	392, 393	Schroefaangedreven compressoren	579
Rechte slijper	553, 554, 555	Schroefbank	258, 539, 1042, 1044, 1045, 1046, 1047, 1048, 1049, 1050, 1051
Rechthoekige vijl	110, 239	Schroefcompressor	579
Reductiehuls	1026, 1027, 1028	Schroefdraad reparatieset	1056
Reflecterende broek	350, 351, 352, 353, 354	Schroefdraadherstelsets	246, 1056
Reflecterende polo	350, 351, 352, 353, 354	Schroefdraadmal	271
Reflecterende regenjas	350, 351, 352, 353, 354	Schroefslutels	101, 167, 168
Reflecterende t-shirt	350, 351, 352, 353, 354	Schroevendraaier dopsleutel	103, 168
Regenbescherming	356, 357	Schroevendraaiers	102, 103, 117, 176, 177, 178, 179, 180, 181, 182, 183, 184
Regenbroek	356, 357	Schroevendraaiers 1000V	103, 117, 183, 184
Regenjas	356, 357	Schroevendraaiers en bitsen	102, 103, 117, 120, 176, 177, 178, 179, 180, 181, 182, 183, 184, 185, 186, 187, 188, 189
Regenkledij	356, 357	Schuifmaat	110, 285, 286, 287, 288, 289
Reiniger onderdelen	400, 401	Schuifpasser	285, 286, 287, 288, 289
Reinigingsmachine	313, 402, 403	Schuinstelbare hydraulische machineklem	258, 1043, 1044, 1045, 1046, 1047, 1048, 1049, 1050, 1051
Reinigingstoestel onderdelen	400, 401	Schuur- en schaafmachines	586, 587, 588, 589, 590, 591, 592, 593, 604
Reinigingstoestellen	658	Schuurbanden	586, 587, 589, 592, 593, 595, 597, 598, 599, 601, 607, 612, 616, 619, 621, 626, 1104, 1105
Reparatiespiegel	250, 251, 264, 265, 266, 267	Schuurmachine	561, 756, 757, 758, 759, 760, 761, 762, 766, 767, 768, 769, 770, 771, 772, 773
Resistente handschoen	336, 337, 339	Schuurmiddelen	1104
Retentiebakken	403, 404, 426, 427, 428, 429, 430, 431	Schuurpapier	1104
Richt- en uitdeukset	414	Schuurschijven	248, 587, 764, 773, 1104, 1105, 1106, 1107, 1108
Riem	361	Seegerringtang	104, 206
Riemaangedreven compressoren	570, 571, 574	Set doorslagen	224
Riemaangedreven kolomboomachines	850, 851, 852, 853, 854, 855, 856, 858, 860, 862, 864, 866, 868, 870, 872, 874, 876, 878	Set draaibeitels	1062, 1063, 1064, 1065, 1066, 1067, 1068, 1069, 1070
Riemen	361	Set matrijs	710, 715, 716, 717, 718, 720, 728, 730, 732, 734, 774
Ringsleutels	100, 160, 161, 162, 163	Set pons	710, 715, 716, 717, 718, 720, 728, 730, 732, 734, 774
Riveteertangen	214, 215, 216, 217	Set sterkabels	643, 644, 645
Rob vierkant bits	102, 120, 181, 182, 184, 185, 186, 187, 188, 189	Set verlengstukken	586, 587, 589, 592, 593, 595, 597, 598, 599, 601, 607, 612, 616, 619, 621, 626
Roestvrij borstel	248	Set zekeringen	643, 644, 645
Roestrijke schaar	237	Signalisatiegilet	350, 351, 352, 353, 354
Rolbok	626, 627, 838	Signalisatielint	416, 417, 418
Rolbokset	586, 587, 589, 592, 593, 595, 597, 598, 599, 601, 607, 612, 616, 619, 621, 626	Sjorband	394, 395, 396
Rolgewalste metaalboor	1078, 1079, 1080, 1081, 1082, 1083	Slagcijfers	290
Rolkriks	410, 411, 412, 413	Slagdoppen	106, 107, 132, 134, 135, 136, 137, 138, 139
Rollenbanen	622, 626, 627, 839, 841, 842	Slagletters	290
Rollerbaan	627, 839, 841, 842	Slagringsleutel	100, 160, 161, 162, 163
Rollerstand	627, 839, 841	Slagschaar	711, 712, 713
Rolmachines	734, 735, 736	Slagschroevendraaier	107, 555, 556, 557, 558
Rolmeter	254, 269, 270, 271	Slangbinding	185, 300, 301, 302, 303
Roltoestel	734, 735, 736	Slanghaspel	307, 406, 407, 408, 409
Rondbektang	104, 200, 201, 202, 203, 204	Slangklemmen	185, 300, 301, 302, 303
Rondborstels	248, 587, 764, 773, 1104, 1105, 1106, 1107, 1108	Sleufkopschroevendraaier	102, 103, 116, 153, 176, 177, 178, 179, 180, 181, 182
Rookmelder	425	Slijpmachines	594, 756, 757, 758, 759, 760, 761, 762, 763, 764, 765, 766, 767, 768, 769, 770, 771, 772, 773, 774
Rug- en polsbescherming	362	Slijpsteen	248, 587, 764, 773, 1104, 1105, 1106, 1107, 1108
Rugbescherming	362		
Rutiel elektrode	688, 689, 690, 691, 692		
Rutiel gecoate laselektrodes	666, 688, 689		
Rutiel inox elektrode	688, 689, 690, 691, 692		
S			
Schaafmessen	710, 715, 716, 717, 718, 720, 728, 730, 732, 734, 774		
Schaar	237		
Schaarhekken	416, 417, 418		
Scharen	237		
Schijfschuurmachine	756, 757, 758, 759, 760, 761, 762		

Smeergereedschap	240, 241, 242, 243
Sneldraaistaal	1061
Snelspanboorhouder	849, 1026
Snelspanboorkop	849, 1026
Snelstarter	638, 639, 640, 641
Snelstarters met transformator	638, 639, 640, 641
Snelwissel adaptor	917
Snijbestendige handschoenen	336
Snijblok met houder	1055, 1056
Snijkiptang	104, 200, 201, 202, 203, 204
Snijkussens	1055
Snijolie	1074
Snijplaat	1055, 1062, 1064, 1065, 1066, 1069, 1072
Snijnspray voor metaal	1075, 1076
Snijtoestel	666
Snijwias voor metaal	1075, 1076
Snoeihandschoenen	338, 339
Softshells	354, 355
Soldeergereedschap	693
Soundlevelmeter	261
Soundtest	261
Spaanopname-apparaat	1032
Spaanoprapers	1032
Span riem	394, 395, 396
Spanband	394, 395, 396
Spandoek	229
Spanningsdetector	289
Spanningsmeter	280, 281, 282
Spanningstesters	289
Spantangen	1029, 1030, 1032, 1033
Spantangenhouder	1029
Spantangenset	1029, 1030
Spantanghouder	1029, 1030
Spanvijen	209
Speed-houtboreset	246, 1083, 1084, 1085
Speermicrometer	276, 277, 278, 279
Spijkerlang	104, 200, 201, 202, 203, 204
Spiraal slang	551, 552, 554, 583
Spool gun	673, 674, 675
Spouwmes	586, 587, 589, 592, 593, 595, 597, 598, 599, 601, 607, 612, 616, 619, 621, 626
Staafelektroden	666, 688, 689
Staaldraad borstel	248
Staalplaatschaar	715, 716
Staande boormachine	850, 851, 852, 853, 854, 855, 856, 858, 860, 862, 864, 866, 868, 870, 872, 874, 876, 878
Stand	626, 627, 838
Standboormachine	850, 851, 852, 853, 854, 855, 856, 858, 860, 862, 864, 866, 868, 870, 872, 874, 876, 878
Stapbescherming	420, 421, 422
Startboosters	642, 643, 646, 647
Starters	642, 643, 646, 647
Stationaire compressoren	576, 577
Statusweergave batterijen	644
Steekringsleutels	99, 100, 156, 157, 158, 159, 160
Steeksleutels	163, 164
Steekwagens	366, 367, 370
Steenboor	246, 1078, 1079, 1080, 1081, 1082, 1083, 1084, 1085
Stempelsets	290
Stenen slijpen	553, 554, 555
Sternband	416, 417, 418
Steunblok	294, 710
Stickers	229
Stiftsleutel	101, 169, 170, 171, 173
Stoffen handschoen	337, 338
Stofzuiger	658
Stofzuigers- en spaanderzuigers	617, 618, 620
Stokpasser	283, 284
Stroommeter	280, 281, 282
Stroomvormers	645
Struikelbescherming	420, 421, 422
Studder box	686
Sweater	360, 361
Switch box	586, 587, 589, 592, 593, 595, 597, 598, 599, 601, 607, 612, 616, 619, 621, 626
T	
Tachometers	290, 291
Tafelboormachine	850, 851, 852, 853, 854, 855, 856, 858, 860, 862, 864, 866, 868, 870, 872, 874, 876, 878
Tafelcirkelzaagmachine	778, 779, 780, 781, 783, 784
Tafelplaatschaar	711, 712, 713
Tafelschaar	711, 712, 713
Tafelslijper	766, 767, 768, 769, 770, 771, 772, 773
Tafelvoeding langs	1031
Takel	386
Takelhouder	386
Tandkrans boorhouder	849, 1026
Tandwiel aangedreven kolomboormachines	880, 882, 884, 886, 888, 890, 892, 894, 896, 898, 900, 902, 904, 906, 908, 910, 912
Tangen	104, 105, 200, 201, 202, 203, 204, 205, 206, 207, 208, 209
Tangen 1000V	104, 204, 205
Tapapparaat	1041
Tapdop	125, 126, 128, 129, 130, 131
Taphouder	1041, 1055, 1056
Tappen	1054
Tappen- en kussensets	108, 1057, 1058, 1059
Tappotten	917
Telefoontang	104, 200, 201, 202, 203, 204
Telescopische pick-up magneet	250, 251, 264, 265, 266, 267
Telescopische spiegel	250, 251, 264, 265, 266, 267
Terugslagventiel	551, 552, 554, 583
Terugslagvrije hamer	107, 225, 226
Tester	289, 644
Textielhandschoenen	337, 338
T-gleufgeschermer	1031
T-greep	122
T-handvat	122
T-hemd	359
T-hendel	122
T-hendels	122
Therm드릴	1089, 1090
Thermometers	282, 291, 292
Tig lasapparaten	679, 680, 681, 682
Tig toortsen	683
Tindraad	693
Tinfrezenset	1060
Tinopneerpomp	693
Titanium trapboren	246, 1083, 1084, 1085
Toegangsdrempel	422, 423, 424
Toegangsplateau	422, 423, 424
Toerentameter	290, 291
Toerenteller	290, 291
Toestel met stralingswarmte	650, 651, 652

ALFABETISCHE INDEX

Tooljassen	354	Veiligheidsbril met zonnebescherming	310, 311, 312, 313
Torenfreesmachine	938, 940, 942, 944, 946, 948, 950	Veiligheidsbrillen	310, 311, 312, 313
Torxschroevendraaier	101, 171, 173	Veiligheidsbroek	350, 351, 352, 353, 354
Torxslutels	101, 171, 173	Veiligheidscabine boormachine	1022, 1023
T-profiel schroevendraaier	102, 103, 116, 153, 176, 177, 178, 179, 180, 181, 182	Veiligheidscabine draaibank	1024, 1025
Transfersticker	229	Veiligheidscabine freesmachine	1023
Transfo elektrodelasapparaten	664, 665	Veiligheidskast boormachine	1022, 1023
Transmissiekris	413	Veiligheidsjas	350, 351, 352, 353, 354
Transpalletwagen	368, 369	Veiligheidskapjes	688
Transportband	627, 839, 841, 842	Veiligheidskast boormachine	1023
Transportmateriaal	366, 367, 368, 369, 370, 371	Veiligheidskast draaibank	1024, 1025
Transportrollen	369, 370	Veiligheidsmarkering	420
Transportwagen	366, 367, 370	Veiligheidsmasker	317, 318
Trapboor	1078, 1079, 1080, 1081, 1082, 1083	Veiligheidspull	350, 351, 352, 353, 354
Trechter voor opvangbakken	403, 404, 426, 427, 428, 429, 430, 431	Veiligheidsschoenen	340, 341, 342
Trekmagneet	393	Veiligheidsspiegel	425
Trektang	104, 200, 201, 202, 203, 204	Veiligheidssweater	350, 351, 352, 353, 354
Trillingsdemper	551, 552, 554, 583, 1032	Veiligheidst-shirt	350, 351, 352, 353, 354
Trillingsisolatie	1032	Veiligheidsuitrusting	330, 331, 332, 336, 337, 339, 340, 341, 342, 362
Trillingsmeter	292	Veiligheidsventiel	551, 552, 554, 583
Trilmeter	292	Veiligheidsvest	350, 351, 352, 353, 354
Trui	360, 361	Velcro schuurschijf	248, 587, 764, 773, 1104, 1105, 1106, 1107, 1108
T-shirt	229, 359, 360, 361	Ventilatie	656, 657
Tuinhandschoenen	338, 339	Ventilatoren	656, 657
Tx schroevendraaier	102, 103, 116, 153, 176, 177, 178, 179, 180, 181, 182	Ventilatorgekoeld lasapparaat	667, 668
U		Verbindingsringen afsluitketting	416, 417, 418
Uitdeuksets	414	Verbindingsstuk	122, 123
Uitdrijfspeen	1026	Verbruiksartikel lasapparaat	688, 689, 690, 691, 692
Uitdrijvers	1026	Veren voor zwanehals	673, 674, 675
Uithoekscharen	738	Verf pistool	559, 560, 561
Uitschuifmes	109, 233, 234	Verfpistoolreiniger	400, 401
Ultrasoonreinigers	399	Verfspuit	559, 560, 561
Umbraco	101, 169, 170, 171, 173	Verfspuitmasker	317, 318
Universeelmeter	280, 281, 282	Vergroothuls	1027
Universele gradenboog	262, 263	Verkeersdrempels	422, 423, 424
Universele kasten	542	Verkeerskegel	416, 417, 418
Universele reiniger	400, 401	Verkeersplateau	422, 423, 424
V		Verkeersspiegel	425
V blok	294, 710	Verleng- en vergroothuls	1027
Vacuümreiniger	658	Verlenghuls	1027
Vakverdeling	53, 94, 95, 96, 97, 98, 99, 100, 101, 102, 103, 104, 105, 106, 107, 108, 109, 110, 181	Verlenglens	310, 311, 312, 313
Valbescherming	364	Verlengstukken	123
Vaste bril	1033	Verlichtingsmateriaal	304, 305, 306, 307
Vaste lendenband	362	Verloopstuk kernboren	1026
Vaste snijpasta voor metaal	1075, 1076	Verloopstuk magneetboormachine	1026
Vastzetsysteem	586, 587, 589, 592, 593, 595, 597, 598, 599, 601, 607, 612, 616, 619, 621, 626	Verrijdbaar onderstel	366
Vatenkarretje	431	Verstelbare moersleutel	101, 167, 168
Vatenlift	431	Verstelbare momentsleutel	105, 192, 194, 195, 196, 197
V-blokken	294, 710	Verstelbare winkelhaak	296, 297, 298
VDE schroevendraaier	103, 183, 184	Vervangglazen	314, 316
Veertrillingsdemper	1032	Vervangmatrijzen	710, 715, 716, 717, 718, 720, 728, 730, 732, 734, 774
Veiligheidsafscherming voor boormachines	1022, 1023	Vervangmessen	586, 587, 589, 592, 593, 595, 597, 598, 599, 601, 607, 612, 616, 619, 621, 626, 710, 715, 716, 717, 718, 720, 730, 734, 774
Veiligheidsafscherming voor draaibanken	1024, 1025	Vervangscherm	313
Veiligheidsafscherming voor freesmachines	1023	Vervangstuk poulietrekker	221
Veiligheidsbescherming boormachine	1022, 1023	Verwarming	653, 654
Veiligheidsbescherming draaibank	1024, 1025	Verwarming met ventilator	655
Veiligheidsbescherming freesmachine	1023	Verwarmingstoestellen	650, 651, 652, 653, 654, 655, 656, 657
		Verzinkboren	246, 1078, 1079, 1080, 1081, 1082, 1083, 1084, 1085

Verzinkte ketel	551, 552, 554, 583
Vibratiemeter	292
Vibrometer	292
Vierkante vijl	110, 239
Vierklauw	1037, 1038, 1039, 1040
Vijlen	110, 239
Vijlen slijpen	553, 554, 555
Vise à gripe	105, 206, 207, 208
Vlakfrees	1061
Vlakfrees opnamehouder	1028
Vlakfrees opsteekfreesdoorn	1028
Vlakfreeshouder	1028
Vlaktafels	292
Vlamvertragende broek	425
Vlamvertragende jas	425
Vlamvertragende overall	425
Vlamvertragende vest	425
Vleugelmoer slangklem	185, 300, 301, 302, 303
Vloeboren	1089, 1090
Voedingsmotor	1031
Voelermaten	292, 293, 294
Voetbescherming	340, 341, 342
Voetjespasser	283, 284
Voetknipschaar	711, 712, 713
Voetveiligheid	340, 341, 342
Volmeetapparaat	280, 281, 282
Voorhoofdbescherming	313
Voorzetteray	403, 404, 426, 427, 428, 429, 430, 431
W	
Wader	356, 357
Walsenset	710, 715, 716, 717, 718, 734, 728, 730, 732, 734, 774
Walstoestel	734, 735, 736
Wandkast	64, 65, 516, 518, 519, 520, 522, 524, 525, 526, 527, 528, 529, 530, 531
Wandkasten	538, 539
Wandpanelen	538, 539
Wandrek	117
Warmeluchtblazer	653, 654
Warmeluchtblazer op propaangas	655
Warmeluchtblazers met ventilator	653, 654
Warmteblazer	653, 654, 655
Waterafscheider	582, 583
Waterafstotende jas	354, 355, 356, 357
Waterdichte jas	356, 357
Waterpassen	262, 263, 295
Waterpomptang	104, 200, 201, 202, 203, 204
Waterzuigers	658
Wegwerphandschoen	339
Wegwerpmasker	317, 318
Wegwerpoordopjes	318, 319, 320
Wegweroverall	349, 350
Werkkist	544, 545, 546
Werkkoffer	544, 545, 546
Werklamp	304, 305, 306, 307
Werklicht	304, 305, 306, 307
Werkbanken	496, 497, 498, 499, 500, 502, 504, 505, 506, 510, 511, 512, 513, 514, 515, 517, 532, 533, 534, 535, 536, 537, 624, 626, 627
Werkbanklijper	766, 767, 768, 769, 770, 771, 772, 773
Werkbroek	346, 347, 348, 350, 351, 352, 353, 354
Werkhandschoenen	330, 331, 332, 333, 334, 336, 337, 339
Werkjassen	354
Werkkist	544, 545, 546
Werkkledij	346, 347, 348, 349, 350, 354, 355, 356, 357, 358, 359, 360, 361
Werkkleding	340, 341, 342, 346, 347, 348, 349, 350, 354, 355, 356, 357, 358, 359, 360, 361
Werkkoffer	77, 79, 85
Werklamp	304, 305, 306, 307
Werklampen	304
Werklicht	304, 305, 306, 307
Werkplaatsbank	496, 497, 498, 499, 500, 502, 504, 505, 506, 510, 511, 512, 513, 514, 515, 517
Werkplaatskast	484, 486, 487, 488, 489, 490, 491, 492, 493, 494, 495
Werkplaatskranen	414, 415
Werkplaatsladekast	484, 486, 487, 488, 489, 490, 491, 492, 493, 494, 495
Werkplaatsmeubilair	60, 64, 65, 434, 435, 436, 437, 438, 440, 441, 442, 444, 446, 447, 448, 449, 450, 451, 452, 456, 460, 462, 463, 464, 466, 467, 468, 470, 471, 472, 474, 475, 476, 478, 479, 480, 482, 483, 484, 486, 487, 488, 489, 490, 491, 492, 493, 494, 495, 496, 497, 498, 499, 500, 502, 504, 505, 506, 510, 511, 512, 513, 514, 515, 516, 517, 518, 519, 520, 522, 524, 525, 526, 527, 528, 529, 530, 531, 532, 533, 534, 535, 536, 537, 538, 539, 540, 541, 542, 543, 544, 545, 546, 547, 548
Werkplaatstafel	496, 497, 498, 499, 500, 502, 504, 505, 506, 510, 511, 512, 513, 514, 515, 517
Werkplaatsuitrusting	544, 545, 546
Werkplaatswagen	52, 53, 54, 55, 56, 57, 58, 59, 63, 64
Werkshoes	340, 341, 342
Werkshort	346, 347, 348
Werkstukaandrukkers	258, 539, 1043, 1044, 1045, 1046, 1047, 1048, 1049, 1050, 1051
Werkstukaanslagen	258, 539, 1044, 1045, 1046, 1047, 1048, 1049, 1050, 1051
Werkstukklemming tafel	258, 539, 1042, 1043, 1044, 1045, 1046, 1047, 1048, 1049, 1050, 1051
Werkstukstoppers	586, 587, 589, 592, 593, 595, 597, 598, 599, 601, 607, 612, 616, 619, 621, 626
Werktafel	52, 53, 54, 55, 56, 57, 58, 59, 63, 64, 496, 497, 498, 499, 500, 502, 504, 505, 506, 510, 511, 512, 513, 514, 515, 517
Werkvest	354
Wielsleutel	122
Winddichte jas	354, 355
Winkelhaak	296, 297, 298
Winterhandschoen	335
Winterkledij	356
Winteroverall	349, 350
Wisselplaat	1062, 1064, 1065, 1066, 1069, 1072
Wringijzer voor tappen	1055, 1056
Z	
Zaagbladen	586, 587, 589, 592, 593, 597, 599, 607, 612, 616, 619, 621, 626, 1094, 1095
Zaagbok	626, 627, 838
Zaagmachines	597, 598, 599, 600, 601, 603, 606, 608, 609, 610, 778, 779, 780, 781, 783, 784
Zaklamp	305
Zandstraalcabines	402, 403
Zelfcenterende klauwplaat	1037, 1038, 1039
Zelfcenterende machineklemmen	1045

NUMERIEKE INDEX

Order nr.	Pag.	Order nr.	Pag.	Order nr.	Pag.	Order nr.	Pag.	Order nr.	Pag.
01101708	123	100076013	213	101790905	171	102070505	127	105881304	225
01101807	123	100076014	213	101792000	171	102070604	127	105881403	225
01101906	123	100076015	213	101792100	171	102070703	127	105900205	270
01102003	123	100240100	185	101792208	171	102070802	127	105900306	270
01102102	123	100690106	228	101792307	171	102070901	127	105900407	270
01102201	123	100690106	108	101792406	171	102080108	127	105910103	234
012200028	364	101030203	94	101792505	171	102080207	127	105930051	204
012200127	364	101075145	1042	101792604	171	102080306	127	105930077	204
012200135	364	101530103	98	101800050	173	102080405	127	105930101	204
012201315	364	101540102	98	101800100	173	102080504	127	106040108	186
012201323	364	101540201	98	101800209	173	102080603	127	106040207	186
012200018	364	101660108	161	101800308	173	102080702	127	106040306	186
012220026	364	101670057	123	101800407	173	102080801	127	106040405	186
012300059	320	101670107	123	101800506	173	102080900	127	106040504	186
013220777	362	101670206	123	101800605	173	102090107	128	106040603	186
03050101	124	101690105	127	101800704	173	102090206	128	106040702	186
03120102	133	101690204	127	101800803	173	102090305	128	106041007	186
03120201	133	101690303	127	101800902	173	102090404	128	106041106	186
03130101	229	101690402	127	101801009	173	102090503	128	106041205	186
03270204	62	101690501	127	101850105	125	102090602	128	106041403	186
03420204	62	101700102	164	101850204	125	102090701	128	106041601	186
03450103	56	101700201	164	101850303	125	102090800	128	106050107	186
03450202	249	101700300	164	101850402	125	102090909	128	106050206	186
03490109	96	101700409	164	101850501	125	102100104	107	106050305	186
03520103	96	101700508	164	101860104	187	102100104	133	106050404	186
03570108	96	101700607	164	101860203	187	102100203	134	106050503	186
03570207	97	101700706	164	101860302	187	102110104	192	106051006	186
03570256	97	101700805	164	101860401	187	102110104	105	106051105	186
03570306	97	101700904	164	101860500	187	102120102	167	106051204	186
03691458	1026	101701001	164	101860609	187	102120102	100	106051303	186
03691755	1026	101701100	164	101860708	187	102140100	97	106060106	186
03890100	94	101710101	152	101860807	187	102150109	181	106060205	186
03900107	100	101780021	136	101860906	187	102151008	181	106060304	186
03900107	163	101780039	136	101861003	187	102151107	181	106060403	186
03960101	108	101780062	136	101870103	188	102151206	181	106060502	186
03960101	245	101780096	136	101870202	188	102151305	181	106060601	186
03980109	108	101780104	136	101870301	188	102151404	181	106070105	186
03980109	218	101780153	136	101870400	188	102151503	181	106070204	186
04030102	205	101780203	136	101870509	188	102180106	151	106070303	186
04030102	104	101780302	136	101870608	188	102300100	267	106070402	186
04160107	94	101780401	136	101870707	188	102300209	268	106070501	186
04160206	94	101780500	136	101870806	188	102360104	285	106080104	186
04200101	250	101780609	136	101870905	188	102369150	285	106080203	186
04850103	152	101780633	136	101871002	188	102380102	278	106080302	186
06790109	123	101780658	136	101880102	187	102610102	184	106081003	186
06790158	123	101780708	136	101880201	187	102620101	184	106081102	186
06790208	123	101780757	136	101880300	187	102630100	184	106081201	186
06790307	123	101780807	136	101880409	187	103900106	273	106090103	187
06790356	123	101780815	136	101880508	187	104450101	181	106090202	187
06790406	123	101780823	136	101880607	187	104450101	102	106090301	187
06790455	123	101780831	136	101880706	187	105270660	304	106090400	187
06790505	123	101780849	136	101880805	187	105270661	304	106090509	187
06790604	123	101780856	136	101880904	187	105270663	304	106100100	186
06790703	123	101780864	136	101881001	187	105270664	304	106100209	186
07490055	295	101780872	136	101890101	188	105810105	226	106100308	186
07490154	295	101780930	137	101890200	188	105810204	226	106100407	186
07490204	295	101780963	137	101890309	188	105820104	169	106100506	186
07490402	295	101780997	137	101890408	188	105820203	169	106100605	186
07570039	295	101781003	137	101890507	188	105830103	171	106110109	187
07570054	295	101781052	137	101890606	188	105840102	162	106110208	187
07570104	295	101781102	137	101890705	188	105840201	162	106110307	187
07570203	295	101781201	137	101890804	188	105840227	162	106110406	187
08700106	204	101781300	137	101890903	188	105840243	162	106120108	187
100070024	213	101781409	137	101891000	188	105840268	162	106120207	187
100070050	213	101781508	137	101900108	234	105840300	162	106120306	187
100071090	210	101781557	137	101900207	234	105860100	233	106120405	187
100071100	211	101781607	137	101900306	234	105860209	233	106120504	187
100071200	212	101781706	137	101900405	234	105860308	233	106120603	187
100071300	212	101781805	137	101900504	234	105861108	233	106120702	187
100071500	212	101781904	137	101901007	234	105861207	233	106120801	187
100071550	212	101782001	137	101901106	234	105870059	167	106120900	187
100071600	212	101782100	137	101901205	234	105870109	167	106121007	187
100071907	210	101782209	137	101901304	234	105870208	167	106121106	187
100072004	212	101782308	137	101901403	234	105870307	167	106130107	188
100072045	212	101782407	137	101910107	182	105870406	167	106130206	188
100072188	211	101790053	171	101920106	207	105870505	167	106130305	188
100073050	213	101790103	171	101920205	207	105870604	167	106130404	188
100073120	213	101790202	171	101930105	207	105870703	167	106130503	188
100073300	213	101790301	171	101940104	208	105880058	225	106130602	188
100073500	211	101790400	171	101950103	208	105880108	225	106130701	188
100076000	213	101790509	171	102070109	127	105880207	225	106130800	188
100076010	213	101790608	171	102070208	127	105880306	225	106130909	188
100076011	213	101790707	171	102070307	127	105881106	225	106131006	188
100076012	213	101790806	171	102070406	127	105881205	225	106131105	188

Order nr.	Pag.	Order nr.	Pag.	Order nr.	Pag.	Order nr.	Pag.	Order nr.	Pag.
106140106	188	109730101	158	112070800	130	114870900	136	114931207	131
106140205	188	109730101	99	112070909	130	114871007	136	114931306	131
106140304	188	109730200	158	112260104	169	114872005	137	114931405	131
106140403	188	109730200	99	112260203	169	114872104	137	114931504	131
106140502	188	109740100	201	112270103	250	114872203	137	114931603	131
106140601	188	109740209	201	112270103	264	114872302	137	114931702	131
106140700	188	109750109	201	112280102	250	114872401	137	114960107	132
106141005	188	109750208	201	112280102	264	114872500	137	114960206	132
106141104	188	109750307	201	112290101	251	114872609	137	116480104	134
106141203	188	109760108	201	112290101	264	114872708	137	116480203	134
106141401	188	109770107	202	112310107	245	114872807	137	116480302	134
106141500	188	109770206	202	112310156	245	114872906	137	116480401	134
106141609	188	109770305	202	112310206	245	114873003	137	116480500	134
106150105	188	109780106	202	112310255	245	114873102	137	116480609	134
106150204	188	109780205	202	112310305	245	114880107	139	116480708	134
106150303	188	109790105	202	112310404	245	114880156	139	116480807	134
106160104	185	109800102	203	112440102	53	114880172	139	116480906	134
106160203	185	109820101	104	112440203	53	114880198	139	116481003	134
106170103	185	109820101	200	112520101	104	114880206	139	116481102	134
106180102	186	110100010	279	112520101	205	114880305	139	116481201	134
106180201	186	110100018	279	112540109	61	114880404	139	116490103	160
106180300	186	110100035	279	112550108	59	114880503	139	116490202	160
106190101	110	110100050	279	112660105	62	114880602	139	116490301	160
106210107	95	110100100	279	112680103	168	114880701	139	116490400	160
106230105	105	110100160	279	112680202	168	114880800	139	116490509	160
106230105	206	110100250	279	112680301	168	114880909	139	116490608	160
106280100	186	110230109	62	112680400	168	114881006	139	116490707	160
106281009	186	110380102	107	112680509	168	114881105	139	116490806	160
107540106	234	110380102	210	112680608	168	114881204	139	116490905	160
107540205	235	111730107	186	112680707	168	114890106	139	116491002	160
109070058	213	111730305	186	112680806	168	114890155	139	116491101	160
109070828	212	111730354	186	112680905	168	114890171	139	116491200	160
109090050	286	111730503	186	112700109	205	114890197	139	116500703	160
109090100	286	111730602	186	112700109	104	114890205	139	116500901	160
109090209	286	111960100	161	114590102	178	114890304	139	116510108	158
109100107	286	111960209	161	114590102	168	114890403	139	116510207	158
109290031	299	111960308	161	114590102	103	114890502	139	116510306	158
109290056	299	111960407	161	114640105	53	114890601	139	116510405	158
109290072	299	111960506	161	114640105	94	114890700	139	116510504	158
109290098	299	111960605	161	114820103	127	114890809	139	116510603	158
109290197	299	111960704	161	114820202	127	114890908	139	116510702	158
109420109	204	111960803	161	114820301	127	114891005	139	116510801	158
109420208	204	111960902	161	114820400	127	114891104	139	116510900	158
109450106	94	111961009	161	114820509	127	114900103	139	116511007	158
109460105	109	111961108	161	114820608	127	114900202	139	116520107	160
109460105	250	111990107	165	114820707	127	114900301	139	116560103	170
109470104	158	112010103	165	114820806	127	114900400	139	116560202	170
109470104	99	112010202	165	114830102	136	114900509	139	116560301	170
109480103	61	112010301	165	114830201	136	114900608	139	116560400	170
109550103	169	112010400	165	114830300	136	114900707	139	116560509	170
109550202	169	112010509	165	114830409	136	114900806	139	116560608	170
109600304	289	112010608	165	114830508	136	114900905	139	116560707	170
109690107	187	112010707	165	114830607	136	114901002	139	116560806	170
109690206	187	112010806	165	114830706	136	114901101	139	116560905	170
109690305	187	112010905	165	114830805	136	114901200	139	116561002	170
109690404	187	112011002	165	114830904	136	114901309	139	116561101	170
109690503	187	112012000	165	114840101	131	114901408	139	116561200	170
109720102	159	112012208	165	114840200	131	114901507	139	116561309	170
109720201	159	112012505	165	114840309	131	114901606	139	116561408	170
109720300	159	112020102	167	114840408	131	114901705	139	116561507	170
109720409	159	112020201	167	114840507	131	114901804	139	116561606	170
109720508	159	112020300	167	114840606	131	114901903	139	116561705	170
109720607	159	112030101	167	114840705	131	114902000	139	116561804	170
109720706	159	112030200	167	114840804	131	114910102	139	116561903	170
109720805	159	112030309	167	114840903	131	114910201	139	116562000	170
109720904	159	112030408	167	114841000	131	114910300	139	116570102	170
109721001	159	112030507	167	114841109	131	114910409	139	116570201	170
109721100	159	112030606	167	1148460109	136	114910508	139	116570300	170
109721209	159	112040100	122	114860208	136	114910607	139	116570409	170
109721308	159	112040209	122	114860307	136	114920101	139	116570508	170
109721407	159	112060108	126	114860406	136	114920200	139	116570607	170
109721506	159	112060207	126	114860505	136	114920309	139	116570706	170
109721605	159	112060306	126	114860604	136	114920408	139	116570805	170
109721704	159	112060405	126	114860703	136	114930100	131	116570904	170
109722009	159	112060504	126	114860802	136	114930209	131	116571001	170
109722108	159	112060603	126	114860901	136	114930308	131	116571100	170
109722207	159	112060702	126	114870108	136	114930407	131	116571209	170
109722306	159	112070107	130	114870207	136	114930506	131	116571308	170
109722405	159	112070206	130	114870306	136	114930605	131	116571407	170
109722504	159	112070305	130	114870405	136	114930704	131	116600107	171
109722603	159	112070404	130	114870504	136	114930803	131	116610104	172
109722702	159	112070503	130	114870603	136	114930902	131	116660101	151
109722801	159	112070602	130	114870702	136	114931009	131	116690058	135
109722900	159	112070701	130	114870801	136	114931108	131	116690108	134

NUMERIEKE INDEX

Order nr.	Pag.	Order nr.	Pag.	Order nr.	Pag.	Order nr.	Pag.	Order nr.	Pag.
116690207	134	117020909	224	118110105	227	121951115	269	128141108	138
116690405	135	117021006	224	118110204	227	121951519	269	128141207	138
116690504	135	117021105	224	118110303	227	121951923	269	128170107	286
116690603	135	117021204	224	118120203	182	121952030	269	128201001	121
116690702	134	117030106	225	118120302	182	121952327	269	128210101	101
116690801	134	117030205	225	118120401	182	121952731	269	128210101	120
116690850	134	117030304	225	118120500	182	121953070	269	128220100	105
116690900	134	117031005	225	118120609	182	121953135	269	128220100	124
116691007	134	117031104	225	118120708	182	121957011	269	128230109	117
116691106	135	117031203	225	118120807	182	122010150	284	128240108	117
116691205	134	117060103	95	118120906	182	122010200	284	128250107	101
116691304	134	117070102	151	118190107	244	122010250	284	128250107	169
116691403	134	117090209	151	118250109	232	122010300	284	128260106	171
116691502	134	117110106	123	118260108	233	122060106	192	128260205	171
116700105	162	117110205	123	118300102	165	122070105	124	128270105	117
116700105	100	117150102	52	118340108	120	122070204	124	128300100	207
116710104	162	117391151	121	118340108	185	122070303	124	128310109	208
116710203	162	117391250	121	118350107	132	122070402	124	128320108	208
116710302	162	117391409	121	118350206	132	122070808	124	128330107	117
116710401	162	117400101	130	118350305	132	122070857	124	128360104	209
116710500	162	117400200	130	118360205	164	122070907	124	128360203	209
116710609	162	117400309	130	118360403	164	122070956	124	128360302	209
116740051	135	117400408	130	118360502	164	122080104	106	128360401	209
116740085	135	117400507	130	118360809	164	122080104	133	128360500	209
116740101	135	117400606	130	118360908	164	122090103	122	128370103	209
116740200	135	117400705	130	118361104	164	122090103	97	128370202	209
116740309	135	117400804	130	118361203	164	122160104	55	128370301	209
116740333	135	117400903	130	118380104	165	122170103	56	128370400	209
116740358	135	117440107	130	118380104	101	122180102	57	128370509	209
116740382	135	117440206	130	118400100	100	122190101	55	128390101	211
116740408	135	117440305	130	118400100	164	122240104	61	128400108	239
116740507	135	117440404	130	118420108	107	122250103	61	128420106	218
116740606	135	117440503	130	118420108	244	122260102	224	128430105	110
116740705	135	117440602	130	118470103	249	122360100	54	128430105	239
116750050	135	117440701	130	118470103	60	122370109	54	128440104	110
116750084	135	117440800	130	118870104	132	122380108	58	128440104	239
116750100	135	117440909	130	118890102	98	122390107	75	128490109	239
116750209	135	117441006	130	118900109	153	122400104	73	128520103	239
116750308	135	117450106	129	118910108	153	122400104	82	128530102	239
116750357	135	117450205	129	119080208	273	122440100	107	128540101	239
116750407	135	117450304	129	119081008	273	122440100	225	128550100	239
116750506	135	117450403	129	119090108	285	122470107	210	128560109	282
116760059	201	117450502	129	119110104	273	122470107	107	128580107	281
116760158	201	117450601	129	119110203	273	122480106	105	128590106	281
116760208	201	117490102	104	119120103	273	122480106	206	128590205	282
116760307	201	117490102	204	119130102	274	122490105	105	128600103	282
116770158	203	117560102	59	119130201	274	122500101	105	128600202	282
116780107	206	117570101	52	119150100	260	122500101	192	128600301	292
116790106	250	117580100	204	119160109	260	122560105	288	128600301	282
116820101	214	117590109	205	119170108	260	122580103	262	128650108	178
116830100	1055	117610105	205	119180107	297	122590102	286	128650108	102
116830209	1055	117610204	205	119190106	262	122690100	170	128650207	178
116830308	1055	117620104	205	120110075	296	122690209	170	128650306	178
116830407	1055	117630103	205	120110100	296	122690308	170	128650405	178
116830506	1055	117690107	107	120110150	296	122690407	170	128650504	178
116830605	1055	117690107	228	120110200	296	122690506	170	128650603	178
116830704	1055	117690206	229	120110250	296	122690605	170	128650702	178
116831009	1055	117690305	228	120110300	296	122690704	170	128650801	178
116831108	1055	117720102	303	120110400	296	122690753	170	128650900	178
116831207	1055	117720102	185	120110500	296	122690803	170	128651007	178
116831306	1055	117730101	244	120110750	298	122690902	170	128651106	178
116831405	1055	117730200	244	120600101	277	123000152	289	128651205	178
116831504	1055	117730309	244	121700075	294	123040100	278	128651304	178
116831603	1055	117760108	251	121700100	294	127810109	279	128660107	117
116840208	122	117780106	245	121700150	294	127810208	279	128670106	247
116860107	293	117860106	108	121800045	294	127810307	279	128670205	247
116930108	246	117860106	227	121800070	294	127810406	279	128680105	247
116940107	1056	117870105	226	121800071	294	127810505	279	128690104	247
116950106	247	117870204	226	121800125	294	127810604	279	128700101	247
116960105	247	117880104	60	121870300	295	127810703	279	128710100	247
116960204	247	117880203	60	121900100	269	127820108	279	128720109	247
116960303	247	117890103	245	121900150	269	127820207	279	128730108	58
116960402	247	117890301	245	121900200	269	128130101	106	131490105	244
116970104	247	117900100	225	121900250	269	128130101	133	131560104	291
116980103	228	117900209	226	121900300	269	128140100	138	131890105	159
116980202	228	117900308	226	121900500	269	128140209	138	131890204	159
116980301	228	117920108	246	121901000	269	128140308	138	131890303	159
116990201	226	117970103	244	121902000	269	128140407	138	131890402	159
117020107	224	118000108	244	121920500	269	128140506	138	131890501	159
117020206	224	118010107	244	121923000	269	128140605	138	131890600	159
117020305	224	118010206	244	121925000	269	128140704	138	131890709	159
117020404	224	118060102	121	121930300	269	128140803	138	131890808	159
117020503	224	118060201	121	121930500	269	128140902	138	131890907	159
117020602	224	118090109	245	121941519	269	128141009	138	131891004	159

Order nr.	Pag.	Order nr.	Pag.	Order nr.	Pag.	Order nr.	Pag.	Order nr.	Pag.
131891103	159	143870061	195	145010104	289	154910202	156	161780101	95
131891202	159	143870087	195	149870107	134	154910301	156	161780200	95
131900102	159	143870103	195	149870206	134	155310105	1074	161790100	94
131900102	99	143870202	195	149870305	134	155310303	1074	161790209	94
131910101	218	143870301	195	149870404	134	155320104	1074	161790308	94
131920100	270	143870400	195	149870503	134	155350101	1074	161800107	95
131920209	270	143870657	196	151250107	297	155420102	1074	161800206	95
131920308	270	143870756	196	151250206	297	155470206	1076	161800305	95
132090101	120	143870806	196	151270105	262	155500200	1076	161800310	210
132100108	142	143870905	196	151280104	272	155560204	241	161800406	241
132150103	98	143870954	196	151290103	272	155560303	241	161810056	195
132180100	168	143880102	98	151290202	272	155580103	241	161810106	195
132180209	168	143890101	101	151300100	274	15580103	165	162460208	298
132180308	168	143890101	166	151300209	274	15610108	249	162550107	153
132180407	168	143930105	218	151300308	274	15610108	60	162560106	152
132180506	168	143930204	218	151340106	59	160380051	168	162590103	123
132180605	168	143930303	218	151350105	59	160380101	168	162610109	123
132180704	168	143930402	218	151410107	106	160380200	168	162610208	123
132180803	168	143930501	218	151410107	133	160380309	168	162620108	55
132180902	168	143980100	139	151420106	138	160390100	236	162630107	57
132181009	168	143980209	139	151420205	138	160690103	106	162640106	170
132181108	168	143980308	139	151420304	138	160690103	133	162650105	171
132220104	246	143990109	130	151420403	138	160700100	120	162670103	169
132230103	134	143990208	130	151420502	138	160700209	120	162680102	159
132230202	134	143990307	130	151420601	138	160700308	120	162680201	159
132230301	134	143990406	130	151420700	138	160701009	121	162680300	159
132330101	288	143990505	130	151420809	138	160701108	121	162680409	159
132350109	257	143990604	130	151430105	135	160701207	121	162680508	159
132360108	259	143990703	130	151430204	135	160720108	135	162680607	159
132370107	290	143990802	130	151430303	135	160720207	135	162680706	159
132370206	290	144000106	130	151430402	135	160720300	135	162680805	159
132370305	290	144000205	130	151430501	135	160720405	135	162680904	159
132390105	305	144000304	130	151430600	135	160720504	135	162681001	159
132430109	135	144000403	130	151430709	135	160730107	60	162681100	159
132430208	135	144000502	130	151440104	110	160740106	163	162681209	159
132430307	135	144000601	130	151460102	246	160740205	163	165350109	91
132430406	135	144000700	130	151460201	246	160740304	163	165840109	62
132430505	135	144020104	109	151460300	246	160740403	163	166380105	272
132440058	137	144020104	236	151460409	246	160740502	163	166480103	272
132440074	137	144030103	102	151460508	246	160740601	163	166580100	262
132440082	137	144030103	185	151470101	169	160740700	163	166720102	159
132440108	137	144040102	108	151470200	169	160740809	163	166720102	99
132440157	137	144050101	236	151480100	171	160740908	163	166730101	167
132440207	137	144050101	202	151520103	261	160741005	163	166730101	101
132440306	137	144060100	62	151520202	261	160741104	163	166810101	116
132440405	137	144070109	53	151520301	261	160741203	163	166820100	54
132440504	137	144080108	244	151520400	261	160741302	163	166980102	173
132440603	137	144080207	244	151540101	228	160741401	163	166980201	173
132440652	137	144080306	244	151540200	228	160741500	163	166980300	173
132440702	137	144080405	244	151540309	228	160741609	163	166980409	173
132440801	137	144100104	1056	151540408	228	160741708	163	166980508	173
132450057	137	14411003	271	151575145	1042	160741807	163	166980607	173
132450073	137	144110103	166	151590106	156	160741906	163	166980706	173
132450081	137	144110202	166	151590205	156	160750105	163	166980805	173
132450107	137	144110301	166	151590304	156	160750204	163	166980904	173
132450156	137	144110400	166	151590403	156	160750303	163	166981001	173
132450206	137	144110509	166	151590502	156	160750402	163	166981100	173
132450305	137	144110608	166	151590601	156	160750501	163	167150101	158
132450404	137	144110707	166	151610102	161	160750600	163	167160100	158
132450503	137	144110806	166	151610151	161	160750709	163	167170109	156
132450602	137	144110905	166	151610201	161	160750808	163	167180108	156
132450651	137	144111002	166	151610250	161	160750907	163	167200104	144
132450701	137	144120102	166	151610300	161	160751004	163	167210103	145
132450800	137	144130101	166	151610409	161	160751103	163	167220102	148
132460106	133	144140100	237	151620101	1084	160751202	163	167230101	148
132460106	106	144290103	69	151640109	160	160751301	163	167240100	146
132470105	132	144300100	96	151650108	163	160751400	163	167240209	146
132470105	106	144310109	176	151810108	168	160751509	163	167260108	143
132680109	276	144330109	305	151810207	168	160751608	163	167280106	144
139490106	286	144340106	96	151810306	168	160751707	163	167290105	143
139610109	54	144370103	250	151810405	168	160770301	62	167310101	144
143790103	54	144370103	109	151810504	168	160940102	135	167330109	142
143810109	121	144440104	69	152380101	285	161610100	171	167340108	142
143811008	121	144550100	288	152800108	122	161630108	56	167350107	142
143820108	121	144550209	288	153180104	291	161640107	56	167360106	185
143821007	121	144740107	218	153190103	291	161670104	111	167370105	149
143830107	120	144830106	260	153190202	291	161680103	111	167380104	149
143840106	132	144840105	261	153200100	275	161690102	113	167440106	58
143840106	106	144850104	263	153210109	291	161700109	113	167490200	126
143870012	194	144860103	282	153210208	292	161720107	114	167490309	126
143870020	194	144870102	282	153210307	292	161730106	112	167500206	116
143870038	194	144880101	280	153220108	281	161740105	113	167500206	275
143870046	194	144890100	289	153230107	297	161750104	113	167510106	150
143870053	194	144890209	289	154910103	156	161760103	114	167520105	150

NUMERIEKE INDEX

Order nr.	Pag.	Order nr.	Pag.	Order nr.	Pag.	Order nr.	Pag.	Order nr.	Pag.
167560101	257	173150202	53	174510107	177	177780400	182	177960309	200
167580109	147	173150301	53	174520106	117	177780459	179	178020103	149
167600105	123	173201012	290	174520106	183	177780467	179	178180105	167
167600204	123	17320409	290	174520205	117	177780475	179	178180204	167
167770106	265	17320607	290	174520205	177	177780483	179	178180303	167
167790104	266	17320805	290	174570101	147	177780491	179	178180402	167
167800200	266	17321209	290	174580100	147	177780509	179	178180501	167
167810100	267	17321258	290	174610204	249	177780608	179	178200101	176
167910108	305	17321308	290	174610204	61	177780707	179	178200200	176
167920107	142	17321605	290	174650101	124	177780806	182	178200309	183
167930106	144	17321803	290	174651000	124	177780905	179	178210100	177
168840106	107	17322009	290	174660100	59	177781002	179	178210209	177
168840106	558	173220104	233	174660209	59	177790102	180	178390100	201
168860104	558	173220203	233	174670109	59	177790201	180	178610051	254
168870103	558	173220302	233	174680108	59	177790300	180	178610101	254
168880102	557	17322405	290	174690107	59	177790409	180	178610200	254
168890101	557	17322454	290	177660107	170	177790508	180	178620100	255
168900108	299	173230103	247	177660206	170	177790607	180	178620209	256
168900207	299	173240102	235	177660305	170	177790706	180	178630109	255
17100108	266	173240201	235	177660404	170	177790805	180	178640108	255
172260101	228	173240300	235	177660503	170	177790904	180	178650206	255
172270100	246	173250101	235	177660602	170	177791001	180	178660106	256
172280109	181	173251006	235	177660701	170	177791102	180	178670105	257
172300105	192	173260100	295	177660800	170	177791209	180	178680104	257
172310104	305	17330101	290	177660909	170	177800109	180	178690103	257
172310203	305	17330200	290	177710100	233	177800208	180	178700100	204
172310302	305	17330309	290	177710209	233	177800307	180	178710109	103
172320103	114	17330408	290	177710308	233	177800406	180	178710109	183
172390106	184	17330507	290	177710407	233	177800505	180	178760104	218
172470106	146	17330606	290	177711009	233	177800604	180	178760203	218
172470205	143	17330705	290	177711108	233	177800703	180	178760302	218
172470304	145	17330804	290	177711207	233	177810108	180	178760401	218
172470403	110	17330903	290	177711306	233	177810207	180	178760500	218
172470403	247	173360108	145	177760105	179	177810306	180	178761003	218
172510109	138	173410101	235	177760204	179	177820107	180	178770103	219
172510109	247	173410200	235	177760303	179	177820206	180	178770202	219
172510208	138	173410309	235	177760402	179	177820305	180	178770301	219
172510208	247	173410408	235	177760501	179	177820404	180	178770400	219
172510307	247	173420209	541	177760600	179	177820503	180	178770509	219
172510307	138	173480107	268	177760709	179	177820602	180	178780102	219
172510406	138	17350109	290	177760808	179	177820701	180	178780201	219
172510406	247	17350208	290	177760907	179	177830106	180	178780300	219
172830101	173	17350307	290	177761004	179	177830205	180	178780409	219
172830200	173	17350406	290	177761103	179	177830304	180	178780607	219
172830309	173	17350505	290	177761152	179	177840105	180	178790051	128
172830408	173	17350604	290	177761202	179	177840204	180	178790101	128
172830507	173	17350703	290	177761301	179	177840303	180	178790309	128
172830606	173	17350802	290	177761400	179	177840402	181	178790507	128
172830705	173	17350901	290	177761509	179	177840501	181	178790606	128
172830804	173	173790106	85	177761558	179	177870102	183	178790705	128
172830903	173	174230102	288	177761608	179	177870201	183	178790804	128
172831000	173	174240101	274	177761657	179	177870300	183	178790903	128
172831109	173	174240200	274	177761707	179	177870409	183	178791000	128
172840100	138	174250209	262	177761756	179	177870508	183	178791109	98
172840209	138	174250209	295	177761806	179	177880101	183	178801007	124
172840308	138	174260109	295	177761905	179	177880200	183	178801007	98
172840407	138	174260109	263	177762002	179	177880309	183	178810107	115
172840506	138	174270108	265	177762101	179	177880408	183	178830105	116
172840605	138	174270207	265	177762200	179	177890100	184	178840104	112
172840704	138	174270207	266	177762259	179	177890209	184	178850103	111
172840803	138	174270306	265	177762309	179	177890308	184	178860102	116
172840902	138	174270306	266	177762408	179	177890407	184	178870101	114
172841009	138	174270405	266	177770104	179	177910205	237	181120106	257
172841108	138	174270405	265	177770203	179	177910304	237	185800109	97
172841207	138	174280107	254	177770302	182	177910403	237	185810108	163
172841304	138	174350108	104	177770401	179	177910502	237	185810207	163
172841306	138	174360107	104	177770500	179	177910601	237	185820107	160
172841403	138	174360107	200	177770609	182	177920105	237	185820206	160
172841405	138	174370106	102	177770708	179	177920204	237	185830106	156
172841502	138	174370106	177	177770757	179	177920303	237	185830205	156
172841601	138	174380105	102	177770807	179	177920402	237	185830304	156
172841700	138	174380105	178	177770831	179	177930104	237	185840105	156
172850109	267	174390104	183	177770856	179	177930203	237	185860103	156
172850208	267	174390104	103	177770906	179	177930302	237	185870102	160
173030107	247	174400101	102	177770955	179	177930401	237	185870102	99
173040106	234	174400101	178	177771003	179	177940103	200	185880101	176
173040205	233	174410100	103	177771102	179	177940202	200	185890100	176
173041005	234	174410100	178	177771201	179	177940301	200	185900107	176
173070103	234	174480103	109	177771300	179	177950052	203	185910106	176
173070202	234	174480103	233	177771409	179	177950102	203	185920105	182
173070301	234	174490102	103	177771508	179	177950201	203	185930104	200
173070400	234	174490102	178	177780103	179	177950300	203	185930203	200
173071002	234	174500108	178	177780202	179	177960101	200	185970100	177
173150103	53	174500108	103	177780301	179	177960200	200	185990108	146

Order nr.	Pag.	Order nr.	Pag.	Order nr.	Pag.	Order nr.	Pag.	Order nr.	Pag.
1861100103	149	186360202	226	20090205	232	207887993	346	207905431	355
186110102	143	186370102	132	20090304	232	207888009	346	207905449	355
1861140109	120	186380101	196	205630106	170	207888017	346	207907320	353
1861420208	120	186400107	234	205710106	582	207888025	346	207907338	353
186140307	120	186430104	158	205930100	688	207888033	346	207907346	353
186160107	116	186540209	197	205930308	688	207888041	346	207907353	353
186200101	115	186540308	197	205930407	688	207888082	346	207907361	353
186220109	161	186540407	197	205930506	688	207888090	346	207907379	353
186230108	204	186540506	197	205940208	689	207888108	346	207907387	353
186230207	204	186550109	182	205940307	689	207888116	346	207907403	361
186240107	211	186560108	182	205960107	689	207888124	346	207907411	361
186250106	61	186590105	184	205960305	689	207888132	346	207909268	353
186260105	195	186590204	184	205960404	689	207891409	347	207909276	353
186260204	195	186590303	184	205960503	689	207891417	347	207909284	353
186260303	195	186610101	184	206030306	690	207891425	347	207909292	353
186280103	196	186640108	208	206030405	690	207891433	347	207909300	353
186280202	196	186640207	208	206030504	690	207891441	347	207909318	353
186280301	196	186640306	207	206030603	690	207891458	347	207909326	353
186300406	197	186640405	208	206040107	691	207891466	347	207912494	317
186300505	197	186650107	208	206040206	691	207891474	347	207912502	317
186300604	197	186650206	207	206040305	691	207891482	347	207913104	361
186300703	197	186650305	207	206040404	691	207891490	347	207913112	361
186300802	197	186650404	207	206060105	690	207891508	347	207913120	361
186300901	197	186650503	207	206060204	690	207891516	347	207913138	361
186301008	197	186650602	207	206060303	690	207891524	347	207913146	361
186301107	197	186660106	251	206090052	692	207891532	347	207913153	361
186301206	197	186670105	211	206090102	692	207891540	347	207913161	361
186301305	197	186680104	211	206090201	692	207891557	347	207913203	360
186301404	197	186710109	236	206090300	692	207891565	347	207913211	360
186301503	197	186710208	236	206140105	691	207891573	347	207913229	360
186301602	197	186710307	236	206140196	691	207892225	347	207913237	360
186301701	197	186720109	134	206140204	691	207892233	347	207913245	360
186301800	197	186730107	131	206150203	692	207892241	347	207913252	360
186301909	197	186730206	131	206150302	692	207892258	347	207913260	360
186302006	197	186730305	131	206150401	692	207892266	347	207913302	361
186302105	197	186740106	100	206190100	691	207892274	347	207913310	361
186302204	197	186740106	158	206190209	691	207892282	347	207913328	361
186302303	197	186770103	235	206240103	689	207892290	347	207913336	361
186302402	197	186770103	208	206240202	689	207892308	347	207913344	361
186302501	197	186780102	100	207360504	555	207902669	362	207913351	361
186302600	197	186780102	162	207360603	555	207903733	358	207913369	361
186302709	197	186790101	162	207360702	555	207903741	358	207913443	360
186302808	197	186790208	162	207370107	555	207903758	358	207913450	360
186302907	197	186790309	162	207390105	555	207903766	358	207913468	360
186303004	197	186790408	162	207400102	554	207903774	358	207913476	360
186303103	197	186790507	162	207400201	554	207903832	358	207913484	360
186303202	197	186790606	162	207701798	346	207903840	358	207913492	360
186303301	197	186790705	162	207701806	346	207903857	358	207913500	360
186303400	197	186810107	122	207701814	346	207903865	358	207913641	358
186303509	197	186820106	211	207701822	346	207903873	358	207913658	358
186303608	197	186870101	249	207701830	346	207903881	358	207914680	357
186310405	196	186870101	60	207701848	346	207904970	359	207914698	357
186310504	196	186880100	233	207701855	346	207904988	359	207914706	357
186310603	196	186890109	233	207701863	346	207904996	359	207914714	357
186310702	196	186890208	233	207701871	346	207905001	359	207914722	357
186310801	196	186900106	120	207701913	346	207905019	359	207914730	357
186310900	196	186900205	120	207701921	346	207905027	359	207914748	357
186311007	196	186901005	142	207701939	346	207905035	359	207914789	360
186311106	196	186901104	146	207701947	346	207905050	359	207914797	360
186311205	196	186910105	232	207701954	346	207905068	359	207914805	360
186311304	196	186910204	232	207701962	346	207905076	359	207914813	360
186311403	196	190110106	266	207881038	351	207905084	359	207914821	360
186311502	196	190120105	265	207881046	351	207905092	359	207914839	360
186311601	196	190140103	288	207881053	351	207905100	359	207914847	360
186311700	196	190140202	288	207881061	351	207905118	359	207914888	360
186311809	196	190140301	288	207881079	351	207905134	359	207914896	360
186311908	196	190150409	298	207881178	351	207905142	359	207914904	360
186312005	196	190170409	292	207886847	346	207905159	359	207914912	360
186312104	196	190180109	281	207886854	346	207905167	359	207914920	360
186312203	196	190200105	260	207886862	346	207905175	359	207914938	360
186312302	196	190370106	292	207886870	346	207905183	359	207914946	360
186312401	196	190380105	292	207886888	346	207905191	359	207914987	360
186312500	196	19070101	152	207886896	346	207905217	359	207914995	360
186312609	196	198620106	291	207886904	346	207905225	359	207915000	360
186312708	196	198640104	256	207886912	346	207905233	359	207915018	360
186312807	196	198650103	280	207886920	346	207905241	359	207915026	360
186312906	196	198660102	282	207886961	346	207905258	359	207915034	360
186313003	196	198660102	292	207886979	346	207905266	359	207915042	360
186313102	196	200820207	1026	207886987	346	207905274	359	207915687	355
186313300	196	200830404	1026	207886995	346	207905381	355	207915695	355
186313409	196	200830503	1026	207887621	362	207905399	355	207915703	355
186313508	196	200850600	1026	207887969	346	207905407	355	207915711	355
186313607	196	200850600	849	207887977	346	207905415	355	207915729	355
186360103	226	20090106	232	207887985	346	207905423	355	207915802	359

NUMERIEKE INDEX

Order nr.	Pag.	Order nr.	Pag.	Order nr.	Pag.	Order nr.	Pag.	Order nr.	Pag.
207915810	359	223535709	339	23045015	287	24449040	284	25381104	296
207915828	359	223535733	339	23050057	287	24449050	284	25389010	296
207915836	359	223535741	339	23050206	287	24449060	284	25389020	296
207915844	359	223535758	339	23050404	287	24450405	284	25389030	296
207915851	359	223535766	339	23050503	287	24450504	284	25389040	296
207915869	359	223535790	339	23051020	287	24450702	284	25389050	296
207916008	359	223535808	339	23051030	287	24459010	284	25389060	296
207916016	359	223535816	339	23051050	287	24459020	284	25410200	261
207916024	359	223535824	339	23051220	287	24459030	284	25410309	261
207916032	359	223536319	337	23051230	287	24459040	284	25410408	261
207916040	359	223536327	337	23051520	287	24459050	284	25419010	261
207916057	359	223536335	337	23051530	287	24690109	272	25419020	261
207916065	359	223537705	336	23052006	287	24741001	267	25419600	261
207916305	359	223537788	336	23052020	287	24750110	267	25419800	261
207916313	359	223538380	337	23052030	287	24820201	268	25420209	297
207916321	359	223539735	336	23052508	287	24821001	268	25429100	297
207916339	359	223540584	330	23053010	287	24850109	268	25429150	297
207916347	359	223540592	330	23053015	287	24850208	268	25429250	297
207918178	357	223540758	336	23053020	287	25020108	294	25429300	297
207918186	357	223541467	335	23054010	287	25020207	294	25449010	296
207918194	357	223541475	335	23054012	287	25020405	294	25449020	296
207918202	357	223541483	335	23054015	287	25020603	294	25450100	296
207918210	357	223541491	335	23055020	287	25050204	270	25450125	296
207918228	357	223542663	330	23055025	287	25050501	270	25455000	296
207918236	357	223559972	331	23056015	287	25050600	270	25456000	296
207918277	357	223600065	332	23056020	287	25050709	270	25457500	296
207918285	357	223600446	333	23056030	287	25059000	270	25480104	262
207918293	357	223600867	330	23058020	287	25059011	270	25480203	262
207918301	357	223600875	330	23058030	287	25059012	270	25480302	262
207918319	357	223600883	330	23058040	287	25059013	270	25480401	262
207918327	357	223600891	330	23630106	272	25059015	270	25489010	262
207918335	357	223602327	338	23630205	272	25060104	270	25489020	262
208260109	552	223602335	338	23630304	272	25060302	270	25490103	262
208570101	209	223602343	338	23790108	284	25060500	270	25500109	262
208570200	209	223602350	338	23790207	284	25060609	270	25500208	262
208570309	209	223602368	338	23799010	284	25060807	270	25500406	262
208570408	209	223602392	338	23940109	286	25069010	270	25650102	258
212140107	228	223602400	338	23949900	286	25069020	270	25670100	125
212140206	228	223602418	338	24130205	283	25069030	270	25670159	125
212240105	227	223602426	338	24130304	283	25069040	270	25670209	125
212240204	227	223602434	338	24200107	283	25070103	270	25670258	125
21460605	259	223602467	338	24200206	283	25070202	270	25670308	125
21461108	264	223602475	338	24200305	283	25070301	270	25670407	125
21461207	264	223602483	338	24280109	283	25070400	270	25670506	125
21461306	264	223602491	338	24280208	283	25070509	270	25670605	125
21461405	264	223602509	338	24290207	283	25070608	270	25670704	125
21469300	259	223603176	335	24290405	283	25070707	270	25670803	125
223500240	335	223603184	334	24290702	283	25071507	270	25670902	125
223500265	335	223603192	335	24290801	283	25071606	270	25671009	125
223501776	337	223603390	334	24291007	283	25071705	270	25690108	268
223510215	330	223603465	334	24299010	283	25071804	270	25730102	129
223510223	330	223604091	338	24299020	283	25071903	270	25730201	129
223510231	330	223604133	339	24299030	283	25072000	270	25730300	129
223510249	330	223604141	339	24360208	283	25072109	270	25730409	129
223520925	331	223701632	337	24390502	284	25301706	298	25730508	129
223520933	331	224900566	264	24390700	284	25319100	297	25730607	129
223520941	331	224901066	264	24391005	284	25319125	297	25730706	129
223521030	331	224902055	264	24391104	284	25319150	297	25730805	129
223530734	332	224903044	264	24399010	284	25319200	297	25730904	129
223530742	332	224904033	264	24399020	284	25319250	297	25731001	129
223530858	330	225501077	259	24399030	284	25319300	297	25731100	129
223530866	330	225901033	257	24399040	284	25331505	296	25731209	129
223530874	330	225902000	257	24400509	284	25331604	296	25731308	129
223530882	330	225903000	257	24400707	284	25331703	296	25731407	129
223530890	330	225904000	257	24409010	284	25331802	296	25731506	129
223531906	333	225905000	257	24409020	284	25331901	296	25731605	129
223532144	338	227201066	260	24409030	284	25332008	296	25731704	129
223532193	332	227202055	260	24409040	284	25339250	296	25731803	129
223533456	333	228901077	289	24409050	284	25339500	296	25732009	129
223533696	332	228901566	289	24430407	284	25341000	296	25732108	129
223533704	332	228901722	289	24430506	284	25341500	296	25732207	129
223533712	332	228902066	289	24430704	284	25342000	296	25732306	129
223533720	332	228990000	289	24439005	284	25342007	296	25732405	129
223533977	333	228991500	289	24439010	284	25342106	296	25732504	129
223534066	333	229401000	260	24439020	284	25342205	296	25732603	129
223534462	335	230401088	287	24439030	284	25342304	296	25732702	129
223534470	335	230402077	287	24439040	284	25342500	296	25751009	261
223534488	335	230403066	287	24440208	284	25343000	296	25751108	261
223534496	335	230404055	287	24440406	284	25344000	296	25771007	261
223535261	335	230410122	287	24440505	284	25380304	296	25801002	271
223535576	331	230410155	287	24441206	284	25380502	296	25801101	271
223535675	339	230415200	287	24449010	284	25380700	296	25801200	271
223535683	339	230420200	287	24449020	284	25380809	296	25801309	271
223535691	339	230450099	287	24449030	284	25381005	296	25801408	271

Order nr.	Pag.	Order nr.	Pag.	Order nr.	Pag.	Order nr.	Pag.	Order nr.	Pag.
25841008	271	27020106	269	35650308	123	380670091	311	53181004	274
25841107	271	27020205	269	35650407	122	380670141	311	53181103	274
25841206	271	27020304	269	35650407	123	380682005	319	53181202	274
25861006	292	27020403	269	35680107	250	380682013	319	53181301	274
25900309	293	27020502	269	35810100	123	380682021	319	53360103	266
25950601	293	27020601	269	35810209	123	380682039	319	53360202	266
25951104	293	27030055	269	35860055	127	380682047	319	53370102	266
25952100	293	27030105	269	35860105	127	380682054	319	53380101	267
25952102	293	27030204	269	35860154	127	380682062	318	53700100	294
25952201	293	27030303	269	35860204	127	380682070	319	58050303	156
25953001	293	27050608	269	35860253	127	380682088	319	58050303	99
25953100	293	27100106	272	35860303	127	380682096	318	58340209	210
25953209	293	27100155	272	35860402	127	380682104	319	58340308	210
25953308	293	27100171	272	35860451	127	380682112	319	58890104	290
25953407	293	27100205	272	35860477	127	380682120	318	58890203	290
25953506	293	27100254	272	35860493	127	380682138	319	58890302	290
25953605	293	27100304	272	35860501	127	380686006	320	60060100	285
25959014	293	27109010	270	35860550	127	380686014	320	60190600	272
25959015	293	27109011	270	35860600	127	380686022	320	60191004	272
25971003	293	27109012	270	35860709	127	380686030	320	60600103	251
25990102	294	27109013	270	35860808	127	380686055	320	61180207	303
25990201	294	27109014	270	35860907	127	380686063	320	61180207	185
25990300	294	27109015	270	35870104	122	380686527	320	61380101	297
25990409	294	27560101	156	35870153	122	380686535	320	61390100	297
25990508	294	27560101	99	35870179	122	380686543	320	61931002	279
25990607	294	27560200	157	35870203	122	38190054	153	61931101	279
25990706	294	27970102	298	35870302	122	38190104	153	61931200	279
25990805	294	27970300	298	35880205	53	388200990	318	61931309	279
25990904	294	27970409	298	36200103	131	388231003	318	61931408	279
25991308	294	27970557	298	36200202	131	39180104	96	62460100	62
25991506	294	27970607	298	36200301	131	39180203	96	62571005	125
25991605	294	27970615	298	36200400	131	39820055	124	62571104	125
25991704	294	27970623	298	36200509	131	39820105	124	62571203	125
25991902	294	27970706	298	36200608	131	39820121	124	62571302	125
25992009	294	27970805	298	36200707	131	39820154	124	62571401	125
25992108	294	28000107	298	36200806	131	39820200	124	62571500	125
25992207	294	28000305	298	36200905	131	39820303	124	63090104	228
25992405	294	28000404	298	36201002	131	43970201	274	63090203	228
25992504	294	28130102	152	36201101	131	44280105	104	642502058	339
25992702	294	28130201	152	36201200	131	44280105	200	642502066	339
25992801	294	28930105	62	36201309	131	51750107	290	642502074	339
25992900	294	28930154	62	36201408	131	51750206	290	642502082	339
26000109	294	28930107	62	36513109	229	51750305	290	642502090	339
26210054	126	28930204	62	36513208	229	51750404	290	65610206	263
26210104	126	28930303	62	36513307	229	51750503	290	65610404	263
26210203	126	28930402	62	37300100	249	51750602	290	65611006	263
26210302	126	294500012	350	37300209	249	51750701	290	65611105	263
26210401	126	294500020	350	380600219	312	51760106	290	67920306	293
26210500	126	294500038	350	380600221	312	51760205	290	67921007	293
26210609	126	294500046	350	380600304	310	51760304	290	67921106	293
26210708	126	29960101	123	380600312	310	51760403	290	67921205	293
26210807	126	320000052	334	380600320	310	51760502	290	68180108	303
26210906	126	34860106	124	380600338	310	51760601	290	68180108	185
26211003	126	34860205	124	380600403	313	51760700	290	68200104	129
26211102	126	34960054	206	380600445	312	52090107	270	68200203	129
26211201	126	34960104	206	380600452	310	52090206	270	68200302	129
26211300	126	34960153	206	380600460	310	52090305	270	68200401	129
26211409	126	34960179	206	380600478	310	52090404	270	68200500	129
26211508	126	34960203	206	380600486	310	52171402	297	68200609	129
26243006	278	34960302	206	380600502	310	52380102	267	68200708	129
26243105	278	35020056	206	380600510	310	52430105	267	68200807	129
26243204	278	35020106	206	380600551	310	52520202	294	68200906	129
26243303	278	35020155	206	380600569	310	52520301	294	68250109	130
26243402	278	35020171	206	380600577	310	52520400	294	68250208	130
26243501	278	35020205	206	380600767	313	52530102	267	68250307	130
26243600	278	35020304	206	380600775	313	52530201	267	68250406	130
26243709	278	35620038	125	380600783	313	52539010	267	68250505	130
26390203	271	35620061	125	380600791	313	52700309	285	68250604	130
26410209	271	35620095	125	380600809	313	52709200	285	68250703	130
26430108	258	35620103	125	380600882	312	52709300	285	68250802	130
26430207	258	35620202	125	380600916	312	52720109	258	68250901	130
26430405	258	35620301	125	380600924	312	52720208	258	68260058	125
26430504	258	35620350	125	380600932	312	52720307	258	68260108	125
26450106	259	35620400	125	380600940	313	52720406	258	68260207	125
26450205	259	35620459	125	380601005	313	52910106	276	68260306	125
26460105	268	35620509	125	380601013	313	52910205	276	68280106	125
26510107	259	35620608	125	380605097	310	52910304	276	68280205	125
26510131	259	35630102	123	380605105	311	52910403	276	68280304	125
26510164	259	35640101	123	380605154	311	52910502	276	68350107	126
26510206	259	35640200	123	380605204	311	52910601	276	68350206	126
26510305	259	35640309	123	380605253	311	52910700	276	68350305	126
26510404	259	35650050	123	380605200	311	53070108	264	68610104	96
26540203	285	35650100	123	380670018	311	53180204	274	68761015	287
26700302	285	35650209	123	380670026	311	53180303	274	68761020	287

NUMERIEKE INDEX

Order nr.	Pag.	Order nr.	Pag.	Order nr.	Pag.	Order nr.	Pag.	Order nr.	Pag.
68761030	287	69890309	125	705301417	162	712102170	551	712404100	553
68761220	287	69890358	125	705301517	162	712102190	551	712404150	553
68761230	287	69890408	125	705301922	162	712102200	561	712404550	554
68761520	287	69890507	125	705311112	162	712102220	561	712404850	554
68761530	287	69890606	125	705311416	162	712102230	241	712502102	583
68762006	287	69940104	61	709000029	225	712102250	553	712502104	583
68762020	287	69940203	61	709000032	225	712102270	553	712502132	583
68762508	287	69940252	61	709000044	164	712102300	552	712506450	582
68763009	287	69940278	61	710000003	1052	712102301	552	713000008	1043
68763010	287	69940302	61	711600305	316	712102302	552	713000010	1043
68763015	287	69940401	61	711600800	316	712102304	552	713000012	1043
68763020	287	69940500	61	711600805	316	712102600	552	713000015	1043
68764010	287	69940609	61	711654001	314	712102601	552	713000020	1043
68764012	287	69940708	61	711654005	314	712102605	552	713000075	1043
68764015	287	69950103	126	711660118	316	712102700	553	713000100	1043
68764020	287	69950202	126	711662001	316	712102900	552	713000125	1043
68765015	287	69950301	126	711662003	316	712103010	552	713000150	1043
68765020	287	69950400	126	711662005	316	712105200	407	713000210	1044
68765025	287	69950509	126	711662007	316	712105420	550	713000214	1044
68766015	287	69950608	126	711662021	316	712105520	550	713000220	1044
68766020	287	69950707	126	711690100	682	712105610	550	713000230	1044
68766030	287	69950806	126	711700117	666	712105650	550	713000234	1044
68768015	287	69950905	126	711803001	560	712105601	550	713000240	1044
68768020	287	69951002	126	712000100	564	712105850	550	713000513	1042
68768030	287	69970101	127	712001210	564	712105854	550	713000518	1042
68768040	287	69970200	127	712001242	564	712105910	550	713002100	1044
68800101	106	69970309	127	712001245	564	712105950	550	713002125	1044
68800101	132	69970408	127	712002252	565	712106001	561	713003171	858
68830108	151	69970507	127	712002241	565	712112120	550	713003231	860
68830207	151	69970606	127	712003331	565	712112124	550	713003233	860
68840107	151	69970705	127	712003650	566	712112125	550	713003261	862
68850106	97	69970804	127	712005261	566	712112130	551	713003263	862
68860105	97	69970903	127	712005291	567	712112150	551	713003331	864
68870104	98	701303036	164	712005310	571	712115608	550	713003333	864
68910108	157	701303641	164	712005361	567	712200100	583	713008131	851
68910108	99	701304146	164	712005531	577	712201001	583	713008141	852
68910157	100	701304650	164	712005553	577	712201003	583	713008161	853
68910157	161	701611020	164	712007411	570	712201011	583	713008201	854
68910207	157	701611030	164	712007421	570	712201012	583	713008203	854
68910207	99	701611040	164	712007623	571	712201041	551	713008251	855
68920107	101	701611050	164	712008312	570	712201042	551	713008253	855
68920107	173	701611060	164	712009410	570	712316000	582	713008257	855
68930106	101	701611070	164	712009414	570	712316001	582	713008321	856
68930106	170	701611080	164	712009432	570	712316003	582	713008323	856
68930205	101	701611090	164	712009531	571	712316050	582	713008327	856
68930205	170	701611100	164	712009731	571	712316060	582	713008328	856
68940105	181	701611110	164	712018531	574	712316061	582	713009161	850
68940139	181	701611120	164	712018731	574	712316080	582	713009181	850
68940162	181	701611130	164	712024712	576	712316080	582	713010205	767
68940204	181	701611150	163	712024812	576	712316200	582	713010255	767
68940303	181	701611170	163	712025117	577	712316201	582	713011233	866
68940402	181	701611180	164	712025813	577	712316260	582	713011263	866
68940501	181	701611190	164	712025815	577	712316261	582	713011333	866
68940600	181	701611200	164	712028752	576	712316270	582	713012275	802
68940709	181	701611210	164	712028753	576	712316280	582	713020217	868
69060101	305	701611220	164	712049049	583	712401100	555	713020218	868
69070100	214	701611230	164	712049053	583	712401220	555	713020241	870
69110104	224	703311117	156	712059080	582	712401260	556	713020243	870
69150100	245	703311120	156	712070601	579	712401300	556	713020245	870
69190106	1057	703311500	157	712070801	579	712401310	556	713020281	872
69190106	108	703312000	157	712101050	559	712401400	556	713020283	872
69210102	110	704302528	161	712101052	559	712401420	556	713020285	872
69220101	110	704303236	161	712101260	559	712401440	556	713020333	874
69340107	108	704303641	161	712101261	559	712401450	556	713020335	874
69340107	246	704304146	161	712101265	559	712401500	557	713020420	876
69360105	232	704304650	161	712101267	559	712401520	557	713020430	876
69360204	232	704311112	161	712101400	559	712402101	559	713020440	876
69509010	285	704311214	161	712101401	560	712402200	558	713021303	878
69790103	124	704311415	161	712101412	560	712402219	559	713034220	886
69790202	124	704311416	161	712101415	560	712402227	559	713034230	888
69790301	124	704311517	161	712101420	560	712402239	559	713034240	890
69800100	125	704311920	161	712101425	560	712402243	559	713034260	882
69800209	125	704312108	160	712101600	560	712402300	559	713034270	884
69800308	125	704312112	160	712101601	560	712402381	559	713034303	880
69800407	125	704312122	161	712101614	560	712402382	559	713034335	892
69800506	125	704312325	161	712101617	560	712402383	559	713034340	894
69800605	125	704312631	161	712101620	560	712402384	559	713034345	896
69800704	125	704312833	161	712101622	560	712403190	554	713034508	902
69800803	125	704313033	161	712101910	582	712403200	554	713041030	904
69800902	125	704316080	161	712102008	551	712403450	561	713041060	906
69890101	125	704319011	161	712102100	550	712403470	553	713041070	908
69890150	125	705301113	162	712102110	550	712403500	561	713041090	910
69890200	125	705301315	162	712102124	551	712403520	561	713050571	1026
69890259	125	705301317	162	712102125	551	712403700	561	713050572	1026

Order nr.	Pag.	Order nr.	Pag.	Order nr.	Pag.	Order nr.	Pag.	Order nr.	Pag.
713050573	1026	713107175	1105	713350220	1061	713354170	1047	713357682	1105
713050574	1026	713107175	773	713350221	1061	713354175	1047	713357684	1105
713050585	1026	713107180	1105	713350456	1028	713354178	1047	713357686	1105
713050608	1026	713107180	773	713351010	1052	713354200	1045	713357688	1105
713050610	1026	713107185	773	713351021	1053	713354202	1045	713357751	1095
713050623	1026	713107185	1105	713351027	1053	713354217	1045	713357752	1095
713050626	1026	713107200	1105	713351106	1095	713354220	1045	713357753	1095
713050630	1026	713107200	773	713351109	1095	713354225	1045	713357754	1095
713050636	1026	713107205	1105	713351110	1095	713355100	1046	713357801	1108
713050637	1026	713107205	773	713351114	1095	713355102	1046	713357832	1108
713050656	1026	713107210	1105	713351131	1052	713355127	1046	713357834	1108
713050657	1026	713107210	773	713351152	1052	713355129	1046	713357836	1108
713050658	1027	713107215	1105	713351160	1053	713355150	1046	713357838	1108
713050659	1027	713107215	773	713351170	275	713355152	1046	713357854	1108
713050660	1027	713107250	773	713351490	788	713355200	1046	713357856	1108
713050661	1027	713107250	1105	713351509	1095	713355500	1047	713357858	1108
713050663	1027	713107255	773	713351511	1095	713356100	1051	713357860	1108
713050664	1027	713107255	1105	713351512	1095	713356110	1049	713357862	1108
713050665	1027	713107270	1105	713351513	1095	713356125	1050	713357865	1108
713050667	1027	713107270	773	713351514	1095	713356150	1049	713359005	714
713050668	1027	713107275	1105	713351518	1095	713356152	1051	713381012	1032
713050669	1027	713107275	773	713351522	1029	713356154	1051	713381016	1032
713050670	1027	713107320	1106	713351980	1095	713356155	1051	713381018	1032
713050675	1027	713107320	773	713352001	1077	713356157	1051	713383881	1013
713050676	1027	713107321	773	713352002	1077	713356200	1049	713383881	842
713051002	1084	713107321	1106	713352014	1029	713356205	1051	713383882	1013
713051003	1084	713107330	1106	713352015	1048	713356225	1051	713383882	842
713051004	1085	713107330	773	713352016	1048	713356254	1051	713383883	1013
713051015	1057	713107331	1106	713352017	1048	713356365	1050	713383883	842
713051026	1085	713107331	773	713352018	1048	713356591	1042	713383884	1013
713051057	1057	713242100	722	713352019	1048	713356595	1042	713383884	842
713051063	1085	713244028	722	713352022	1031	713356596	1042	713383885	1013
713060005	1089	713244030	721	713352025	1031	713356600	1042	713383885	842
713060024	1090	713290278	802	713352029	1031	713356660	1077	713383886	1013
713060025	1090	713290290	806	713352031	1049	713356663	1077	713383886	842
713060026	1090	713290295	806	713352032	1049	713357444	1092	713383888	842
713060028	1090	713290335	808	713352035	1031	713357446	1092	713383888	1013
713060030	1090	713290350	810	713352036	1031	713357448	1092	713383921	1012
713060032	1090	713300100	788	713352042	1041	713357454	1092	713383922	1012
713060044	1090	713300122	787	713352052	1029	713357456	1092	713383924	1012
713060045	1090	713300136	794	713352053	1029	713357458	1092	713383931	1012
713060046	1090	713300150	795	713352054	1029	713357511	1095	713383941	1012
713060048	1090	713300181	796	713352055	1029	713357518	1095	713384001	1012
713060050	1090	713300182	798	713352069	1028	713357519	1095	713384108	1013
713060052	1090	713300185	796	713352070	1028	713357520	1095	713384110	1013
713060090	1090	713300186	798	713352074	1091	713357521	1095	713384112	1013
713060092	1076	713300210	800	713352083	1091	713357522	1095	713384117	1013
713100020	764	713300212	800	713352084	1091	713357524	1095	713384122	1013
713100110	763	713300275	802	713352085	1091	713357525	1095	713384127	1013
713100115	763	713300285	804	713352086	1091	713357526	1095	713384132	1013
713100121	765	713302275	784	713352102	1028	713357528	1095	713384137	1013
713100125	765	713302300	784	713352113	1060	713357529	1095	713384142	1013
713100126	1107	713310305	756	713352393	1032	713357530	1095	713384147	1013
713100127	1107	713311071	757	713352394	1032	713357531	1095	713384152	1013
713101175	767	713334400	900	713353003	936	713357532	1095	713384157	1013
713101200	767	713334403	898	713353004	931	713357538	1095	713384162	1013
713101203	767	713335040	912	713353004	936	713357540	1095	713384167	1013
713101210	769	713335050	912	713353005	933	713357541	1095	713384172	1013
713101213	769	713335060	912	713353005	935	713357542	1095	713384177	1013
713101253	767	713336005	942	713353005	936	713357543	1095	713384182	1013
713101260	769	713336028	938	713353006	936	713357550	1094	713384187	1013
713101303	767	713336048	940	713353020	1048	713357551	1094	713384192	1013
713101320	770	713336088	948	713353022	1048	713357552	1094	713384197	1013
713101323	770	713336110	944	713353024	1048	713357553	1094	713384202	1013
713101325	770	713336120	946	713353025	1048	713357609	839	713384225	1013
713101815	766	713338116	918	713353026	1048	713357610	839	713384240	1013
713101817	766	713338120	920	713353028	1048	713357611	839	713384252	1013
713101820	766	713338122	920	713354000	1048	713357612	1105	713384267	1013
713107050	772	713338130	922	713354000	258	713357613	839	713384294	1013
713107100	772	713338430	930	713354001	1048	713357614	1105	713384295	1013
713107101	772	713338431	930	713354001	258	713357616	1105	713384300	1013
713107103	772	713338440	928	713354100	1045	713357618	1105	713385100	276
713107105	1106	713338450	924	713354102	1045	713357622	1104	713386200	1060
713107106	1106	713338453	932	713354110	1046	713357624	1104	713400923	968
713107120	1107	713338456	934	713354112	1046	713357626	1104	713400926	968
713107120	764	713338460	926	713354120	1046	713357628	1104	713400928	968
713107121	1107	7133346120	950	713354122	1046	713357642	1104	713401000	972
713107121	764	7133346130	950	713354125	1045	713357644	1104	713401008	972
713107150	773	7133346140	950	713354127	1045	713357646	1104	713401158	974
713107150	1105	713350212	1061	713354130	1046	713357648	1104	713401168	978
713107155	773	713350213	1061	713354132	1046	713357672	1104	713401169	978
713107155	1105	713350214	1061	713354150	1045	713357674	1104	713402109	982
713107170	1105	713350215	1061	713354152	1045	713357676	1104	713402159	982
713107170	773	713350216	1061	713354165	1049	713357678	1104	713402209	982

NUMERIEKE INDEX

Order nr.	Pag.	Order nr.	Pag.	Order nr.	Pag.	Order nr.	Pag.	Order nr.	Pag.
713402619	986	713441211	1064	713442575	1038	713539001	275	713661224	841
713402629	986	713441261	1062	713442577	1038	713570015	1031	713661225	841
713402639	986	713441261	1063	713442622	1040	713571941	1031	713661226	841
713402720	990	713441261	1072	713442621	1040	713601751	1075	713661227	841
713402730	990	713441263	1068	713442622	1040	713601760	1075	713661228	841
713402782	992	713441263	1072	713442640	1039	713601761	1075	713661311	841
713402783	992	713441263	1065	713442641	1040	713601762	1075	713661312	841
713403110	970	713441263	1064	713442642	1040	713601763	1075	713661313	841
713403130	976	713441267	1071	713442645	1039	713612308	1094	713661314	841
713403150	980	713441267	1064	713442650	1039	713612310	1094	713661315	841
713403170	984	713441268	1064	713442651	1040	713612314	1094	713661316	841
713403210	988	713441268	1071	713442652	1040	713620251	780	713661317	841
713420260	954	713441269	1064	713442655	1039	713620253	780	713661318	841
713420310	956	713441269	1071	713442660	1039	713620275	780	713661321	841
713420320	958	713441270	1064	713442661	1040	713620303	781	713661322	841
713420325	958	713441270	1071	713442662	1040	713621315	782	713661323	841
713420330	960	713441305	1032	713442665	1039	713621350	783	713661324	841
713420333	960	713441306	1032	713442666	1040	713625400	785	713661325	841
713420335	960	713441310	1033	713442675	1039	713625401	785	713661326	841
713420355	962	713441312	1037	713442710	1037	713625402	785	713661327	841
713425001	964	713441313	1037	713442712	1037	713630105	789	713661328	841
713425003	964	713441315	1033	713442716	1037	713630125	790	713661512	841
713425006	964	713441410	1033	713442720	1037	713630150	791	713661513	841
713427001	966	713441413	1037	713442725	1037	713630152	792	713661514	841
713427003	966	713441415	1033	713442731	1037	713642571	780	713661515	841
713427006	966	713441503	1034	713442760	1038	713643171	781	713661516	841
713433340	994	713441508	1061	713442762	1038	713643171	782	713661517	841
713433350	996	713441509	1033	713442763	1038	713643171	783	713661518	841
713433360	998	713441511	1065	713442765	1038	713644071	785	713661521	841
713440210	1033	713441512	1037	713442768	1038	713650011	1095	713661522	841
713440211	1033	713441513	1037	713442808	1039	713650012	1095	713661523	841
713440230	1033	713441554	1033	713442810	1039	713650013	1095	713661524	841
713440231	1033	713441556	1033	713442812	1039	713650014	1095	713661525	841
713440281	1032	713441558	1033	713442816	1039	713650015	1095	713661526	841
713440287	1037	713441571	1071	713442820	1039	713650016	1095	713661527	841
713440305	1032	713441571	1065	713442825	1039	713650017	1095	713661528	841
713440312	1037	713441571	1066	713442831	1039	713650018	1095	713690045	812
713440360	1033	713441572	1071	713442840	1039	713650400	1092	713690054	814
713440361	1033	713441572	1066	713442844	1039	713652250	1092	713703078	760
713440409	959	713441572	1065	713442846	1039	713652253	1092	713705100	761
713440409	965	713441610	1067	713442850	1039	713652504	1092	713705120	1108
713440409	967	713441617	1067	713442854	1039	713652506	1092	713705126	1108
713440409	957	713441623	1068	713442872	1040	713653154	1092	713705132	1108
713440409	963	713441640	1069	713442874	1040	713653156	1092	713705142	1108
713440409	961	713441641	1069	713442876	1040	713653158	1092	713705148	1108
713440505	1032	713441650	1070	713442878	1040	713653504	1092	713705160	1108
713440506	1032	713441701	1068	713442880	1040	713653506	1092	713705176	1108
713440511	1037	713441703	1073	713442884	1040	713654048	1092	713721004	1104
713440680	1032	713441701	1067	713442888	1040	713654049	1092	713721006	1104
713440685	1032	713441702	1073	713442890	1040	713655005	1095	713721008	1104
713440686	1032	713441702	1067	713442892	1037	713655100	1095	713721010	1104
713440700	1034	713441703	1067	713442904	1037	713655101	1095	713722080	1105
713440732	1034	713441703	1073	713442906	1037	713655105	1095	713722101	1107
713440733	1034	713441704	1068	713442908	1037	713655115	1095	713722128	1105
713440734	1034	713441704	1073	713442910	1037	713655205	1095	713722150	1108
713440912	1091	713441705	1068	713442912	1037	713660700	838	713722612	1104
713441003	1034	713441705	1073	713442916	1037	713660705	838	713722640	1104
713441008	1061	713441808	1061	713442920	1039	713661111	841	713722660	1104
713441011	1062	713442020	1037	713442922	1039	713661112	841	713722712	1104
713441108	1061	713442025	1037	713442924	1039	713661113	841	713722740	1104
713441109	1029	713442040	1038	713442926	1039	713661114	841	713722760	1104
713441111	1063	713442045	1038	713442928	1039	713661115	841	713723090	1107
713441122	1029	713442050	1038	713442930	1039	713661116	841	713723091	1107
713441161	1064	713442055	1038	713442932	1039	713661117	841	713723092	1107
713441161	1065	713442065	1038	713444003	1034	713661118	841	713723093	1107
713441161	1072	713442120	1038	713444011	1066	713661121	841	713723094	1107
713441162	1062	713442125	1038	713444012	1037	713661122	841	713723095	1107
713441162	1063	713442140	1039	713444013	1037	713661123	841	713723096	1107
713441162	1064	713442145	1039	713444041	1037	713661124	841	713726040	1104
713441162	1072	713442150	1039	713444071	1072	713661125	841	713726060	1104
713441163	1069	713442155	1039	713444072	1072	713661126	841	713726080	1104
713441163	1070	713442165	1039	713444073	1066	713661127	841	713726120	1104
713441164	1063	713442520	1037	713444073	1070	713661128	841	713770102	725
713441164	1065	713442522	1038	713444074	1066	713661211	841	713770125	725
713441164	1069	713442540	1038	713444074	1072	713661212	841	713770126	726
713441164	1071	713442542	1038	713444075	1066	713661213	841	713770127	725
713441164	1062	713442545	1038	713444075	1071	713661214	841	713770512	738
713441165	1062	713442550	1038	713444076	1066	713661215	841	713770610	723
713441165	1063	713442552	1038	713444076	1070	713661216	841	713771050	723
713441165	1070	713442555	1038	713500123	1000	713661217	841	713776030	718
713441166	1062	713442560	1038	713500430	1002	713661218	841	713776102	719
713441166	1072	713442562	1038	713501080	1004	713661221	841	713776103	719
713441166	1069	713442565	1038	713501105	1006	713661222	841	713776111	711
713441166	1063	713442567	1038	713511210	1008	713661223	841	713776165	711

Order nr.	Pag.	Order nr.	Pag.	Order nr.	Pag.	Order nr.	Pag.	Order nr.	Pag.
713777010	721	713921221	758	715165310	599	715911206	587	716190100	370
713779200	724	713921226	758	715165311	599	715911208	587	716190250	370
713780011	728	713922000	774	715165315	599	715912100	587	716190900	386
713780618	734	713922002	774	715165316	599	715912121	587	716191000	370
713781301	735	713922003	774	715165320	599	715912208	587	716191030	369
713790006	718	713922004	774	715165321	599	715911506	587	716191060	369
713800018	595	713922011	774	715165325	599	715911508	587	716191120	369
713800021	595	713922012	774	715165326	599	715911510	587	716192060	369
713800024	595	713922013	774	715165327	599	715911512	587	716192120	369
713800026	595	713922014	774	715166310	599	715911515	587	716195020	369
713800027	595	713922075	759	715166315	599	715911628	601	716196015	369
713800029	595	713922076	759	715166320	599	715911660	601	716196050	369
713800030	595	713940010	728	715166325	599	715911661	601	716197150	370
713800032	595	713940112	734	715166326	599	715912501	587	716201500	371
713800038	595	713940113	734	715260300	602	715912506	587	716201600	370
713812030	729	713951610	816	715260306	602	715912508	587	718011134	1089
713812035	731	715101411	623	715262518	607	715912510	587	718011135	1089
713812036	733	715101911	623	715262524	607	715912512	587	718011151	1089
713813103	736	715102019	623	715262542	607	715912515	587	718011152	1089
713813201	737	715102070	624	715262581	607	715913250	592	718011178	1090
713816001	711	715102102	625	715263128	607	715913251	606	718011179	1090
713816002	711	715102151	625	715263148	607	715913260	592	718011181	1090
713840231	778	715102152	625	715263160	607	715913311	593	718011182	1090
713849314	779	715111000	622	715326617	596	715914250	586	718011226	1089
713850010	1032	715114501	622	715333682	596	715915250	592	718011227	1089
713850011	1092	715115523	622	715336718	616	715917510	589	719000400	1034
713850231	1092	715116300	622	715382330	591	715917512	589	719000410	1013
713850232	1092	715121051	617	715382430	591	715917515	589	719000420	1012
713850233	1092	715121052	619	715701305	603	715917518	589	721391013	166
713853502	1092	715121053	619	715702305	602	715917522	589	721391719	166
713853503	1092	715121054	619	715900003	626	715917560	589	721391922	166
713853504	1092	715121501	619	715900003	838	715917580	589	721392224	166
713860300	846	715121502	619	715900004	626	715918510	589	721392430	166
713860350	845	715122005	619	715900004	838	715918512	589	721392730	166
713860351	844	715122006	619	715900005	627	715918515	589	721393236	166
713860500	847	715122007	619	715900005	838	715918518	589	721401700	166
713860502	847	715122008	619	715900006	627	715918522	589	721401900	166
713860754	848	715122009	617	715900007	626	715918560	589	721402200	166
713861204	848	715122054	619	715900008	627	715918580	589	721402400	166
713867504	849	715122055	619	715900009	626	715920450	613	721402600	166
713873008	1088	715122056	619	715900010	627	715920900	613	721402700	166
713876001	849	715122401	617	715900012	627	715921100	614	721402900	166
713876004	849	715122403	617	715900012	839	715921200	615	721403000	166
713876005	849	715122554	619	715900020	626	715931011	616	721403200	166
713880077	730	715123054	619	715900022	626	715931020	616	721403600	166
713880078	730	715123055	619	715900025	626	715931021	616	721404100	166
713880080	730	715123056	619	715900251	597	715931023	616	722011000	168
713880081	730	715123303	617	715900255	605	715931030	616	722011500	168
713880082	730	715123304	617	715900301	587	715931050	616	722012000	168
713880083	730	715124003	617	715900315	608	715931056	616	722013000	168
713880085	730	715125054	619	715900317	609	715931060	616	722161600	209
713880086	730	715125055	619	715900351	597	715931101	616	722162001	209
713880087	732	715125056	619	715900500	600	715931102	616	722163001	209
713880088	732	715125403	618	715900504	600	715960501	610	722164001	209
713880089	732	715127003	621	715900505	601	715960700	610	722165000	209
713880090	732	715127004	621	715900790	588	715960703	610	722166001	209
713880091	732	715127005	621	715900850	589	715960704	610	722174000	209
713880092	732	715135160	620	715901405	590	715960705	610	722175000	209
713880093	732	715135161	620	715902000	611	715970055	610	722176000	209
713880094	732	715135200	620	715902200	587	715970070	610	722184000	209
713880095	732	715141212	619	715902251	594	715970155	610	722184010	209
713880096	732	715153501	598	715903251	606	715970170	610	722186000	209
713880097	732	715154301	598	715903253	606	715981105	612	722186010	209
713880098	732	715154303	598	715903260	592	715981117	612	722310033	693
713880099	732	715155303	598	715903300	593	715991105	612	722310034	693
713880100	732	715155313	599	715903315	607	716150001	369	722310035	693
713880103	733	715156303	599	715903316	607	716150200	368	722310036	693
713880104	733	715162506	597	715904150	586	716150203	370	722310037	693
713880105	733	715162512	597	715904250	586	716150225	368	722310038	693
713880106	733	715163203	597	715905250	592	716150256	368	722313500	656
713880107	733	715163206	597	715905600	604	716150262	369	722313501	657
713880108	733	715163226	599	715910258	605	716151016	371	722313502	657
713880109	733	715163506	597	715910259	605	716170001	393	722313505	656
713880110	733	715163512	597	715910810	598	716170003	393	722313506	657
713880111	733	715163515	597	715910812	598	716170006	393	722313510	656
713880112	733	715163606	597	715910813	598	716170010	393	722313511	657
713880113	733	715163606	599	715910814	598	716170103	393	722314070	653
713880114	733	715163706	599	715911001	587	716170105	393	722314125	653
713880115	733	715163712	599	715911001	1108	716170110	393	722314175	653
713880116	733	715163715	599	715911006	587	716190003	370	722314215	653
713880151	730	715164310	599	715911008	587	716190008	370	722315070	654
713880152	730	715164315	599	715911010	587	716190010	370	722315125	654
713880153	732	715164320	599	715911012	587	716190020	370	722316050	655
713900030	537	715164325	599	715911015	587	716190050	370	722316053	655

NUMERIEKE INDEX

Order nr.	Pag.	Order nr.	Pag.	Order nr.	Pag.	Order nr.	Pag.	Order nr.	Pag.
722316150	655	724581120	248	727814810	216	73191702	196	742001616	1082
722316153	655	724581130	248	727815010	215	73191801	196	742002106	1082
722316200	652	724581140	248	727816400	216	73191900	196	742002108	1082
722316205	652	724581180	1106	727817010	214	73240103	278	742002110	1082
722316216	652	724581180	248	727817100	215	73250102	259	742002112	1082
722316345	650	724581190	1106	727819010	214	73530107	150	742002114	1082
722316350	650	724581190	248	727819090	215	73720500	121	742002116	1082
722316352	650	724581195	1106	727819500	215	73721003	121	742002118	1082
722316360	651	724581195	248	727819700	216	73721102	121	742060400	1081
722316365	651	724581230	248	728091085	68	73721201	121	742060500	1081
722316366	651	724581260	248	728540090	189	73721300	121	742060600	1081
722316367	651	724581270	248	728540100	189	73721409	121	742060800	1081
722410001	693	724581310	248	728541001	189	73722050	121	742060900	1081
724302020	240	724600215	240	728541017	189	73722159	121	742061000	1081
724551010	241	724603000	240	728600530	52	73722209	121	742061200	1081
724552020	242	724605000	240	728601001	52	73722308	121	742061400	1081
724555050	224	725473060	241	729202000	165	73722407	121	742061505	1081
724561001	404	725473061	241	72920309	165	737551500	550	742061506	1081
724561003	404	72570104	182	72920358	165	737553000	550	742061600	1081
724561004	403	72660103	134	72920408	165	73860108	123	742061800	1081
724561006	404	72660202	134	72920507	165	73860207	123	742062000	1081
724561008	404	72670052	157	72920606	165	73860256	123	742062008	1081
724562230	162	72670102	157	72920705	165	73860306	123	742062010	1081
724570010	243	72670201	157	72921000	165	73860355	123	742062012	1081
724570011	243	72670300	157	72921109	165	73860405	123	742064006	1081
724571010	242	72670409	157	72921208	165	73860454	123	742064008	1081
724571110	240	72670508	157	73000101	100	73860504	123	742064010	1081
724573020	242	72670607	157	73000110	165	73860553	123	742064012	1081
724573025	242	72670706	157	73090102	151	73860603	123	742069040	1084
724573035	242	72670805	157	73100109	152	73860652	123	742070100	1082
724573040	243	72670904	157	731010004	715	73860702	123	742070150	1082
724573055	243	72671001	157	731010005	715	73860801	123	742070200	1082
724573330	241	72671100	157	731010006	715	73980104	122	742070250	1082
724574040	240	72671209	157	731013000	715	73980203	122	742070300	1082
724574180	241	72671308	157	731015000	715	73980252	122	742070350	1082
724575010	240	72671407	157	731024080	715	73980302	122	742070400	1082
724575050	240	72671506	157	731035022	716	73980401	122	742070450	1082
724575180	240	72671605	157	731035026	716	73981003	122	742070500	1082
724575220	240	72671704	157	731045010	715	73981052	122	742070550	1082
724576020	429	72671803	157	731051001	715	73982001	122	742070600	1082
724576040	429	72671902	157	731051064	716	74031006	268	742070650	1082
724576050	426	72672009	157	731051066	716	74110057	123	742070700	1082
724576050	427	72672108	157	731051068	716	74110073	123	742070750	1082
724576060	240	72672207	157	731051070	716	74110107	123	742070800	1082
724576080	429	72672306	157	731051072	716	74110206	123	742070850	1082
724576085	430	72672405	157	731051074	716	74150103	206	742070900	1082
724576090	430	72672504	157	731051076	716	74160011	237	742070950	1082
724576200	427	72672603	157	731051078	716	74160029	237	742071000	1082
724576400	427	72672652	157	731051080	716	74160037	237	742071050	1082
724576405	427	72672686	157	731051082	716	74160052	236	742071100	1082
724576490	427	72672702	157	731060117	715	74160102	236	742071150	1082
724576491	426	72672751	157	731060120	715	74160201	236	742071200	1082
724576492	426	72672801	157	731060121	715	74160300	237	742071250	1082
724576493	426	72672850	157	731060122	715	74160409	237	742071300	1082
724576494	426	72672900	157	731060123	715	74170051	203	742080100	1080
724576495	426	72672926	157	731064080	715	74170101	203	742080125	1080
724576496	426	72672942	157	731065010	715	741711001	561	742080150	1080
724576497	426	72672959	157	731065016	716	741711002	561	742080175	1080
724576500	426	72672967	157	731065022	716	741761001	560	742080200	1080
724576502	428	72672983	157	731065026	716	741761714	560	742080225	1080
724576505	428	72673007	157	73120107	259	741761720	560	742080250	1080
724576506	429	72673106	157	73160103	151	741771400	560	742080275	1080
724576508	428	72673205	157	73170102	122	741772000	560	742080300	1080
724576509	428	72673304	157	73190035	194	741791800	560	742080325	1080
724576510	430	72673403	157	73190050	194	741792500	560	742080350	1080
724576512	430	72673502	157	73190076	194	741801801	560	742080375	1080
724576514	431	72673601	157	73190100	105	741802501	560	742080400	1080
724576519	426	72673700	157	73190100	192	74190026	202	742080425	1080
724576521	427	72673809	157	73190175	194	74190059	202	742080450	1080
724576522	431	72673825	157	73190191	194	74190075	202	742080475	1080
724576523	431	72673833	157	73190209	194	74190083	202	742080500	1080
724576524	431	72673841	157	73190258	194	74190109	202	742080525	1080
724576525	431	72673858	157	73190274	194	74190307	202	742080550	1080
724576526	431	742001386	157	73190282	194	742001105	1082	742080575	1080
724576527	543	72673874	157	73190308	194	742001106	1082	742080600	1080
724576528	543	72673882	157	73190407	194	742001107	1082	742080650	1080
724581040	248	72673908	157	73191009	196	742001108	1082	742080700	1080
724581050	248	72674005	157	73191108	196	742001110	1082	742080750	1080
724581060	248	72674104	157	73191207	196	742001605	1082	742080800	1080
724581070	248	72674203	157	73191256	196	742001606	1082	742080850	1080
724581080	248	72674302	157	73191306	196	742001608	1082	742080900	1080
724581090	248	72674401	157	73191405	196	742001610	1082	742080950	1080
724581100	248	72674500	157	73191504	196	742001612	1082	742081000	1080
724581110	248	727814800	216	73191603	196	742001614	1082	742081050	1080

Order nr.	Pag.	Order nr.	Pag.	Order nr.	Pag.	Order nr.	Pag.	Order nr.	Pag.
742081100	1080	742121025	1078	742121275	1078	74230178	202	744591212	1104
742081150	1080	742121026	1078	742121325	1078	74230202	202	745600812	302
742081200	1080	742121027	1078	742121375	1078	74250036	206	745601017	302
742081250	1080	742121028	1078	742121425	1078	74250044	206	745601220	302
742081300	1080	742121029	1078	742121475	1078	74250051	206	745601625	302
742090100	1080	742121030	1078	742121525	1078	74250101	206	745602032	302
742090150	1080	742121031	1078	742121575	1078	74250200	206	745602540	302
742090200	1080	742121032	1078	742121625	1078	74270059	207	745603250	302
742090250	1080	742121033	1078	742121700	1078	74270109	207	745604060	302
742090300	1080	742121034	1078	742121725	1078	74270208	207	745605070	302
742090350	1080	742121035	1078	742121775	1078	74290107	120	745651100	303
742090400	1080	742121036	1078	742121825	1079	74290206	120	745651101	303
742090450	1080	742121038	1078	742121875	1079	74290305	120	745651102	303
742090500	1080	742121039	1078	742121925	1079	74291006	121	745660103	302
742090550	1080	742121040	1078	742121975	1079	74291105	121	745660112	302
742090600	1080	742121041	1078	742122025	1079	74291204	121	745660130	302
742090650	1080	742121042	1078	742122075	1079	74310038	128	745660139	302
742090700	1080	742121043	1078	742122125	1079	74310061	128	745660148	302
742090750	1080	742121044	1078	742122175	1079	74310103	128	745660161	302
742090800	1080	742121045	1078	742122225	1079	74310202	128	745660174	302
742090850	1080	742121046	1078	742122275	1079	74310301	128	745661000	303
742090900	1080	742121047	1078	742123125	1078	74310400	128	745661001	303
742090950	1080	742121048	1078	742124041	1057	74310509	128	745661010	300
742091000	1080	742121049	1078	742124051	1058	74310608	128	745661030	303
742091100	1080	742121050	1078	7421241700	1084	74310707	128	745661430	300
742091200	1080	742121051	1078	7421241900	1083	74310806	128	745661650	300
742091300	1080	742121052	1078	7421242500	1083	74310905	128	745661720	302
742101005	1079	742121053	1078	7421242000	1078	74311002	128	745661750	300
742101010	1079	742121054	1078	7421242025	1078	74311101	128	745662325	302
742101015	1079	742121055	1078	7421243000	1078	74311200	128	745662931	302
742101020	1079	742121056	1078	7421243025	1078	74311309	128	745663639	302
742101025	1079	742121057	1078	7421243050	1078	74311408	128	745664043	302
742101026	1079	742121058	1078	7421243075	1078	74311507	128	745664447	302
742101030	1079	742121059	1078	7421244000	1078	74311556	128	745664851	302
742101033	1079	742121060	1078	742124425	1078	74311655	128	745665255	302
742101035	1079	742121061	1078	7421244500	1078	74311754	128	745665659	302
742101040	1079	742121062	1078	742124475	1078	74311804	128	745666467	302
742101041	1079	742121065	1078	7421245000	1078	74311853	128	745666873	302
742101042	1079	742121067	1078	7421245025	1078	74312109	128	745667479	302
742101045	1079	742121068	1078	7421245050	1078	74312208	128	745668085	302
74210105	200	742121069	1078	7421245075	1078	74312257	128	745669297	302
742101050	1079	742121070	1078	7421246000	1078	74312307	129	745671304	301
742101055	1079	742121071	1078	7421246500	1078	74313008	129	745671405	301
742101060	1079	742121072	1078	7421247000	1078	74313107	129	745671506	301
742101065	1079	742121073	1078	7421247075	1078	74313206	129	745671607	301
742101068	1079	742121074	1078	74212470800	1078	74313305	129	745671708	301
742101070	1079	742121075	1078	74212470850	1078	74313404	129	745671809	301
742101075	1079	742121076	1078	74212470900	1078	74313503	129	745671910	301
742101080	1079	742121077	1078	74212471000	1078	74313602	129	745672011	301
742101085	1079	742121079	1078	74212480200	1080	74313701	129	745672112	301
742101090	1079	742121080	1079	74212480250	1080	74313800	129	745672213	301
742101095	1079	742121081	1079	74212480300	1080	74313909	129	745672314	301
742101100	1079	742121082	1079	74212480325	1080	74314006	129	745672415	301
742101102	1079	742121084	1079	74212480350	1080	74314105	129	745672516	301
742101105	1079	742121085	1079	74212480375	1080	74314204	129	745672617	301
742101110	1079	742121086	1079	74212480400	1080	74314303	129	745672718	301
742101120	1079	742121087	1079	74212480425	1080	74314402	129	745672819	301
742101125	1079	742121088	1079	74212480450	1080	74314501	129	745672920	301
742101130	1079	742121089	1079	74212480475	1080	74314600	129	745673021	301
742101150	1079	742121090	1079	74212480500	1080	74314709	129	745673223	301
74210147	200	742121091	1079	74212480525	1080	74314808	129	745681304	300
74210154	200	742121092	1079	74212480550	1080	74314907	129	745681405	300
74210170	200	742121093	1079	74212480575	1080	74315003	129	745681506	300
74210196	200	742121094	1079	74212480600	1080	74315102	129	745681607	300
74210204	200	742121095	1079	74212480650	1080	74315201	129	745681708	300
742110006	1084	742121096	1079	74212480700	1080	74315508	128	745681809	300
742120019	1083	742121097	1079	74212480750	1080	74315607	128	745681910	300
742120025	1083	742121098	1079	74212480800	1080	74315706	128	745682011	300
742121005	1078	742121099	1079	74212480850	1080	74315805	128	745682112	300
742121010	1078	742121100	1079	74212480900	1080	74316001	128	745682213	300
742121011	1078	742121105	1079	74212480950	1080	74316100	128	745682314	300
742121012	1078	742121110	1079	74212481000	1080	74316209	128	745682415	300
742121013	1078	742121115	1079	74212481050	1080	74316407	128	745682516	300
742121014	1078	742121120	1079	74212481100	1080	74316506	128	745682617	300
742121015	1078	742121125	1079	74212481150	1080	74316605	128	745682718	300
742121016	1078	742121130	1079	74212481200	1080	74316704	128	745682819	300
742121017	1078	742121135	1079	74212481250	1080	74316803	128	745682920	300
742121018	1078	742121140	1079	74212481300	1080	74316902	128	745683021	300
742121019	1078	742121145	1079	742201203	1026	74317009	128	745683122	300
742121020	1078	742121150	1079	742202011	1026	74317108	128	745683223	300
742121021	1078	742121155	1079	74230038	202	74350109	232	745691001	302
742121022	1078	742121160	1079	74230053	202	74350208	232	745691102	302
742121023	1078	742121175	1078	74230103	202	744591204	1104	745691203	302
742121024	1078	742121225	1078	74230152	202	744591206	1104	745691304	302

NUMERIEKE INDEX

Order nr.	Pag.	Order nr.	Pag.	Order nr.	Pag.	Order nr.	Pag.	Order nr.	Pag.
745691405	302	745740320	302	747809320	217	748255026	1088	748260098	1093
745691506	302	745740340	302	747809408	217	748255027	1088	748260102	1093
745691607	302	745740360	302	747809410	217	748255028	1088	748260105	1093
745691708	302	745740380	302	747809412	217	748255029	1088	748260108	1093
745691809	302	745740460	302	747809481	217	748255030	1088	748260111	1093
745691910	302	745740480	302	747809482	217	748255031	1088	748260114	1093
745701304	302	745740500	302	748104040	1058	748255032	1088	748260121	1093
745701405	302	745742035	302	748240000	1085	748255033	1088	748260127	1093
745701506	302	745742540	302	748240100	1082	748255034	1088	748260140	1093
745701607	302	745743050	302	748240160	1082	748255035	1088	748260152	1093
745701708	302	745744070	302	748240200	1082	748255036	1088	748261430	1093
745701809	302	745746080	302	748240250	1082	748255037	1088	748261964	1092
745701910	302	745747095	302	748240315	1082	748255038	1088	748263152	1093
745702011	302	745747101	303	748240400	1082	748255039	1088	748264152	1093
745702112	302	745747102	303	748240500	1082	748255040	1088	748269200	1093
745702213	302	745747103	303	748240630	1082	748255041	1088	748269201	1093
745702314	302	745747104	303	748250025	1088	748255042	1088	748279015	1082
745702415	302	745747107	303	748250033	1088	748255043	1088	748279063	1082
745702516	302	745800010	421	748250050	1088	748255044	1088	748279073	1082
745702617	302	745800020	421	748252501	1088	748255045	1088	748279083	1082
745702718	302	745800025	421	748252512	1087	748255046	1088	748279094	1082
745702819	302	7458000240	418	748252513	1087	748255047	1088	748279104	1082
745702920	302	7458000450	416	748252514	1087	748255048	1088	748279124	1082
745703021	302	7458000460	416	748252515	1087	748255049	1088	748279165	1082
745703122	302	7458000520	425	748252516	1087	748255050	1088	748279205	1082
745703324	302	7458000540	425	748252517	1087	748255051	1088	748280101	1082
745703425	302	7458000550	417	748252518	1087	748255052	1088	748280102	1082
745721001	301	7458000560	417	748252519	1087	748255053	1088	748280103	1082
745721102	301	7458000610	417	748252520	1087	748255054	1088	748280104	1082
745721203	301	7458000630	417	748252521	1087	748255055	1088	748280105	1082
745721304	301	7458000640	417	748252522	1087	748255056	1088	748280106	1082
745721405	301	7458000662	418	748252523	1087	748255057	1088	748280109	1082
745721506	301	7458000663	419	748252524	1087	748255058	1088	748280124	1082
745721607	301	7458000664	419	748252525	1087	748255059	1088	748297106	1083
745721708	301	7458000701	419	748252526	1087	748255060	1088	748297107	1083
745721809	301	7458000702	419	748252527	1087	748255070	1028	748297108	1083
745721910	301	7458000703	419	748252528	1087	748255071	1028	748297110	1083
745722011	301	7458000704	419	748252529	1087	748255072	1028	748300115	1056
745722112	301	7458000705	419	748252530	1087	748255073	1028	748300125	1056
745722213	301	7458000706	419	748252531	1087	748255080	1088	748300201	1056
745722314	301	7458000707	419	748252532	1087	748255081	1088	748300508	1056
745722415	301	7458000708	419	748252533	1087	748255082	1088	748300601	1056
745722516	301	7458000709	419	748252534	1087	748255083	1088	748301125	1056
745722617	301	7458000710	419	748252535	1087	748260016	1092	748310650	1083
745723021	301	7458000711	419	748252536	1087	748260017	1092	748310800	1083
745723223	301	7458000712	419	748252537	1087	748260019	1092	748310810	1083
745723526	301	7458000713	419	748252538	1087	748260020	1092	748311650	1083
745731001	300	7458000714	419	748252539	1087	748260021	1092	748311800	1083
745731102	300	7458000715	419	748252540	1087	748260022	1092	748311810	1083
745731203	300	7458000716	419	748252541	1087	748260024	1092	748320010	1083
745731304	300	7458000717	419	748252542	1087	748260025	1092	748320020	1083
745731405	300	7458000718	419	748252543	1087	748260027	1092	748320030	1083
745731506	300	7458000719	419	748252544	1087	748260029	1092	748320040	1083
745731607	300	7458000720	419	748252545	1087	748260030	1092	748320070	1083
745731708	300	7458000721	419	748252546	1087	748260032	1092	748401100	1059
745731809	300	7458000722	419	748252547	1087	748260033	1092	748401200	1059
745731910	301	7458000723	419	748252548	1087	748260035	1092	748411075	1054
745732011	301	7458000724	419	748252549	1087	748260037	1092	748411102	1054
745732112	301	7458000725	419	748252550	1087	748260038	1092	748411203	1054
745732213	301	7458000726	419	748252551	1087	748260040	1092	748411304	1054
745732314	301	7458000727	373	748252552	1087	748260041	1092	748411405	1054
745732415	301	747141015	1054	748252553	1087	748260043	1092	748411506	1054
745732516	301	747141217	1054	748252554	1087	748260044	1092	748411510	1054
745732617	301	747141420	1054	748252555	1087	748260046	1092	748411512	1054
745732718	301	747141620	1054	748252556	1087	748260048	1092	748411513	1054
745732819	301	747141825	1054	748252557	1087	748260051	1092	748411514	1054
745732920	301	747143050	1054	748252558	1087	748260052	1092	748411520	1054
745733021	301	747144070	1054	748252559	1087	748260054	1092	748411534	1054
745733122	301	747145080	1054	748252560	1087	748260057	1092	748411607	1054
745733223	301	747146100	1054	748255001	1088	748260059	1092	748411708	1054
745733324	301	747148125	1054	748255012	1087	748260060	1092	748411710	1054
745733425	301	747150310	1057	748255013	1087	748260064	1093	748411712	1054
745733526	301	747801004	217	748255014	1087	748260065	1093	748411714	1054
745740100	302	747801005	217	748255015	1087	748260067	1093	748411715	1054
745740120	302	747801006	217	748255016	1087	748260068	1093	748411716	1054
745740140	302	747801008	217	748255017	1087	748260070	1093	748411718	1054
745740160	302	747801010	217	748255018	1087	748260073	1093	748411720	1054
745740180	302	747802040	217	748255019	1087	748260076	1093	748411734	1054
745740200	302	747802050	217	748255020	1088	748260079	1093	748411738	1054
745740220	302	747802060	217	748255021	1088	748260083	1093	748411809	1054
745740240	302	747802080	217	748255022	1088	748260086	1093	748411910	1054
745740260	302	747804001	217	748255023	1088	748260089	1093	748412011	1054
745740280	302	747805001	217	748255024	1088	748260092	1093	748412112	1054
745740300	302	747809001	217	748255025	1088	748260095	1093	748412213	1054

Order nr.	Pag.	Order nr.	Pag.	Order nr.	Pag.	Order nr.	Pag.	Order nr.	Pag.
748412314	1054	748441115	1054	754750026	402	754752659	377	754752745	381
748412415	1054	748442175	1054	754750070	399	754752660	377	754752747	381
748412516	1054	748448125	1054	754750071	399	754752661	377	754752748	381
748412617	1054	748449125	1054	754750072	399	754752662	377	754752749	381
748412718	1054	748529000	1056	754750073	399	754752663	377	754752750	381
748412819	1054	748529000	246	754750074	399	754752664	377	754752751	382
748412920	1054	749202000	1060	754750075	399	754752665	377	754752752	382
748413021	1054	749551102	1026	754750076	399	754752666	377	754752754	382
748413223	1054	749601021	1027	754750500	413	754752667	377	754752756	382
748413324	1054	749601031	1027	754751000	412	754752668	377	754752757	382
748413425	1054	749601052	1027	754751001	225	754752669	377	754752758	382
748413526	1054	749601053	1027	754751103	410	754752670	377	754752759	382
748413627	1054	749601054	1027	754751105	410	754752671	377	754752760	382
748413728	1054	749611012	1027	754751108	410	754752672	377	754752762	382
748413829	1054	749611021	1027	754751110	414	754752673	377	754752763	382
748413930	1054	749611033	1027	754751112	410	754752674	377	754752764	382
748414031	1054	749611042	1027	754751120	410	754752675	377	754752765	382
748414132	1054	749611044	1027	754751131	414	754752676	377	754752766	382
748414233	1054	749611053	1027	754751210	402	754752677	377	754752767	382
748414334	1054	749611054	1027	754751212	405	754752678	377	754752769	382
748414435	1054	749642018	1027	754751225	405	754752679	377	754752771	382
748414536	1054	749643018	1027	754751227	405	754752680	377	754752773	382
748420100	1056	749644018	1027	754751300	410	754752681	377	754752774	382
748420101	1056	749644022	1027	754751314	400	754752682	378	754752775	382
748420102	1056	749651001	1026	754751340	400	754752683	378	754752776	382
748420103	1056	749651203	1026	754751350	400	754752684	378	754752778	382
748420165	1056	749651506	1026	754751410	402	754752685	378	754752779	382
748420205	1056	749651607	1026	754751442	403	754752686	378	754752780	382
748420207	1056	749651708	1026	754751500	410	754752687	378	754752781	382
748420259	1056	749661910	1026	754751810	374	754752688	378	754752782	382
748421112	1056	751001500	532	754751910	374	754752689	378	754752783	383
748421203	1055	751001501	532	754751990	403	754752690	378	754752785	383
748421204	1055	751001503	534	754752000	374	754752691	378	754752787	383
748421211	1055	751001504	534	754752010	374	754752692	378	754752789	383
748421212	1055	751001505	535	754752013	374	754752693	378	754752790	383
748421213	1055	751001506	533	754752019	374	754752694	378	754752791	383
748421401	1055	751001507	533	754752020	374	754752695	378	754752792	383
748421402	1055	751002000	532	754752021	375	754752696	378	754752794	383
748421411	1055	751002001	532	754752022	375	754752697	378	754752795	383
748421412	1055	751002004	534	754752023	375	754752698	378	754752796	383
748423011	1056	751002008	534	754752024	375	754752699	378	754752797	383
748423814	1056	751002009	535	754752025	375	754752700	378	754752798	383
748431275	1055	751002017	535	754752026	375	754752701	378	754752799	383
748431281	1055	751002018	535	754752027	375	754752702	378	754752801	383
748431300	1055	751002019	535	754752028	375	754752703	378	754752802	383
748431301	1055	751002020	535	754752029	375	754752704	378	754752804	383
748431302	1055	751002021	533	754752030	375	754752705	378	754752805	383
748431303	1055	751002022	533	754752031	375	754752706	378	754752806	384
748431304	1055	751500580	539	754752220	410	754752707	379	754752807	384
748431305	1055	751501102	538	754752221	410	754752708	379	754752809	384
748431306	1055	751501203	540	754752222	400	754752709	379	754752810	384
748431311	1055	751501210	540	754752225	401	754752710	379	754752811	384
748431321	1055	751501304	540	754752260	411	754752711	379	754752812	384
748431331	1055	751503000	64	754752261	411	754752712	379	754752813	384
748431341	1055	751600010	538	754752262	411	754752713	379	754752814	384
748431351	1055	751601000	538	754752270	412	754752714	379	754752816	384
748431361	1055	751607000	538	754752286	412	754752715	379	754752817	384
748431381	1055	751981001	394	754752292	412	754752716	379	754752819	384
748431391	1055	751985181	395	754752500	374	754752717	379	754752820	384
748431401	1055	751985182	395	754752610	376	754752718	380	754752821	384
748431411	1055	751985191	395	754752611	376	754752719	380	754752822	384
748431431	1055	751985192	395	754752612	376	754752720	380	754752823	384
748431441	1055	751985200	395	754752613	376	754752721	380	754752824	384
748431451	1055	751985201	395	754752614	376	754752722	380	754752826	384
748431471	1055	751985202	395	754752615	376	754752723	380	754752828	384
748431481	1055	751985204	395	754752616	376	754752724	380	754752829	384
748431491	1055	751987010	394	754752617	376	754752725	380	754752830	384
748431511	1055	751987013	394	754752618	376	754752726	380	754752831	384
748431521	1055	751987023	395	754752619	376	754752727	380	754752832	384
748431531	1055	751987025	394	754752620	376	754752728	380	754752833	384
748431541	1055	751987026	394	754752621	376	754752729	380	754752834	384
748431561	1055	751987028	394	754752622	376	754752730	380	754752836	384
748431581	1055	751987029	395	754752623	376	754752731	380	754752837	384
748431591	1055	751987030	395	754752624	376	754752732	380	754752838	385
748431601	1055	751987032	394	754752625	376	754752733	380	754752839	385
748431611	1055	751988120	62	754752626	376	754752734	380	754752840	385
748431621	1055	751988124	537	754752627	376	754752735	380	754752841	385
748431631	1055	751988125	537	754752628	376	754752736	381	754752842	385
748440305	1054	752401101	132	754752629	376	754752737	381	754752843	385
748440407	1054	752402000	132	754752630	376	754752740	381	754752844	385
748440508	1054	754750020	403	754752631	376	754752741	381	754752845	385
748440610	1054	754750020	313	754752632	376	754752742	381	754752846	385
748440710	1054	754750022	413	754752633	376	754752743	381	754752847	385
748441015	1054	754750025	402	754752658	377	754752744	381	754752848	385

NUMERIEKE INDEX

Order nr.	Pag.	Order nr.	Pag.	Order nr.	Pag.	Order nr.	Pag.	Order nr.	Pag.
754752849	385	756200730	406	758120195	544	758136968	417	758621255	366
754752850	385	756200735	407	758120265	544	758136969	417	758621400	398
754752851	385	756200745	407	758120445	545	758136970	421	758621500	366
754752956	375	756202520	409	758120446	546	758136971	421	758621600	405
754752957	375	756203001	405	758120700	545	758136972	421	758622612	367
754752958	375	756203002	405	758120905	546	758136973	420	758623000	366
754752959	375	757001010	227	758121100	544	758136974	420	758623100	366
754752960	375	757001111	227	758121550	544	758136975	420	758624151	367
754752961	375	757001212	227	758121670	544	758136976	420	758624250	366
754752962	375	757001313	227	758121800	544	758136977	420	758624255	366
754752963	375	757001414	227	758136210	52	758136978	421	758625610	367
754752964	375	757001515	227	758136330	52	758136979	421	758625612	367
754752965	375	757001616	227	758136430	52	758136980	421	758702551	368
754752966	375	757001717	227	758136515	52	758201228	387	758704000	226
754752967	375	757001818	227	758136518	52	758201230	387	758710001	368
754752968	375	757001919	227	758136522	52	758201666	391	758725050	371
754752969	375	757002020	227	758136526	52	758204302	389	758725060	371
754752970	375	757002110	227	758136575	416	758204303	389	761000067	488
754752975	385	757002112	227	758136596	418	758204402	389	761000068	488
754752976	385	757002121	227	758136597	418	758204403	389	761000069	488
754752977	385	757002222	227	758136598	418	758204502	389	761000070	488
754752978	385	757002323	227	758136637	422	758204503	389	761000094	530
754752979	385	757002424	227	758136639	421	758205011	391	761000095	530
754752980	385	757002525	227	758136640	421	758205012	391	761000096	530
754752981	385	757002626	227	758136651	421	758208500	388	761000097	530
754752982	385	757002727	227	758136652	422	758208501	391	761000098	530
754752983	385	757002828	227	758136656	422	758208600	388	761000099	530
754752984	385	757003030	227	758136657	421	758209670	391	761000100	530
754752990	373	757004040	227	758136658	422	758209671	391	761000101	530
754752991	373	757005050	227	758136692	424	758301508	391	761000102	530
754752992	373	757006060	227	758136696	424	758301512	391	761000103	530
754752993	373	757007070	227	758136709	424	758301513	391	761000104	530
754752994	373	757008080	227	758136710	424	758302314	391	761000105	530
754753000	411	757009090	227	758136714	416	758302315	391	761000106	530
754753005	401	757160505	707	758136716	416	758303223	391	761000107	530
754753011	399	757161010	707	758136718	424	758304811	391	761000108	530
754753025	401	757161614	708	758136729	425	758305617	391	761000109	530
754753030	405	757161616	708	758136754	425	758307956	390	761000110	530
754753080	401	757161621	709	758136755	425	758307959	390	761000111	530
754753115	401	757161623	709	758136756	425	758307970	390	761000112	526
754753200	401	757161627	710	758136799	420	758307973	390	761000113	526
754753350	401	757161628	710	758136855	423	758307981	391	761000114	530
754753990	401	757161629	710	758136855	424	758307989	390	761000116	520
754753995	401	757161630	710	758136856	422	758307992	390	761000118	520
754755200	702	757170075	704	758136858	373	758308000	391	761000120	520
754756030	401	757170100	705	758136859	422	758308047	391	761000122	520
754756060	405	757170150	701	758136861	422	758412002	538	761000124	520
754756100	414	757170220	703	758136863	422	758580020	393	761000125	510
754756120	415	757170520	704	758136864	422	758580040	393	761000126	506
754756161	415	757172020	706	758136865	422	758580140	393	761000127	506
754756200	415	757173030	706	758136866	423	758580160	393	761000128	506
754756262	415	757175050	706	758136867	423	758580161	393	761000129	506
754758310	700	757176541	710	758136868	416	758580162	393	761000130	506
754758311	710	757176561	710	758136869	416	758580163	393	761000131	506
754759999	247	757176581	710	758136871	416	758580164	393	761000132	506
754773030	243	757176661	710	758136872	416	758580165	393	761000133	506
754800102	418	757491011	717	758136873	416	758580166	393	761000134	506
754800103	418	757491012	718	758136874	416	758580167	393	761000135	506
754800104	418	757491015	718	758136878	416	758580168	393	761000136	506
754800150	418	757491018	718	758136880	424	758580169	393	761000137	506
755000101	547	757491040	717	758136883	424	758580259	392	761000138	506
755002000	224	757491055	716	758136891	423	758580525	392	761000139	506
755002020	547	757491070	716	758136893	423	758580750	392	761000140	510
755002500	224	757491090	717	758136895	423	758581025	392	761000141	510
755003000	224	757491099	717	758136896	423	758581060	392	761000142	506
755003030	547	757501001	720	758136897	424	758581150	392	761000143	506
755004040	547	757501102	720	758136898	423	758581525	392	761000144	506
755005050	547	757501203	720	758136899	423	758582025	392	761000145	506
755009250	224	757501304	720	758136901	424	758582060	392	761000146	506
755009300	224	757501405	720	758136906	425	758583000	392	761000147	506
756000510	398	757501506	720	758136909	425	758583030	392	761000148	506
756001006	398	757501507	720	758136917	420	758583200	393	761000149	506
756002006	398	757501508	720	758136918	420	758585030	392	761000150	506
756183650	405	757502212	720	758136926	422	758601032	413	761000151	506
756200605	408	757502216	720	758136944	417	758611001	386	761000152	506
756200620	408	757570020	395	758136946	417	758611010	386	761000153	506
756200625	408	757570050	395	758136950	417	758611012	386	761000154	506
756200626	409	757571000	396	758136952	417	758611250	386	761000155	506
756200627	409	757571010	396	758136958	417	758612040	386	761000156	506
756200628	409	757571150	396	758136959	417	758613060	386	761000157	506
756200630	408	757571212	396	758136961	417	758613070	386	761000158	510
756200705	406	757572525	396	758136962	417	758621001	398	761000159	510
756200707	406	757575050	396	758136965	417	758621240	366	761000160	506
756200720	407	757575151	396	758136966	417	758621250	366	761000161	506

Order nr.	Pag.	Order nr.	Pag.	Order nr.	Pag.	Order nr.	Pag.	Order nr.	Pag.
761000162	506	761000314	491	761000401	464	761000568	472	761000654	480
761000163	506	761000316	491	761000402	464	761000569	472	761000655	480
761000164	506	761000317	491	761000403	464	761000570	472	761000656	480
761000165	506	761000318	491	761000404	464	761000571	472	761000657	480
761000166	506	761000319	491	761000405	464	761000572	472	761000658	480
761000167	506	761000320	491	761000406	464	761000573	472	761000659	480
761000168	506	761000321	491	761000407	464	761000574	472	761000660	480
761000169	506	761000322	460	761000408	464	761000575	472	761000661	480
761000170	506	761000323	460	761000409	464	761000576	472	761000662	480
761000171	506	761000324	460	761000410	464	761000577	493	761000681	494
761000172	506	761000325	460	761000411	464	761000578	493	761000682	494
761000173	506	761000326	460	761000412	464	761000579	493	761000711	517
761000174	506	761000327	460	761000413	464	761000580	493	761000712	517
761000175	506	761000328	460	761000414	464	761000581	472	761000734	494
761000176	510	761000329	460	761000415	464	761000582	472	761000735	494
761000195	497	761000330	460	761000416	491	761000583	472	761000736	494
761000197	497	761000331	460	761000417	491	761000584	472	761000737	494
761000199	499	761000332	460	761000418	491	761000585	472	761000738	494
761000200	498	761000333	460	761000419	491	761000586	472	761000739	494
761000201	497	761000334	460	761000420	491	761000587	472	761000740	494
761000203	499	761000335	460	761000421	491	761000588	472	761000741	494
761000204	498	761000336	460	761000423	468	761000589	472	761000743	494
761000205	499	761000337	460	761000424	468	761000590	472	761000744	494
761000206	498	761000338	460	761000425	468	761000591	472	761000745	464
761000207	497	761000339	460	761000426	468	761000592	472	761000746	464
761000209	497	761000340	460	761000427	468	761000593	472	761000747	464
761000211	499	761000341	460	761000428	468	761000594	493	761000748	464
761000212	498	761000342	460	761000429	468	761000595	493	761000749	464
761000213	497	761000343	460	761000430	468	761000596	493	761000750	464
761000215	499	761000344	460	761000431	468	761000597	493	761000751	464
761000216	498	761000345	492	761000432	468	761000598	516	761000752	464
761000217	499	761000346	491	761000433	468	761000600	493	761000753	464
761000218	498	761000347	491	761000434	468	761000601	493	761000754	494
761000219	497	761000348	491	761000435	468	761000602	493	761000755	494
761000222	497	761000349	491	761000436	468	761000603	493	761000757	468
761000225	499	761000350	491	761000437	468	761000604	476	761000758	468
761000226	498	761000351	491	761000438	468	761000605	476	761000759	468
761000227	497	761000352	460	761000439	468	761000606	476	761000760	468
761000229	499	761000353	460	761000440	468	761000607	476	761000761	468
761000230	498	761000354	460	761000441	468	761000608	476	761000762	468
761000231	499	761000355	460	761000442	468	761000609	476	761000763	468
761000232	498	761000356	460	761000443	468	761000610	476	761000764	468
761000233	497	761000357	460	761000444	468	761000611	476	761000765	468
761000235	497	761000358	460	761000445	468	761000612	476	761000773	495
761000237	499	761000359	460	761000446	468	761000613	476	761000774	495
761000238	498	761000360	460	761000447	468	761000614	476	761000775	495
761000239	497	761000361	460	761000448	468	761000615	476	761000776	495
761000241	499	761000362	460	761000449	468	761000616	476	761000777	495
761000242	498	761000363	460	761000450	468	761000617	476	761000778	495
761000243	499	761000364	460	761000451	468	761000618	476	761000779	495
761000244	498	761000365	491	761000452	468	761000619	476	761000780	495
761000245	497	761000366	491	761000453	468	761000620	476	761000782	495
761000247	497	761000367	491	761000454	468	761000621	476	761000783	495
761000249	499	761000368	491	761000455	468	761000622	476	761000784	476
761000250	498	761000369	491	761000456	468	761000623	476	761000785	476
761000251	497	761000370	491	761000457	468	761000624	476	761000786	476
761000253	499	761000372	516	761000458	468	761000625	476	761000787	476
761000254	498	761000374	491	761000481	492	761000626	476	761000788	476
761000255	499	761000375	491	761000482	492	761000627	476	761000789	476
761000256	498	761000376	491	761000483	492	761000628	476	761000790	476
761000287	500	761000377	491	761000522	65	761000629	476	761000791	476
761000288	500	761000378	491	761000524	65	761000630	476	761000792	476
761000289	500	761000379	491	761000526	65	761000631	493	761000793	495
761000290	500	761000380	464	761000528	65	761000632	493	761000794	495
761000291	500	761000381	464	761000536	65	761000633	493	761000796	480
761000293	435	761000382	464	761000537	65	761000634	493	761000797	480
761000294	435	761000383	464	761000538	65	761000636	480	761000798	480
761000295	435	761000384	464	761000550	493	761000637	480	761000799	480
761000297	435	761000385	464	761000551	493	761000638	480	761000800	480
761000299	491	761000386	464	761000552	493	761000639	480	761000801	480
761000300	491	761000387	464	761000553	493	761000640	480	761000802	480
761000301	491	761000388	464	761000554	493	761000641	480	761000803	480
761000302	491	761000389	464	761000555	493	761000642	480	761000804	480
761000303	491	761000390	464	761000556	493	761000643	480	761000817	436
761000304	491	761000391	464	761000557	493	761000644	480	761000828	436
761000305	492	761000392	464	761000559	493	761000645	480	761000856	437
761000306	492	761000393	464	761000560	493	761000646	480	761000857	438
761000307	492	761000394	464	761000561	493	761000647	480	761000858	438
761000308	492	761000395	464	761000562	493	761000648	480	761000859	438
761000309	491	761000396	464	761000563	472	761000649	480	761000860	438
761000310	491	761000397	464	761000564	472	761000650	480	761000861	438
761000311	491	761000398	464	761000565	472	761000651	480	761000862	438
761000312	491	761000399	464	761000566	472	761000652	480	761000863	437
761000313	491	761000400	464	761000567	472	761000653	480	761000864	438

NUMERIEKE INDEX

Order nr.	Pag.	Order nr.	Pag.	Order nr.	Pag.	Order nr.	Pag.	Order nr.	Pag.
761000865	438	761001006	511	761001163	505	761001295	452	761001405	444
761000866	438	761001007	514	761001164	505	761001296	452	761001406	444
761000867	438	761001008	515	761001165	505	761001297	452	761001408	444
761000868	438	761001009	512	761001166	502	761001298	452	761001409	444
761000869	438	761001010	513	761001167	502	761001299	452	761001410	444
761000870	437	761001011	511	761001168	502	761001300	452	761001411	444
761000871	438	761001012	514	761001172	504	761001301	452	761001412	444
761000872	438	761001013	515	761001173	504	761001302	452	761001413	444
761000873	438	761001014	512	761001174	504	761001303	452	761001414	444
761000874	438	761001015	513	761001177	505	761001304	452	761001416	446
761000875	438	761001016	511	761001178	505	761001305	452	761001417	446
761000876	438	761001017	514	761001179	505	761001306	452	761001418	446
761000879	487	761001018	515	761001180	505	761001307	452	761001419	446
761000880	487	761001019	512	761001181	505	761001308	452	761001420	446
761000881	487	761001020	511	761001182	505	761001309	452	761001421	446
761000882	487	761001021	514	761001183	502	761001310	452	761001422	446
761000883	487	761001022	515	761001184	502	761001311	452	761001423	446
761000884	487	761001024	512	761001185	502	761001312	452	761001424	446
761000886	487	761001025	511	761001189	504	761001313	452	761001429	450
761000887	487	761001026	514	761001190	504	761001314	452	761001430	450
761000888	487	761001027	515	761001191	504	761001315	452	761001431	450
761000889	487	761001028	512	761001195	505	761001316	452	761001432	450
761000890	487	761001029	511	761001196	505	761001317	452	761001433	450
761000891	487	761001030	514	761001197	505	761001318	452	761001434	450
761000893	487	761001031	515	761001198	505	761001319	452	761001435	450
761000894	487	761001032	517	761001199	505	761001320	452	761001436	447
761000895	487	761001059	64	761001200	505	761001321	452	761001437	447
761000896	487	761001060	64	761001201	502	761001322	452	761001451	447
761000897	487	761001061	65	761001202	502	761001323	452	761001452	456
761000898	487	761001062	65	761001203	502	761001324	452	761001453	456
761000900	487	761001063	65	761001207	504	761001325	452	761001454	456
761000901	487	761001065	527	761001208	504	761001326	452	761001455	456
761000902	487	761001066	527	761001209	504	761001327	452	761001458	456
761000903	487	761001067	527	761001212	505	761001328	452	761001745	489
761000904	487	761001068	527	761001213	505	761001329	452	761001746	489
761000905	487	761001069	527	761001214	505	761001330	452	761001748	489
761000914	500	761001070	527	761001215	505	761001331	452	761001749	489
761000915	434	761001071	527	761001216	505	761001332	452	761001750	489
761000916	434	761001072	527	761001217	505	761001333	452	761001751	489
761000917	434	761001073	527	761001218	502	761001334	452	761001752	489
761000918	500	761001074	527	761001219	502	761001335	452	761001753	489
761000919	500	761001075	527	761001220	502	761001336	452	761001756	489
761000920	65	761001076	528	761001224	504	761001337	452	761001757	489
761000921	65	761001077	527	761001225	504	761001338	452	761001758	490
761000936	495	761001078	528	761001226	504	761001339	456	761001759	490
761000937	495	761001079	528	761001252	496	761001340	456	761001760	490
761000939	516	761001080	528	761001253	496	761001341	456	761001761	490
761000941	495	761001081	528	761001254	496	761001347	441	761001762	489
761000942	495	761001085	528	761001255	500	761001348	441	761001763	489
761000944	484	761001086	528	761001256	500	761001349	441	761001764	489
761000945	484	761001087	528	761001257	500	761001350	441	761001765	490
761000946	484	761001088	528	761001258	500	761001351	441	761001766	490
761000947	484	761001089	528	761001259	500	761001352	441	761001767	490
761000948	484	761001090	527	761001260	440	761001353	441	761001768	490
761000949	484	761001097	528	761001261	440	761001354	441	761001769	490
761000950	484	761001098	528	761001262	440	761001355	441	761001770	490
761000951	484	761001106	518	761001263	440	761001356	441	761001773	489
761000952	484	761001107	529	761001265	440	761001357	441	761001774	489
761000953	495	761001108	531	761001266	440	761001358	441	761001775	489
761000954	495	761001109	518	761001267	440	761001361	448	761001776	489
761000956	495	761001110	529	761001268	440	761001362	448	761001777	489
761000957	495	761001111	518	761001269	440	761001363	442	761001778	489
761000959	516	761001112	529	761001270	440	761001364	442	761001779	489
761000961	495	761001113	518	761001272	440	761001372	442	761001780	489
761000962	495	761001114	529	761001273	440	761001373	442	761001781	489
761000964	484	761001115	518	761001274	440	761001374	442	761001782	489
761000965	484	761001116	529	761001275	440	761001375	442	761001783	525
761000966	484	761001117	65	761001276	440	761001376	442	761001784	525
761000967	484	761001118	65	761001279	452	761001377	442	761001785	525
761000968	484	761001142	505	761001280	452	761001378	442	761001786	525
761000969	484	761001143	505	761001281	452	761001379	442	761001787	525
761000970	484	761001144	505	761001282	452	761001380	442	761001788	525
761000971	484	761001145	505	761001283	452	761001383	449	761001789	525
761000972	484	761001146	505	761001284	452	761001384	449	761001790	525
761000973	495	761001147	505	761001285	452	761001395	444	761001791	525
761000974	495	761001148	502	761001286	452	761001396	444	761001792	525
761000998	512	761001149	502	761001287	452	761001397	444	761001793	525
761000999	513	761001150	502	761001288	452	761001398	444	761001794	525
761001000	512	761001154	504	761001289	452	761001399	444	761001795	525
761001001	513	761001155	504	761001290	452	761001400	444	761001796	525
761001002	512	761001156	504	761001291	452	761001401	444	761001805	525
761001003	513	761001160	505	761001292	452	761001402	444	761001806	525
761001004	512	761001161	505	761001293	452	761001403	444	761001807	525
761001005	513	761001162	505	761001294	452	761001404	444	761001808	524

NUMERIEKE INDEX

Order nr.	Pag.	Order nr.	Pag.	Order nr.	Pag.	Order nr.	Pag.	Order nr.	Pag.
761020616	478	761033581	478	761033676	483	790000596	1031	790002955	1028
761020617	478	761033582	478	761033677	483	790000597	1031	790002956	1028
761020618	478	761033583	478	761033678	483	790001091	1049	790002957	1028
761020619	478	761033584	482	761033679	483	790001092	1049	790002958	1028
761020620	478	761033585	482	761033680	483	790001093	1049	790002959	1028
761020621	478	761033586	482	761033681	483	790001094	1049	790002960	1028
761020622	478	761033587	482	761033682	483	790001705	1030	790002961	1028
761020623	478	761033588	482	761033683	483	790001706	1030	790003942	1091
761020624	478	761033589	482	761033684	483	790001707	1030	790003943	1091
761020625	478	761033590	482	763504000	228	790001708	1030	790003944	1091
761020626	478	761033591	482	763505000	228	790001709	1030	790003945	1091
761020627	478	761033592	482	763506000	228	790001710	1030	790003947	1091
761020628	478	761033593	475	763606000	228	790001711	1030	790003948	1091
761020629	478	761033594	475	770101210	219	790001712	1030	790003950	1091
761020630	478	761033595	475	770101615	219	790001713	1030	790003952	1091
761020645	482	761033596	475	770101622	221	790001714	1030	790003955	275
761020646	482	761033597	475	770101633	221	790001715	1030	790003964	275
761020647	482	761033598	475	770101644	221	790001716	1030	790004162	917
761020648	482	761033599	475	770102015	219	790001717	1030	790004164	917
761020649	482	761033600	475	770102033	221	790001718	1030	790004166	917
761020650	482	761033601	475	770102520	219	790001719	1030	790004168	917
761020651	482	761033602	479	770102522	221	790001720	1030	790004169	917
761020652	482	761033603	479	770102533	221	790001721	1030	790004170	917
761020653	482	761033604	479	770102544	221	790001722	1030	790004172	917
761020654	482	761033605	479	770103033	221	790001723	1030	790004173	917
761020655	482	761033606	479	770103544	221	790001724	1030	790004180	917
761020656	482	761033607	479	770104033	221	790001725	1030	790004181	917
761020657	482	761033608	479	770105220	219	790001726	1030	790004182	917
761020658	482	761033609	479	770105244	221	790001727	1030	790004185	917
761020659	482	761033610	479	770106105	219	790001728	1030	790004186	917
761020660	482	761033611	483	770108010	219	790001729	1030	790004187	917
761020661	482	761033612	483	770108022	221	790001730	1030	790004188	917
761020662	482	761033613	483	770108033	221	790001731	1030	790004189	917
761020745	466	761033614	483	770108440	221	790001732	1030	790004190	917
761020746	466	761033615	483	770109999	219	790001733	1030	790004191	917
761020747	466	761033616	483	770203720	219	790001734	1030	790004192	917
761020748	466	761033617	483	770205220	219	790001735	1030	790004193	917
761020749	466	761033618	483	770301212	220	790001736	1030	790004449	916
761020750	466	761033619	483	770301222	221	790001737	1030	790004450	916
761020751	466	761033621	474	770301244	221	790001738	1030	790004451	916
761020752	466	761033632	474	770301616	220	790001739	1030	790004454	916
761020753	466	761033633	474	770301622	221	790001740	1030	790004697	1034
761020757	470	761033634	474	770301644	221	790001741	1030	790004698	1034
761020758	470	761033635	474	770302333	221	790001742	1030	790007200	1061
761020759	470	761033636	474	770302344	221	790001743	1030	790007203	1045
761020760	470	761033637	474	770308022	221	790001744	1030	790007210	1029
761020761	470	761033638	474	770308044	221	790001745	1030	790007214	1034
761020762	470	761033639	474	770308080	220	790001746	1030	790007216	1034
761020763	470	761033640	478	770401212	220	790001747	1030	790007222	1091
761020764	470	761033641	478	770401616	220	790001748	1030	790007223	1091
761020765	470	761033642	478	770402320	220	790001749	1030	790007224	1091
761021950	462	761033643	478	770408080	220	790001750	1030	790007225	1091
761021951	462	761033644	478	770504022	221	790001751	1030	790007226	1091
761021952	462	761033645	478	770504044	221	790001752	1030	790007227	1030
761021953	462	761033646	478	770506022	221	790001753	1030	790007228	1030
761021954	462	761033647	478	770506044	221	790001754	1030	790007230	1028
761021955	462	761033648	478	770506060	219	790001755	1030	790007231	1028
761021956	462	761033649	482	770508022	221	790001756	1030	790007232	1028
761021957	462	761033650	482	770508044	221	790001757	1030	790007234	1034
761021958	462	761033651	482	770508080	219	790001758	1030	790007235	1034
761021964	463	761033652	482	770604060	219	790001759	1030	790007236	1034
761021965	463	761033653	482	770606060	219	790001760	1030	790007237	1034
761021966	463	761033654	482	770608080	219	790001761	1030	790007238	1034
761021967	463	761033655	482	770702013	220	790001998	1029	790007240	1035
761021968	467	761033656	482	770802013	220	790002000	1029	790007241	1035
761021969	467	761033657	482	770902222	220	790002001	1029	790007243	1035
761021970	467	761033658	475	771002222	220	790002003	1029	790007244	1035
761021971	467	761033659	475	790000004	1049	790002004	1029	790007246	1035
761021972	467	761033660	475	790000005	1049	790002019	1029	790007247	1035
761033566	474	761033661	475	790000013	1051	790002051	1029	790007248	1035
761033567	474	761033662	475	790000014	1051	790002052	1029	790007250	1035
761033568	474	761033663	475	790000017	1051	790002053	1029	790007251	1035
761033569	474	761033664	475	790000021	1051	790002058	1029	790007252	1035
761033570	474	761033665	475	790000025	1050	790002076	1029	790007253	1035
761033571	474	761033666	475	790000026	1050	790002085	1029	790007254	1035
761033572	474	761033667	479	790000027	1050	790002934	1028	790007255	1035
761033573	474	761033668	479	790000032	1049	790002935	1028	790007256	1035
761033574	474	761033669	479	790000034	1050	790002936	1028	790007257	1035
761033575	478	761033670	479	790000070	1047	790002937	1028	790007258	1035
761033576	478	761033671	479	790000074	1048	790002938	1028	790007259	1035
761033577	478	761033672	479	790000051	1032	790002939	1028	790007260	1035
761033578	478	761033673	479	790000059	1031	790002949	1028	790007261	1035
761033579	478	761033674	479	790000059	1031	790002952	1028	790007262	1035
761033580	478	761033675	479	790000059	1031	790002953	1028	790007263	1035

790007264	1035	790008692	710	790302541	1086	790400002	744	790401020	747
790007265	1035	790008693	710	790302542	1086	790400004	744	790401022	747
790007266	1035	790008694	710	790302543	1086	790400006	744	790401024	747
790007267	1035	790008695	710	790302544	1086	790400008	744	790401026	747
790007268	1035	790008696	710	790302545	1086	790400010	744	790401028	747
790007269	1035	790008697	710	790302546	1086	790400012	744	790401030	747
790007270	1035	790008698	710	790302547	1086	790400014	744	790401032	747
790007271	1035	790008699	710	790302548	1086	790400016	744	790401034	747
790007272	1035	790008702	1022	790302549	1086	790400018	744	790401036	747
790007288	1095	790008704	1022	790302550	1086	790400020	744	790401038	747
790007305	1051	790008706	1022	790302551	1086	790400022	744	790401040	747
790007306	1051	790008794	1023	790302552	1086	790400024	744	790401042	747
790007307	1051	790008796	1023	790302553	1086	790400026	744	790401044	747
790007308	1051	790008801	1024	790302554	1086	790400028	744	790401046	747
790007315	1048	790008804	1024	790302555	1086	790400030	744	790401048	747
790007317	1048	790008807	1024	790302556	1086	790400032	744	790401050	747
790007319	1048	790008823	1025	790302557	1086	790400034	744	790401052	747
790007322	1035	790008825	1025	790302558	1086	790400036	744	790401054	747
790007323	1035	790008826	1025	790302559	1086	790400038	744	790401056	747
790007324	1035	790008828	1024	790302560	1086	790400040	744	790401058	747
790007325	1035	790008829	1024	790302561	1086	790400042	744	790401060	747
790007326	1035	790008830	1024	790302562	1086	790400044	744	790401062	747
790007327	1035	790008835	1025	790302563	1086	790400046	744	790401064	747
790007328	1035	790008836	1025	790302564	1086	790400048	744	790401066	747
790007329	1035	790008837	1025	790302565	1086	790400050	744	790401068	747
790007330	1035	790008838	1025	790302600	1087	790400052	745	790401070	747
790008053	1095	790008859	1023	790302601	1087	790400054	745	790402002	748
790008057	1095	790008860	1023	790302631	1087	790400056	745	790402004	748
790008080	1095	790008864	1023	790302633	1087	790400058	745	790402006	748
790008093	1094	790008865	1023	790302635	1087	790400060	745	790402008	748
790008094	1094	790011000	1034	790305012	1086	790400062	745	790402010	748
790008151	1094	790023034	1027	790305013	1086	790400064	745	790402012	748
790008152	1094	790023035	1027	790305014	1086	790400066	745	790402014	748
790008153	1094	790023036	1027	790305015	1086	790400068	745	790402016	748
790008154	1094	790023037	1027	790305016	1086	790400070	745	790402018	748
790008188	1094	790023038	1027	790305017	1086	790400072	745	790402020	748
790008189	1094	790023039	1030	790305018	1086	790400074	745	790402022	748
790008190	1094	790023079	1027	790305019	1086	790400076	745	790402024	748
790008646	710	790023105	742	790305020	1086	790400078	745	790402026	748
790008647	710	790023115	742	790305021	1086	790400080	745	790402028	748
790008648	710	790024000	839	790305022	1086	790400082	745	790402030	748
790008649	710	790024004	1028	790305023	1086	790400084	745	790402032	748
790008650	710	790024018	1041	790305024	1086	790400086	745	790402034	748
790008651	710	790024020	1041	790305025	1086	790400088	745	790402036	748
790008652	710	790024022	1041	790305026	1086	790400090	745	790402038	748
790008653	710	790024032	1027	790305027	1086	790400092	745	790402040	748
790008654	710	790024050	771	790305028	1086	790400094	745	790402042	748
790008655	710	790024053	772	790305029	1086	790400096	745	790402044	748
790008656	710	790025000	768	790305030	1086	790400098	745	790402046	748
790008657	710	790025002	768	790305031	1086	790400100	745	790402048	748
790008658	710	790025004	768	790305032	1086	790400102	745	790402050	748
790008659	710	790025111	714	790305033	1086	790400104	745	790402052	748
790008660	710	790025112	714	790305034	1086	790400106	745	790402054	748
790008661	710	790025113	714	790305035	1086	790400108	745	790402056	748
790008662	710	790302500	1087	790305036	1086	790400110	745	790402058	748
790008663	710	790302512	1086	790305037	1086	790400112	746	790402060	748
790008664	710	790302513	1086	790305038	1086	790400114	746	790402062	748
790008665	710	790302514	1086	790305039	1086	790400116	746	790402064	748
790008666	710	790302515	1086	790305040	1086	790400118	746	790402066	748
790008667	710	790302516	1086	790305041	1086	790400120	746	790402068	748
790008668	710	790302517	1086	790305042	1086	790400122	746	790402070	748
790008669	710	790302518	1086	790305043	1086	790400124	746	790402072	748
790008670	710	790302519	1086	790305044	1086	790400126	746	790402074	748
790008671	710	790302520	1086	790305045	1086	790400128	746	790402076	748
790008672	710	790302521	1086	790305046	1086	790400130	746	790402078	748
790008673	710	790302522	1086	790305047	1086	790400132	746	790402080	748
790008674	710	790302523	1086	790305048	1086	790400134	746	790402082	748
790008675	710	790302524	1086	790305049	1086	790400136	746	790402084	748
790008676	710	790302525	1086	790305050	1086	790400138	746	790402086	748
790008677	710	790302526	1086	790305051	1086	790400140	746	790402088	748
790008678	710	790302527	1086	790305052	1086	790400142	746	790402090	748
790008679	710	790302528	1086	790305053	1086	790400144	746	790402092	748
790008680	710	790302529	1086	790305054	1086	790400146	746	790402094	748
790008681	710	790302530	1086	790305055	1086	790400148	746	790402096	748
790008682	710	790302531	1086	790305056	1086	790400150	746	790402098	748
790008683	710	790302532	1086	790305057	1086	790401002	747	790402100	748
790008684	710	790302533	1086	790305058	1086	790401004	747	790402102	748
790008685	710	790302534	1086	790305059	1086	790401006	747	790402104	748
790008686	710	790302535	1086	790305060	1086	790401008	747	790402106	748
790008687	710	790302536	1086	790305061	1086	790401010	747	790402108	748
790008688	710	790302537	1086	790305062	1086	790401012	747	790402110	748
790008689	710	790302538	1086	790305063	1086	790401014	747	790402112	748
790008690	710	790302539	1086	790305064	1086	790401016	747	790402114	748
790008691	710	790302540	1086	790305065	1086	790401018	747	790402116	748

NUMERIEKE INDEX

Order nr.	Pag.	Order nr.	Pag.	Order nr.	Pag.	Order nr.	Pag.	Order nr.	Pag.
790402118	748	790500112	745	790502038	749	790502206	749	800001455	347
790402120	748	790500114	745	790502040	749	790502208	749	800001463	347
790402122	748	790500116	745	790502042	749	790502210	749	800001471	347
790402124	748	790500118	745	790502044	749	790502212	749	800001489	347
790402126	748	790500120	745	790502046	749	790502214	749	800001497	347
790402128	748	790500122	746	790502048	749	790502216	749	800001505	347
790402130	748	790500124	746	790502050	749	790502218	749	800005498	354
790402132	748	790500126	746	790502052	749	790502220	749	800005506	354
790402134	748	790500128	746	790502054	749	790502222	749	800005514	354
790402136	750	790500130	746	790502056	749	790502224	749	800005522	354
790402138	750	790500132	746	790502058	749	790502226	749	800005530	354
790402140	750	790500134	746	790502060	749	790502228	749	800005548	354
790402142	750	790500136	746	790502062	749	790502230	749	800005555	354
790402144	750	790500138	746	790502064	749	790502232	749	800005803	363
790402146	750	790500140	746	790502066	749	790502234	749	800005811	363
790402148	750	790500142	746	790502068	749	790502236	749	800005829	363
790402150	750	790500144	746	790502070	749	790502238	749	800005837	363
790402152	750	790500146	746	790502072	749	790502240	749	800005845	363
790402154	750	790500148	746	790502074	749	790502242	749	800005852	363
790402156	750	790500150	746	790502076	749	790502244	749	800005860	363
790402158	750	790500152	746	790502078	749	790502246	749	800005878	363
790402160	750	790500154	746	790502080	749	790502248	749	800005886	363
790402162	750	790500156	746	790502082	749	790502250	749	800005894	363
790402164	750	790500158	746	790502084	749	790502252	749	800005902	363
790402166	750	790500160	746	790502086	749	790502254	749	800005910	363
790402168	750	790500162	746	790502088	749	790502256	749	800005928	363
790402170	750	790500164	746	790502090	749	790502258	749	800005969	363
790402172	750	790500166	746	790502092	749	790502260	749	800005977	363
790402174	750	790500168	746	790502094	749	790502262	749	800005985	363
790500002	744	790501002	747	790502096	749	790502264	749	800005993	363
790500004	744	790501004	747	790502098	749	790502266	749	800006009	363
790500006	744	790501006	747	790502100	749	790502268	749	800006017	363
790500008	744	790501008	747	790502102	749	790502270	750	800006025	363
790500010	744	790501010	747	790502104	749	790502272	750	800009789	352
790500012	744	790501012	747	790502106	749	790502274	750	800009797	352
790500014	744	790501014	747	790502108	749	790502276	750	800009805	352
790500016	744	790501016	747	790502110	749	790502278	750	800009813	352
790500018	744	790501018	747	790502112	749	790502280	750	800009821	352
790500020	744	790501020	747	790502114	749	790502282	750	800009839	352
790500022	744	790501022	747	790502116	749	790502284	750	800009847	352
790500024	744	790501024	747	790502118	749	790502286	750	800009888	352
790500026	744	790501026	747	790502120	749	790502288	750	800009896	352
790500028	744	790501028	747	790502122	749	790502290	750	800009904	352
790500030	744	790501030	747	790502124	749	790502292	750	800009912	352
790500032	744	790501032	747	790502126	749	790502294	750	800009920	352
790500034	744	790501034	747	790502128	749	790502296	750	800009938	352
790500036	744	790501036	747	790502130	749	790502298	750	800009946	352
790500038	744	790501038	747	790502132	749	790502300	750	800010770	229
790500040	744	790501040	747	790502134	749	790502302	750	800010780	229
790500042	744	790501042	747	790502136	749	790502304	750	800010790	229
790500044	744	790501044	747	790502138	749	790502306	750	800011389	352
790500046	744	790501046	747	790502140	749	790502308	750	800011397	352
790500048	744	790501048	747	790502142	749	790502310	750	800011405	352
790500050	744	790501050	747	790502144	749	790502312	750	800011413	352
790500052	744	790501052	747	790502146	749	790502314	750	800011421	352
790500054	744	790501054	747	790502148	749	790502316	750	800011439	352
790500056	745	790501056	747	790502150	749	790502318	750	800011447	352
790500058	745	790501058	747	790502152	749	790502320	750	800011587	352
790500060	745	790501060	747	790502154	749	790502322	750	800011595	352
790500062	745	790501062	747	790502156	749	790502324	750	800011603	352
790500064	745	790501064	747	790502158	749	790502326	750	800011611	352
790500066	745	790501066	747	790502160	749	790502328	750	800011629	352
790500068	745	790501068	747	790502162	749	790502330	750	800011637	352
790500070	745	790501070	747	790502164	749	790502332	750	800011645	352
790500072	745	790501072	747	790502166	749	790502334	750	800012783	361
790500074	745	790501074	747	790502168	749	790502336	750	800012825	317
790500076	745	790502002	748	790502170	749	790502338	750	800013880	346
790500078	745	790502004	749	790502172	749	790502340	750	800013898	346
790500080	745	790502006	749	790502174	749	790502342	750	800013906	346
790500082	745	790502008	749	790502176	749	790502344	750	800013914	346
790500084	745	790502010	749	790502178	749	790502346	750	800013922	346
790500086	745	790502012	749	790502180	749	790502348	750	800013930	346
790500088	745	790502014	749	790502182	749	790504002	752	800013948	346
790500090	745	790502016	749	790502184	749	790504004	752	800013955	346
790500092	745	790502018	749	790502186	749	790504006	752	800013963	346
790500094	745	790502020	749	790502188	749	790504022	751	800014011	346
790500096	745	790502022	749	790502190	749	790504024	751	800014268	346
790500098	745	790502024	749	790502192	749	790504026	752	800014276	346
790500100	745	790502026	749	790502194	749	790504032	751	800014284	346
790500102	745	790502028	749	790502196	749	790504034	751	800014292	346
790500104	745	790502030	749	790502198	749	790504036	751	800014300	346
790500106	745	790502032	749	790502200	749	800001422	347	800014318	346
790500108	745	790502034	749	790502202	749	800001430	347	800014326	346
790500110	745	790502036	749	790502204	749	800001448	347	800014334	346

Order nr.	Pag.	Order nr.	Pag.	Order nr.	Pag.	Order nr.	Pag.	Order nr.	Pag.
800014342	347	800020406	356	800023905	361	800043473	350	800170720	830
800015901	356	800020414	356	800024408	357	800043481	350	800170730	832
800015919	356	800020422	356	800024416	357	800043499	350	800170805	824
800015927	356	800020430	356	800024424	357	800043507	350	800170810	828
800015935	356	800020679	356	800024432	357	800043515	350	800170815	834
800015943	356	800020687	356	800024440	357	800043523	350	800170820	836
800015950	356	800020695	356	800024457	357	800043531	350	801000090	181
800015968	356	800020703	356	800024465	357	800043549	350	801007805	55
800016198	355	800020711	356	800024507	357	800043556	350	801008211	77
800016214	355	800020729	356	800024515	357	800043564	350	801008529	82
800016222	355	800020737	356	800024523	357	800043572	350	801008530	82
800016230	355	800020877	356	800024531	357	800043580	350	801008531	82
800016248	355	800020901	356	800024549	357	800043598	350	801008532	82
800016255	355	800020919	356	800024556	357	800043606	351	801008537	82
800016297	355	800020927	356	800024564	357	800043614	351	801008538	82
800016305	355	800020935	356	800025678	351	800043622	351	801008539	82
800016313	355	800020943	356	800025686	351	800043630	351	801008540	82
800016321	355	800021883	358	800025694	351	800043648	351	801008553	82
800016339	355	800021891	358	800025702	351	800043656	351	801008554	82
800016362	354	800021909	358	800025710	351	800043663	351	801008555	82
800016370	354	800021917	358	800025728	351	800043671	351	801008556	82
800016388	354	800021925	358	800025736	351	800043689	351	801008557	82
800016396	354	800021933	358	800025777	351	800043697	351	801008558	82
800016404	354	800021941	358	800025785	351	800043705	351	801008560	82
800016412	354	800021958	358	800025793	351	800043721	351	801008561	82
800016420	354	800021990	358	800025801	351	800043739	351	801008563	82
800016461	354	800022006	358	800025819	351	800043747	351	801008564	82
800016479	354	800022014	358	800025827	351	800043754	351	801008565	82
800016487	354	800022022	358	800025835	351	800043762	351	801008567	82
800016495	354	800022030	358	800035123	349	800043770	351	801008568	82
800016503	354	800022048	358	800035131	349	800043788	351	801008569	77
800016644	357	800022055	358	800035149	349	800043796	351	801008572	77
800016651	357	800022063	358	800035156	349	800043812	351	801008574	77
800016669	357	800022105	358	800035164	349	800043820	351	801008575	77
800016677	357	800022113	358	800035172	349	800043838	351	801008576	77
800016685	357	800022121	358	800035180	349	800043846	351	801008577	77
800016693	357	800022139	358	800035198	349	800043854	351	801008578	77
800016701	357	800022147	358	800035206	349	800043862	351	801008593	79
800016867	355	800022154	358	800035214	349	800043879	351	801008594	79
800016875	355	800022162	358	800035222	349	800043887	351	801008595	79
800016883	355	800022170	358	800035230	349	800043895	351	801008596	79
800016891	355	800022212	358	800035248	349	800044869	353	801008597	79
800016909	355	800022220	358	800035255	349	800044877	353	801008598	79
800016917	355	800022238	358	800035263	349	800044885	353	801008599	79
800016925	355	800022246	358	800035271	349	800044893	353	801008600	79
800016966	355	800022261	358	800035289	349	800044901	353	801008602	79
800016974	355	800022279	358	800035297	349	800044919	353	801008603	79
800016982	355	800022287	358	800035305	349	800044927	353	801008604	79
800016990	355	800022329	358	800035313	349	800044935	353	801100166	250
800017006	355	800022337	358	800035321	349	800044943	353	801100167	250
800018947	355	800022345	358	800035339	349	800044951	353	801105600	251
800018954	355	800022352	358	800035347	349	800044968	353	801105600	541
800018962	355	800022360	358	800035354	349	800044976	353	801105600	60
800018970	355	800022378	358	800035362	349	800044984	353	801105750	249
800018988	355	800022386	358	800035370	349	800044992	353	801105760	60
800018996	355	800022394	358	800035388	349	800045000	353	801105760	541
800019002	355	800022436	358	800035396	349	800045015	353	801106000	60
800019044	355	800022444	358	800035404	349	800045643	350	801106000	541
800019051	355	800022451	358	800035412	349	800045650	350	801106000	251
800019069	355	800022469	358	800036188	349	800045668	350	801106010	306
800019077	355	800022477	358	800036196	349	800045676	350	801106030	306
800019085	355	800022485	358	800036204	349	800045684	350	801106032	306
800019127	355	800022493	358	800036212	349	800045692	350	801106045	409
800019135	355	800022501	358	800036220	349	800045700	351	801106045	409
800019143	355	800023442	357	800036238	349	800045718	351	801106060	307
800019150	355	800023459	357	800036246	349	800045726	351	801200336	121
800019168	355	800023467	357	800036253	349	800045734	351	801200341	121
800019176	355	800023475	357	800036261	349	800045742	351	801200344	121
800019184	355	800023483	357	800036279	349	800045759	351	801200375	139
800019226	355	800023491	357	800043309	350	800170108	712	801200600	167
800019234	355	800023509	357	800043317	350	800170110	712	801200601	167
800019242	355	800023640	360	800043325	350	800170150	713	801200603	167
800019259	355	800023657	360	800043333	350	800170155	713	801200604	167
800019267	355	800023665	360	800043341	350	800170160	713	801200605	167
800019739	354	800023673	360	800043358	350	800170225	728	801200742	82
800019747	354	800023681	360	800043366	350	800170250	727	801200743	57
800019754	354	800023699	360	800043374	350	800170251	727	801200744	57
800019762	354	800023707	360	800043390	350	800170260	727	801200746	82
800019770	354	800023848	361	800043416	350	800170300	762	801200749	82
800019788	354	800023855	361	800043424	350	800170305	762	801200762	70
800019796	354	800023863	361	800043432	350	800170702	818	801200763	71
800020372	356	800023871	361	800043440	350	800170705	820	801200802	271
800020380	356	800023889	361	800043457	350	800170710	822	801200803	271
800020398	356	800023897	361	800043465	350	800170715	826	801200804	271

NUMERIEKE INDEX

Order nr.	Pag.	Order nr.	Pag.	Order nr.	Pag.	Order nr.	Pag.	Order nr.	Pag.
801200805	271	810004648	348	830722000	692	830801102	666	830802304	686
801200813	271	810004887	349	830722039	673	830802029	643	830802319	643
801200814	271	810004895	349	830722077	674	830802032	674	830802339	686
801200816	58	810004903	349	830722078	674	830802036	673	830802395	690
801201232	85	810004911	349	830722119	675	830802037	673	830802396	690
801201233	85	810004929	349	830722120	675	830802038	674	830802415	683
801201234	85	810004937	349	830722149	674	830802043	686	830802420	688
801201236	85	810004945	349	830722150	674	830802048	674	830802422	688
801201237	85	810004952	349	830722151	674	830802050	674	830802423	688
801201238	85	810004960	349	830722305	674	830802051	690	830802425	688
801201334	85	810004978	349	830722319	674	830802061	690	830802428	688
801201336	85	815610000	548	830722332	688	830802062	690	830802429	688
801201337	85	815610001	548	830722333	688	830802064	690	830802433	686
801202780	85	815610008	398	830722334	688	830802080	688	830802434	691
801202781	85	815610009	398	830722341	675	830802081	688	830802439	691
801202782	85	815610018	398	830722346	675	830802092	688	830802485	688
801202783	85	815610039	548	830722415	673	830802096	688	830802489	683
801202785	85	815610040	548	830722416	673	830802114	643	830802495	691
801202786	85	815610048	548	830722423	674	830802115	673	830802496	691
802000105	229	815610059	548	830722437	674	830802123	688	830802515	644
802000107	229	815610099	398	830722516	674	830802126	688	830802516	644
802000505	229	815611001	304	830722552	673	830802129	643	830802517	644
802000520	229	815611002	304	830722553	673	830802131	643	830802527	644
802104020	229	815613000	548	830722556	673	830802132	690	830802528	644
810000778	348	815613001	548	830722563	683	830802133	690	830802529	644
810000786	348	815613030	548	830722597	674	830802145	691	830802530	644
810000794	348	815613042	548	830722672	674	830802146	691	830802531	644
810000802	348	815613044	548	830722680	673	830802147	673	830802532	644
810000810	348	815613046	548	830722681	673	830802148	673	830802533	692
810000828	348	815614011	547	830722682	673	830802179	691	830802534	692
810000836	348	815614021	547	830722684	674	830802181	691	830802535	692
810000844	348	815614031	547	830722685	674	830802188	691	830802538	692
810000851	348	815614041	547	830722686	674	830802209	691	830802539	692
810001917	348	815614051	547	830722687	674	830802214	688	830802543	692
810001925	348	815614061	547	830722688	674	830802220	683	830802545	316
810001933	348	815614066	547	830722689	674	830802222	683	830802547	316
810001941	348	815614110	547	830722690	674	830802223	683	830802548	316
810001958	348	815614120	547	830722696	674	830802225	683	830802550	666
810002063	349	815614150	547	830722705	673	830802226	683	830802558	692
810002071	349	815616600	548	830722788	674	830802228	683	830802575	316
810002089	349	815616601	548	830722791	674	830802229	683	830802580	316
810002097	349	815616608	548	830722792	674	830802230	683	830802581	316
810002105	349	815616611	548	830722793	674	830802231	683	830802593	644
810002113	349	815616612	548	830722794	674	830802232	683	830802607	683
810002121	349	815616623	548	830722795	674	830802233	683	830802665	644
810002139	349	815616624	548	830722797	673	830802234	683	830802678	666
810002147	349	815616648	548	830722798	673	830802235	683	830802679	666
810002154	349	815616649	548	830722800	673	830802236	683	830802693	645
810002188	349	815617300	548	830722818	673	830802237	683	830802695	644
810002196	349	815617301	548	830722952	686	830802238	683	830802708	674
810002204	349	829000011	316	830742040	688	830802239	683	830802737	688
810002212	349	829000015	315	830742058	683	830802240	683	830802739	688
810002220	349	829000016	316	830742065	688	830802241	683	830802748	689
810002238	349	829000017	316	830742082	673	830802242	683	830802749	688
810002246	349	829000020	315	830742180	673	830802243	683	830802765	689
810002253	349	829000110	646	830742181	673	830802244	683	830803059	675
810002261	349	829000120	646	830742182	673	830802245	683	830803150	686
810002279	349	829000165	696	830742183	673	830802246	683	830803151	686
810003210	348	829000175	646	830742184	673	830802247	683	830803152	686
810003228	348	829000178	646	830742185	673	830802248	683	830803153	686
810003236	348	829000182	647	830742186	673	830802249	683	830803154	686
810003244	348	829000190	647	830742187	673	830802250	683	830803155	686
810003251	348	829000192	647	830742188	673	830802251	683	830803156	686
810003269	348	829200160	697	830742237	688	830802252	683	830803158	686
810003277	348	829300180	697	830742239	688	830802253	683	830803159	686
810003285	348	829650170	698	830742381	688	830802255	643	830803508	666
810003293	348	829650210	698	830742384	683	830802256	643	830803509	666
810003335	348	829650246	696	830742402	673	830802257	643	830807010	638
810003343	348	829650249	698	830742405	673	830802258	643	830807023	638
810003350	348	829650254	696	830742412	674	830802259	643	830807024	638
810003368	348	830121003	643	830742413	674	830802260	643	830807026	638
810003376	348	830122438	643	830742422	674	830802265	643	830807027	639
810003384	348	830122452	643	830742423	683	830802273	673	830807045	639
810003392	348	830143276	686	830742424	683	830802279	673	830807063	641
810003400	348	830143440	686	830742427	683	830802293	686	830807540	640
810003418	348	830143593	686	830742431	683	830802295	686	830807545	639
810004564	348	830322905	683	830742901	673	830802296	686	830807547	639
810004572	348	830432160	675	830801000	666	830802297	686	830807549	640
810004580	348	830445507	316	830801003	666	830802298	686	830807550	640
810004598	348	830445530	316	830801081	666	830802299	686	830807551	640
810004606	348	830445540	316	830801093	666	830802302	686	830807559	636
810004614	348	830445640	316	830801095	666	830802301	686	830807560	636
810004622	348	830445650	316	830801096	666	830802302	686	830807561	636
810004630	348	830445660	316	830801097	683	830802303	686	830807562	636

830807563	636	855085500	631	860001041	342	891023311	1063	95420204	276
830807568	636	856001000	542	860001042	342	891023312	1063	95420303	276
830809200	664	856001107	64	860001043	342	891023313	1063	95420402	276
830814095	665	856001110	542	860001044	342	891023314	1063	95440103	277
830814193	664	856001117	64	860001045	342	891023315	1063	95440200	277
830814196	665	856001120	542	860001046	342	891023316	1064	95440202	277
830815014	687	856001130	543	860001047	342	891023317	1064	95450102	277
830815038	680	856001140	63	860001048	342	891023318	1064	95450201	277
830815084	687	856001145	63	860001135	342	891023319	1064	95450300	277
830815088	687	856001150	63	860001136	342	891023320	1064	95450409	277
830815332	681	856001155	63	860001137	342	891023321	1064	95450508	277
830815476	681	856001200	542	860001138	342	891023322	1064	95450607	277
830815493	687	856001201	542	860001139	342	891023323	1064	95450706	277
830815957	679	856001210	542	860001140	342	891023324	1064	95451200	277
830816050	669	856001211	542	860001141	342	891023325	1065	95451400	277
830816051	670	856001300	542	860001142	342	891023326	1065	95451600	277
830816052	671	856001301	542	860001143	342	891023327	1065	95451800	277
830816053	672	856001310	542	860001144	342	891023328	1065	95452000	277
830816202	662	856001312	543	860001145	342	891023329	1065	95480109	277
830816203	662	856001313	543	860001146	342	891023330	1065	95640108	277
830816204	662	856001325	540	860001147	342	891023331	1065	96020300	403
830816211	663	856001326	538	860001148	342	891023332	1066	96020706	403
830816212	663	856001327	538	860001240	341	891023333	1066	96020904	403
830821011	676	856001328	539	860001241	341	891023334	1066	96090105	278
830821012	677	856001342	538	860001242	341	891023335	1066	96130109	278
830821052	667	856001345	541	860001243	341	891023336	1066	96140108	278
830821054	668	856001346	541	860001244	341	891023337	1066	96150107	278
830821055	668	856001347	541	860001245	341	891023338	1066	96150206	278
830821056	668	856001350	541	860001246	341	891024558	1107	96150305	278
830823000	685	856001351	538	860001247	341	891565123	409	96150404	278
830823015	684	856001356	61	860001340	341	891565382	1077	96230107	279
830823016	684	856001357	61	860001341	341	891565383	1077	96230206	279
830823017	684	856001360	536	860001342	341	891565384	1077	96230305	279
830823252	685	856001361	537	860001343	341	891566239	1107	96640107	276
830829034	637	856001364	536	860001344	341	891566736	1062	96640206	276
830829327	637	856001365	537	860001345	341	891567290	316	96640305	276
830829382	641	856001366	537	860001346	341	909061000	539	96640404	276
830829383	641	856001367	537	860001347	341	909061000	1041	96760103	277
830829384	641	856001370	536	860001838	341	909061250	1041	97170104	283
830829440	645	856001371	536	860001839	341	909061250	539	97170203	283
830829444	645	856001374	536	860001840	341	909061500	1041	97390108	271
830829446	645	856001375	536	860001841	341	909061500	539	97390207	271
830829447	645	856001392	541	860001842	341	909061750	539	97541007	268
830829512	642	856001504	539	860001843	341	909061750	1041	998140005	414
830829516	642	856001505	539	860001844	341	909070750	539	998140007	414
830829517	642	856001507	539	860001845	341	909070750	1041	998140013	414
830829558	643	856001551	539	860001846	341	909071000	1041	998140030	414
830829560	643	860000038	340	860001847	341	909071000	539	998140032	414
830835010	685	860000039	340	860001938	341	909071250	1041	99960106	203
830850000	682	860000040	340	860001939	341	909071250	539	99960155	201
830980320	683	860000041	340	860001940	341	909071500	1041	99960171	201
84270107	269	860000042	340	860001941	341	909071500	539	99960205	203
84270206	269	860000043	340	860001942	341	909072000	1041	99960304	203
84270305	269	860000044	340	860001943	341	909072000	539	99960502	203
84270404	269	860000045	340	860001944	341	909072500	539		
84270503	269	860000046	340	860001945	341	909072500	1041		
84270602	269	860000047	340	860001946	341	909075143	1041		
845002000	658	860000338	342	860001947	341	909075143	539		
850001001	317	860000339	342	861001838	340	909075144	1041		
850001003	317	860000340	342	861001839	340	909075144	539		
850001004	317	860000341	342	861001840	340	909075145	1041		
850001005	317	860000342	342	861001841	340	909075145	539		
850001006	317	860000343	342	861001842	340	909075146	1041		
850001010	317	860000344	342	861001843	340	909075146	539		
850001011	317	860000345	342	861001844	340	909075147	1041		
850001012	317	860000346	342	861001845	340	909075147	539		
850001501	318	860000347	342	861001846	340	909079100	1041		
850001502	318	860000348	342	861001847	340	909079100	539		
850003008	362	860000438	342	86970100	202	909079125	1041		
850003009	362	860000439	342	87499101	276	909079125	539		
850003011	425	860000440	342	87499102	276	909079150	539		
85140101	263	860000441	342	87499103	276	909079150	1041		
855006908	87	860000442	342	87620050	274	940001010	398		
855006913	88	860000443	342	891002489	1107	940001239	395		
855006916	153	860000444	342	891006016	1106	940014014	398		
855006916	86	860000445	342	891020430	1026	940014015	398		
855006917	89	860000446	342	891023303	1062	940014016	398		
855006919	86	860000447	342	891023304	1062	940014017	398		
855006950	90	860001035	342	891023305	1062	940014354	60		
855082000	629	860001036	342	891023306	1062	95380101	276		
855082210	630	860001037	342	891023307	1062	95380200	276		
855083000	631	860001038	342	891023308	1062	95380309	276		
855083050	629	860001039	342	891023309	1063	95380408	276		
855084000	630	860001040	342	891023310	1063	95420105	276		

Gereedschappen die de test doorstaan met vlag en wimpel!

Van motor race en zeilteams tot booreilanden en overheidsinstellingen; Teng Tools maakt er een gewoonte van te werken met winnaars. Teng Tools krijgt de voorkeur bij industriële kopers overal ter wereld. Grote autoconstructeurs en ook kleinere productiebedrijven vertrouwen op Teng Tools, Teng Tools is blij de smaak van de overwinning met hen te delen.

Arbeiders en race teams met hoge verwachtingen onderwerpen de Teng Tools producten aan alle mogelijke omstandigheden.

En ze blijven winnen, dus Teng Tools moet wel de juiste aanpak hebben.



Werken met Winnaars



Gereedschapskoffers & -wagens

METALWORKS



SOP430

SOP430

Veiligheidskoffer. Waterbestendig, schokbestendig en stofvrij. Lichaam in stevig PP. Mousse afdichting in het deksel. De opbergruimte van de koffer is opgevuld met vooruitgesneden mousse en biedt u de mogelijkheid om degewenste vorm uit te snijden. RVS scharnieren. Hoogwaardige afdichtingsring in het deksel tegen water en stof. Koffer wordt luchtdicht afgesloten dankzij een speciale afsluitknop. Mogelijkheid tot afsluiten met hangslot (niet inbegrepen).

Order nr.	758136210 €	758136330 €
Orig. nr.	SOP210	SOP330
Maximum gewicht	kg 10	18
Binnenafmetingen (l x b x h)	mm 190x130x75	300x220x90
Gewicht	kg 0,65	1,70
Afmetingen (l x b x h)	mm 210 x 170 x 90	330 x 280 x 120
Prijs	€ 25,50	49,90

Order nr.	758136430 €	758136515 €
Orig. nr.	SOP430	SOP515
Maximum gewicht	kg 25	32
Binnenafmetingen (l x b x h)	mm 395x320x125	485x355x170
Gewicht	kg 3,10	4,30
Afmetingen (l x b x h)	mm 430 x 380 x 155	515 x 415 x 200
Prijs	€ 79,00	109,00

METALWORKS



SOW410

SOW560

SOW530

OP WIELEN

Veiligheidskoffer op wielen. Regenbestendig, schokbestendig en stofvrij. Lichaam in stevig PP. De opbergruimte van de koffer is opgevuld met vooruitgesneden mousse en biedt u de mogelijkheid om degewenste vorm uit te snijden. RVS scharnieren. Hoogwaardige afdichtingsring in het deksel beschermt tegen water en stof. Koffer wordt luchtdicht afgesloten dankzij een speciale afsluitknop. Mogelijkheid tot afsluiten met hangslot (niet inbegrepen).

Order nr.	758136518 €	758136522 €	758136526 €
Orig. nr.	SOW410	SOW560	SOW530
Maximum gewicht	kg 32	32	40
Binnenafmetingen (l x b x h)	mm 430x345x170	500x285x170	510x290x252
Gewicht	kg 4,30	4,30	5,60
Afmetingen (l x b x h)	mm 475 x 410 x 190	560 x 350 x 190	530 x 355 x 290
Prijs	€ 148,00	148,00	199,00

TENGTTOOLS



Kunststof opberglade. Met aluminium hendel. Rubbermat onderaan in de lade en rubber anti-slip voetjes. Kan gebruikt worden in de Teng koffers. Ideaal om een weinig materiaal ter plaatse mee te nemen.

Order nr.	117570101 T
Orig. nr.	TCA05
Gewicht	kg 0,50
Afmetingen (l x b x h)	mm 476 x 202 x 80
Prijs	€ 18,50

TENGTTOOLS



Stalen gereedschapskoffer. Dikte staalplaat 0.9mm. Afsluitbaar met 2 bovenaan dichtklappende deksels. Stevige koffer met een pianoscharnier over de volledige lengte van het deksel. Afsluitbaar. Met uitneembaar inlegbakje.

Order nr.	117150102 T
Orig. nr.	TC414
Gewicht	kg 3,20
Afmetingen (l x b x h)	mm 355 x 205 x 180
Prijs	€ 27,90

METALWORKS



5-delige stalen gereedschapskoffer L. 430mm. Dikte staalplaat 0,6mm. Afsluitbaar. Met hangslot (niet inbegrepen).

Order nr.	728601001 T
Orig. nr.	TALGK430
Gewicht	kg 4,00
Afmetingen (l x b x h)	mm 430 x 200 x 185
Prijs	€ 33,50

METALWORKS



5-delige stalen gereedschapskoffer L. 530mm. Dikte staalplaat 0.6mm. Afsluitbaar. Met hangslot (niet inbegrepen).

Order nr.	728600530 T
Orig. nr.	TC530
Gewicht	kg 5,10
Afmetingen (l x b x h)	mm 530 x 200 x 200
Prijs	€ 31,50

TENGOOLS



HEAVY DUTY

5-delige stalen gereedschapskoffer. L. 560mm. Dikte staalplaat 0.9mm. Professionele stevige koffer met een pianoscharnier over de volledige lengte van het deksel. Afsluitbaar. Met hangslot (niet inbegrepen).

Order nr.	112440102		
Orig. nr.	TC422		
Gewicht	kg	7,00	
Afmetingen (l x b x h)	mm	560 x 205 x 205	
Prijs	€	49,90	

METAL WORKBOX

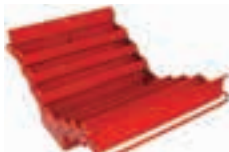

7-delige stalen gereedschapskoffer. L. 530mm. Dikte staalplaat 0.6mm. Met hangslot (niet inbegrepen).

Order nr.	112440203		
Orig. nr.	TC427		
Gewicht	kg	5,00	
Afmetingen (l x b x h)	mm	530 x 200 x 250	
Prijs	€	41,50	

TENGOOLS



Mecca Rosso toolbox. Met 2 openklapbare zijkantten. Geleverd met mat onderaan, opberglade, 2 uitneembare alu-rails L. 430mm, 3x30 dopclips 1/4", 3/8" en 1/2".

Order nr.	35880202		
Orig. nr.	TC450		
Gewicht	kg	5,50	
Afmetingen (l x b x h)	mm	450 x 200 x 200	
Prijs	€	69,90	

TENGOOLS



Gereedschapstas in polyester. Kan gebruikt worden als rugzak.

Order nr.	173150103		
Orig. nr.	TCSB		
Gewicht	kg	1,29	
Afmetingen (l x b x h)	mm	380 x 230 x 430	
Prijs	€	61,00	

TENGOOLS



Gereedschapstas in polyester. Met metalen draaghandvat en schouderband. In het onderste compartiment passen 3 TC-trays.

Order nr.	173150202	173150301
Orig. nr.	TCSB16	TCSB20
Gewicht	kg 2,98	4,30
Afmetingen (l x b x h)	mm 410 x 280 x 300	520 x 280 x 365
Prijs	€ 68,00	99,00

TENGOOLS



Lege service case. Numerisch slot. Geschikt voor 3x3 Teng tools TC trays. Op rubberen wielen. Met stevig uitschuifbaar handvat en 2 draaghandvaten.

Order nr.	144070109		
Orig. nr.	TC-SC		
Gewicht	kg	6,40	
Afmetingen (l x b x h)	mm	527 x 385 x 197	
Prijs	€	215,00	

TENGOOLS



Kunststof opbergkoffer. Geschikt voor 3 Teng Tools Tc trays.

Order nr.	114640105		
Orig. nr.	TC-3		
Gewicht	kg	1,40	
Afmetingen (l x b x h)	mm	470 x 320 x 65	
Prijs	€	21,50	



TENGOOLS



Gereedschapskoffer met 3 afsluitbare rolgelagerde lades. Geleverd met een EVA-rubber mat op de bovenkant als tussenmat indien de koffer wordt gebruikt samen met een topbox. Slot met 2 sleutels. Iedere lade is geschikt voor 3 TC trays.

Order nr.	166820100		
Orig. nr.	TC803SV		
Aantal lades	3		
Afmetingen middelgrote lade	mm	572x270x50 (x2)	
Afmetingen grote lade	mm	572x270x75 (x1)	
Maximum gewicht per lade	kg	20	
Gewicht	kg	13,80	
Afmetingen (l x b x h)	mm	660 x 305 x 250	
Prijs	€	134,00	

TENGOOLS



Gereedschapskoffer Serie 8 met 3 afsluitbare rolgelagerde lades. Geleverd met een EVA-rubber mat op de bovenkant als tussenmat indien de koffer wordt gebruikt samen met een topbox. Met numerisch slot. Iedere lade is geschikt voor 3 TC trays.

Order nr.	122360100		
Orig. nr.	TC803N		
Aantal lades	3		
Afmetingen middelgrote lade	mm	572x270x50 (x12)	
Afmetingen grote lade	mm	572x270x75 (x1)	
Maximum gewicht per lade	kg	20	
Gewicht	kg	13,80	
Afmetingen (l x b x h)	mm	660 x 305 x 250	
Prijs	€	169,00	

TENGOOLS



Gereedschapskoffer Serie 8 met 3 afsluitbare rolgelagerde lades. Grijs-metaalkleurige afwerking. Geleverd met een EVA-rubber mat op de bovenkant als tussenmat indien de koffer wordt gebruikt samen met de topbox TC804NS. Iedere lade is geschikt voor 4 TC trays. Sleutelslot.

Order nr.	139610109		
Orig. nr.	TC803NS		
Aantal lades	3		
Afmetingen middelgrote lade	mm	572x270x50 (x2)	
Afmetingen grote lade	mm	572x270x75 (x1)	
Maximum gewicht per lade	kg	20	
Gewicht	kg	13,80	
Afmetingen (l x b x h)	mm	660 x 305 x 250	
Prijs	€	169,00	

TENGOOLS



Gereedschapskoffer Serie 8 met 4 afsluitbare rolgelagerde lades. Met cijferslot.

Order nr.	122370109		
Orig. nr.	TC804N		
Aantal lades	4		
Afmetingen middelgrote lade	mm	572x270x50 (x3)	
Afmetingen grote lade	mm	572x270x75 (x1)	
Maximum gewicht per lade	kg	20	
Gewicht	kg	21,00	
Afmetingen (l x b x h)	mm	660 x 305 x 380	
Prijs	€	219,00	

TENGOOLS



Gereedschapskoffer Serie 8 met 4 afsluitbare rolgelagerde lades. Grijs-metaalkleurige afwerking. Iedere lade is geschikt voor 4 TC trays. Sleutelslot.

Order nr.	143790103		
Orig. nr.	TC804NS		
Aantal lades	4		
Afmetingen middelgrote lade	mm	572x270x50 (x3)	
Afmetingen grote lade	mm	572x270x75 (x1)	
Maximum gewicht per lade	kg	20	
Gewicht	kg	21,00	
Afmetingen (l x b x h)	mm	660 x 305 x 380	
Prijs	€	219,00	



TENGOOLS



Gereedschapskoffer met 6 rolgelagerde lades. Met een afsluitbaar deksel dat alle lades bedekt eenmaal de koffer gesloten is. Twee stevige handvaten aan de zijkanten. Slot met twee sleutels.

Order nr.	162620108
Orig. nr.	TC806SV
Aantal lades	6
Afmetingen kleine lade	mm 170x275x50 (x3)
Afmetingen middelgrote lade	mm 569x275x50 (x2)
Afmetingen grote lade	mm 569x275x75 (x1)
Maximum gewicht per lade	kg 20
Gewicht	kg 23,40
Afmetingen (l x b x h)	mm 660 x 307 x 374
Prijs	€ 205,00

TENGOOLS



Gereedschapskoffer Serie 8 met 6 rolgelagerde lades. Met een afsluitbaar deksel dat alle lades bedekt eenmaal de koffer gesloten is. Twee stevige handvaten aan de zijkanten. Met cijferslot.

Order nr.	122160104
Orig. nr.	TC806NF
Aantal lades	6
Afmetingen kleine lade	mm 170x275x50 (x3)
Afmetingen middelgrote lade	mm 569x275x50 (x2)
Afmetingen grote lade	mm 569x275x75 (x1)
Maximum gewicht per lade	kg 20
Gewicht	kg 23,40
Afmetingen (l x b x h)	mm 305 x 660 x 380
Prijs	€ 265,00

TENGOOLS



Gereedschapskoffer Serie 8 met 6 rolgelagerde lades. Met een afsluitbaar deksel dat alle lades bedekt eenmaal de koffer gesloten is. Twee stevige handvaten aan de zijkanten. Speciale oranje KTM uitvoering. Sleutelslot.

Order nr.	801007805
Orig. nr.	TC806NO
Aantal lades	6
Afmetingen kleine lade	mm 170x275x50 (x3)
Afmetingen middelgrote lade	mm 569x275x50 (x2)
Afmetingen grote lade	mm 569x275x75 (x1)
Maximum gewicht per lade	kg 20
Gewicht	kg 22,00
Afmetingen (l x b x h)	mm 660 x 305 x 380
Prijs	€ 265,00

TENGOOLS



Gereedschapskoffer Serie 8 met 5 afsluitbare rolgelagerde lades. Maximum gewicht per lade 20kg. Diepe uitvoering: 1 lade kan 4 TC-Trays + 1 TTX-Tray bevatten. Met een afsluitbaar deksel dat alle lades bedekt eenmaal de koffer gesloten is. Twee stevige handvaten aan de zijkanten. Met cijferslot.

Order nr.	122190101
Orig. nr.	TC805NFX
Aantal lades	5
Afmetingen middelgrote lade	mm 576x410x50 (x2)
Afmetingen grote lade	mm 576x410x75 (x3)
Maximum gewicht per lade	kg 20
Gewicht	kg 44,00
Afmetingen (l x b x h)	mm 660 x 455 x 490
Prijs	€ 479,00

TENGOOLS



Gereedschapswagen Serie 8 met 3 afsluitbare rolgelagerde lades en 1 afsluitbare kast. Met 2 cijfersloten. 2 vaste wielen, 2 draaibare met rem.

Order nr.	03450103
Orig. nr.	TCW803N
Aantal lades	3
Afmetingen middelgrote lade	mm 575x380x75 (x2)
Afmetingen grote lade	mm 575x380x150 (x1)
Maximum gewicht per lade	kg 25
Gewicht	kg 43,40
Afmetingen (l x b x h)	mm 670 x 460 x 760
Prijs	€ 444,00

TENGOOLS



Gereedschapswagen Serie 8. Met 6 afsluitbare rolgelagerde lades. Met cijferslot. 2 vaste wielen, 2 draaibare met rem.

Order nr.	122170103
Orig. nr.	TCW806N
Aantal lades	6
Afmetingen middelgrote lade	mm 575x380x75 (x5)
Afmetingen grote lade	mm 575x380x150 (x1)
Maximum gewicht per lade	kg 25
Gewicht	kg 59,00
Afmetingen (l x b x h)	mm 670 x 460 x 780
Prijs	€ 489,00

TENGOOLS



Gereedschapswagen Serie 8. Met 4 afsluitbare rolgelagerde lades. Met cijferslot. 2 vaste wielen, 2 draaibare met rem.

Order nr.	161640107
Orig. nr.	TCW804N
Aantal lades	4
Afmetingen middelgrote lade	mm 576x380x75 (x3)
Afmetingen grote lade	mm 576x380x312 (x1)
Maximum gewicht per lade	kg 25
Gewicht	kg 49,00
Afmetingen (l x b x h)	mm 670 x 460 x 812
Prijs	€ 431,00

TENGOOLS



Gereedschapswagen Serie 8. Met 6 afsluitbare rolgelagerde lades. Met cijferslot. 2 vaste wielen, 2 draaibare met rem.

Order nr.	161630108
Orig. nr.	TCW806N1
Aantal lades	6
Afmetingen middelgrote lade	mm 576x380x75 (x5)
Afmetingen grote lade	mm 576x380x312 (x1)
Maximum gewicht per lade	kg 25
Gewicht	kg 61,20
Afmetingen (l x b x h)	mm 670 x 460 x 960
Prijs	€ 525,00

TENGOOLS



Gereedschapswagen Serie 8 met 7 afsluitbare rolgelagerde lades. Met sleutelslot. 2 vaste wielen, 2 draaibare met rem.

Order nr.	162630107
Orig. nr.	TCW807SV
Aantal laden	7
Afmetingen middelgrote lade	mm 575x380x75 (x5)
Afmetingen grote lade	mm 575x380x150 (x2)
Maximum gewicht per lade	kg 25
Gewicht	kg 61,00
Afmetingen (l x b x h)	mm 670 x 460 x 950
Prijs	€ 449,00

TENGOOLS



Gereedschapswagen Serie 8 met 7 afsluitbare rolgelagerde lades. Grijs-metaalkleurige afwerking. Met cijferslot. 2 vaste wielen, 2 draaibare met rem.

Order nr.	801200743
Orig. nr.	TCW807NS
Aantal laden	7
Afmetingen middelgrote lade	mm 575x380x75 (x5)
Afmetingen grote lade	mm 575x380x150 (x2)
Maximum gewicht per lade	kg 25
Gewicht	kg 64,00
Afmetingen (l x b x h)	mm 670 x 460 x 950
Prijs	€ 549,00

TENGOOLS



Gereedschapswagen Serie 8 met 7 afsluitbare rolgelagerde lades. Met cijferslot. 2 vaste wielen, 2 draaibare met rem.

Order nr.	122180102
Orig. nr.	TCW807N
Aantal laden	7
Afmetingen middelgrote lade	mm 575x380x75 (x5)
Afmetingen grote lade	mm 575x380x150 (x2)
Maximum gewicht per lade	kg 25
Gewicht	kg 64,00
Afmetingen (l x b x h)	mm 670 x 460 x 950
Prijs	€ 539,00

TENGOOLS



Gereedschapswagen Serie 8. Met 7 afsluitbare rolgelagerde lades. Oranje KTM uitvoering. Met cijferslot. 2 vaste wielen, 2 draaibare met rem.

Order nr.	801200744
Orig. nr.	TCW807NO
Aantal laden	7
Afmetingen middelgrote lade	mm 575x380x75 (x5)
Afmetingen grote lade	mm 575x380x150 (x2)
Maximum gewicht per lade	kg 25
Gewicht	kg 64,00
Afmetingen (l x b x h)	mm 670 x 460 x 950
Prijs	€ 549,00

TENGOOLS



Gereedschapswagen Serie 8. Met 8 afsluitbare rolgelagerde lades. Met cijferslot. 2 vaste wielen, 2 draaibare met rem.

Order nr.	128730108
Orig. nr.	TCW808N
Aantal lades	8
Afmetingen middelgrote lade	mm 575x380x75 (x7)
Afmetingen grote lade	mm 575x380x154 (x1)
Maximum gewicht per lade	kg 25
Gewicht	kg 61,00
Afmetingen (l x b x h)	mm 670 x 460 x 950
Prijs	€ 589,00

TENGOOLS



Gereedschapswagen Serie 8 met 10 afsluitbare rolgelagerde lades. Met cijferslot. 2 vaste wielen, 2 draaibare met rem.

Order nr.	122380108
Orig. nr.	TCW810N
Aantal lades	10
Afmetingen kleine lade	mm 575x380x50 (x6)
Afmetingen middelgrote lade	mm 575x380x75 (x3)
Afmetingen grote lade	mm 575x380x150 (x1)
Maximum gewicht per lade	kg 25
Gewicht	kg 68,50
Afmetingen (l x b x h)	mm 670 x 460 x 950
Prijs	€ 625,00

TENGOOLS



Combinatie van TC806SV + TC803SV + TCW807SV. 2 vaste wielen, 2 draaibare met rem.

Order nr.	801200816
Orig. nr.	TCW816SV
Aantal lades	16
Gewicht	kg 97,00
Afmetingen (l x b x h)	mm 670 x 460 x 1575
Prijs	€ 769,00

TENGOOLS



Gereedschapskoffer met 4 afsluitbare rolgelagerde lades. Twee stevige handvaten aan de zijkanen. Met cijferslot.

Order nr.	167440106
Orig. nr.	TC8041N
Aantal lades	4
Afmetingen middelgrote lade	mm 1216x380x65 (x3)
Afmetingen grote lade	mm 1216x380x100 (x1)
Maximum gewicht per lade	kg 40
Gewicht	kg 67,00
Afmetingen (l x b x h)	mm 1340 x 457 x 440
Prijs	€ 779,00

TENGOOLS



Brede gereedschapswagen serie 8 met 6 afsluitbare rolgelagere lades. Met houten topblad. Gepatenteerd systeem waarbij max. 1 lade met een keer kan geopend worden. Lades met versterking. Met cijferslot. Max. gewicht bij gelijke verdeling over de lade.

Order nr.	151340106		
Orig. nr.	TCW806LN		
Aantal lades	6		
Afmetingen kleine lade	mm	1216x380x65 (x3)	
Afmetingen middelgrote lade	mm	1216x380x100 (x1)	
Afmetingen grote lade	mm	1216x380x154 (x2)	
Maximum gewicht per lade	kg	60-40-50	
Gewicht	kg	121,00	
Afmetingen (l x b x h)	mm	1350 x 460 x 950	
Prijs	€	1.299,00	

TENGOOLS



Brede gereedschapswagen serie 8 met 9 afsluitbare rolgelagere lades waarvan 1 super grote dubbele lade cap. 40kg. Met een houten topblad. Met cijferslot. Max. gewicht bij gelijke verdeling lade.

Order nr.	151350105		
Orig. nr.	TCW809N		
Aantal lades	9		
Afmetingen kleine lade	mm	576x380x75 (x6)	
Afmetingen middelgrote lade	mm	576x380x154 (x2)	
Afmetingen grote lade	mm	1216x380x124 (x1)	
Maximum gewicht per lade	kg	40-25-25	
Gewicht	kg	136,00	
Afmetingen (l x b x h)	mm	1350 x 460 x 950	
Prijs	€	1.415,00	

Accessoires

TENGOOLS



Side kast voor gereedschapswagens Teng Tools.

Order nr.	174670109	174680108	174690107
Orig. nr.	TCW-CAB01	TCW-CAB02	TCW-CAB03
Gewicht	kg 40,50	29,00	22,60
Afmetingen (l x b x h)	mm 382 x 460 x 795	382 x 460 x 795	382 x 460 x 795
Prijs	€ 419,00	287,00	204,00

TENGOOLS



Afsluitbare kast om aan de zijkant van de gereedschapswagen te bevestigen. Bevestigingsmoeren en plank worden meegeleverd.

Order nr.	112550108		
Orig. nr.	TCW-CAB		
Gewicht	kg 6,50		
Afmetingen (l x b x h)	mm 400 x 200 x 500		
Prijs	€ 75,00		

TENGOOLS



Afsluitbare kast. Te gebruiken als muurkast of te plaatsen bovenop de Teng Tools gereedschapswagens. TCB80 past ook op de tussenkoffers met cijferslot.

Order nr.	174660100	174660209
Orig. nr.	TCB80	TCB80A
Gewicht	kg 15,00	16,50
Afmetingen (l x b x h)	mm 660 x 305 x 600	660 x 455 x 600
Prijs	€ 287,00	342,00

TENGOOLS



Zijtafel- en papierhouder. Geschikt om te bevestigen aan de zijkant van een Teng Tools gereedschapswagen.

Order nr.	117560102		
Orig. nr.	TCA01		
Dimensions table	mm 370x370		
Gewicht	kg 6,00		
Prijs	€ 95,00		

TENGTTOOLS



Roestvrijstalen schotel met 1 ronde magneet ingebouwd aan de onderkant. Deze onderkant is voorzien van een beschermende laag om schade aan bv. het wagenoppervlak te vermijden. Een prima werkinstrument om kleine zaken zoals schroeven, bouten, moeren e.d. samen te houden. Kan ook omgekeerd en zijdelings worden gebruikt. Rond model diam. 150mm.

Order nr.	15610108	
Orig. nr.	580	
Diameter	mm	150
Gewicht	kg	0,38
Afmetingen (l x b x h)	mm	157 x 42 x 157
Prijs	€	13,90

TENGTTOOLS



Roestvrijstalen schotel met 2 ronde magneten ingebouwd aan de onderkant. Deze onderkant is voorzien van een beschermende laag om schade aan bv. het wagenoppervlak te vermijden. Een prima werkinstrument om kleine zaken zoals schroeven, bouten, moeren e.d. samen te houden. Kan ook omgekeerd en zijdelings worden gebruikt. Rechthoekig model 320x150mm.

Order nr.	118470103	
Orig. nr.	580A	
Gewicht	kg	0,87
Afmetingen (l x b x h)	mm	325 x 150 x 70
Prijs	€	27,90

TENGTTOOLS

NEW



Vierkante magnetische schotel 295x270mm. Grote magnetische roestvrijstalen schotel met 4 magneten met kunststof bedekt om de lak van de wagen niet te beschadigen.

Order nr.	186870101	
Orig. nr.	580S	
Gewicht	kg	1,00
Afmetingen (l x b x h)	mm	295 x 270 x 42
Prijs	€	37,90

TENGTTOOLS



Bakje met magnetische bevestiging. Voor plaatsing aan de zijkant van bv. een gereedschapswagen of paneel.

Order nr.	117880104	117880203
Orig. nr.	580C	580D
Gewicht	kg 0,96	0,69
Afmetingen (l x b x h)	mm 310 x 115 x 30	210 x 115 x 30
Prijs	€ 31,90	26,50

METAL WORKS



Magneetbaar lengte 600mm. Perfect om uw stalen gereedschappen aan te hangen. Kan aan elke magnetische achtergrond worden bevestigd, alsook via 2 bevestigingshaken. Capaciteit 10kg per 3cm. Afmetingen 610x20x15mm.

Order nr.	801105600	
Orig. nr.	MAG600A	
Lengte	mm	600
Gewicht	kg	1,60
Prijs	€	12,50

METAL WORKS



Multifunctionele magnetische rail om ijzeren en stalen gereedschappen op te hangen. Kan magnetisch bevestigd worden aan een metalen achterwand zoals een werkbank of perfopaneel. Afmetingen 610x20x15mm. Capaciteit 2000 Gauss.

Order nr.	801106000	
Orig. nr.	MAG600	
Gewicht	kg	1,54
Prijs	€	12,50

METAL WORKS

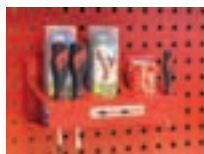

Spruitbushouder met magneetbevestiging. Kan op elke metalen ondergrond worden bevestigd.

Order nr.	801105760	
Orig. nr.	MAG3CAN	
Gewicht	kg	1,19
Afmetingen (l x b x h)	mm	127 x 298 x 130
Prijs	€	14,50

TENGTTOOLS



Magnetische spuitbushouder.

Order nr.	160730107	
Orig. nr.	580J	
Gewicht	kg	2,11
Afmetingen (l x b x h)	mm	410 x 90 x 100
Prijs	€	39,90

VC



NEW

Siliconehouder 3100mm.

Order nr.	940014354	
Orig. nr.	PTSIL/31	
Gewicht	kg	0,78
Prijs	€	39,00



TENGOOLS

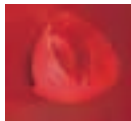

PVC kom met een sterke magneet voor bevestiging aan gereedschapswagens, gereedschap paneel, ...

Order nr.	174610204	
Orig. nr.	580R	
Diameter	mm	150
Afmetingen (l x b x h)	mm	160 x 150 x 130
Prijs	€	15,90

TENGOOLS



Zijtafel voor Teng Tools gereedschapswagens.

Order nr.	186250106	
Orig. nr.	TCA02	
Afmetingen (l x b x h)	mm	455 x 300 x 0
Prijs	€	49,90

TENGOOLS



Plastieken beschermingsmat met magnetische strips. Gebruikt ter bescherming van het koetswerk bij het herstellen van de wagen.

Order nr.	109480103	
Orig. nr.	FC01	
Afmetingen (l x b x h)	mm	1070 x 25 x 400
Prijs	€	48,90

TENGOOLS

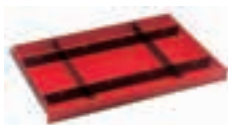

Set om compartimenten te creëren voor de lades van de Teng gereedschapswagens. Bestaande uit 2 latten van 570x40x3mm en 2 latten van 375x40x3mm.

Order nr.	122250103	
Orig. nr.	TCDIVL	
Afmetingen (l x b x h)	mm	570 x 40 x 3
Prijs	€	6,10

TENGOOLS



Set om compartimenten te creëren voor de lades van de Teng top en tussen koffers. Bestaat uit 2 latten van 570x40x3mm en 2 latten van 272x40x3mm.

Order nr.	122240104	
Orig. nr.	TCDIVS	
Afmetingen (l x b x h)	mm	570 x 40 x 3
Prijs	€	6,10

TENGOOLS



ABS-plaat. Voor plaatsing op de bovenkant van de Teng gereedschapswagens als bescherming. Voorzien van 8 kleine compartimenteringen.

Order nr.	112540109	
Orig. nr.	ABSTOP	
Afmetingen (l x b x h)	mm	670 x 460 x 0
Prijs	€	31,50

METALWORKS



Werkblad multiplex TT. Geschikt voor plaatsing op uw teng tools materiaal kar. Schokbestendige en stevige bescherming van uw bovenblad.

Order nr.	856001356	856001357
Orig. nr.	TTMP660	TTMP1340
Gewicht	kg 12,00	24,00
Afmetingen (l x b x h)	mm 660 x 453 x 30	1340 x 453 x 30
Prijs	€ 44,00	84,50

TENGOOLS



Paneel met perforaties. Voor bevestiging van de Teng haken. Formaat past op alle zijanten van de Teng Serie 7 en 8 gereedschapswagens. Voorzien van een uitvouwbare voet om het paneel op zich alleen te gebruiken.

Order nr.	69940104	
Orig. nr.	TCWSP	
Gewicht	kg 6,72	
Prijs	€	61,50

TENGOOLS



Haken voor montage op het TCW-SP paneel en Teng-werkbankpaneel. Verpakt per 10 st.

Order nr.	Orig. nr.	Omschrijving	Prijs €
69940252	TCW-HK02	dubbele haken	17,50
69940203	TCWHK10	haken 3x45° - 7x90°	19,00
69940278	TCW-HK20	haken 4x45° enkel - 4x45° dubbel 4x90° enkel - 4 kleine clips - 4 grote clips	33,90
69940302	TCW-HK45	haken 10x45°	20,50
69940401	TCW-HK90	haken 10x90°	20,50
69940500	TCWHKAIR	haken voor pneumatisch gereedschap	13,50
69940609	TCW-HKB	haken voor grote clips	20,50
69940708	TCW-HKS	haken voor kleine clips	21,90

Gereedschapskoffers & -wagens

TENGOOLS



Aluminium rail. Geschikt voor gebruik met clips om doppen van 1/4", 3/8" of 1/2" op te bevestigen. Geleverd zonder dopclips.

Order nr.	28930105	28930154	28930170
Orig. nr.	ALU430	ALU1000-1	ALU1000-4
Lengte	mm 430	1000	1000
Rijen voor clipsbevestiging	1	1	4
Afmetingen (l x b x h)	mm 5 x 37 x 445	4 x 20 x 1000	
Prijs	€ 6,00	12,50	24,50

TENGOOLS



Dopclips voor aluminium rail ALU430x1000. Geschikt voor bevestiging van doppen op de hiervoor bestemde rail.

Order nr.	28930204	28930303	28930402
Orig. nr.	ALU14	ALU38	ALU12
Aansluiting	inch 1/4	3/8	1/2
Afmetingen (l x b x h)	mm 140 x 75 x 5	140 x 75 x 5	140 x 75 x 5
Prijs	€ 3,40	3,40	3,40

TENGOOLS



Set van 2 draaibare wielen. Diam 100mm. Geschikt voor de Teng wagens met 3, 5 en 6 lades (bvb. TCW806N) wanneer men de wagens wenst uit te rusten met 4 draaibare wielen om de wagen mobieler te maken.

Order nr.	112660105
Orig. nr.	TCW-SW
Diameter wiel	mm 100
Maximum gewicht per wiel	kg 80
Prijs	€ 54,50

TENGOOLS



Universele rubber mat. Kan versneden worden om bvb in de lade van een gereedschapskoffer of - wagen te worden gelegd.

Order nr.	62460100
Orig. nr.	TCMAT
Afmetingen (l x b x h)	mm 2000 x 450 x 2
Prijs	€ 19,50

METALWORKS



Geribde rubbermat op rol. Dikte 3mm. Gebruikt ter bescherming van vb. lades. Diverse toepassingsmogelijkheden. Op rol van 10m. Breedte 1,2m.

Order nr.	751988120
Orig. nr.	FRSRM1200
Prijs	€ 74,00

TENGOOLS



90° of 180° combinatieslot.

Order nr.	165840109	160770301
Orig. nr.	TC-90CLOCK	TC-180CLOCK
Voor type	top coffer en TCW803N	tussenkoffers en TCW karren
Prijs	€ 16,50	16,50

TENGOOLS



Slot met sleutel voor TCW-wagen serie 7, 8 en 9.

Order nr.	03270204
Orig. nr.	TCDRK
Prijs	€ 8,50

TENGOOLS



Set van 3 sloten, 1 sleutel en 1 reservesleutel. Geschikt voor TCMM10011N en TCMM715N sets met sleutelslot.

Order nr.	144060100
Orig. nr.	TC-LOCK3
Prijs	€ 24,90

TENGOOLS



Set van 5 sloten, 1 sleutel en 1 reservesleutel. Praktisch voor de eigenaars van diverse gereedschapsets bestaande uit verschillende koffers en die slechts 1 sleutel willen. Geschikt voor alle standaard Teng wagens en koffers met sleutelslot. Prijs voor de complete set.

Order nr.	110230109
Orig. nr.	TC-LOCK5
Prijs	€ 35,50

TENGOOLS



Slot met sleutel voor topkoffers 704/706/802/804/806/813.

Order nr.	03270204	03420204
Orig. nr.	TCDRK	TCPRK
Prijs	€ 8,50	7,30

METALWORKS



Mobiele werktafel. Stevige gelaste stalen constructie.

- met zijdelingse duwbaar en slot
- 2 vaste wielen, 2 draaibare met rem
- hamerslag gelakt in grijs en rood
- capaciteit leggers 50kg
- ingelegd bovenblad in multiplex 40mm

Order nr.	856001150	
Orig. nr.	DEW12060P	
Aantal laden	0	
Aantal liggers	3	
Dikte multiplex plaat	mm	40
Capaciteit legplanken	kg	50
Capaciteit werkbank	kg	240
Gewicht	kg	65,00
Afmetingen (l x b x h)	mm	1200 x 600 x 950
Prijs	€	329,00

METALWORKS



Lade met ladeindeling (optioneel) en kast met 2 legborden

Mobiele werktafel. Stevige gelaste stalen constructie.

- met zijdelingse duwbaar en slot
- 2 vaste wielen, 2 draaibare met rem
- hamerslag gelakt in grijs en rood
- capaciteit leggers 50kg
- ingelegd bovenblad in multiplex 40mm
- met 3 lades, geschikt voor de Teng Tools TC Trays

Order nr.	856001140	
Orig. nr.	DEW12060L	
Aantal laden	3	
Aantal liggers	2	
Dikte multiplex plaat	mm	40
Capaciteit legplanken	kg	50
Capaciteit werkbank	kg	240
Capaciteit lades	kg	50
Gewicht	kg	80,00
Afmetingen (l x b x h)	mm	1200 x 600 x 950
Prijs	€	419,00

METALWORKS



Mobiele werktafel. Stevige gelaste stalen constructie.

- met zijdelingse duwbaar en slot
- 2 vaste wielen, 2 draaibare met rem
- hamerslag gelakt in grijs en rood
- capaciteit leggers 50kg
- ingelegd bovenblad in multiplex 40mm

Order nr.	856001155	
Orig. nr.	DEW12060K2	
Aantal laden	0	
Aantal liggers	4	
Dikte multiplex plaat	mm	40
Capaciteit legplanken	kg	50
Capaciteit werkbank	kg	240
Gewicht	kg	50,00
Afmetingen (l x b x h)	mm	1200 x 600 x 950
Prijs	€	339,00

METALWORKS



Lade met ladeindeling (optioneel)

Mobiele werktafel. Stevige gelaste stalen constructie.

- met zijdelingse duwbaar en slot
- 2 vaste wielen, 2 draaibare met rem
- hamerslag gelakt in grijs en rood
- ingelegd bovenblad in multiplex 40mm
- met 6 lades, geschikt voor de Teng Tools TC Trays

Order nr.	856001145	
Orig. nr.	DEW12060L2	
Aantal laden	6	
Aantal liggers	0	
Dikte multiplex plaat	mm	40
Capaciteit werkbank	kg	240
Capaciteit lades	kg	50
Gewicht	kg	92,00
Afmetingen (l x b x h)	mm	1200 x 600 x 950
Prijs	€	484,00



METALWORKS



Gereedschapswagen. Met 7 afsluitbare rolgelagerde lades. 2 geperforeerde zijkanen (hierop passen Modular haken), 2 geremde zwenkwieien, rubber bovenmat. Handvat.

Order nr.	856001107	†
Orig. nr.	GW107	
Aantal lades	7	
Afmetingen middelgrote lade	mm	580x410x75 (x5)
Afmetingen grote lade	mm	580x410x160 (x2)
Gewicht	kg	60,00
Afmetingen (l x b x h)	mm	840 x 480 x 940
Prijs	€	309,00

METALWORKS



Gereedschapswagen met zeer robuust frame. Met 15 afsluitbare rolgelagerde lades. 2 geperforeerde zijkanen (hierop passen Modular haken), 2 geremde wielen, rubber bovenmat en handgreep. De lades zijn op maat gemaakt voor uw tool-trays.

Order nr.	856001117	†
Orig. nr.	GW115	
Aantal lades	15	
Afmetingen kleine lade	mm	580x410x72 (x2)
Afmetingen middelgrote lade	mm	580x410x150 (x2)
Afmetingen grote lade	mm	1240x410x72 (x1)
Gewicht	kg	100,00
Afmetingen (l x b x h)	mm	1408 x 470 x 1050
Prijs	€	659,00

METALWORKS



Werkplaatswagen met 3 plateaus. Met 2 vaste en 2 zwenkwieien met rem.

Order nr.	751503000	€
Orig. nr.	DERG003	
Maximum gewicht per lade	kg	45
Aantal liggers		3
Gewicht	kg	15,00
Afmetingen (l x b x h)	mm	900 x 430 x 800
Prijs	€	85,00

HECCO



HE1391BL



HE1392BL

Materiaalkar. In plaatstaal 10/10mm, lateraal 30/10mm. Met kunststof wielen diameter 75mm.

Order nr.	761001059	€	761001060	€
Orig. nr.	HE1391BL		HE1392BL	
Gewicht	kg	14,50	18,50	
Afmetingen (l x b x h)	mm	700 x 450 x 800	810 x 480 x 900	
Prijs	€	164,00	176,00	

HECO



HE1401BL

HE1402BL

Materiaalkar. Gelast in plaatstaal 10/10mm, lateraal 30/10mm. Met kunststof wielen diameter 75mm.

Order nr.	761001061	761001062	761001063
Orig. nr.	HE1401BL	HE1402BL	HE1403BL
Gewicht	kg 13,80	16,55	16,50
Afmetingen (l x b x h)	mm 630 x 350 x 825	760 x 400 x 825	760 x 400 x 825
Prijs	€ 154,00	190,00	285,00

HECO



HE1461BL

HE1462BL

Materiaalkar. Gelast in plaatstaal 10/10mm, lateraal 30/10mm. Met papierrolhouder en kunststof wielen diameter 75mm.

Order nr.	761001117	761001118
Orig. nr.	HE1461BL	HE1462BL
Gewicht	kg 21,54	21,50
Afmetingen (l x b x h)	mm 760 x 400 x 850	760 x 400 x 100
Prijs	€ 260,00	344,00

HECO



HE1341BL

HE1342BL

Materiaalkar. In plaatstaal 20/10mm, lateraal 30/10mm. Met kunststof wielen diameter 75mm en kunststof beschermmat.

Order nr.	761000920	761000921
Orig. nr.	HE1341BL	HE1342BL
Gewicht	kg 32,40	35,00
Afmetingen (l x b x h)	mm 760 x 400 x 880	760 x 400 x 880
Prijs	€ 305,00	369,00

HECO



HE1161BL

HE1162BL

Materiaalkar. In plaatstaal 10/10mm. Met kunststof wielen diameter 75mm.

Order nr.	761000522	761000524	761000526
Orig. nr.	HE1161BL	HE1162BL	HE1163BL
Gewicht	kg 34,70	42,10	42,32
Afmetingen (l x b x h)	mm 640 x 360 x 915	640 x 360 x 915	640 x 360 x 915
Prijs	€ 565,00	815,00	715,00

HECO



HE1170BL

HE1171BL

HE1172BL

Materiaalkar. In plaatstaal 10/10mm. Met kunststof wielen diameter 75mm. Met anti-omkeer beveiliging en 3 onderverdelingen per lade.

Order nr.	761000528	761000536
Orig. nr.	HE1170BL	HE1171BL
Gewicht	kg 49,80	49,80
Afmetingen (l x b x h)	mm 640 x 360 x 915	640 x 360 x 915
Prijs	€ 525,00	635,00

Order nr.	761000537	761000538
Orig. nr.	HE1172BL	HE1173BL
Gewicht	kg 51,00	53,30
Afmetingen (l x b x h)	mm 640 x 360 x 915	640 x 360 x 915
Prijs	€ 685,00	785,00

Organiseer u met Teng Tools!

Teng Tools is uniek omdat het een compleet systeem aanbiedt, welke u in staat stelt om uw eigen tool kit op een gestructureerde en zeer georganiseerde manier samen te stellen.

Er is keuze uit verschillende types tool boxen en meer dan 100 verschillende tool trays die ondersteund worden door de click & fill webtoepassing. Om de keuze gemakkelijker te maken heeft Teng Tools een selectie van aanbevolen tool kits samengesteld.

Van een kleine draagbare tool kit tot de gigantische 1001 delige Mega Master; de aanbevolen sets zijn samengesteld in samenwerking met experts uit de automotive en industrie.



- Kies uit onze aanbevolen persoonlijke kit.

- Keuze uit meer dan 800 EVA Trays van dubbele breedte van volledige breedte. De EVA Trays bieden maximaal georganiseerde tool kits te compileren.

- Keuze uit meer dan 100 ladekasten en draagbare tool kits.

- Maak een complete tool kit om een bijna complete gereedschapset voor iedere mogelijke taak.

BEKIJK DE VIDEO



Gereedschaps-sets



en tool kits of ontwerp uw

30 verschillende TC trays, TC
edte, meer dan 20 TTX Trays
e, 8 PS Trays van ladebreedte en
de flexibiliteit om individuele,
seerde en plaatsbesparende tool

dan 20 gelagerde tool boxen,
raagbare TC Tray sets.

ombinatie van trays en tool boxen
eindeloze variëteit aan tool kits voor
lijke toepassing te creëren.

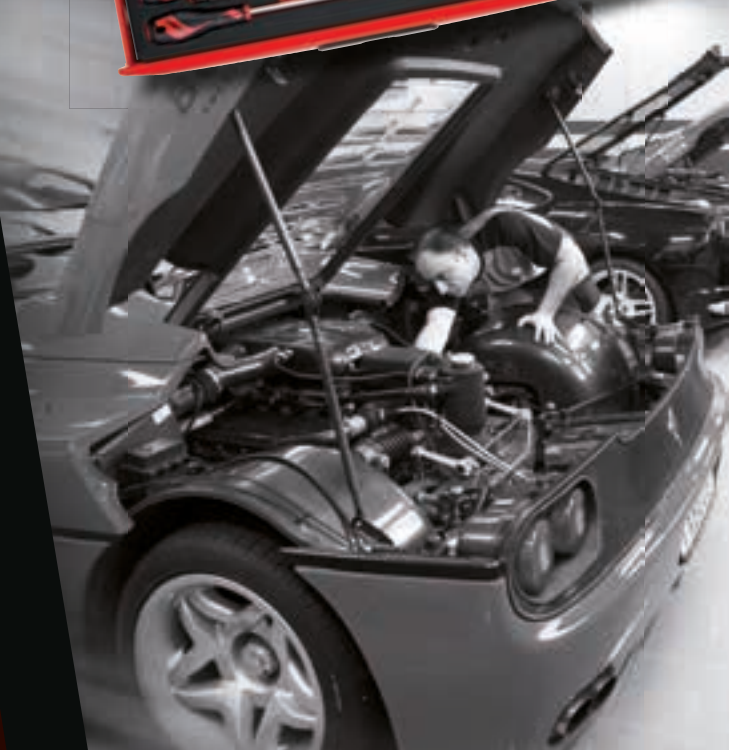

Gereedschapsets

TENGOOLS



85-delige set gereedschappen. In een handige rode Teng koffer met vijf verdelingen (TC422). De set bestaat uit sleutels, schroevendraaiers, tangen, slaggereedschap, service Tools en een doppenset 1/2".

Inhoud:

- 9-delige allensleutelset (1479MM - 112260104)
- Griptang (401-10 - 74250101)
- Universeel breekmes (710 - 105860100)
- Platte beitel 200 mm (CC200F - 117021006)
- Bankhamer (HMEG800 - 117030304)
- Kniptang (MB441-6T - 109740209)
- Combinatietang (MB452-7T - 109770206)
- Lange rechte bektang (MB461-8T - 109780205)
- Circlipstang inwendig (MB470-7 - 34960104)
- Circlipstang uitwendig (MB472-7 - 35020106)
- Universele waterpomptang (MB481-10T - 109420208)
- Schroevendraaier plat 0,5x3,0mm (MD920N - 177760402)
- Schroevendraaier plat 1,0x5,5mm (MD922N - 177761152)
- Schroevendraaier plat 1,2x6,5mm (MD932N - 177762002)
- Schroevendraaier PH2 (MD952N - 177771201)
- Schroevendraaier PZ2 (MD962N2 - 177780707)
- 6-delige doorslagenset (PPS06 - 69110104)
- 21-delige doppenset 1/2" 6-kant (T1221-6 - 167240209)
- 21-delige steekringsleutelset (6521 - 185830205)
- 11-delige steeksleutelset (6211 - 185810207)

Order nr.	728091085	
Orig. nr.	SDAL85	
Aantal stuks	85	
Type koffer	TC422	
Gewicht	kg	21,00
Afmetingen (l x b x h)	mm	560 x 205 x 205
Prijs	€	395,00

TENGOOLS



TOOLS

Teng Tools Service Case. Technician Starter Set. Assortiment van 9 TC trays gereedschap opgeslagen in de Teng Service Case bestaande uit een serie doppen en accessoires 1/4", 3/8" en 1/2", Mega Bite tangen, Mega Drive schroevendraaiers, zeskantsleutels op T-handvat en een serie steekringsleutels.

Order nr.		144290103
Orig. nr.		SC01
Aantal stuks		113
Type koffer		TC-SC
Gewicht	kg	12,90
Afmetingen (l x b x h)	mm	500 x 400 x 240
Prijs	€	499,00

Samenstellingslijst:

Orig. nr.	Order nr.	Lade	Omschrijving
TT1217	03570207	1	17-delige doppen set 1/2"
TT1236	27560101	1	12-delige set met metrische steekringsleutels
TT440-T	109820101	1	4-delige tangen set
TT917N	174400101	2	7-delige schroevendraaierset
TT917TXN	174410100	2	7-delige schroevendraaierset TX/TPX
TTHX7	68930106	2	7-delige metrische T-hendel set
TT1435	03490109	3	35-delige metrische doppen set 1/4"
TT3819	03520103	3	19-delige metrische doppen set 3/8"
TT1205	03570108	3	5-delige accessoiresset 1/2"

TENGOOLS



Teng Tools Service Tray. Basisset service gereedschap geschikt voor de Teng Service Case TS-SC en de Teng opberg koffer TC-3. De set bestaat uit griptang 235mm, breekmes, rolmeter 3m, schroefleutel 4003, zaagbeugel 300mm en een bankhamer 500gr.

Order nr.		144440104
Orig. nr.		SCPS01E
Gewicht	kg	1,90
Afmetingen (l x b x h)	mm	540 x 262 x 56
Prijs	€	76,90



TENGOOLS



Teng Tools Service Case. Assortiment van 6 TC trays gereedschap opgeslagen in de Teng Service Case bestaande uit een gamma doppen en accessoires 1/4" en 3/8", tangenset, schroevendraaiers, allensteutels en een serie steekringsleutels.

Order nr.	801200762	
Orig. nr.	SC06	
Aantal stuks	105	
Type koffer	TC-SC	
Gewicht	kg	16,00
Afmetingen (l x b x h)	mm	500 x 400 x 240
Prijs	€	419,00

Samenstellingslijst:

Orig. nr.	Order nr.	Lade	Omschrijving
TT1236	27560101	1	12-delige steekringsleutel Tctray 8-19
TT1435	03490109	1	35-delige doppenset 1/4 Tctray
TT3819	03520103	1	19-delige doppenset Tctray 3/8
TT440-T	109820101	2	4-delige tangenset Tctray TPR
TT917N	174400101	2	7-delige schroevendraaierset Tctray
TTHT28	128250107	2	28-delige hex en Tx-set Tctray



TENGOOLS

Teng Tools Service Case. Assortiment van 9 TC trays gereedschap opgeslagen in de Teng Service Case bestaande uit een gamma doppen en accessoires 1/4", 3/8" en 1/2", Mega Bite tangen, Mega Drive schroevendraaiers, allensleutels, griptangen, mini tang- en schroevendraaierset en bitsset met ratel.

Order nr.		801200763
Orig. nr.		SC09
Aantal stuks		200
Type koffer		TC-SC
Gewicht	kg	19,00
Afmetingen (l x b x h)	mm	500 x 400 x 240
Prijs	€	549,00

Samenstellingslijst:

Orig. nr.	Order nr.	Lade	Omschrijving
TT1236	27560101	1	12-delige steekringsleutels Tc-tray 8-19
TT1435	03490109	1	35-delige doppenset 1/4 Tc-tray
TT3819	03520103	1	19-delige doppenset Tc-tray 3/8
TT440-T	109820101	2	4-delige tangenset Tc-tray TPR
TT917N	174400101	2	7-delige schroevendraaierset Tc-tray
TTHT28	128250107	2	28-delige hex en Tx-set Tc-tray
TTMI16	104450101	3	16-delige tangen- en schroevendraaierset Mini Tc-tray
TTVG05	122480106	3	5-delige griptangenset
TTMD74	144030103	3	74-delige bitsset met ratel Tc-tray

MASTER TOOLSET 491



TCW807N

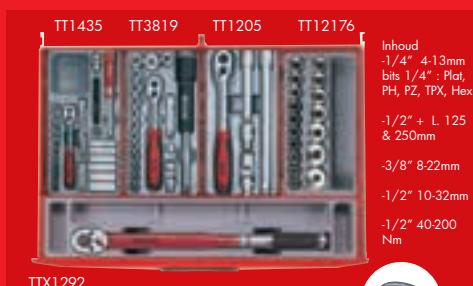

TTX1292

Inhoud
-1/4" 4-13mm
bits 1/4" : Plat,
PH, PZ, TPX, Hex
-1/2" + L 125
& 250mm
-3/8" 8-22mm
-1/2" 10-32mm
-1/2" 40-200
Nm



TTXF05

Inhoud
-Hex 2,5-8mm
-TX/TPX 10-40
-L175mm
-Tangen
-L 250mm

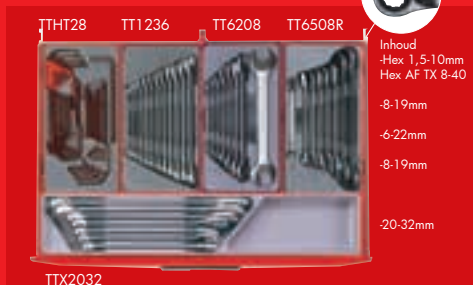

TTX2032

Inhoud
-Hex 1,5-10mm
Hex AFTX 8-40
-8-19mm
-6-22mm
-8-19mm
-20-32mm



TTX00

Inhoud
-servicetray



TTX00 + 710G

Inhoud
-TX 6-45
-Plat, PH, PZ



VES1000 + TTX00

Inhoud
-299pcs
-bits plat, PH,
PZ, Hex, TX,
TPX, SQ
-inspectie
-AWG 10-22,
DIN 0.5 - 6mm²

TENGTOOLS

De 491-delige Midi Master Toolset. De populairste Teng Tools basis toolset bestaat uit een samenstelling van 491 tools in het unieke Teng Tray systeem, opgeslagen in een gereedschapswagen. Deze set bevat een assortiment van doppen en accessoires 1/4", 3/8" en 1/2", momentsleutel 1/2", rolmeter, beugelzaag, breekmes, schroefleutel, meetlat, schroevendraaiers, bitssets met handvat, allensleutels, tangen, kabelkrimptang met kabelschoenen, steek- en steekringsleutels, circlipstangen, griptang, Tx- en Hex T-sleutels, inspectieset en vijlenset. Voor details zie onderstaande samenstellingslijst.

Order nr.	122400104 ⓘ		
Orig. nr.	TCMM491NE		
Aantal stuks	490		
Type wagen	TCW807N		
Gewicht	kg	105,80	
Afmetingen (l x b x h)	mm	670 x 460 x 950	
Prijs	€	1.399,00	

Samenstellingslijst:

Orig. nr.	Order nr.	Lade	Omschrijving
TT1435	03490109	1	35-delige metrische doppenset 1/4"
TT3819	03520103	1	19-delige metrische doppenset 3/8"
TT1205	03570108	1	5-delige accessoierset 1/2"
TT12176	03570256	1	17-delige doppenset 1/2" 6-kant
TTX1292	73190100	1	Momentsleutel 1/2 40-210Nm
TTHT28	128250107	2	28-delige hex en Tx-set
TT1236	27560101	2	12-delige set met metrische steekringsleutels
TT6208	03900107	2	Set van 8 dubbelsteeksleutels DIN 3110 gaande van 6 tot 22 mm
TT6508R	109730101	2	8-delige ratel-steekringsleutel T-tray
TTX2032	68910108	2	7-delige metrische steeksleutelset
TTX00	101030203	3	Ledige TX-tray lang model
TTD912TXN	174380105	3	12-delige schroevendr. TX-set TTD tray
TTD914N	174370106	3	15-delige schroevendr. Pl-ph-pz TTD-tray
710G	177710308	3	Breekmes
TTHEX7	68930106	4	7-delige metrische allensleutel met T-handvat
TTTX7	68920107	4	7-delige TX/TPX T-handvat torxset
TT474-7	04030102	4	4-delige 7" circlipstang
TT440-T	109820101	4	4-delige tangenset
TTXF05	128440104	4	5-delige vijlenset
TTPS09E	117060103	5	9-delige basis-tools set (DIN1041-hamer)
TTD02T99	161800310	6	299-delig assortiment van de meest gangbare geïsoleerde kabelschoenen
TTMD74	144030103	6	74-delige bitsset met ratel
TTIM03	109460105	6	3-delige inspectieset
VES1000	100072188	6	Kabelschoenkrimptang

MEGA MASTER TOOLSET 1001



TCMM1001NE

Deze Mega Master Tools Set bestaat uit een samenstelling van 1205 tools in het unieke Teng Tray systeem, alles opgeslagen in een stack van de TCW810N wagen, TC803N tussenkoffer en de TC806NF topkoffer of in een brede wagen en topkoffer. Deze set bevat een assortiment van doppen en accessoires 1/4", 3/8", 1/2" en 3/4" MM tot 50mm en deels AF, schroevendraaiers, bitssets met handvat, slagdoppen en slagdopbitsen, slagschroevendraaier, diverse auto en service tools, beitels en doorslagen, gewone en naaldvijlen, slaggereedschap, koevoeten, allensleutels, momentsleutels 3/8" en 1/2", 1000V-tangen en schroevendraaiers, kabelkrimpang, ringsleutels tot 32mm, steek- en steekringsleutels MM tot 32mm en AF, kniesleutels, diverse dopbitsen, de klassiek tangen, circlips en griptangen, dopschroevendraaiers, riveteertang, blindnietang en haakpinsleutels. Voor details zie op bijgevoegde samenstellingslijst.



TT1435 TT3819 TT1205 TT12176
LADE 7
 Inhoud
 -1/4" 4-13mm
 bits 1/4": Plat,
 PH, PZ, TPX, Hex
 -1/2" + L 125 &
 250mm
 -3/8" 8-22mm
 -1/2" 10-32mm
 -1/2" 40-200 Nm
 TTX1292



JTH28 TT1236 TT6208 TT6508R
LADE 8
 Inhoud
 -Hex 1,5-10mm
 Hex AF TX 8-40
 -8-19mm
 -6-22mm
 -8-19mm
 -20-32mm
 TTX2032



TTD912TXN TTD914N
LADE 9
 Inhoud
 -TX 6-45
 -Plat, PH, PZ
 TTX00 + 710G



TTHEX7 TTX7 TT474-7 TT440-T
LADE 10
 Inhoud
 -Hex 2,5-8mm
 -TX/TPX 10-40
 -L175mm
 -Tangen
 -L 250mm
 TTXF05



TTD021229 TTMD74 TTTM03
LADE 12
 Inhoud
 -299pcs
 -bits plat, PH,
 PZ, Hex, TX,
 TPX, SQ
 -inspectie
 -AWG 10-22,
 DIN 0.5 - 6mm²
 VES1000 + TTX00



TTPC09 TTID20 TTMD12D TTV907N
LADE 13
 Inhoud
 -3-8mm
 -Plat, PH,
 Hex, TX
 -Plat, PH, PZ,
 TX, Hex
 -Plat, PH, PZ
 TTX01

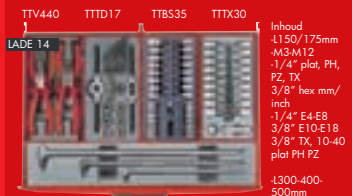

TTV440 TTTD17 TTBS35 TTTX30
LADE 14
 Inhoud
 -L150/175mm
 -M3-M12
 -1/4" plat, PH,
 PZ, TX
 -3/8" hex mm/
 inch
 -1/4" E4-E8
 -3/8" E10-E18
 -3/8" TX, 10-40
 plat PH PZ
 -L300-400-
 500mm
 TTXP83

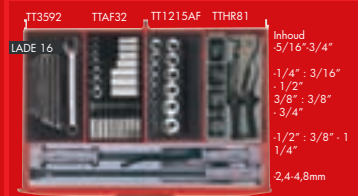

TT804 TT9116 TTHEX23 TTNF12
LADE 15
 Inhoud
 -cap. 100mm x
 130mm
 -1/2" 13-24mm
 -Hex 5-19mm
 L 40 & 75mm
 -L163mm
 -6-32mm
 TTX6311



TTD02 TTIS15 TTVG05
LADE 1
 Inhoud
 -1/2" Hex
 7-12mm & TX
 20-60
 TTXEXT13 TTXMDN
LADE 2
 Inhoud
 -1/4" 3/8"
 1/2"
 -5-12mm
 TTX3404 TTX3414
LADE 3
 Inhoud
 -clips 1/4, 3/8,
 1/2
 -L125mm
 -10-19mm
 -8x9 - 18x19mm

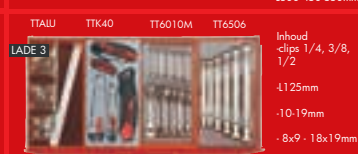

TT3592 TTAF32 TT1215AF TTHR81
LADE 16
 Inhoud
 -5/16"-3/4"
 -1/4": 3/16"
 -1/2": 3/8"
 -3/8": 3/8"
 -3/4"
 -1/2": 3/8" - 1
 1/4"
 -2-4,8mm
 -L300-450-550mm



TTHC03 TTHP08 TTMI16 TTNR81
LADE 4
 Inhoud
 -Ø 1/4, 3/4,
 1/4-1 1/4, 3/4
 -2 1/4
 -19-50, 30-75,
 50-120
 plat, PH, TX,
 125mm
 -cap. M3 - M6
 TTOS16 TTISN11 TTRO4 TTX23
LADE 5
 Inhoud
 -carter:
 5/16"x3/8",
 1-1-4mm,
 boegje 3/8"
 16&21mm
 -7/64 - 19/6,
 extract. 6-12
 -TX 20-55mm
 L 40 & 75mm



TTX3404 TTX3414
LADE 6
 Inhoud
 -3/4 + 2
 verlengstukken
 200 & 400mm
 -3/4" 19-50mm

SET
1001

Order nr.	122390107 		
Orig. nr.	TCMM1001NE		
Aantal stuks	1205		
Type wagen-koffer	TCW810N+TC803N+TC806NF		
Gewicht	kg	161,79	
Afmetingen (l x b x h)	mm	460 x 670 x 950	
Prijs	€	3.249,00	

Samenstellingslijst:

Orig. nr.	Order nr.	Lade	Omschrijving
TTD02	161800305	1	Ledige DTC-tray met 16-vak verdeling
TTRS15	143880102	1	15-delige set dopbitsen Ribe en Spline
TTVG05	122480106	1	5-delige griptangenset
TTXEXT13	68870104	2	13-delige verlengstukkenset
TTXMDN	114590102	2	9-delige schroevendraaiers op dop 5-13mm
TTALU	03890100	3	32-delige dop clip rail set
TTK40	174480103	3	5-delige messenset
TT6010M	109470104	3	10-delige Midget steekringsleutels kort
TT6506	73000101	3	6-delige kniesleutelset
TTHC03	118420108	4	3-delige slangklemtangenset
TTHP08	102120102	4	8-delige haak- en pinsleutelset
TTM16	104450101	4	16-delige mini tangen- en schroevendraaierset
TTNR81	106190101	4	81-delige blindnietmoerenset
TTOS16	03960101	5	16-delige olie service set
TTSN11	69340107	5	11-delige extractorset
TTSR04	117690107	5	4-delige schraper- en verwijderst
TTX23	68860105	5	23-delige biten Tx-Tc 40 - 75mm 20 70Tx
TTX3404	101530103	6	4-delige set dopaccessoires met 3/4" aansluiting
TTX3414	101540102	6	14-delige doppenst met 3/4" aansluiting metrisch
TT1435	03490109	7	35-delige metrische doppenst 1/4"
TT3819	03520103	7	19-delige metrische doppenst 3/8"
TT1205	03570108	7	5-delige accessoirest 1/2"
TT12176	03570256	7	17-delige doppenst 1/2" 6-kant
TTX1292	73190100	7	Momentsleutel 1/2 40-210Nm
TTHT28	128250107	8	28-delige hex en Tx-set
TT1236	27560101	8	12-delige set met metrische steekringsleutels
TT6208	03900107	8	8-delige metrische steeksleutelset
TT6508R	109730101	8	8-delige ratel-steekringsleutel Tc-tray
TTX2032	68910108	8	7-delige metrische steeksleutelset
TTX00	101030203	9	ledige TX-tray lang model
TTD912TXN	174380105	9	12-delige schroevendr. TX-set
TTD914N	174370106	9	14-delige schroevendr. Ph-ph-pz TTD-tray
710G	177710308	9	Breekmes
TTHEX7	68930106	10	7-delige metrische T-hendelset
TTX7	68920107	10	7-delige TX/TPX T-handvat torxset
TT474-7	04030102	10	4-delige circlipstang 7"
TT440-T	109820101	10	4-delige tangenset
TTXF05	128440104	10	5-delige vijlenset
TTFS09E	117060103	11	9-delige basis-tools set (DIN1041-hamer)
TTD021299	161800310	12	299-delig assortiment van de meest gangbare geïsoleerde kabelschoenen
TTMD74	144030103	12	74-delige bitsset met ratel
TTTM03	109460105	12	3-delige inspectieset Tc-tray 3dlg.
VES1000	100072188	12	Kabelschoenkrimptang
TTPC09	69220101	13	9-delige beitel- en doorslagset Tc-tray
TTID20	102100104	13	20-delige slagschroevendr. set 1/2
TTMD12D	128650108	13	12-delige set lange biten-handv.
TTV907N	178710109	13	7-delige schroevendraaierset 1000V
TTX01	109450106	13	ledige TX-tray met 6-vak verdeling
TTV440	117490102	14	4-delige tangenset 1000V
TTD17	69190106	14	17-delige tappen- en snijkussenset
TTBS35	132150103	14	35-delige dop- en bitsset 1/4
TTX30	102140100	14	30-delige torx set 1/4-3/8 Tx,TPX,Tx,E
TTXPB3	100690106	14	3-delige koevoetset 300-400-500mm
TT804	03980109	15	4-delige poulietrekkerst
TT9116	68800101	15	Slagdoppen 1/2" 6-kant
TTHEX23	68850106	15	23-delige biten Hex
TTNF12	128430105	15	12-delige set naaldvijlen
TTX6311	68910157	15	11-delige ringsleutels Tx-tray 6-32mm
TT3592	58050303	16	8-delige steekringsleutels AF 8
TTAF32	68610104	16	32-delige doppenst AF
TT1215AF	03570306	16	15-delige doppenst 1/2" AF
TTHR81	69210102	16	81-delige riveteerset Tc-tray
TTXPB3A	117860106	16	3-delige barensset universeel

MINI MASTER TOOLSET 158 - 180 - 210

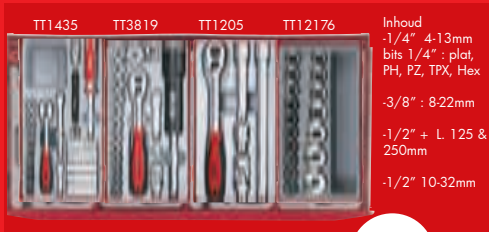

Inhoud
-1/4" 4-13mm
bits 1/4" : plat,
PH, PZ, TPX, Hex
-3/8" : 8-22mm
-1/2" + L. 125 &
250mm
-1/2" 10-32mm



Inhoud
-1/4" 4-13mm
bits 1/4" : plat,
PH, PZ, TPX, Hex
-3/8" : 8-22mm
-1/2" + L. 125 &
250mm
-1/2" 10-32mm



Inhoud
-Hex 1,5-10mm
Hex AF TX 8-40
-8-19mm
-6-22mm
-8-19mm



Inhoud
-8-19mm
-Tangen



Inhoud
-TX6 -45
-plat, PH, PZ



Inhoud
-Hex 1,5-10mm
Hex AF TX 8-40

SET
158

SET
210



Inhoud
-Hex 2,5-8mm
-TX/TPX 10-40
-L175mm
-Tangen

SET
180

Orig. nr.	Order nr.	158	180	210	Omschrijving
TT1435	03490109	✓	✓	✓	35-delige metrische doppenset 1/4"
TT3819	03520103	✓	✓	✓	19-delige metrische doppenset 3/8"
TT1205	03570108	✓	✓	✓	5-delige accessoiresset 1/2"
TT12176	03570256	✓	✓	✓	17-delige doppenset 1/2" 6-kant
TTHT28	128250107	✓	✓	✓	28-delige hex en Tx-set
TT1236	27560101	✓	✓	✓	12-delige set met metrische steekringsleutels
TT6208	03900107	✓	✓	✓	8-delige metrische steeksleutelset
TT6508R	109730101	✓	✓	✓	8-delige ratel-steekringsleutel Tc-tray
TT917N	174400101			✓	7-delige schroevendraaierset
TT440-T	109820101			✓	4-delige tangenset
TTALU	03890100			✓	32-delige dop clip rail set
TTD912TXN	174380105	✓	✓	✓	12-delige schroevendr. TX-set
TTD914N	174370106	✓	✓	✓	14-delige schroevendr. Pl-ph-pz TTD-tray
TTNF12	128430105			✓	12-delige set naaldvijlen
TTDB28	151440104			✓	28-delige borensset
TTMD12D	128650108			✓	12-delige set lange bitsen+handv.
TTHEX7	68930106		✓	✓	7-delige metrische Thendelset
TTTX7	68920107		✓	✓	7-delige TX/TPX T-handvat torxset
TT474-7	04030102		✓	✓	4-delige circlipstang 7-175mm
TT440-T	109820101		✓	✓	4-delige tangenset

**SET
158**
**SET
180**
**SET
210**

TC803SV

 TCMM158803SV
801008569

TC803N

 TCMM158803N
801008574

 TCMM158806NF
801008576

TC806NF

TC806MX

 TC8211MX
801008211

TC804N

 TCMM158804N
801008572

 TCMM180804N
801008578

 TCMM158804NS
801008575

 TCMM180804NS
801008577

TC804NS

Mini Master Toolset 158-180-210. Set bestaande uit 1 gereedschapskoffer en een assortiment doppen en accessoires 1/4", 3/8" en 1/2" van 4 tot 32mm, steekringsleutels, schroevendraaiers, tangen, Allensleutels. Voor details zie onderstaande samenstellingslijst.

Order nr.	Orig. nr.	Type koffer	Aantal stuks	Afmetingen (l x b x h) mm	Gewicht kg	Prijs €
801008569 T	TCMM158803SV	TC803SV	158	660x307x251	13,80	559,00
801008574 T	TCMM158803N	TC803N	158	660x305x250	13,80	599,00
801008576 T	TCMM158806NF	TC806NF	158	660x305x380	22,00	665,00
801008572 T	TCMM158804NS	TC804NS	158	660x305x380	21,00	655,00
801008575 T	TCMM158804N	TC804N	158	660x305x380	21,00	635,00
801008577 T	TCMM180804NS	TC804NS	180	660x305x380	21,00	769,00
801008578 T	TCMM180804N	TC804N	180	660x305x380	21,00	749,00
801008211 T	TC8211MX	TC806MX	210	660x305x380	39,00	659,00

HD MASTER TOOLSET 385 - 445 - 495

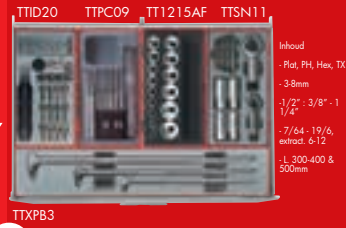
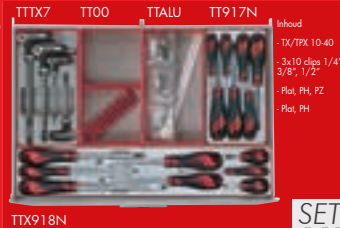
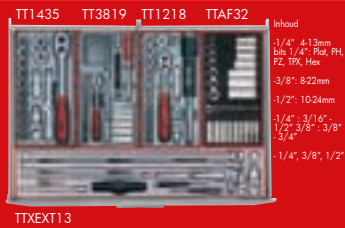

SET 385

SET 445













SET 495

Orig. nr.	Order nr.	Lade	385	445	495	Omschrijving
TT1218	39180104	1	✓	✓	✓	18-delige doppenet 1/2"
TT1435	03490109	1	✓	✓	✓	35-delige doppenet 1/4"
TT3819	03520103	1	✓	✓	✓	19-delige doppenet 3/8"
TTAF32	68610104	1	✓	✓	✓	32-delige doppenet 1/4" en 3/8" kort/lang
TTXEXT13	68870104	1	✓	✓	✓	13-delige verlengstukkenet
TT440-T	109820101	2	✓	✓	✓	4-delige tangenset
TT474-7	04030102	2	✓	✓	✓	4-delige 7" cirdlipstang
TT1236	27560101	2	✓	✓	✓	12-delige set met metrische steekringsleutels
TT3592	58050303	2	✓	✓	✓	8-delige steekringsleutels AF 8
TTX2640	68910207	2	✓	✓	✓	7-delige AF steeksleutelset
TTBS35	132150103	3	✓	✓	✓	35-delige dop- en bitsset 1/4"
TTHEX7AF	68930205	3	✓	✓	✓	7-delige metrische Thendelset
TTHT28	128250107	3	✓	✓	✓	28-delige hex en Tx-set
TTMD74	144030103	3	✓	✓	✓	74-delige bitsset met ratel
TTX00	101030203	3	✓	✓	✓	Ledige TX-tray lang model
3892-E3	73190076	3	✓	✓	✓	Momentsleutel 3/8" 19-110Nm
TTX7	68920107	4	✓	✓	✓	7-delige TX/TPX T-handvat torxsset
TT00	04160107	4	✓	✓	✓	Ledige Tc-tray
TTAU	03890100	4	✓	✓	✓	32-delige dop clip rail set
TT917N	174400101	4	✓	✓	✓	Set van 7 schroevendraaiers plat, PH en PZ. TT-MV PLUS staal
TTX918N	174500108	4	✓	✓	✓	5-delige schroevendraaiers plat en PH waarvan 2 stubby
TTPO9E	117060103	5	✓	✓	✓	9-delige hamerkit
600536	72672702	5	✓	✓	✓	Steekringsleutel 36mm jumbo
MD-SCR	03130101	5	✓	✓	✓	Pakkingschroper 24mm x 245mm
920230	114872807	5	✓	✓	✓	Slagkop diep 1/2" 6 - 15/16"
TTX00	101030203	5	✓	✓	✓	Ledige TX-tray lang model
TTID20	102100104	6	✓	✓	✓	20-delige slagschroevendr. set 1/2
TTPO9	69220101	6	✓	✓	✓	9-delige beitel- en doorslagset Tc-tray
TT1215AF	03570306	6	✓	✓	✓	15-delige doppenet 1/2" AF
TTSN11	69340107	6	✓	✓	✓	11-delige extractorset
TTXPB3	100690106	6	✓	✓	✓	3-delige koevoetset
TT6508R	109730101	7	✓	✓	✓	8-delige ratel-steekringsleutel Tc-tray
TTHEX7	68930106	7	✓	✓	✓	7-delige metrische Thendelset
TTADP17	185800109	7	✓	✓	✓	17-delige adaptor set - TC tray
TTM08	144370103	7	✓	✓	✓	8-delige inspectieset
TTX6311	68910157	7	✓	✓	✓	11-delige ringsleutels Tx-tray 6-32mm
580	15610108	7	✓	✓	✓	Magnetische bits tray
409	117780106	7	✓	✓	✓	Multifunctionele tang met een verstelbare opening van 53 tot 118 mm.
LI300	128600103	7	✓	✓	✓	Multimeter

	SET 385	SET 445	SET 495	
 TCW807NS	TCHD385NS 801008596	TCHD445NS 801008600	TCHD495NS 801008604	 TCW807N
	TCHD385N 801008594	TCHD445N 801008598	TCHD495N 801008602	
 TCW807NO	TCHD385NO 801008595	TCHD445NO 801008599	TCHD495NO 801008603	 TCW807SV
	TCHD385SV 801008593	TCHD445SV 801008597	TCHD495SV 801008601	

TCHD Motorset. De motorset bestaat uit 385, 445 of 495 stuks, en is ontworpen in samenwerking met het Husqvarna Racing Team onder begeleiding van Jacky Martens.

De sets bevatten ondermeer doppen en accessoires van 1/4", 3/8" en 1/2", een momentsleutel van 3/8", tangen, sleutels, dopbitsen, allensleutels, schroevendraaiers en een service tray.

Order nr.	Orig. nr.	Type wagen	Aantal stuks	Afmetingen (l x b x h) mm	Gewicht kg	Prijs €
801008596 	TCHD385NS	TCW807NS	385	670x460x950	91,70	1.449,00
801008594 	TCHD385N	TCW807N	385	670x460x950	102,70	1.429,00
801008595 	TCHD385NO	TCW807NO	385	670x460x950	91,70	1.449,00
801008593 	TCHD385SV	TCW807SV	385	670x460x950	95,70	1.359,00
801008600 	TCHD445NS	TCW807NS	445	670x460x950	98,50	1.599,00
801008598 	TCHD445N	TCW807N	445	670x460x950	109,49	1.579,00
801008599 	TCHD445NO	TCW807NO	445	670x460x950	98,49	1.599,00
801008597 	TCHD445SV	TCW807SV	445	670x460x950	110,76	1.519,00
801008604 	TCHD495NS	TCW807NS	495	670x460x950	106,76	1.809,00
801008602 	TCHD495N	TCW807N	495	670x460x950	117,76	1.789,00
801008603 	TCH495NO	TCW807NO	495	670x460x950	106,76	1.809,00
801008601 	TCHD495SV	TCW807SV	495	670x460x950	110,76	1.729,00

MASTER TOOLSET 188 - 215 - 491 - 632 - 721 - 926

TT1435 TT3819 TT1205 TT12176

Inhoud
-1/4" 4-13mm
bits/emb. 1/4"
: Plat, PH, PZ,
TPX, Hex
-1/2" + L 125
& 250mm
-3/8" 8-22mm
-1/2" 10-32mm
-1/2" 40-200
Nm

TTX1292

**SET
491**

TTD02T229 TTMD74 TTTM03

Inhoud
-299pcs
-bits/emb. plat,
PH, PZ, Hex, TX,
TPX, SQ
-inspectie/
inspection
-AWG 10-22,
DIN 0.5 - 6mm²

VES1000 + TTX00

TTH28 TT1236 TT6208 TT6508R

Inhoud
-Hex 1,5-10mm
Hex AF TX 8-40
-8-19mm
-6-22mm
-8-19mm
-20-32mm

TTX2032

**SET
632**

TTPC09 TTID20 TTMD12D TTV907N

Inhoud
-3-8mm
-Plat, PH, Hex, TX
-Plat, PH, PZ,
TX, Hex
-Plat, PH, PZ

TTX01

TTD912TXN TTD914N

Inhoud
-TX 6-45
-Plat, PH, PZ

TTX00 + 710G

**SET
721**

TTV440 TTD17 TTBS35 TTX30

Inhoud
-L150/175mm
-M3-M12
-1/4" plat, PH,
PZ, TX
3/8" hex mm/
inch
-1/4" E4-E8
3/8" E10-E18
3/8" TX, 10-40
plat PH PZ
-L300-400-
500mm

TTXPB3

TTHX7 TTX7 TT474-7 TT440-T

Inhoud
-Hex 2,5-8mm
-TX/TPX 10-40
-L175mm
-Tangen/pincen
-L 250mm

TTXF05

**SET
188**

TT804 TT9116 TTHX23 TTNF12

Inhoud
-cap. 100mm x
130mm
-1/2" 13-24mm
-Hex 5-19mm
L 40 & 75mm
-L163mm
-6-32mm

TTX6311

TTPS09E

Inhoud
-servicetray

TTX00

**SET
215**

TT3592 TTAF32 TT1215AF TTHR81

Inhoud
-5/16"-3/4"
-1/4" : 3/16"
-1/2"
3/8" : 3/8"
-3/4"
-1/2" : 3/8" - 1
1/4"
-2,4-4,8mm
-L300-450-550mm

TTXPB3A

**SET
926**

SET 188	SET 215	SET 491	SET 632	SET 721	SET 926
TCMM188SV 801008532	TCMM215SV 801008540	TCMM491SV 801200742	TCMM632SV 801008556	+	 TCW807SV
TCMM188N 801008529	TCMM215N 801008537	TCMM491NE 122400104	TCMM632N 801008553	+	 TCW807N
TCMM188NO 801008530	TCMM215NO 801008538	TCMM491NO 801200749	TCMM632NO 801008554	+	 TCW807NO
TCMM188NS 801008531	TCMM215NS 801008539	TCMM491NS 801200746	TCMM632NS 801008555	+	 TCW807NS
 TCW808N			TCMM632808N 801008557	TCMM721808N 801008560	
 TCW810N			TCMM632810N 801008558	TCMM721810N 801008561	TCMM926810N 801008565
 TCW806LN				TCMM721806N 801008563	TCMM926806N 801008567
 TCW809N				TCMM721809N 801008564	TCMM926809N 801008568

**TENGTOLS**

Gereedschapsset bestaande uit 188, 215, 491, 632, 721 of 926 gereedschappen.

Order nr.	Orig. nr.	Type wagen	Aantal stuks	Prijs €
801008532	TCMM188SV	TCW807SV	188	1.009,00
801008529	TCMM188NE	TCW807N	188	1.099,00
801008530	TCMM188NO	TCW807NO	188	1.129,00
801008531	TCMM188NS	TCW807NS	188	1.129,00
801008540	TCMM215SV	TCW807SV	215	1.189,00
801008537	TCMM215N	TCW807N	215	1.269,00
801008538	TCMM215NO	TCW807NO	215	1.289,00
801008539	TCMM215NS	TCW807NS	215	1.289,00
801200742	TCMM491SV	TCW807SV	491	1.329,00
122400104	TCMM491N	TCW807N	491	1.399,00
801200749	TCMM491NO	TCW807NO	491	1.425,00
801200746	TCMM491NS	TCW807NS	491	1.425,00
801008556	TCMM632SV	TCW807SV	632	1.379,00
801008553	TCMM632N	TCW807N	632	1.459,00
801008554	TCMM632NO	TCW807NO	632	1.479,00
801008555	TCMM632NS	TCW807NS	632	1.479,00
801008557	TCMM632808N	TCW808N	632	1.499,00
801008558	TCMM632810N	TCW810N	632	1.539,00
801008560	TCMM721808N	TCW808N	721	1.669,00
801008561	TCMM721810N	TCW810N	721	1.709,00
801008563	TCMM721806N	TCW806LN	721	2.335,00
801008564	TCMM721809N	TCW809N	721	2.389,00
801008565	TCMM926810N	TCW810N	926	2.039,00
801008567	TCMM926806N	TCW806LN	926	2.675,00
801008568	TCMM926809N	TCW809N	926	2.709,00

Orig. nr.	Order nr.	Lade	188	215	491	632	721	926	Omschrijving
TT1435	03490109	1	✓	✓	✓	✓	✓	✓	35-delige metrische doppenet 1/4"
TT3819	03520103	1	✓	✓	✓	✓	✓	✓	19-delige metrische doppenet 3/8"
TT1205	03570108	1	✓	✓	✓	✓	✓	✓	5-delige doppenet accessoires 1/2"
TT12176	03570256	1	✓	✓	✓	✓	✓	✓	17-delige metrische doppenet 1/2" 6-kant
TTX1292	73190100	1	✓	✓	✓	✓	✓	✓	Momentsleutel 1/2 40-210Nm
TTHT28	128250107	2	✓	✓	✓	✓	✓	✓	28-delige hex & Tx-set
TT1236	27560101	2	✓	✓	✓	✓	✓	✓	12-delige set met metrische steekringsleutels
TT6208	03900107	2	✓	✓	✓	✓	✓	✓	8-delige metrische steeksleutelset
TT6508R	109730101	2	✓	✓	✓	✓	✓	✓	8-delige ratel-steekringsleutel Tc-tray
TTX2032	68910108	2	✓	✓	✓	✓	✓	✓	7-delige metrische steeksleutelset
TTX00	101030203	3	✓	✓	✓	✓	✓	✓	Ledige TX-tray lang model
TTD912TXN	174380105	3	✓	✓	✓	✓	✓	✓	12-delige schroevendr. TX-set
TTD914N	174370106	3	✓	✓	✓	✓	✓	✓	14-delige schroevendr. Pl-ph-pz TTD-tray
710G	177710308	3	✓	✓	✓	✓	✓	✓	Breekmes
TTHEX7	68930106	4	✓	✓	✓	✓	✓	✓	7-delige metrische T-hendelset
TTTX7	68920107	4	✓	✓	✓	✓	✓	✓	7-delige TX/TPX T-handvat torxset
TT474-7	04030102	4	✓	✓	✓	✓	✓	✓	4-delige circlips tangenset
TT440-T	109820101	4	✓	✓	✓	✓	✓	✓	4-delige tangenset
TTXF05	128440104	4	✓	✓	✓	✓	✓	✓	5-delige vijlenset
TTPS09E	117060103	5	✓	✓	✓	✓	✓	✓	9-delige basis-tools set (DIN1041-hamer)
TTX00	101030203	5	✓	✓	✓	✓	✓	✓	Ledige TX-tray lang model
TTD02T299	161800310	6	✓	✓	✓	✓	✓	✓	299-delig assortiment geïsoleerde kabelschoenen
TTMD74	144030103	6	✓	✓	✓	✓	✓	✓	74-delige bitsset met ratel
TTM03	109460105	6	✓	✓	✓	✓	✓	✓	3-delige inspectieset Tc-tray
VES1000	100072188	6	✓	✓	✓	✓	✓	✓	Kabelschoenkrimptang
TTX00	101030203	6	✓	✓	✓	✓	✓	✓	Ledige TX-tray lang model
TTPC09	69220101	7	✓	✓	✓	✓	✓	✓	9-delige beitel- en doorslagset Tc-tray
TTID20	102100104	7	✓	✓	✓	✓	✓	✓	20-delige slagschroevendr. set 1/2
TTMD12D	128650108	7	✓	✓	✓	✓	✓	✓	12-delige set lange bitsen+handv.
TTV907N	178710109	7	✓	✓	✓	✓	✓	✓	7-delige schroevendraaierset 1000V
TTX01	109450106	7	✓	✓	✓	✓	✓	✓	Ledige TX-tray met 6-vak verdeling
TTV440	117490102	8	✓	✓	✓	✓	✓	✓	4-delige tangenset 1000V
TTTD17	69190106	8	✓	✓	✓	✓	✓	✓	17-delige tappen- en snijkussenset
TTBS35	132150103	8	✓	✓	✓	✓	✓	✓	35-delige dop- en bitsset 1/4
TTTX30	102140100	8	✓	✓	✓	✓	✓	✓	30-delige torx set 1/4-3/8 Tx,TPX,Tx-E
TTXPB3	100690106	8	✓	✓	✓	✓	✓	✓	3-delige koevoetset 300-400-500mm
TT804	03980109	9	✓	✓	✓	✓	✓	✓	4-delige polietrekkrersset
TT9116	68800101	9	✓	✓	✓	✓	✓	✓	Slagdoppen 1/2" 6-kant
TTHEX23	68850106	9	✓	✓	✓	✓	✓	✓	23-delige bitsen Hex
TTNF12	128430105	9	✓	✓	✓	✓	✓	✓	12-delige set naaldvijlen
TTX6311	68910157	9	✓	✓	✓	✓	✓	✓	11-delige ringsleutels Tx-tray 6-32mm
TT3592	58050303	10	✓	✓	✓	✓	✓	✓	8-delige steekringsleutels AF 8
TTAF32	68610104	10	✓	✓	✓	✓	✓	✓	32-delige doppenet AF
TT1215AF	03570306	10	✓	✓	✓	✓	✓	✓	15-delige doppenet 1/2" AF
TTHR81	69210102	10	✓	✓	✓	✓	✓	✓	81-delige riveteerset Tc-tray
TTXPB3A	117860106	10	✓	✓	✓	✓	✓	✓	3-delige barenset universeel

EVA MASTER TOOLSET 231 - 333 - 278

SET 231

SET 333

SET 278

TTEMB11
11 dlg
Tangen

TTEX32
32 dlg
Stkr. 8-32mm
Ratelslkr. 8-19mm
L. 250mm

TTEPS12
12 dlg.
Service tray

TTEMD98N
98 dlg.
Plat, PH, PZ - 1000V

TTESK77
77 dlg.
1/4" 4-13mm &
6-13mm
3/8" 8-22mm
1/2" 10-24mm
1/2" impact 13-24mm

TTEX17
17 dlg.
Hex 2,5-8mm
TX 10-40
1/2" 40-200Nm

TTESK85
85 dlg.
1/4" TX10-40, PH0-3,
Plat, PZ1-3
3/8" TX/TPX 10-50,
TXE 10-18, hex 3-12
1/2" TX 20-60, hex
5-12, Ribe 4-13,
spl 5-16

TTEMD122N
122 dlg.
Plat, PH, PZ, TX,
TPX, Hex

TTEMB17
17 dlg.
Tangen

TTESP31
31 dlg.
5,5 - 38mm

TTEX23
23 dlg.
Hex 2,5-8mm
TX 10-40
5-13mm

TTESK86
86 dlg.
1/4" 4-13mm
3/8" 7-22mm

Order nr.	Orig. nr.	231	333	278	Omschrijving
178870101	TTEX32	✓	✓		32-delige sleutel & vijlenset
178830105	TTEPS12	✓	✓		12-delige basistoolset
178840104	TTESK77	✓	✓		77-delige doppen- en acc. 1/4, 3/8 & 1/2
178810107	TTEMB11	✓	✓		11-delige tangenset
186160107	TTEMD98N	✓	✓		98-delige schroevendraaier- & bitsset
178810107	TTEX17		✓		17-delige hex sleutel & inspectieset
178850103	TTESK85		✓		85-delige doppen & bitsset
186200101	TTEMD122N			✓	122-delige schroevendraaier- & bitset
161720107	TTEMB17			✓	17-delige tangenset
161750104	TTESP31			✓	86-delige doppen- en acc. 1/4" & 3/8" & accessoires 4-22mm
161770102	TTEX23			✓	23-delige T-sleutel- & doppen- en schroevendraaier- & bitsset
161680103	TTESK86			✓	31-delige steekring- & doppen- en bitsset 5,5-38mm

	SET 231	SET 333	SET 278	
TC805NFX +	TCEM231NFX 801201232		TCEM278NFX 801202781	
	TCEM231806 801201238		TCEM278806 801202786	+ TCW806N1
TCW807N +	TCEM231N 801201233	TCEM333N 801201333	TCEM278N 801202780	
	TCEM231NO 801201236	TCEM333NO 801201336	TCEM278NO 801202782	+ TCW807NO
TCW807NS +	TCEM231NS 801201237	TCEM333NS 801201337	TCEM278NS 801202783	
	TCEM331SV 801201234	TCEM333SV 801201334	TCEM278SV 801202785	+ TCW807SV

PRIJS TOOLSET IS INCL. GEREEDSCHAPSWAGEN

EVA Master Toolset 231-333-278.

Set "EVA foam trays" bestaande uit 1 wagen en tangenset 11dlg EVA-tray, schroevendraaier- & bitsset 98dlg EVA-tray, sleutel & vijlenset 32dlg EVA-tray, steekringsleutels: 8-32mm, ringsleutels, basistools 12dlg EVA-tray en Doppenset & acc. 1/4, 3/8 & 1/2 77dlg EVA-tray.

Order nr.	Orig. nr.	Type wagen	Toolset	Prijs €
801201232	TCEM231NFX	TC805NFX	231	1.289,00
801201238	TCEM231806	TCEM806N	231	1.425,00
801201233	TCEM231N	TCW807N	231	1.419,00
801201236	TCEM231NO	TCW807NO	231	1.475,00
801201237	TCEM231NS	TCW807NS	231	1.475,00
801201234	TCEM231SV	TCW807SV	231	1.315,00
801201334	TCEM333SV	TCW807SV	333	1.789,00
173790106	TCEM333N	TCW807N	333	1.899,00
801201336	TCEM333NO	TCW807NO	333	1.925,00
801201337	TCEM333NS	TCW807NS	333	1.929,00
801202781	TCEM278NFX	TC805NFX	278	1.319,00
801202786	TCEM278806	TCW806N	278	1.439,00
801202785	TCEM278SV	TCW807SV	278	1.349,00
801202780	TCEM278N	TCW807N	278	1.449,00
801202782	TCEM278NO	TCW807NO	278	1.469,00
801202783	TCEM278NS	TCW807NS	278	1.505,00

Gereedschapsets

BT411L



108-delige dop- & dopbitsset 1/4"-1/2" bestaande uit 21 korte en lange doppen 1/4", 24 korte en lange doppen 1/2", 18 dopbitsen 1/4", 16 bitsen 5/16", TX doppen 1/4" en 1/2", ratel 1/2" en 1/4" 48 tanden en accessoires 1/4" en 1/2". Verpakt in een kunststof koffer.

- Aantal stuks 108
- Doppen 1/4" 4 - 4,5 - 5 - 5,5 - 6 - 7 - 8 - 9 - 10 - 11 - 12 - 13 - 14 mm
- Doppen 1/4" lang mm 6 - 7 - 8 - 9 - 10 - 11 - 12 - 13 mm
- Doppen 1/2" 10 - 11 - 12 - 13 - 14 - 15 - 16 - 17 - 18 - 19 - 20 - 21 - 22 - 24 - 27 - 30 - 32 mm
- Doppen 1/2" lang 14 - 15 - 16 - 17 - 19 - 21 - 22 mm
- Dopbitsen 1/4" Hex 3 - 4 - 5 - 6 mm - plat 4mm - 5,5 - 6,5 mm - PH1 - PH2 - PZ1 - PZ2 - TX8 - TX10 - TX15 - TX20 - TX25 - TX27 - TX30
- E-TX doppen 1/4" E4 - E5 - E6 - E7 - E8
- E-TX doppen 1/2" Aantal tanden E10 - E11 - E12 - E14 - E16 - E18 - E20 - E22
- Ratel 1/4" 48 tanden
- Ratel 1/2" 48 tanden
- T-baar 1/4" 1
- Verlengstukken 1/4" mm 50 - 100
- Verlengstukken 1/2" mm 125 - 250
- Kniekoppeling 1/4"
- Allensleutels mm 1,27 - 1,5 - 2 - 2,5
- Bitsen 5/16" Hex 8mm - Hex 10mm - Hex 12mm - Hex 14mm - Plat 8 - 10 - 12mm - PH3 - PH4 - PZ3 - PZ4 - TX40 - TX45 - TX50 - TX55 - T60
- Bitshouder 1/4" mm 60
- Bitshouder met handvat

Order nr.		855006916
Orig. nr.		BT42108
Gewicht	kg	6,80
Afmetingen (l x b x h)	mm	410 x 310 x 95
Prijs	€	64,90

METALWORKS



NEW

99-delige toolset in 5 delige metalen koffer. Deze set bevat doppen 1/2" 13-24mm + accessoires, magnetische bitshouder, 43-delige bitsset, steekringsleutels 6-22mm, 8 schroevendraaiers plat en PH, combinatietang, zijknijptang, waterpomptang, griptang, beitelse, hamer, handzaag, rolmeter en handlamp.

- Doppen 1/2": 10 - 13 - 14 - 16 - 17 - 18 - 19 - 20 - 22 - 24 mm
- Bougiedoppen 1/2": 16 - 21mm
- Ratel 1/2": 72 tanden
- Verlengstuk: 125 - 250 mm; Universele koppeling 1/2"; Adaptor: 1/2" (F) - 3/8" (M);
- Steekringsleutels: 6 - 7 - 8 - 9 - 10 - 11 - 12 - 13 - 14 - 15 - 16 - 17 - 18 - 19 - 20 - 22 mm
- Bitsset met handvat: plat 3(x2) - 4(x2) - 5(x2) - 6(x2) - 7(x2) mm, PH 0(x2) - 1(x2) - 2(x2) - 3(x2), PZ 0(x2) - 1(x2) - 2(x2) - 3(x2), TX 10 - 15 - 20 - 25 - 27 - 30, HEX 2 - 2,5 - 3 - 4 - 5 - 5,5 - 6, vierkant 0 - 1 - 2 - 3;
- Magnetische bitshouder: 1/4";
- Combinatietang: 7"; Zijknijptang: 6"; Griptang: 7"; Waterpomptang: 10";
- Schoevendraaiers: PH2x38 - PH0x75 - PH1x75 - PH2x100 - PL6.5x38 - PL3.0x75 - PL5.5x75 - PL6.5x100 mm;
- Beitelse: pen 3mm, doorslag 8mm, drevell 6mm, ritsbeitel 5mm, koudbeitel 13mm;
- Hamer: 300g; Rolmeter : 3m; Handzaag: 10"; Handlamp

Order nr.		855006919
Orig. nr.		BTK99A
Aantal stuks		99
Gewicht	kg	6,80
Prijs	€	129,00



INDUSTRIAL QUALITY
Chrome Vanadium Steel

NEW

91-delige gereedschapskoffer voor de vakman met full chrome vanadium gereedschap. Bestaande uit 3 tangen, 1 cutter, basis-HSS borenset, 1 mini-beugelzaag, 4 plat/Pz schroevendraaiers, 1 set ballpoint-allensleutels, 7 steekringsleutels 8-17mm, 1 ratel en 11 doppen 3/8" van 9 tot 20mm, 1 schroefsleutel 200mm, 1 bitshouder, bits-ratelhandvat en 31 bitsen 1/4", 1 bankhamer 300g, 1 rolmeter 3.5m. Verpakt in een stevige alu-koffer.

Order nr.	855006908	
Orig. nr.	BTK91A	
Aantal stuks	91	
Draagbaar	✓	
Allensleutels	mm	2,5 - 3 - 4 - 5 - 6 - 8 - 10
Bankhamer	g	300
Rolmeter	3,5m x 12mm	
Kniekoppeling	mm	3/8" + adapt. 3/8"(F) - 1/4"(M)
Schroefsleutels	mm	200 (8")
Tangen	langebektang 160mm, kniptang 160mm, platte bektang 180mm	
Schroevendraaiers	Plat 6,5x100mm - Plat 5x75mm - PH1x75mm - PH2x100mm	
Bitsen 1/4"	PH0 - PH1 - PH2 - PH3 - PH4 - PZ0 - PZ1 - PZ2 - PZ3 - PZ4 - T10 - T15 - T20 - T25 - T27 - T30 - Plat 3mm - Plat 4mm - Plat 4,5mm - Plat 5mm - Plat 5,5mm - Plat 6mm - Plat 7mm - H1,5 - H2 - H2,5 - H3 - H4 - H5 - H6	
Bitshouder 1/4"	mm	60
Bitshouder - rateltype	ratelmodel	
Mes	1	
Mini beugelzaag	mm	150
Doppen 3/8"	mm	9 - 10 - 11 - 12 - 13 - 14 - 16 - 17 - 18 - 19 - 20
Ratel 3/8" aantal tanden	45	
Verlengstukken 3/8"	mm	75 - 150
Steekringsleutels	8 - 10 - 11 - 12 - 13 - 14 - 17	
Borenset	HSS-Ti (2mm - 3mm - 4mm - 5mm - 6mm - 8mm) - beton (4mm - 5mm - 6mm - 8mm - 10mm) - hout (4mm - 5mm - 6mm - 8mm - 10mm)	
Alu koffer	mm	365x265x120
Gewicht	kg	6,70
Prijs	€	109,00

METALWORK



INDUSTRIAL QUALITY

Chrome Vanadium Steel

NEW

134-delige gereedschapskoffer voor de vakman met full chrome vanadium gereedschap. Bestaande uit 3 tangen 160/180mm, 1 schaar, 1 waterpomptang, 1 schrijnwerkerstang, 1 vijl L. 250mm, 1 cutter, 1 mini-beugelzaag, 4 plat/Pz schroevendraaiers en 1 mini-schroevendraaier/testlamp, 1 set ballpoint-allensleutels, 9 steekringsleutels 8-22mm, 1 ratel en 13 doppen 1/4" van 4 tot 14mm, 1 ratel en 13 doppen 1/2" van 10 tot 32mm met accessoires, 1 schroefleutel 250mm, 1 beitel- en doorslagenset, 1 bitshouder en 20 bitsen plat, Ph, Pz, Tx, hex, 1 mini-bitshouder en 10 mini-bitsen, 1 bankhamer 300g, 1 rolmeter 5m, combi-circlipstang, Led-werkklamp, kabelschoenen en -tang, waterpas L. 300mm, schuifmaat L. 150mm. Verpakt in een stevige alu-koffer.

Order nr.	855006913	
Orig. nr.	BTK134A	
Aantal stuks	134	
Doppen 1/4"	mm	4 - 4,5 - 5 - 5,5 - 6 - 7 - 8 - 9 - 10 - 11 - 12 - 13 - 14
Doppen 1/2"	mm	10 - 13 - 14 - 16 - 17 - 18 - 19 - 20 - 22 - 24 - 27 - 30 - 32
T-baar 1/4"	1	
Verlengstukken 1/4"	mm	50 - 100
Verlengstukken 1/2"	mm	125 - 250
Allensleutels	mm	1,5 - 10
Steekringsleutels	mm	8 - 10 - 11 - 12 - 13 - 14 - 17 - 19 - 22
Rolmeter	5m x 3/4"	
Doppen 1/2" lang	mm	16 - 21
Ratel 1/4" aantal tanden	48	
Ratel 1/2"	48	
T-baar 1/2"	1	
Kniekoppeling	mm	1/4" - 1/2"
Schroefleutels	mm	250 (10")
Tangen	langebektang 160mm, kniptang 160mm, platte bektang 180mm, HD kniptang 180mm - waterpomptang 240mm	
Circlipstang	combitang met 4 klauwen	
Schrijnwerkerskniptang	mm	250 Cr-V (10")
Schroevendraaiers	Plat 6,5x100mm - Plat 5x75mm - PH1x75mm - PH2x100mm	
Bitsen 1/4"	PH1 - PH2 - PH3 - PH4 - PZ1 - PZ2 - PZ3 - PZ4 - T10 - T15 - T20 - T25 - T30 - T40 - Plat 5,5mm - Plat 6mm - Plat 8mm - H4 - H5 - H6	
Bitset - minitypes	Plat 1mm - Plat 1,5mm - Plat 2mm - Plat 2,5mm - Plat 3mm - Plat 3,5mm - Plat 4mm - PH0 - PH00 - PH000	
Bitshouder 1/4"	mm	60
Autotester	V	100 - 250
Aantal kabelschoenen	40	
Vijlen	half rond	
Waterpas	mm	300
Werkklamp	aluminium model met lamp	
Meellat	mm	150
Beitelse	5 dlg. 4mm pen, 1 centerpunt, 1 doorslag 3mm, 1 beitel 5 en 12mm	
Bankhamer	mm	300
Mini beugelzaag	mm	150
Gewicht	kg	13,00
Prijs	€	199,00



68-delige gereedschapskoffer -type VDE 1000V - voor de kwaliteitsbewuste electricier. Bestaande uit 1 ratel en 13 doppen 1/4" van 4 tot 14mm, 1 ratel en 9 doppen 1/2" van 10 tot 22mm en accessoires, 1 set allensleutels 1.5-8mm, 9 steekringsleutels 8 - 17mm, 5 tangen VDE 1000V, langebektang, kniptang, platte bektang, waterpomptang, ontmanteltang, 6 precisieschroevendraaiers, en 6 schroevendraaiers VDE 1000V Ph en Plat, 1 bankhamer 300gr, 1 rolmeter 5m. Opgeborgen in een stevige ABS koffer.

Order nr.		855006917
Orig. nr.		BTK68VA
Aantal stuks		68
Doppen 1/4"	mm	4 - 4,5 - 5 - 5,5 - 6 - 7 - 8 - 9 - 10 - 11 - 12 - 13 - 14
Doppen 1/2"	mm	10 - 13 - 14 - 16 - 17 - 18 - 19 - 20 - 22
T-baar 1/4"		1
T-baar 1/2"	mm	50 - 100
Verlengstukken 1/4"	mm	100
Verlengstukken 1/2"	mm	125 - 250
Kniekoppeling		1/4" - 1/2"
Allensleutels	mm	1,5 - 2 - 2,5 - 3 - 4 - 5 - 6 - 8
Steekringsleutels	mm	8 - 9 - 10 - 11 - 12 - 13 - 14 - 16 - 17
VDE-tangen 1000V		langebektang 160mm - kniptang 160mm - platte bektang 160mm - waterpomptang 225mm - ontmanteltang 160mm
Precisieschroevendraaiers		PH00x50mm - PH0x50mm - PH1x50mm - Plat 1,5x50mm - Plat 2x50mm - Plat 3x50mm
VDE-schroevendraaiers 1000V		Plat 2,5x75mm - Plat 4x100mm - Plat 5,5x125mm - PH0x60mm - PH1x80mm - PH2x100mm
Bankhamer	g	300
Rolmeter		5m x 3/4"
Gewicht	kg	9,00
Prijs	€	179,00



359-delige gereedschapset in gereedschapswagen 7 laden.

Lade 1:

- Doppenset 1/2": 10-32mm 17 st., verlengstukken: 125-250mm, T-bar, ratel en elleboogstuk
- Doppenset 1/4": 4-14mm 13st., verlengstukken: 50-100mm, T-bar, ratel, elleboogstuk, dop- en dopbitsschroevendraaier met vierkante aansluiting
- Doppenset 1/4": 5-13mm 9 st., dopbitsen: 8 - 10 - 15 - 20 - 25 - 27 - 30 - 40, PH: 1 - 2 - 3, Plat (mm) 4 - 5,5 - 7, Hex (mm): 3 - 4 - 5 - 6 - 7 - 8, 10 allensleutels met bolkop: 1,5-10mm

Lade 2:

- Allensleutels met T-hendel bolkop 6 st. (mm): 6x150 - 5x150 - 4x150 - 3x100 - 2.5x100 - 2x100
- 17 steekringsleutels: 6-22mm
- 10 dubbele steeksleutels: 6-7mm - 8-9mm - 10-11mm - 12-13mm - 14-15mm - 16-17mm - 18-19mm - 20-22mm - 24-27mm - 30-32mm

Lade 3:

- Allen sleutels en geïsoleerde schroevendraaiers: Plat (mm) 3x75 - 4x100 - 5.5x125 - 6.5x150, PH: 1x100 - 2x100, Plat (mm) 1,8, 2, 2,4, 3, precisieschroevendraaiers PH: 0 - 00 - 1, Plat (mm): 2 - 2.5 - 3 - 4 - 5 - 6 - 8 en allensleutels
- Torx schroevendraaiers: 10x75 - 15x75 - 20x100 - 25x100 - 27x100 - 30x125 - 40x150 (mm)
- Schroevendraaiers Plat (mm): 6x38 - 6x100 - 6x150 - 5x100, PH: 2x38 - 1x100 - 3x150

Lade 4:

- Combinatietang: 200mm, kniptang: 180mm, lange bektang: 200mm
- Waterpomptang: 250mm en griptang: 250mm
- Bankhamer: 40mm - 500gr, hamer met nylon en rubber kop: 500g - 40mm

Lade 5:

- Kabelschoenset: 200 kabelschoenen, 1 kabelkrimptang
- 4 Circlipstangen
- Lege tray



Order nr.		855006950
Orig. nr.		BTK359W
Aantal stuks		359
Gewicht	kg	70,00
Afmetingen (l x b x h)	mm	790 x 490 x 101
Prijs	€	549,00

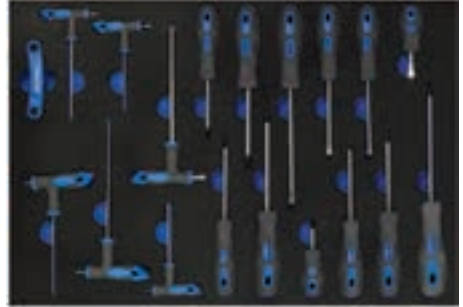

Gereedschapswagen met 6 laden, inclusief 160 gereedschappen verdeeld in de vier bovenste laden. Veiligheidspal op elke lade en een centraal sleutelslot. 2 van 4 wielen in swivel design voor een eenvoudige bediening en voorzien van een rem. De gereedschappen in de laden worden geplaatst op twee gekleurde EVA-blokken met elk tool profiel cut-outs. Het is dan ook eenvoudig te controleren dat alles in orde is.

Set bevat

- steekringsleutels : 6-22mm
- ratelsteekringsleutels : 10-19mm
- dubbele flex ringsleutel : 10-17mm
- doppen, 1/4 4-14mm, 1/4 TX ext. E4-E8, 1/2 8-32mm, 1/2 TX ext. E10-E24
- verlengstuk 1/4 en 1/2, 1/4 en 1/2
- ratel
- bitsen : plat 4-6mm, PH, PZ, HEX, TX
- 1/2 bougiedop 16 en 21mm
- schuifmaat 150mm
- rolmeter 5m
- hamer 500 gr
- vijlen
- tangen
- T-sleutels TX10-TX30, Hex 1,5-6mm
- schroevendraaiers Stubby, plat, PH
- accessoires

Order nr.		165350109
Orig. nr.		FCMM160
Aantal stuks		160
Gewicht	kg	76,00
Afmetingen (l x b x h)	mm	780 x 678 x 459
Prijs	€	789,00

Trays in tool storage



Teng Tools zorgt voor overzicht en netheid op de werkvloer

Waarom een warboel in uw gereedschapsset, als Teng Tools ervoor kan zorgen dat dit overzichtelijk is?

Als een van de beste gereedschapsproducenten in de wereld, bieden wij u een volledig systeem om uw werkplek op orde te krijgen.

Het Teng Tools systeem biedt overzicht, zodat ieder stuk gereedschap op de juiste plaats ligt, wat zorgt voor een efficiënte manier van werken. In plaats van alles door elkaar in een lade of koffer zoals het vroeger was.

Elk gereedschap, in aparte trays, die door een zwaluwstaart systeem aan elkaar verbonden worden, perfect passend in elke lade van uw Teng Tools kist of gereedschapswagen. Geen verlies van ruimte, elk stuk perfect op zijn plaats, in 1 overzicht ziet u wat welk gereedschap ontbreekt.

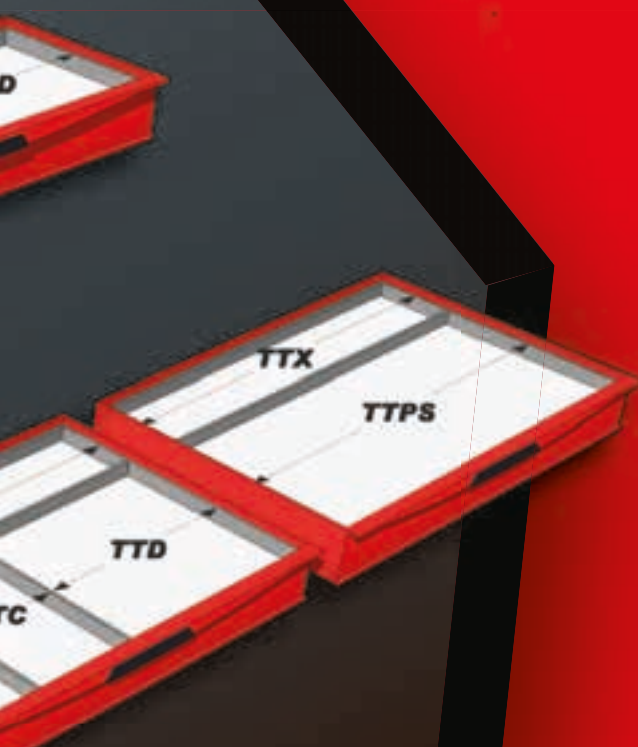

TTX (560x110x50mm)



TTPS (560x260x50mm)



EVA (1120x370x50mm)



TTD (260x280x50mm)



TC (265x142x50mm)





Gereedschap in PS trays

TENGOOLS



Kunststof opbergkoffer. Voor de Teng TC trays. Geschikt voor 3 Tc trays. Met presentatievoorbeelden.

Order nr.	114640105
Orig. nr.	TC-3
Gewicht	kg 1,40
Afmetingen (l x b x h)	mm 470 x 320 x 65
Prijs	€ 21,50

TENGOOLS



Opbergvakje met 2 alu-rails (L.260mm) en 3x10 doppenclips (1/4", 3/8", 1/2"). Met rubbermat op de bodem. TC-tray.

Order nr.	03890100
Orig. nr.	TTALU
Afmetingen (l x b x h)	mm 265 x 142 x 50
Prijs	€ 11,90

TENGOOLS



Leeg opbergvakje. Met universele houder voor schroevendraaiers of sleutels. TC-tray.

Order nr.	04160107
Orig. nr.	TT00
Afmetingen (l x b x h)	mm 265 x 142 x 50
Prijs	€ 7,30

TENGOOLS



Leeg opbergvakje met vakverdeling. TC-tray.

Order nr.	04160206
Orig. nr.	TT01
Afmetingen (l x b x h)	mm 265 x 142 x 50
Prijs	€ 8,10

TENGOOLS



Leeg opbergvakje met vakverdeling. TC-tray.

Order nr.	161790100
Orig. nr.	TT02
Afmetingen (l x b x h)	mm 265 x 142 x 50
Prijs	€ 8,10

TENGOOLS



Leeg opbergvakje met vakverdeling. TC-tray.

Order nr.	161790209
Orig. nr.	TT03
Afmetingen (l x b x h)	mm 265 x 142 x 50
Prijs	€ 8,10

TENGOOLS



Leeg opbergvakje met vakverdeling. TC-tray.

Order nr.	161790308
Orig. nr.	TT04
Afmetingen (l x b x h)	mm 265 x 142 x 50
Prijs	€ 8,10

TENGOOLS



Leeg TTX-opbergvakje met rubbermat op de bodem. TTX-tray.

Order nr.	101030203
Orig. nr.	TTX00
Afmetingen (l x b x h)	mm 570 x 110 x 40
Prijs	€ 9,10

TENGOOLS



Leeg TTX-opbergvakje met vakverdeling. TTX-tray.

Order nr.	109450106
Orig. nr.	TTX01
Afmetingen (l x b x h)	mm 570 x 110 x 40
Prijs	€ 10,50

TENGOOLS



Leeg TTX-opbergvakje met vakverdeling. TTX-tray.

Order nr.	161780101
Orig. nr.	TTX02
Afmetingen (l x b x h)	mm 560 x 110 x 40
Prijs	€ 10,50

TENGOOLS



Leeg TTX-opbergvakje met vakverdeling. TTX-tray.

Order nr.	161780200
Orig. nr.	TTX03
Afmetingen (l x b x h)	mm 560 x 110 x 40
Prijs	€ 10,50

TENGOOLS



Leeg opbergvakje met vakverdeling. DTC-tray.

Order nr.	161800107
Orig. nr.	TTD00
Afmetingen (l x b x h)	mm 260 x 280 x 50
Prijs	€ 13,50

TENGOOLS



Leeg opbergvakje met vakverdeling. DTC-tray.

Order nr.	161800206
Orig. nr.	TTD01
Afmetingen (l x b x h)	mm 260 x 280 x 50
Prijs	€ 13,50

TENGOOLS



Leeg opbergvakje met vakverdeling. DTC-tray.

Order nr.	161800305
Orig. nr.	TTD02
Afmetingen (l x b x h)	mm 260 x 280 x 50
Prijs	€ 13,50

TENGOOLS



9-delige basisset met 2 schroefsleutels, griptang 250mm, beugelzaag, universeel breekmes, soft-hamer, rolmeter, stalen meetlat en bolkophamer. PS-tray.

Order nr.	106210107
Orig. nr.	TTPS09
Afmetingen (l x b x h)	mm 570 x 262 x 56
Prijs	€ 116,00

TENGOOLS



9-delige basisset met 2 schroefsleutels, griptang 250mm, beugelzaag, universeel breekmes, soft-hamer, rolmeter, stalen meetlat en DIN1041 hamer. PS-tray.

Order nr.	117060103
Orig. nr.	TTPS09E
Afmetingen (l x b x h)	mm 570 x 262 x 56
Prijs	€ 99,00

TENGOOLS



35-delige set bestaande uit 11 korte en 6 lange doppen 1/4", 11 bitsen 1/4", ratel, elleboogstuk, bitshouder, 2 verlengstukken, adaptor 3/8"- 1/4" en bitsschroevendraaier. TC-tray.

Order nr.	03490109		
Orig. nr.	TT1435		
Aantal stuks	35		
Doppen 1/4"	mm	4 - 5 - 5,5 - 6 - 7 - 8 - 9 - 10 - 11 - 12 - 13	
Doppen 1/4" lang	mm	6 - 7 - 8 - 9 - 10 - 12 - 13	
Bitsen 1/4" plat	mm	0,8x4 - 1,2x5	
Bitsen 1/4" PH		1 - 2	
Bitsen 1/4" PZ		1 - 2	
Bitsen 1/4" TPX		10 - 15 - 20	
Bitsen 1/4" Hex	mm	5 - 6	
Afmetingen (l x b x h)	mm	265 x 142 x 50	
Prijs	€	49,90	

TENGOOLS



19-delige set bestaande uit 13 korte doppen 3/8", ratel, adaptor 1/2"-3/8", elleboogstuk, bitshouder, verlengstuk 75mm en schroevendraaier voor doppen 3/8". TC-tray.

Order nr.	03520103		
Orig. nr.	TT3819		
Aantal stuks	19		
Doppen 3/8"	mm	8 - 9 - 10 - 11 - 12 - 13 - 14 - 15 - 16 - 17 - 18 - 19 - 22	
Afmetingen (l x b x h)	mm	265 x 142 x 50	
Prijs	€	59,90	

TENGOOLS



16-delige set van lange doppen 3/8" 6-kant. Satijn afwerking. TC-tray.

Order nr.	144300100		
Orig. nr.	TT3816		
Doppen 3/8" lang	mm	7 - 8 - 9 - 10 - 11 - 12 - 13 - 14 - 15 - 16 - 17 - 18 - 19 - 20 - 21 - 22	
Afmetingen (l x b x h)	mm	265 x 142 x 50	
Prijs	€	39,90	

TENGOOLS



Set van 32 gewone en lange AF doppen 1/4" en 3/8" 6-kant. TC-tray.

Order nr.	68610104		
Orig. nr.	TTAF32		
Aantal stuks	32		
Doppen 1/4"	inch	3/16 - 7/32 - 1/4 - 9/32 - 5/16 - 11/32 - 3/8 - 7/16 - 1/2	
Doppen 1/4" lang	inch	3/16 - 7/32 - 1/4 - 9/32 - 5/16 - 11/32 - 3/8 - 7/16 - 1/2	
Doppen 3/8"	inch	3/8 - 7/16 - 1/2 - 9/16 - 5/8 - 11/16 - 3/4	
Doppen 3/8" lang	inch	3/8 - 7/16 - 1/2 - 9/16 - 5/8 - 11/16 - 3/4	
Afmetingen (l x b x h)	mm	265 x 142 x 50	
Prijs	€	39,00	

TENGOOLS



Set van 7 speciale automotive doppen 1/2" en 3/8". TC-tray. (AT350, AT355, AT360, AT365, AT370, AT375, AT380).

Order nr.	144340106		
Orig. nr.	TTSS07		
Accessoires 3/8"	Lucht sensor dop voor Mitsubishi, Nissan, Opel, Vauxhall en VW - Vacuum switch dop - Olie dop - Offset lucht sensor sleutel		
Accessoires 1/2"	Lucht sensor dop for GM - Injector dop for M24		
Afmetingen (l x b x h)	mm	265 x 142 x 50	
Prijs	€	84,50	

TENGOOLS



5-delige set met 1/2" accessoires bestaande uit 1 ratel 1/2", 2 verlengstukken L. 125 en 250mm, 1 elleboogstuk en 1 adaptor 1/2"- 3/8". TC-tray.

Order nr.	03570108		
Orig. nr.	TT1205		
Afmetingen (l x b x h)	mm	265 x 142 x 50	
Prijs	€	54,90	

TENGOOLS



17-delige set bestaande uit 12 doppen 1/2" 12-kant gaande van 10 tot 24mm, 1 ratel 1/2", 2 verlengstukken L. 62,5 en 150mm, 1 adaptor 1/2"-3/8" en 1 elleboogstuk. TC-tray.

Order nr.	39180104	39180203
Orig. nr.	TT1218	TT12186
Aantal stuks	17	17
Type dop	12-kant	6-kant
Doppen 1/2"	mm	10 - 11 - 12 - 13 - 14 - 15 - 16 - 17 - 18 - 19 - 22 - 24
Afmetingen (l x b x h)	mm	265 x 142 x 50
Prijs	€	68,50

TENGTTOOLS



Set van 20 korte en lange bitsen Hex met aansluiting Hex 10mm en 12mm. Geleverd met 1 hexschroevendraaier, 1 dopbitshouder 1/2" - 10mm en 1 dopbitshouder 1/2" - 12mm. TC-tray.

Order nr.	68850106		
Orig. nr.	TTHX23		
Bits 10mm, lengte 40mm	mm	5 - 6 - 7 - 8 - 9 - 10	
Bits 12mm, lengte 40mm	mm	12 - 14 - 17 - 19	
Bits 10mm, lengte 75mm	mm	5 - 6 - 7 - 8 - 9 - 10	
Bits 12mm, lengte 75mm	mm	12 - 14 - 17 - 19	
Adaptor 1/2"	mm	10-12	
Schroevendraaier Hex	mm	2	
Afmetingen (l x b x h)	mm	242 x 165 x 50	
Prijs	€	41,50	

TENGTTOOLS



11-delige set met 10 lange doppen 1/2" 12-kant en 1 handvat 1/2" met flexibele aansluiting 250mm. TC-tray.

Order nr.	122090103		
Orig. nr.	TT1211		
Doppen 1/2" lang	mm	10 - 11 - 12 - 13 - 14 - 15 - 16 - 17 - 18 - 19	
Afmetingen (l x b x h)	mm	265 x 142 x 50	
Prijs	€	56,50	

TENGTTOOLS



Set van 17 MM-doppen 1/2" 6- of 12-kant gaande van 10 tot 32mm. De AF-set bestaat uit 15 doppen 1/2" 12-kant en gaat van 3/8" tot 1 1/4". TC-tray.

Order nr.	03570207	03570256	03570306
Orig. nr.	TT1217	TT12176	TT1215AF
Aantal stuks	17	17	15
			3/8 - 7/16 - 1/2 - 9/16 - 5/8 - 11/16 - 3/4 - 13/16 - 7/8 - 15/16 - 1 - 1 1/16 - 1 1/8 - 1 3/16 - 1 1/4
Doppen 1/2" 12-kant	inch		
Doppen 1/2" 6-kant	mm	10 - 11 - 12 - 13 - 14 - 15 - 16 - 17 - 18 - 19 - 20 - 21 - 22 - 24 - 27 - 30 - 32	
Doppen 1/2"	mm	10 - 11 - 12 - 13 - 14 - 15 - 16 - 17 - 18 - 19 - 20 - 21 - 22 - 24 - 27 - 30 - 32	
Afmetingen (l x b x h)	mm	265 x 142 x 50	265 x 142 x 50
Prijs	€	41,90	41,90

TENGTTOOLS



17dlg set adaptors 1/4", 3/8", 1/2", 3/4" bithouders.

Order nr.	185800109		
Orig. nr.	TTADP17		
Adaptor M/F	3/8x1/2 - 1/2x3/8 - 3/4x1/8 - 1/4x3/8 - 3/8x1/4 - 1/2x3/4 - 1x3/4		
Bitshouder magnetisch	1/4 50mm - 1/4 70mm		
Bitshouder met snelspankop	1/4 50mm		
Bitshouder	1/4		
Adaptor	3/8x 1/4 bitsen - 1/4Mx1/4 hex - 3/8M met 1/4 hex - 1/4 6-kant naar 1/2 vierkant - 1/4 6-kant naar 1/4 vierkant - 1/4 6-kant naar 3/8 vierkant		
Prijs	€	48,50	

TENGTTOOLS



Set van 20 korte en lange bitsen Tx met aansluiting Hex 10mm en 12mm. Geleverd met 1 hexschroevendraaier, 1 dopbitshouder 1/2" - 10mm en 1 dopbitshouder 1/2" - 12mm. TC-tray.

Order nr.	68860105		
Orig. nr.	TTTX23		
Schroevendraaier Hex	mm	2	
Bits 10mm, lengte 40mm TX		20 - 25 - 27 - 30 - 40 - 45 - 50 - 55	
Bits 12mm, lengte 40mm TX		60 - 70	
Bits 10mm, lengte 75mm TX		20 - 25 - 27 - 30 - 40 - 45 - 50 - 55	
Bits 12mm, lengte 75mm TX		60 - 70	
Dopbits houder 1/2"	mm	10 - 12	
Afmetingen (l x b x h)	mm	265 x 142 x 50	
Prijs	€	39,00	

TENGTTOOLS



30-delige set bestaande uit 18 dopbitsen 1/4" en 3/8" TX en TPX en 10 doppen 3/8" E-tx. Geleverd met adaptor 3/8"-1/4" en 1 verlengstuk 3/8" L.75mm. TC-tray.

Order nr.	102140100		
Orig. nr.	TTX30		
Dopbitsen 3/8" TX		10 - 15 - 20 - 25 - 27 - 30 - 40 - 45 - 50	
Dopbitsen 3/8" TPX		10 - 15 - 20 - 25 - 27 - 30 - 40 - 45 - 50	
Doppen 1/4" E		4 - 5 - 6 - 7 - 8	
Doppen 3/8" E		10 - 12 - 14 - 16 - 18	
Afmetingen (l x b x h)	mm	265 x 142 x 50	
Prijs	€	62,90	

TENGOOLS



35-delige set. Van dopbitsen 1/4" en 3/8" Plat, Ph, Pz, Tx en Hex met een adaptor 3/8"-1/4" en 1/4"-3/8". TC-tray.

Order nr.	132150103		
Orig. nr.	TTBS35		
Dopbitsen 1/4" plat	mm	4 - 4,5 - 7	
Dopbitsen 1/4" PH		0 - 1 - 2 - 3	
Dopbitsen 1/4" PZ		1 - 2 - 3	
Dopbitsen 1/4" TX		10 - 15 - 20 - 25 - 27 - 30 - 40	
Dopbitsen 3/8" Hex	inch	1/8 - 5/32 - 3/16 - 7/32 - 1/4 - 5/16 - 3/8	
Afmetingen (l x b x h)	mm	265 x 142 x 50	
Prijs	€	41,90	

TENGOOLS



15-delige set bestaande uit 15 dopbitsen 1/2" RIB en SPL L.100mm. TC-tray.

Order nr.	143880102		
Orig. nr.	TTRS15		
Dopbitsen 1/2" RIB	mm	4 - 5 - 6 - 8 - 10 - 11 - 12 - 13	
Dopbitsen 1/2" SPL	mm	5 - 6 - 8 - 10 - 12 - 14 - 16	
Afmetingen (l x b x h)	mm	265 x 142 x 50	
Prijs	€	65,90	

TENGOOLS



Set van 15 lange (L.100mm) dopbitsen 1/2" TX en Hex. Gaande van TX20 tot TX60 en Hex 5 tot 12mm. TC-tray.

Order nr.	118890102		
Orig. nr.	TTXH15		
Aantal stuks	15		
Dopbitsen 1/2" TX		20 - 25 - 27 - 30 - 40 - 45 - 50 - 55 - 60	
Dopbitsen 1/2" Hex	mm	5 - 6 - 7 - 8 - 10 - 12	
Afmetingen (l x b x h)	mm	265 x 142 x 50	
Prijs	€	61,50	

TENGOOLS



13-delige set. Bestaande uit 6 verlengstukken 1/4", 3/8" en 1/2", 3 elleboogstukjes 1/4", 3/8" en 1/2", 1 adaptor 3/8"-1/4", 1 T-handvat en 2 mini-schroevendraaiers Hex 2.0 en 2.5mm. Met het korte en lange verlengstuk kan een T-hendel worden gemaakt dankzij de opening in de aansluitingskant. Het T-handvat dient als handgreep op het korte verlengstuk. TTX-tray.

Order nr.	68870104		
Orig. nr.	TTXEXT13		
Verlengstukken 1/4"	mm	150-300	
Verlengstuk 3/8"	mm	75-500	
Verlengstukken 1/2"	mm	75-500	
Afmetingen (l x b x h)	mm	560 x 110 x 40	
Prijs	€	78,00	

TENGOOLS



9-delige lange doppen set met een T-staaf. 3/8" aansluiting. TTX tray.

Order nr.	178791109		
Orig. nr.	TTXTB09		
Doppen 3/8"	mm	8, 10, 12, 13, 14, 17, 19	
T-baar	mm	300	
Afmetingen (l x b x h)	mm	560 x 110 x 40	
Prijs	€	72,00	

TENGOOLS



5-delige set van flex-bougiedoppen 3/8". Met opening voor T-hendel. Met T-baar. TTX-tray. Handvat uit kunststof.

Order nr.	178801007		
Orig. nr.	TTXTB05		
Doppen 3/8"	mm	14 - 16 - 21	
Handvat lengte	mm	520	
Afmetingen (l x b x h)	mm	560 x 110 x 40	
Prijs	€	63,50	

TENGOOLS



4-delige set bestaande uit 1 ratel 3/4" 40-tands, 1 vaste T-hendel 3/4" en 2 verlengstukken 3/4" L. 200 en 400mm. TTX-tray.

Order nr.	101530103		
Orig. nr.	TTX3404		
Afmetingen (l x b x h)	mm	570 x 110 x 70	
Prijs	€	132,00	

TENGOOLS



Set van 14 doppen 3/4" gaande van 19 tot 50mm (6-kant) of van 7/8" tot 1 7/8" voor de AF-set (12-kant). TTX-tray.

Order nr.	101540102		101540201	
Orig. nr.	TTX3414		TTX34AF	
Doppen 3/4" 6-kant	mm	19 - 21 - 22 - 24 - 27 - 30 - 32 - 33 - 34 - 36 - 38 - 41 - 46 - 50		
Doppen 3/4"	inch	7/8 - 15/16 - 1 - 1 1/16 - 1 1/8 - 1 3/16 - 1 1/4 - 1 5/16 - 1 3/8 - 1 7/16 - 1 1/2 - 1 5/8 - 1 3/4 - 1 7/8		
Afmetingen (l x b x h)	mm	570 x 110 x 74		
Prijs	€	111,00		116,00

TENGOOLS



Set van 10 stubby (korte) steekringsleutels gaande van 10 tot 19mm. De ringkant heeft een hellingshoek van 15°. TC-tray.

Order nr.	109470104		
Orig. nr.	TT6010M		
Aantal stuks	10		
Steekringsleutels	mm	10 · 11 · 12 · 13 · 14 · 15 · 16 · 17 · 18 · 19	
Afmetingen (l x b x h)	mm	256 x 142 x 50	
Prijs	€	46,50	

TENGOOLS

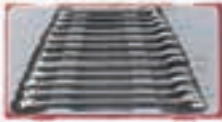

Set van 12 steekringsleutels gaande van 8 tot 19mm. TC-tray.

Order nr.	27560101		
Orig. nr.	TT1236		
Aantal stuks	12		
Sleutels	mm	8 · 9 · 10 · 11 · 12 · 13 · 14 · 15 · 16 · 17 · 18 · 19	
Afmetingen (l x b x h)	mm	265 x 142 x 50	
Prijs	€	45,90	

TENGOOLS



Set van 8 steekringsleutels AF gaande van 5/16" tot 3/4". De ringkant heeft een hellingshoek van 15°. Identieke maten aan beide kanten van de sleutel. TC-tray.

Order nr.	58050303		
Orig. nr.	TT3592		
Aantal stuks	8		
Steekringsleutels		5/16 · 3/8 · 7/16 · 1/2 · 9/16 · 5/8 · 11/16 · 3/4	
Afmetingen (l x b x h)	mm	265 x 142 x 50	
Prijs	€	39,90	

TENGOOLS



Set van 7 steekringsleutels gaande van 20 tot 32mm of van 13/15" tot 1 1/4" voor de AF-set. De ringkant heeft een hellingshoek van 15°. Identieke maten aan beide kanten van de sleutel. TTX-tray.

Order nr.	68910108	68910207
Orig. nr.	TTX2032	TTX2640
Aantal stuks	7	7
Maat	inch	13/16 · 7/8 · 15/16 · 1 · 1 1/8 · 1 1/4
Maat	mm	20 · 21 · 22 · 24 · 27 · 30 · 32
Afmetingen (l x b x h)	mm	560 x 110 x 40
Prijs	€	77,90

TENGOOLS



Set van 12 lange steekringsleutels met dezelfde maat aan beide uiteinden. Ringkant 12-kant met hellingshoek 15°. Geleverd in een TTX-tray die geschikt is voor de Teng Tools koffers en gereedschapswagens.

Order nr.	185870102		
Orig. nr.	TTXUMP12		
Aantal stuks	12		
Maten	mm	8 · 9 · 10 · 11 · 12 · 13 · 14 · 15 · 16 · 17 · 18 · 19	
Prijs	€	58,90	

TENGOOLS



Set van 8 ratel-steekringsleutels gaande van 8 tot 19mm of van 5/16" tot 3/4" voor de AF-set. Identieke maten aan beide kanten van de sleutel. Ringkant 12-kant met hellingshoek 15° en handige omschakelknop voor het wijzigen van de draairichting. Aktiehoek 5°. TC-Tray.

Order nr.	109730101	109730200
Orig. nr.	TT6508R	TT6508RAF
Aantal stuks	8	8
Sleutels	mm	8 · 10 · 11 · 12 · 13 · 14 · 17 · 19
Ratel-steekringsleutels		5/16" · 3/8" · 7/16" · 1/2" · 9/16" · 5/8" · 11/16" · 3/4"
Afmetingen (l x b x h)	mm	265 x 142 x 50
Prijs	€	126,00

TENGOOLS



Set van 8 ratel-steekringsleutels gaande van 8 tot 19mm. Identieke maten aan beide kanten van de sleutel. Model zonder omschakelknop. Platte sleutel. TC-tray.

Order nr.	166720102		
Orig. nr.	TT6508RS		
Aantal stuks	8		
Sleutels	mm	8 · 10 · 11 · 12 · 13 · 14 · 17 · 19	
Afmetingen (l x b x h)	mm	265 x 142 x 50	
Prijs	€	99,00	

TENGOOLS



Set van 8 swivel-ratel-steekringsleutels gaande van 8 tot 19mm. Swivel-zijde is 180° klinkbaar. Identieke maten aan beide kanten van de sleutel. TC-tray.

Order nr.	131900102		
Orig. nr.	TT6508RF		
Aantal stuks	8		
Ratel-steekringsleutels		8 · 10 · 11 · 12 · 13 · 14 · 17 · 19	
Afmetingen (l x b x h)	mm	265 x 142 x 50	
Prijs	€	115,00	

TENGOOLS



11-delige ratel-steekringsleutel set. Vervaardigd uit hoogwaardig chroom vanadium staal. Matverchroomd. Identieke maten aan beide uiteinden. Ringkant 12-kant met hellingshoek 15° en handige omschakelknop voor het wijzigen van de draairichting. Actiehoek 5°.



Order nr.	186740106		
Orig. nr.	TT6511R		
Aantal stuks	11		
Maten	mm	8, 9, 10, 11, 12, 13, 14, 15, 16, 17, 19	
Prijs	€	158,00	

TENGOOLS



Set van 11 dubbele ringsleutels gaande van 6 tot 32mm. TTX-tray.

Order nr.	68910157		
Orig. nr.	TTX6311		
Aantal stuks	11		
Ringsleutels	mm	6x7 - 8x9 - 10x11 - 12x13 - 14x15 - 16x17 - 18x19 - 20x22 - 21x23 - 24x27 - 30x32	
Afmetingen (l x b x h)	mm	560 x 110 x 40	
Prijs	€	93,00	

TENGOOLS



Set van 8 dubbele steeksleutels gaande van 6 tot 22mm. Chroom vanadium staal. TC-tray.

Order nr.	03900107		
Orig. nr.	TT6208		
Steeksleutels	mm	6x7 - 8x9 - 10x11 - 12x13 - 14x15 - 16x17 - 18x19 - 20x22	
Afmetingen (l x b x h)	mm	265 x 142 x 50	
Prijs	€	31,90	

TENGOOLS



Set van 6 dubbele flex-ringsleutels 12-kant gaande van 8 tot 19mm. Verschillende maten aan beide kanten. TC-tray.

Order nr.	73000101		
Orig. nr.	TT6506		
Aantal stuks	6		
Sleutels	mm	8x9 - 10x11 - 12x13 - 14x15 - 16x17 - 18x19	
Prijs	€	70,90	

TENGOOLS

NEW



7-delige open pijpringsleutelset. Speciaal ontworpen om pijp- en slangkoppelingen te openen en aan te spannen. Ideaal voor beperkte ruimtes zoals hydraulische toepassingen. De ring ratel is eenvoudig te openen. 12-kant.

Order nr.	186780102		
Orig. nr.	TTXQRS07		
Maat	mm	13 14 16 22 24 27 32	
Prijs	€	209,00	

TENGOOLS



Pijpsleutelset gebogen 7dlg. In TC-tray.

Order nr.	118400100		
Orig. nr.	TTAW07		
Aantal stuks	7		
Maat	mm	8 10 12 13 14 17 19	
Prijs	€	49,90	

TENGOOLS



Set van 6 dubbele ratel-ringsleutels 12-kant gaande van 6 tot 22mm. TC-tray.

Order nr.	116700105		
Orig. nr.	TTRORS		
Aantal stuks	6		
Ringsleutels	mm	6x8 - 7x9 - 10x13 - 12x14 - 17x19 - 21x22	
Afmetingen (l x b x h)	mm	265 x 142 x 50	
Prijs	€	46,50	

TENGOOLS



Set van 3 haakpinsleutels met 3 pin adaptors en 2 extra pinnen van 6 en 8mm. TC-tray.

Order nr.	102120102		
Orig. nr.	TTHP08		
Haakpinsleutels voor diameter	mm	19 - 50, 30 - 75, 50 - 120	
Pin adaptors met pin diameter	mm	4 - 5 - 6	
Extra pinnen diameter	mm	6 - 8	
Prijs	€	81,90	

TENGOOLS



4-delige schroefsluutelset. Met schaalverdeling. TC-tray.

Order nr.	166730101		
Orig. nr.	TTADJ04		
Capaciteit	mm	24 · 28 · 33 · 38	
Schroefsluutels	mm	150 · 200 (2x) · 250	
Afmetingen (l x b x h)	mm	265 x 142 x 50	
Prijs	€	74,00	

TENGOOLS



10-delige set bestaande uit 8 opsteek-ratelsluutels, 1 opsteek-ratelkop 3/8" en 1 opsteek-handvat 9x12mm. TC-tray.

Order nr.	118380104		
Orig. nr.	TTIG10		
Aantal stuks	10		
Ratelsluutels	mm	8 · 10 · 11 · 12 · 13 · 16 · 17 · 19	
Prijs	€	112,00	

TENGOOLS



Set van 15 doorsteekdoppen met ratel. Cap. 10-19mm. Speciaal voor het aan- en losdraaien van moeren op een lange doorgestoken schroefdraad. De doppen hebben een 3/8" aandrijving en een zeskant buitenkant maat 19mm. TC-tray.

Order nr.	143890101		
Orig. nr.	TTTH16		
Doppen 3/8" 6-kant	mm	10 · 11 · 12 · 13 · 14 · 15 · 16 · 17 · 18 · 19	
Ratel 3/8"	mm	19	
Verlengstukken 3/8"	mm	75	
Adaptors 3/8"	1 + 1 universal		
Bougiedoppen 3/8"	mm	16 · 21	
Prijs	€	77,50	

TENGOOLS



Set van 3 Teng ratels 72-tands van 1/4", 3/8" en 1/2". TC-tray.

Order nr.	128210101		
Orig. nr.	TT7203		
Aantal stuks	3		
Ratels	inch	1/4 · 3/8 · 1/2	
Afmetingen (l x b x h)	mm	265 x 142 x 50	
Prijs	€	89,50	

TENGOOLS

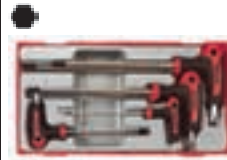

Set van 7 allensluutels met T-hendel gaande van 2.5 tot 8mm of van 3/32" tot 5/16" voor de AF-set. Met balkop aan de lange kant van de sluutel. TC-tray.

Order nr.	68930106	68930205
Orig. nr.	TTHX7	TTHX7AF
Aantal stuks	7	7
Sluutels	mm	2,5 · 3 · 4 · 5 · 6 · 7 · 8
Maat	inch	3/32 · 1/8 · 5/32 · 3/16 · 7/32 · 1/4 · 5/16
Afmetingen (l x b x h)	mm	265 x 142 x 50
Prijs	€	32,90

TENGOOLS



28-delige allensluutelset MM, AF en TX. Geleverd in 3 handige sets.

Order nr.	128250107		
Orig. nr.	TTHT28		
Maat	inch	5/64 · 3/32 · 1/8 · 5/32 · 3/16 · 7/32 · 1/4 · 5/16 (1479AF) · 3/8	
Maat	mm	1,5 · 2 · 2,5 · 3 · 4 · 5 · 6 · 8 · 10 (1479mm)	
Maat TX	8 · 9 · 10 · 15 · 20 · 25 · 27 · 30 · 40 (1479TX)		
Allensluutel met ball-point	mm	7	
Afmetingen (l x b x h)	mm	265 x 142 x 50	
Prijs	€	41,90	

TENGOOLS



Set van 7 sluutels TX/TPX met T-hendel. Gaande van TX-TPX10 tot TX-TPX40. Met TPX aan de korte kant van de sluutel. TC-tray.

Order nr.	68920107		
Orig. nr.	TTIX7		
Aantal stuks	7		
Sluutels TX	10 · 15 · 20 · 25 · 27 · 30 · 40		
Afmetingen (l x b x h)	mm	265 x 142 x 50	
Prijs	€	33,90	

TENGOOLS



74 delige set. Bevat Ratel bit schroevendraaier, 6" flexibel verlengstuk, 4" verlengstuk, 1/4" M x 1/4" hex adaptor, koppel adaptor en 69 bitsen. TC-tray.

Order nr.	144030103		
Orig. nr.	TTMD74		
Bitsen 1/4"	mm	0,6x3,5 - 0,6x4,5 - 0,8x4 - 0,8x5,5 - 1x5,5 - 1,2x5 - 1,2x6,5 - 1,4x7 - 1,6x8	
Hex aansluiting 25mm plat		1 (x4) - 2(x7) - 3	
Bitsen 1/4"		1 (x4) - 2(x7) - 3	
Hex aansluiting 25mm PZ		6 - 7 - 8 - 9 - 10 - 15 - 20 (x3) - 25 (x3) - 27 - 30 - 40	
Bitsen 1/4"		10 - 15 - 20 (x2) - 25 (x2) - 27 - 30 - 40	
Hex aansluiting 25mm TPX		2 - 3 - 4 - 5 - 6 - 8	
Bitsen 1/4"		1 - 2 - 3	
Hex aansluiting 25mm SQ		2 (x3)	
Hex aansluiting 25mm GR			
Prijs	€	37,90	

TENGOOLS



Set van 11 lange dubbelzijdige bitsen Plat, PH en PZ met een ergonomisch zwart-rood twee componenten handvat. TC-tray.

Order nr.	128650108		
Orig. nr.	TTMD12D		
Schacht PH		1x2 - 1x6,5	
Schacht Plat	mm	4,0x5,5	
Schacht PZ		1x2	
Schacht TX		10x15 - 20x25 - 30x40	
Maat Hex	mm	3x3 met bolkop, 4x4 met bolkop, 5x5 met bolkop, 6x6 met bolkop	
Prijs	€	33,50	

TENGOOLS



16-delige set bestaande uit 12 mini-schroevendraaiers Plat, Ph en Tx en 4 mini-tangen. TC-tray.

Order nr.	104450101		
Orig. nr.	TTM116		
Schroevendraaiers Plat	mm	2,0x40 - 2,4x40 - 3,0x40	
Schroevendraaiers PH	mm	00(x40) - 0(x40)	
Schroevendraaiers TX	(mm)	6 - 7 - 8 - 9 - 10 - 15	
Tang kopknip	mm	114	
Zijkniptang	mm	125	
Lange bektang	mm	125	
Prijs	€	62,90	

TENGOOLS



Set van 14 schroevendraaiers plat, PH en PZ in Teng TTD tray. Met een ergonomisch zwart-rood twee componenten handvat.

Order nr.	174370106		
Orig. nr.	TTD914N		
Schroevendraaiers Plat	mm	0,5x3x75 - 0,6x3,5x100 - 1,0x5,5x75 - 1,2x6,5x38 - 1,0x5,5x125 - 1,2x6,5x100	
Schroevendraaiers PH	mm	0(x75) - 1(x75) - 2(x38) - 2(x100)	
Schroevendraaiers PZ	(mm)	0(x75) - 1(x75) - 2(x38) - 2(x100)	
Afmetingen (l x b x h)	mm	265 x 142 x 50	
Prijs	€	53,90	

TENGOOLS



Set van 12 schroevendraaiers TX in Teng TTD tray. Met een ergonomisch zwart-rood twee componenten handvat.

Order nr.	174380105		
Orig. nr.	TTD912TXN		
Schroevendraaiers TX	mm	6(x75) - 7(x75) - 8(x75) - 9(x75) - 10(x100) - 15(x100) - 20(x100) - 25(x100) - 27(x100) - 30(x100) - 40(x100) - 45(x100)	
Afmetingen (l x b x h)	mm	265 x 142 x 50	
Prijs	€	49,90	

TENGOOLS

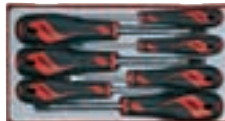

Set van 7 schroevendraaiers plat, PH en PZ. TT-MV PLUS staal. Ergonomisch twee componenten handvat met ophanggat. TC tray.

Order nr.	174400101		
Orig. nr.	TT917N		
Schroevendraaiers Plat	mm	0,5x3x75 - 1x5,5x75 - 0,2x6,5x100	
Schroevendraaiers PH	mm	0x75 - 1x75 - 2x75	
Schroevendraaiers PZ	mm	2x100	
Prijs	€	27,90	

TENGOOLS

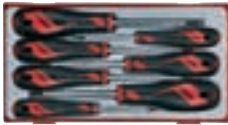

Set van 7 TX/TPX schroevendraaiers. TT-MV PLUS staal. Ergonomisch twee componenten handvat met ophanggat. TC tray.

Order nr.	174410100		
Orig. nr.	TT917TXN		
Schroevendraaiers TX	(mm)	8(x75) - 9(x75)	
Schroevendraaiers TPX	(mm)	10(x100) - 15(x100) - 20(x100) - 25(x100) - 30(x100)	
Afmetingen (l x b x h)	mm	265 x 142 x 50	
Prijs	€	27,90	

TENGOOLS



5-delige schroevendraaiers set plat en PH waarvan 2 stubby. TTX-tray.

Order nr.	174500108		
Orig. nr.	TTX918N		
Schroevendraaiers Plat	mm	1,2x6,5x38 - 0,5x3x100	
Schroevendraaiers PH	mm	1,2x6,5x100 - 1,6x10x200 - 1,0x5,5x150 - 1,2x8x150	
Prijs	€	46,50	

TENGOOLS



5-delige set power-thru schroevendraaiers set plat en PH met zeskant schacht en slagdop. TTX-tray.

Order nr.	174490102		
Orig. nr.	TTXMDTN		
Schroevendraaiers Plat	mm	1,2x6,5x100 - 1,2x8,0x150 - 1,6x10x200	
Schroevendraaiers PH	mm	2x100 - 3x150	
Afmetingen (l x b x h)	mm	560 x 110 x 40	
Prijs	€	37,90	

TENGOOLS



Set van 7 1000V-schroevendraaiers plat, PZ en PH in Teng TC tray, bestaande uit 3 platte schroevendraaiers, 3 PH Schroevendraaiers en 1 PZ schroevendraaier. Met geïsoleerde handgreep en schacht. TC-tray.

Order nr.	178710109		
Orig. nr.	TTV907N		
Schroevendraaiers Plat	mm	2,5x75 - 4x100 - 5,5x125	
Schroevendraaiers PH	mm	0(x60) - 1(x80) - 2(x100)	
Schroevendraaiers PZ	(mm)	2(x100)	
Afmetingen (l x b x h)	mm	265 x 142 x 50	
Prijs	€	30,90	

TENGOOLS



Set van 10 schroevendraaiers 1000-V plat, PH en PZ in TTD tray.

Order nr.	174390104		
Orig. nr.	TTDV910N		
Schroevendraaiers Plat	mm	0,4x2,5x75 - 0,5x3,0x100 - 0,8x4,0x100 - 1,0x5,5x125	
Schroevendraaiers PH		0 - 1 - 2	
Schroevendraaiers PZ		0 - 1 - 2	
Afmetingen (l x b x h)	mm	265 x 142 x 50	
Prijs	€	38,90	

TENGOOLS



Set van 9 Mega Drive schroevendraaiers op dop 6-kant gaande van 5 tot 13mm. Met een ergonomisch zwart-rood twee componenten handvat. TTX-tray.

Order nr.	114590102		
Orig. nr.	TTXMDN		
Maten	mm	5 - 5,5 - 6 - 7 - 8 - 10 - 11 - 12 - 13	
Prijs	€	68,90	

Gereedschap in trays

TENGOOLS



Set van 4 Mega Bite tangen bestaande uit 1 waterpomptang 250mm, 1 zijknijptang 150mm, 1 lange bektang 200mm en 1 combinatietang 175mm. Met zwart-rode vinyl-beklede anti-slip handvaten. TC-tray.

Order nr.	44280105
Orig. nr.	TT440
Prijs	€ 62,90

TENGOOLS



Set van 4 Mega Bite tangen bestaande uit 1 waterpomptang 250mm, 1 zijknijptang 150mm, 1 lange bektang 200mm en 1 combinatietang 175mm. Met een ergonomisch zwart-rood twee-componenten TPR-handvat. TC-tray.

Order nr.	109820101
Orig. nr.	TT440-T
Afmetingen (l x b x h)	mm 265 x 142 x 50
Prijs	€ 59,90

TENGOOLS



8-delige tangenset. Bestaat uit 2 extra zware zijknijptangen, 2 combinatietangen, 2 lange bektangen, 2 waterpomptangen. Met rode vinyl-beklede anti-slip handvat en TTD-tray.

Order nr.	174350108
Orig. nr.	TTD441
Zijknijptang	mm 150 - 200
Combinatie tangen	mm 150 - 200
Lange bektang	mm 150 - 200
Waterpomptangen	mm 175 - 250
Afmetingen (l x b x h)	mm 280 x 280 x 50
Prijs	€ 105,00

TENGOOLS



Set van 8 tangen. Twee waterpomptangen (175 en 200), twee combinatietangen (150 en 200), twee zijknijptangen (150 en 200) en twee platbektang (150 en 200). Chroom-molybdeen staal. Ergonomisch twee componenten handvat. TTD tray.

Order nr.	174360107
Orig. nr.	TTD441-T
Afmetingen (l x b x h)	mm 280 x 280 x 50
Prijs	€ 112,00

TENGOOLS



Set van 4 geïsoleerde 1000V tangen klasse EN 60900 bestaande uit 1 zijknijptang, 1 lange bektang, 1 kabelstriptang en 1 combinatietang. Geïsoleerde kunststof handgrepen. TC-tray.

Order nr.	117490102
Orig. nr.	TTV440
Zijknijptang	mm 150
Combinatie tangen	mm 175
Lange bektang	mm 200
Ontmanteltang	mm 175
Prijs	€ 65,90

TENGOOLS



Set van 4 circlipstangen L.125mm bestaande uit 1 recht inwendig, 1 recht uitwendig, 1 gebogen inwendig en 1 gebogen uitwendig model. TC-tray.

Order nr.	112520101
Orig. nr.	TT474-5
Circlips tangen	mm 10x25 - Recht inwendig 10x25 - Gebogen inwendig 10x25 - Recht uitwendig 10x25 - Gebogen uitwendig 10x25
Prijs	€ 41,50

TENGOOLS



Set van 4 circlipstangen L.175mm bestaande uit 1 recht inwendig, 1 recht uitwendig, 1 gebogen inwendig en 1 gebogen uitwendig model. TC-tray.

Order nr.	04030102
Orig. nr.	TT474-7
Circlips tangen	mm 12x65 - recht inwendig 12x65mm - gebogen inwendig 12x65mm - recht uitwendig 12x65mm - gebogen uitwendig 12x65mm
Prijs	€ 47,90

TENGOOLS



Set van 4 circlipstangen L.225mm. TTX-tray.

Order nr.	112700109
Orig. nr.	TTX474-9
Tangen circlips recht inwendig	mm 32x80
Tangen circlips gebogen inwendig	mm 32x80
Tangen circlips recht uitwendig	mm 32x80
Tangen circlips gebogen uitwendig	mm 32x80
Afmetingen (l x b x h)	mm 265 x 142 x 50
Prijs	€ 72,00

TENGOOLS



Set van 5 griptangen bestaande uit 3 ronde bek en 2 lange bek. TC-tray.

Order nr.	122480106
Orig. nr.	TTVG05
Klassieke griptangen	mm 100 - 175 - 250
Griptangen lange dunne bekken	mm 100 - 150
Prijs	€ 55,00

TENGOOLS



Set van 4 griptangen bestaande uit 1 C-bek 250mm (type 406), 1 platte bek 200mm (type 408), 1 gebogen bek 225mm (type 407) en 1 lange bek type 160mm (type 404). Geleverd in een PVC tray. PS-tray.

Order nr.	106230105
Orig. nr.	TTPSPG
Prijs	€ 55,90

TENGOOLS



39-delige set bestaande uit 1 moment schroevendraaier 1/4", 1 verlengstuk L. 100mm, 1 bitshouder 1/4" en 36 verschillende bits. Nauwkeurigheid +/- 6%.

Order nr.	122500101
Orig. nr.	TTS39
Bitsen	Plat 0,5x3mm - Plat 0,6x4,5mm - Plat 0,8x5,5mm - Plat 1,2x6,5mm - PH0 - PH1 - PH2 - PH3 - PZ0 - PZ1 - PZ2 - PZ3 - TX8 - TX9 - TX10 - TX15 - TX20 - TX25 - TX27 - TX30 - TX40 - TPX10 - TPX15 - TPX20 - TPX30 - TPX40 - Rob 0 - Rob 1 - Rob 2 - Rob 3 - PH GR 2(2) - Hex 2mm - Hex 3mm - Hex 4mm - Hex 5mm - Hex 6mm
Momentschroevendraaier 1/4"-Hex voor	Nm 1.5
Prijs	€ 96,90

TENGOOLS



Set van 1 momentsleutel 1/2". 1292AG-EP. Richting omkeerbaar dmv hendel maar enkel rechtshandig voor instellen moment. TTX Tray.

Order nr.	73190100
Orig. nr.	TTX1292
Aansluiting	inch 1/2
Capaciteit	Nm 40-200
Prijs	€ 70,90

TENGOOLS



22-delige set bestaande uit 1 momentsleutel 3/8", 10 opsteeksleutels, 8 bitsen TX, 1 bitshouder en 2 verlengstukken 3/8" L. 75 en 125mm. Geleverd in een Teng tray geschikt voor elke Teng gereedschapskoffer of -wagen. TTX-tray.

Order nr.	102110104
Orig. nr.	TTX3892
Aansluiting	inch 3/8
Bitsen TX	8 - 10 - 15 - 20 - 25 - 27 - 30 - 40
Verlengstukken 3/8"	mm 75 - 125
Opsteeksleutels	mm 10 - 11 - 12 - 13 - 14 - 15 - 16 - 17 - 18 - 19
Bereik	Nm 20-100
Afmetingen (l x b x h)	mm 570 x 110 x 60
Prijs	€ 112,00

TENGOOLS



Set. Bestaande uit 1 momentsleutel 1/2" 40-200Nm en 1 krachtvermeerderaar 1/2"-3/4" 1400Nm. TTX-tray.

Order nr.	128220100
Orig. nr.	TTXMP12
Inkomende aansluiting	inch 1/2
Krachtvermeerderaar	Nm 1400
Momentsleutel 1/2"	Nm 40-200 (max. 200x3 met momentsleutel in deze set)
Uitgaande aansluiting	inch 3/4
Prijs	€ 329,00

TENGOOLS



5-delige set bestaande uit 3 lange slagdoppen 1/2" van 17, 19 en 21mm, 1 tang 240mm voor montage van balancergewichten en 1 momentsleutel 1/2". TTX-tray.

Order nr.	122490105
Orig. nr.	TTXW05
Momentsleutel 1/2"	Nm 40-210Nm
Tang balancergewichten	mm 240
Slagdoppen 1/2"	mm 17 - 19 - 21
Afmetingen (l x b x h)	mm 570 x 110 x 40
Prijs	€ 105,00

TENGOOLS



24-delige slagdoppenset. Bestaat uit 24 slagdoppen gaande van 6 tot 19mm waarvan 5 korte slagdoppen 1/4", 9 korte slagdoppen 3/8", 9 lange slagdoppen 3/8" en 1 adaptor 3/8"-1/4". TC-Tray.

Order nr.	132470105		
Orig. nr.	TT9024		
Doppen 3/8"	mm	8 - 10 - 11 - 12 - 13 - 14 - 15 - 16 - 17 - 19	
Doppen 1/4"	mm	6 - 7 - 8 - 10 - 13	
Doppen 3/8" lang	mm	8 - 10 - 11 - 12 - 13 - 14 - 15 - 16 - 17 - 19	
Adaptor	inch	3/8 - 1/4	
Prijs	€	59,50	

TENGOOLS



Set van 16 korte en lange slagdoppen 1/2" gaande van 13 tot 24mm, 2 vasthoudpinnen en 2 O-ringen. Conform DIN-standaard. TC-tray.

Order nr.	143840106		
Orig. nr.	TT9120D		
Doppen 1/2" 6-kant	mm	13 - 15 - 16 - 17 - 18 - 19 - 22 - 24	
Doppen 1/2" 6-kant lang	mm	13 - 15 - 16 - 17 - 18 - 19 - 22 - 24	
Vasthoudpinnen	mm	20X3,5 - 25X3,5	
O-ringen	mm	3x20 - 3x24	
Prijs	€	80,90	

TENGOOLS



16-delige korte en lange doppenset 1/2" ANSI gaande van 13 tot 24mm. TC-Tray.

Order nr.	68800101		
Orig. nr.	TT9116		
Doppen 1/2"	mm	13 - 15 - 16 - 17 - 18 - 19 - 22 - 24	
Doppen 1/2" lang	mm	13 - 15 - 16 - 17 - 18 - 19 - 22 - 24	
Prijs	€	59,90	

TENGOOLS



Set van 15 hex slagdoppen 3/8" en 1/2" gaande van 4 tot 19mm. TC-tray.

Order nr.	151410107		
Orig. nr.	TT9015HX		
Dopbitsen 1/2" Hex	mm	5 - 6 - 8 - 10 - 12 - 14 - 17 - 19	
Dopbitsen 3/8" hex	mm	4 - 5 - 6 - 7 - 8 - 10 - 12	
Afmetingen (l x b x h)	mm	265 x 142 x 50	
Prijs	€	98,90	

TENGOOLS



Set van 12 slagdopbitsen 1/2" gaande van TX10 tot TX70. TC-tray.

Order nr.	128130101		
Orig. nr.	TT9212TX		
Slagbitsen	TX	10 - 15 - 20 - 25 - 27 - 30 - 40 - 45 - 50 - 55 - 60 - 70	
Prijs	€	92,90	

TENGOOLS



7-delige set slagdopaccessoires 1/2" bestaande uit 3 verlengstukken, universele elleboog 1/2", 3 adaptors. TC-tray.

Order nr.	132460106		
Orig. nr.	TT9207		
Verlengstukken	mm	75 - 125 - 250	
Universele koppeling	inch	1/2	
Adaptors	inch	1/23/4 - 3/8-1/2 - 1/23/8	
Prijs	€	54,50	

TENGOOLS



Set van 15 korte en lange slagdoppen 3/4" gaande van 19 tot 36mm. TTX-tray.

Order nr.	122080104		
Orig. nr.	TTX9415		
Slagdoppen 3/4"	mm	19 - 24 - 27 - 28 - 30 - 32 - 34 - 36	
Slagdoppen 3/4" lang	mm	19 - 24 - 27 - 30 - 32 - 33 - 36	
Prijs	€	175,00	

TENGOOLS



16-delige slagdoppenset. Bestaat uit 9 korte slagdoppen gaande van 19 tot 38mm en 1 verlengstuk. TC-tray.

Order nr.	160690103		
Orig. nr.	TTD9416		
Doppen 3/4" 6-kant	mm	19 - 24 - 27 - 30 - 32 - 33 - 34 - 36 - 38	
Verlengstuk	mm	175	
Vasthoudpinnen	mm	4x37 (x2)	
O-ringen	mm	38x3,5 (x3)	
Afmetingen (l x b x h)	mm	260 x 280 x 80	
Prijs	€	108,00	

TENGOOLS



Slagmoersleutel. TTDAW12C met behuizing in composiet. TTDAW12M met een standaard behuizing. Omkeerbaar: 3-traps vooruit en 2-traps achteruit. Lichte slagmoersleutel met geluidsabsorberend vermogen. Ergonomische grip door rubberen handvat die tevens isoleert tegen koude luchtstroom en vibraties. Voorzien van een koppeling die 360° draaibaar is, om het gebruiksgemak te verhogen. Traploze trekker. Speciaal ontworpen voor professioneel gebruik.

Order nr.	168840106	
Orig. nr.	TTDAW12C	
Aansluiting	inch	1/2
Boutcapaciteit	mm	M8-M16
Toerental	tpm	8500
Maximum torsie	Nm	650
Maximum torsie (3 stappen)	Nm	650
Mechanisme twin hammer	✓	
Geluidsniveau (ISO86627)	dB(A)	97,5
Vibratie (ISO 15744:1999)	m/s ²	4,42
Minimum maat slang	inch	3/8
Luchtaansluiting	G (R)	1/4
Luchtverbruik (bij 15% interval)	l/min	133
Afmetingen (l x b x h)	mm	280 x 280 x 80
Prijs	€	195,00

TENGOOLS



20-delige set bestaande uit 1 slagschroevendraaier 1/2", bitshouder 1/2"-5/16", adaptor 3/8"M-5/16"Hex en 17 slagbitsen L.36mm. TC-tray.

Order nr.	102100104	
Orig. nr.	TTID20	
Slagbitsen Plat	mm	6 - 8 - 10 - 12
Slagbitsen PH	1 - 2 - 3 - 4	
Adaptor	inch	3/8-5/16
Slagbitsen Hex	mm	4 - 5 - 6 - 8
Slagbitsen TX	30 - 40 - 45 - 50 - 55	
Prijs	€	28,50

TENGOOLS



4-delige set bestaande uit 1 schraper, 1 priem en 2 haken. Met een ergonomisch twee componenten handvat. TC-tray.

Order nr.	117690107	
Orig. nr.	TTSR04	
Prijs	€	26,50

TENGOOLS

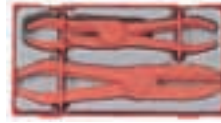

Set van 3 speciale klemtangen voor het onbeschadigd samenklemen van o.a. remleidingen. Lichte constructie. Toepasbaar voor de meest gangbare leidingen. TC-tray.

Order nr.	118420108	
Orig. nr.	TTHC03	
Aantal stuks	3	
Voor slang diameter	mm	10 - 15 - 30
Prijs	€	27,50

TENGOOLS



5-delige hamerset bestaande uit 2 terugslagvrije hamers en 3 plaatwerkhammers. Geleverd in een PVC tray. PS-tray.

Order nr.	122440100	
Orig. nr.	TTPSAD	
Diameter kop van terugslagvrije hamers	mm	35 et 55
Plaatwerkhamer	met rechte pin, met ronde puntige kop, met vierkante kop	
Gewicht	kg	5,76
Prijs	€	105,00

TENGOOLS



121-delige set bestaande uit 1 kabelschoentang CP50 voor geïsoleerde kabelschoentjes (rode, blauwe en gele) en een assortiment van 120 kabelschoentjes. TC-tray.

Order nr.	110380102	
Orig. nr.	TTCP121	
Prijs	€	26,50

TENGOOLS



4-delige set bestaande uit 1 automatische kabelschoentang met 3 klauwen voor respectievelijk geïsoleerde 22-10 AWG, niet-geïsoleerde 22-12 AWG en niet-geïsoleerde 22-8 AWG kabelschoenen. TC-tray.

Order nr.	122470107	
Orig. nr.	TTCP04	
Voor geïsoleerde kabelschoenen	mm	22-10 AWG (0,324 mm ² - 5,261 mm ²)
Voor niet geïsoleerde ADENER-hulzen	mm	22-12 AWG (0,324 mm ² - 3,31 mm ²)
Voor niet-geïsoleerde kabelschoenen	mm	22-8 AWG (0,3 mm ² - 8 mm ²)
Prijs	€	61,50



TENGOOLS



4-delige set bestaande uit 1 combinatie-poulietrekker met 3 armen maar met de mogelijkheid om de poulietrekker zowel als 2-armig of als 3-armig toestel te gebruiken. Met omkeerbare armen voor intern en extern trekken. TC-tray.

Order nr.	03980109	
Orig. nr.	TT804	
Vastklemdiepte	mm	100
Vastklembreedte	mm	130
Prijs	€	41,50

TENGOOLS



Set van 3 koevoeten. Koevoeten van verschillende lengtes en met een ronde, spitse punt aan het ene eind en een vlakke ronde haak aan het andere einde. TTX-tray.

Order nr.	100690106	
Orig. nr.	TTXPB3	
Lengte	mm	300 - 400 - 500
Prijs	€	51,50

TENGOOLS



Set van 3 priemen voorzien van een stevig handvat. Universeel toepasbaar. TTX-tray.

Order nr.	117860106	
Orig. nr.	TTXPB3A	
Lengte	mm	300 - 450 - 550
Prijs	€	39,00

TENGOOLS



16-delige universele olieserviceset bestaande uit 6 dubbele carterdoppen, 2 bougiedoppen 3/8", 1 oliefiltersleutel, 2 verlengstukken 3/8" L. 75 en 200mm, 1 adaptor 1/2"-3/8", 1 dop 3/8" 21mm, 1 telescopische inspectiepiegel met magneet en een set voelermaten. TC-tray.

Order nr.	03960101	
Orig. nr.	TTOS16	
Aantal stuks	16	
Maat carterdoppen	mm/ pouce	5/16x3/8 - 11x12 - 17x1/2 - 8x3/8 - 8x10 - 13x14
Bougiedoppen 3/8"	mm	16 - 21
Verlengstukken 3/8"	mm	75 - 250
Voelermaat, 21 bladen	mm	0,05 - 1,00
Prijs	€	59,90

TENGOOLS



11-delige set bestaande uit 5 linkse tappen, 4 moeren-extracteurs en 2 moerspijlers. TC-tray.

Order nr.	69340107	
Orig. nr.	TTSN11	
Linkse tappen	inch	7/64 - 9/64 - 5/32 - 1/4 - 19/64
Extractors	mm	6 - 8 - 10 - 12
Moerspijlers	mm	5-20, 14-27
Prijs	€	61,50

TENGOOLS



17-delige tappen- en snijkussenset. Bestaat uit 6 tappen en 6 snijkussens gaande van M3 tot M12, 1 kussenhouder, 1 taphouder en 1 draadsnijmeter. TC-tray.

Order nr.	69190106	
Orig. nr.	TTD17	
Maten	M3 - M4 - M5 - M6 - M8 - M10 - M12	
Prijs	€	47,50

TENGOOLS



10-delige flensboordset. Geschikt voor koperen, bronzen en dunwandige alu-buizen. Snijcapaciteit tot 30mm. 45° boorden van 3/16" tot 5/8" diam. Inclusief wisselmes en hendel. TC-tray.

Order nr.	144040102	
Orig. nr.	TTTF10	
Buizensnijder	mm	3 - 32
Flensboord tool	mm	3 - 4 - 5 - 6 - 8 - 10
Flensboord adaptors voor buizensdiameter	mm	4 - 4,75 - 6 - 8 - 10 - 12 - 14
Afmetingen (l x b x h)	mm	265 x 142 x 50
Prijs	€	61,00

TENGOOLS



Knipset bestaande uit 2 plaatscharen (recht/rechts (491) - recht/links (492)), een breekmes (701N), een schaar (497) en een extra-zware kabelknijptang (496 - 590mm). TTD-tray.

Order nr.	144020104
Orig. nr.	TTDCT05
Prijs	€ 73,90

TENGOOLS



Set met 5 breekmessen en 35 vervangmessen. TC-tray.

Order nr.	174480103
Orig. nr.	TTK40
Afmetingen (l x b x h)	mm 270 x 143 x 50
Prijs	€ 48,90

TENGOOLS



3-delige inspectieset met telescopische werktuigen bestaande uit 1 inspectiespiegel, 1 vergrootglas en 1 magneet. Alle 3 met een cliphouder/zakkleem. TC-tray.

Order nr.	109460105
Orig. nr.	TTTTM03
Diameter magneet	mm 12
Diameter vergrootglas/spiegel	mm 55
Afmetingen (l x b x h)	mm 265 x 142 x 50
Prijs	€ 37,90

TENGOOLS



8-delige inspectieset bestaande uit telescopische pick-up werktuigen zoals 1 flexibele klauw en 1 telescopische pick up, 1 inspectiespiegel, 1 vergrootglas, 1 LED lamp model 585. Geleverd met 2 batterijen. TC-tray.

Order nr.	144370103
Orig. nr.	TTTTM08
Lengte flexibele pickup	mm 310
Lengte telescopische pickup	mm 160-480
Afmetingen (l x b x h)	mm 265 x 142 x 50
Prijs	€ 49,90



TENGOOLS



81-delige riveteertangset bestaande uit 1 riveteertang (cap. 2,4 - 3,2 - 4,0 - 4,8mm) en een assortiment van 80 (4x20) blindrivetten. TC-tray.

Order nr.	69210102
Orig. nr.	TTHR81
Lengte	mm 250
Afmetingen (l x b x h)	mm 270 x 143 x 50
Prijs	€ 51,90

TENGOOLS



81-delige blindnietmoertangset bestaande uit 1 blindnietmoertang (cap. M3, M4, M5 en M6) en een assortiment van 80 (4x20) blindnietmoeren. TC-tray.

Order nr.	106190101
Orig. nr.	TTNR81
Afmetingen (l x b x h)	mm 265 x 142 x 50
Prijs	€ 98,90

TENGOOLS



Set van 12 naaldvijlen met de meeste courante modellen. TC-tray. Lengte 163mm.

Order nr.	128430105
Orig. nr.	TTNF12
Prijs	€ 28,50

TENGOOLS



Set van 5 handvijlen L. 250mm middelgrof bestaande uit 1 ronde, 1 halfronde, 1 vierkante, 1 driehoek en 1 platte handvijl. TTX Tray.

Order nr.	128440104
Orig. nr.	TTXF05
Prijs	€ 43,90

TENGOOLS



9-delig slagset bestaande uit 2 beitels L. 150 en 200mm, 6 doorslagen diam. 3 tot 8mm en 1 centerpunt L. 150mm. TC-tray.

Order nr.	69220101
Orig. nr.	TTPC09
Top diameter doorslagen	mm 3 - 4 - 5 - 6 - 7 - 8
Breedte beitels	mm 19 - 25
Punt diameter centerdoorslag	mm 5
Afmetingen (l x b x h)	mm 270 x 143 x 50
Prijs	€ 42,90

TENGOOLS



28-delige borenset 1-13mm per 0,5mm DIN 338 HSS snijhoek 118° bestaande uit 3 x 1.0 en 1.5mm, 2 x 2.0 en 2.5mm, 1 x 3mm tot 13mm. TC-tray.

Order nr.	151440104
Orig. nr.	TTDB28
Aantal stuks	28
Boordiameter	mm 1,0 - 13,0
Afmetingen (l x b x h)	mm 270 x 143 x 50
Prijs	€ 39,90

TENGOOLS



Torsiestafset in TC-tray. Voor het vastzetten van wielmoeren. Bevat 4 torsiestaven variërend van 90-140 Nm, 1 adaptor en 3 slagdoppen voorzien van een kunststof beschermingshuls voor gebruik bij o.a. alu-velgen.

Order nr.	172470403
Orig. nr.	TTTS08
Bitsen 1/2"	mm 17-19-21
Adaptor	inch 3/8 x 1/2
Verlengstukken	Nm 1/2" 90-110-120-140
Prijs	€ 77,90

TENGOOLS



5-delige meetset. Bestaande uit een digitale schuifmaat 150 mm, micrometer 0-25 mm, winkelhaak 150x100 mm, een stalen maatlat 150 mm en een kraspen 135 mm. Geleverd zonder batterijen (1x SR44). TC-tray.

Order nr.	167500206
Orig. nr.	TTCM05D
Aantal stuks	5
Digitale schuifmaat	mm 0-150
Micrometers	mm 0-25
Winkelhaak	mm 150x100
Maatlat	mm 150
Kraspen	mm 135
Afmetingen (l x b x h)	mm 265 x 142 x 50
Prijs	€ 115,00

Gereedschap in EVA foam trays



86-delige doppenset 1/4" en 3/8" 4-22mm en accessoires. EVA-tray.

Order nr.	161680103
Orig. nr.	TTESK86
Aantal stuks	86
Verlengstukken 3/8"	mm 75 - 125 - 150 - 250 - 500
Doppen 1/4"	mm 4 - 4,5 - 5 - 5,5 - 6 - 7 - 8 - 9 - 10 - 11 - 12 - 13
Doppen 1/4" 6-kant lang	mm 4 - 5 - 5,5 - 6 - 7 - 8 - 9 - 10 - 11 - 12 - 13
Doppen 3/8" 6-kant	mm 7 - 8 - 9 - 10 - 11 - 12 - 13 - 14 - 15 - 16 - 17 - 18 - 19 - 20 - 21 - 22
Doppen 3/8" 6-kant lang	mm 7 - 8 - 9 - 10 - 11 - 12 - 13 - 14 - 15 - 16 - 17 - 18 - 19 - 20 - 21 - 22
Verlengstukken 1/4"	mm 50 - 75 - 100 - 150 - 300
Verlengstukken met bolkop 3/8"	mm 75 - 150 - 250
Aantal tanden ratels 1/4" en 3/8"	60
Afmetingen (l x b x h)	mm 568 x 374 x 32
Prijs	€ 285,00

TENGOOLS



63-delige doppenset 1/2" 8-36mm en accessoires. EVA-tray.

Order nr.	161670104
Orig. nr.	TTESK63
Aantal stuks	63
Verlengstukken 1/2"	mm 63 - 125 - 150 - 250 - 500
Doppen 1/2" 12kant	mm 8 - 9 - 10 - 11 - 12 - 13 - 14 - 15 - 16 - 17 - 18 - 19 - 20 - 21 - 22 - 24 - 25 - 26 - 27 - 28 - 29 - 30 - 32 - 34
Doppen 1/2" 12kant lang	mm 10 - 11 - 12 - 13 - 14 - 15 - 16 - 17 - 18 - 19 - 20 - 21 - 22 - 24 - 27 - 30 - 32 - 36
Verlengstukken met bolkop 1/2"	mm 75 - 150 - 250
Flex hendel	mm 250
Aantal tanden ratel 1/2"	60
Afmetingen (l x b x h)	mm 568 x 374 x 32
Prijs	€ 279,00

TENGOOLS



Doppen en bitsset 85dlg EVA-tray.

Order nr.	178850103
Orig. nr.	TTESK85
Aantal stuks	85
Bitsen TX 1/2"	20 - 25 - 27 - 30 - 40 - 50 - 55 - 60
Bitsen Plat 1/4"	mm 4 - 5 - 5 - 7
Bitsen TX-E 3/8"	mm 10 - 12 - 14 - 16 - 18
Verlengstuk 3/8"	mm 75
Bitsen Hex 1/2"	mm 5 - 6 - 7 - 8 - 10 - 12
Bitsen RIB 1/2"	mm 4 - 5 - 6 - 8 - 10 - 12 - 13
Bitsen SPL 1/2"	mm 5 - 6 - 8 - 10 - 12 - 14 - 16
Bitsen PH 1/4"	0 - 1 - 2 - 3
Bitsen PZ 1/4"	1 - 2 - 3
Bitsen TX-E 1/4"	4 - 5 - 6 - 7 - 8
Bitsen TX 1/4"	10 - 15 - 20 - 25 - 27 - 30 - 40
Bitsen TPX 3/8"	10 - 15 - 20 - 25 - 27 - 30 - 40 - 45 - 50
Bitsen TX 3/8"	10 - 15 - 20 - 25 - 27 - 30 - 40 - 45 - 50
Bitsen Hex 3/8"	mm 3 - 4 - 5 - 5,5 - 6 - 7 - 8 - 10 - 12
Afmetingen (l x b x h)	mm 570 x 375 x 50
Prijs	€ 219,00

TENGOOLS



32-delige doppenset en accessoires 3/4" 19-50mm. EVA-tray.

Order nr.	161730106	
Orig. nr.	TTESK32	
Aantal stuks	32	
Verlengstuk 3/4"	mm	400
Doppen 3/4"	mm	19 - 21 - 22 - 24 - 27 - 30 - 32 - 33 - 34 - 36 - 38 - 41 - 46 - 50
Doppen 3/4"	inch	7/8 - 15/16 - 1 - 1 1/16 - 1 1/8 - 1 3/16 - 1 1/4 - 1 5/16 - 1 3/8 - 1 7/16 - 1 1/2 - 1 5/8 - 1 3/4 - 1 7/8
T-baar 3/4"	mm	450
Flex hendel 3/4"	mm	475
Aantal tanden ratel 3/4"	60	
Afmetingen (l x b x h)	mm	568 x 374 x 32
Prijs	€	379,00

TENGOOLS

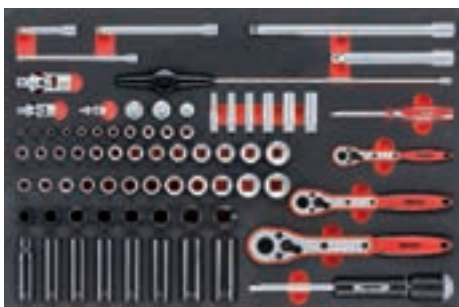

77-delige doppenset (1/4", 3/8" en 1/2"). Geleverd in een nieuw Teng Tools opslagsysteem in twee kleuren EVA verzonken schuim. Geschikt voor Teng Tools boxes en gereedschapswagens.

Order nr.	178840104	
Orig. nr.	TTESK77	
Aantal stuks	77	
Doppen 1/4" 6-kant lang	mm	6 - 7 - 8 - 10 - 12 - 13
Doppen 3/8" 6-kant	mm	8 - 9 - 10 - 11 - 12 - 13 - 14 - 15 - 16 - 17 - 18 - 19 - 22
Verlengstukken met bolkop 3/8"	mm	75 - 150
Verlengstukken met bolkop 1/2"	mm	150 - 250
Slagdoppen 1/2"	mm	13 - 15 - 16 - 17 - 18 - 19 - 22 - 24
Slagdoppen 1/2" lang	mm	13 - 15 - 16 - 17 - 18 - 19 - 22 - 24
Ratel 45 tanden	1/4" - 3/8" - 1/2"	
Universele verbindingen	1/4" - 3/8" - 1/2"	
Adaptors (reductie)	3/8"-1/4" - 1/2"-3/8"	
Adaptor (vergroter)	3/8"-1/2"	
Doppen 1/2" 6-kant	mm	10 - 11 - 12 - 13 - 14 - 15 - 16 - 17 - 18 - 19 - 22
Spinner handvatten	1/4" - 3/8"	
Verlengstukken 1/4", lengte	mm	150 - 300
Doppen 1/4" 6-kant	mm	4 - 5 - 5.5 - 6 - 7 - 8 - 9 - 10 - 11 - 12 - 13
T-handvatten	1/4"	
Afmetingen (l x b x h)	mm	570 x 375 x 75
Prijs	€	295,00



TENGOOLS



73-delige doppenset 1/2" 8-32mm en accessoires. EVA-tray.

Order nr.	161690102		
Orig. nr.	TTEISK73		
Aantal stuks	73		
Slagdoppen 1/2" 6-kant	mm	8 - 10 - 11 - 12 - 13 - 14 - 15 - 16 - 17 - 18 - 19 - 20 - 21 - 22 - 23 - 24 - 25 - 26 - 27 - 28 - 29 - 30 - 32	
Slagdoppen 1/2" 6-kant lang	mm	10 - 11 - 12 - 13 - 14 - 15 - 16 - 17 - 18 - 19 - 21 - 22 - 24 - 27 - 28 - 29 - 30 - 32	
Slagdoppen 3/8" 6-kant	mm	8 - 10 - 11 - 12 - 13 - 14 - 15 - 16 - 17 - 19	
Slagdoppen 3/8" 6-kant lang	mm	8 - 10 - 11 - 12 - 13 - 14 - 16 - 17 - 19	
Verlengstukken 1/2"	mm	75 - 125 - 250	
Verlengstukken 3/8"	mm	75 (swivel)	
Adaptors	inch	3/8-1/4 - 3/8-1/2 - 1/2-3/8 - 1/2-3/4	
Bitshouder 1/4"	inch	3/8 - 1/2	
Afmetingen (l x b x h)	mm	568 x 374 x 32	
Prijs	€	399,00	

TENGOOLS



33-delige slagdoppenset en accessoires 3/4" 19-50mm. EVA-tray.

Order nr.	161700109		
Orig. nr.	TTEISK33		
Aantal stuks	33		
Adaptors	inch	3/4-1/2 - 3/4-1	
Slagdoppen 3/4"	mm	19 - 21 - 22 - 23 - 24 - 27 - 28 - 30 - 32 - 33 - 34 - 36 - 38 - 41 - 46 - 50	
Slagdoppen 3/4" lang	mm	19 - 21 - 22 - 23 - 24 - 27 - 30 - 32 - 33 - 34 - 36 - 38 - 41 - 46 - 50	
Verlengstuk 3/4"	mm	175	
Afmetingen (l x b x h)	mm	568 x 374 x 32	
Prijs	€	487,00	

TENGOOLS



31-delige steekringsleutelset 5,5-38mm. EVA-tray.

Order nr.	161750104		
Orig. nr.	TTESP31		
Steekringsleutels	mm	5,5 - 6 - 7 - 8 - 9 - 10 - 11 - 12 - 13 - 14 - 15 - 16 - 17 - 18 - 19 - 20 - 21 - 22 - 23 - 24 - 25 - 26 - 27 - 28 - 29 - 30 - 32 - 33 - 34 - 36 - 38	
Aantal stuks	31		
Afmetingen (l x b x h)	mm	568 x 374 x 32	
Prijs	€	294,00	

TENGOOLS

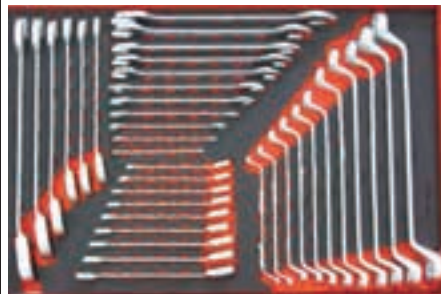

37-delige ring-, steek-, ratel-, sleutelset. 6-32mm. EVA-tray.

Order nr.	161740105		
Orig. nr.	TTESP37		
Aantal stuks	37		
Steeksleutels	mm	6x7 - 8x9 - 10x11 - 12x13 - 14x15 - 16x17 - 18x19 - 20x22 - 21x23 - 24x27 - 30x32	
Ringsleutels	mm	6x7 - 8x9 - 10x11 - 12x13 - 14x15 - 16x17 - 18x19 - 20x22 - 21x23 - 24x27 - 30x32	
Ratel-steekringsleutels	mm	8 - 9 - 10 - 11 - 12 - 13 - 14 - 15 - 16 - 17 - 18 - 19 - 22 - 24 - 27	
Afmetingen (l x b x h)	mm	568 x 374 x 32	
Prijs	€	459,00	

TENGOOLS



Sleutel en vijlenset 32dlg EVA-tray. Bestaande uit Steekringsleutel 8 tot 32mm, Ratel-steekringsleutel 8 tot 19mm, 5 Vijlen L 250mm.

Order nr.	178870101		
Orig. nr.	TTEX32		
Steekringsleutels	mm	8 - 9 - 10 - 11 - 12 - 13 - 14 - 15 - 16 - 17 - 18 - 19 - 20 - 21 - 22 - 24 - 27 - 30 - 32	
Vijlen		middelgrof: plat (2), half rond, rond en driehoek	
Platte steekringsleutels	mm	8 - 10 - 11 - 12 - 13 - 14 - 17 - 19	
Afmetingen (l x b x h)	mm	570 x 375 x 32	
Prijs	€	253,00	

TENGOOLS



62-delige doppen en steekringsleutel set. EVA-tray.

Order nr.	172320103		
Orig. nr.	TTEAF62		
Steekringsleutels	mm	5/16, 3/8, 7/16, 1/2, 9/16, 5/8, 11/16, 3/4, 13/16, 7/8, 15/16, 1, 11/16, 11/8, 1 1/4	
Doppen 1/4" kort	inch	3/16, 7/32, 1/4, 9/32, 5/16, 11/32, 3/8, 7/16, 1/2	
Doppen 1/4" lang	inch	3/16, 7/32, 1/4, 9/32, 5/16, 11/32, 3/8, 7/16, 1/2	
Doppen 3/8" kort	inch	3/8, 7/16, 1/2, 9/16, 5/8, 11/16, 3/4	
Doppen 3/8" lang	inch	3/8, 7/16, 1/2, 9/16, 5/8, 11/16, 3/4	
Doppen 1/2" kort	inch	3/8, 7/16, 1/2, 9/16, 5/8, 11/16, 3/4, 13/16, 7/8, 15/16, 1, 11/8, 13/16, 1 1/4	
Afmetingen (l x b x h)	mm	568 x 374 x 32	
Prijs	€	225,00	

TENGOOLS



Set van 17 tangen. EVA-tray.

Order nr.	161720107		
Orig. nr.	TTEMB17		
Aantal stuks	17		
Zijkniptangen	mm	125 - 150	
Zijknip heavy duty tangen	mm	150 - 200 (15°)	
Kabelniptangen	mm	200	
Combinatietangen	mm	175 - 200	
Waterpomptangen	mm	175 - 200	
Ontmanteltangen	mm	175	
Bektangen	mm	150	
Circlips recht inwendig	mm	175	
Circlips gebogen inwendig	mm	175	
Circlips recht uitwendig	mm	175	
Circlips gebogen uitwendig	mm	175	
Afmetingen (l x b x h)	mm	568 x 374 x 32	
Prijs	€	263,00	

TENGOOLS

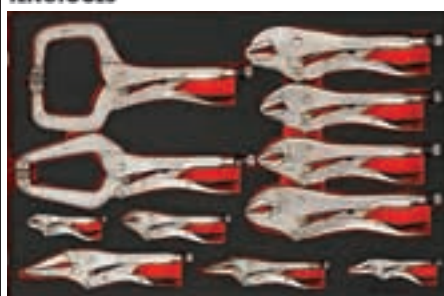

11-delige griptangenset gaande van 4" tot 12". EVA-tray.

Order nr.	161760103		
Orig. nr.	TTEVG11		
Aantal stuks	11		
Universele griptangen 401	mm	100 - 125 - 250 - 300	
Griptangen voor het lassen 406P	mm	280	
Universele griptangen 401F	mm	250 - 300	
Universele griptangen 404	mm	100 - 155 - 230	
Griptangen voor het lassen 409P	mm	300	
Afmetingen (l x b x h)	mm	568 x 374 x 32	
Prijs	€	179,00	



TENGOOLS



Tangenset 11dlg EVA-tray. Set bestaande uit Extra zware zijknijptang MB442-8T, Griptang 100mm- 401-4, 250mm - 401-10, met lang dun bekken 160mm - 404-6Combinatietang 175mm - MB452-7T, Lange recht bektang 200mm - MB461-8T, Circlipstang 170mm inwendig recht - MB470-7, gebogen - MB471-7, uitwendig recht - MB472-7, gebogen - MB473-7, Waterpompstang 250mm - MB481-10T.

Order nr.	178810107
Orig. nr.	TTEMB11
Afmetingen (l x b x h)	mm 570 x 375 x 32
Prijs	€ 167,00

TENGOOLS



122-delige schroevendraaier- en bitsset. EVA-tray.

Order nr.	186200101
Orig. nr.	TTEMD122N
Aantal stuks	122
Schroevendraaiers Plat	mm 2,5x75 - 3,5x75 - 3x100 - 4x100 - 5,5x75 - 5,5x150 - 6,5x38 (Stubby) - 6,5x100 - 6,5x150 - 8x150 - 10x200
Schroevendraaiers PH	mm 0x75 - 1x75 - 1x38 (Stubby) - 2x38 (Stubby) - 2x100 - 3x150 - 4x200
Bitsen Plat 25mm	mm 0,6x3,5 - 0,6x4,5 - 0,8x4 (2x) - 0,8x5,5 (2x) - 1,2x6,5 - 1,6x8
Bitsen Plat 50mm	mm 0,6x3,5 (3x) - 0,8x4 (3x) - 0,8x5,5 (3x) - 1,0x5,5 (3x) - 1,2x6,5 (3x)
Schroevendraaiers PZ	mm 0x75 - 1x100 - 1x38 (Stubby) - 2x38 (Stubby) - 2x100 - 2x150 - 3x150
Bitsen PH 25mm	1 - 2 - 3
Bitsen PZ 25mm	1 - 2 - 3
Bitsen TX 25mm	6 - 7 - 8 - 9 - 10 - 15 - 20 (3x) - 25 (3x) - 27 - 30 - 40
Bitsen TPX 25mm	10 - 15 - 20 (2x) - 25 (2x) - 27 - 30 - 40
Bitsen Hex 25mm	mm 2 - 3 - 4 - 5 - 6 - 8
Bitsen GR 25mm	2 (3x)
Bitsen PH 50mm	1 (3x) - 2 (6x) - 3 (3x)
Bitsen PZ 50mm	1 (2x) - 2 (2x) - 3
Bitsen 50mm TX	8 (3x) - 10 (6x) - 15 (3x) - 20 (6x) - 25 (6x) - 27 (3x) - 30 (3x)
Bitsen Hex 50mm	mm 4 (3x) - 5 (3x) - 6 (3x) - 8 (3x)
Afmetingen (l x b x h)	mm 570 x 375 x 75
Prijs	€ 179,00

TENGTOOLS



Set van 98 schroevendraaiers en bitsen. Geleverd in een tray met EVA schuim, geschikt voor Teng Tools koffers en gereedschapswagens.

Order nr.	186160107		
Orig. nr.	TTEMD98N		
Schroevendraaiers TX	8 - 9		
Schroevendraaiers TPX	TPX	10 - 15 - 20 - 25 - 30	
Schroevendraaiers met doorgaande schacht plat	mm	6,5x100 - 8x150 - 10x200	
Schroevendraaiers PH met doorgaande schacht	2x100 - 3x150		
Geïsoleerde schroevendraaiers Plat	mm	2,5x75 - 4x100 - 5,5x125	
Geïsoleerde schroevendraaiers PH	0x60 - 1x80 - 2x100		
Geïsoleerde schroevendraaiers PZ	2x100		
Bitsen lengte 25 mm, plat	mm	0,6x3,5 - 0,6x4,5 - 0,8x4,0 (x 2) - 0,8x5,5 - 1,0x5,5 (x 2) - 1,2x6,5 - 1,6x8,0	
Bitsen GR PH lengte 25 mm	PH	2 (x3)	
Bitsen lengte 25 mm voor int. hex gaten	mm	2 - 3 - 4 - 5 - 6 - 8	
Bitsen PH lengte 25 mm	PH	1 (x3) - 2 (x3) - 3 (x3)	
Bitsen PZ lengte 25 mm		3 (x3) - 2 (x3) - 3 (x4)	
Prijs	€	179,00	

TENGTOOLS



23-delige T-allenleutelset. EVA-tray.

Order nr.	166810101		
Orig. nr.	TTEX23		
Aantal stuks	23		
Sleutels TX	10 - 15 - 20 - 25 - 27 - 30 - 40		
Schroevendraaiers op dop	mm	5 - 5,5 - 6 - 7 - 8 - 10 - 11 - 12 - 13	
Sleutels Hex	mm	2,5 - 3 - 4 - 5 - 6 - 7 - 8	
Afmetingen (l x b x h)	mm	568 x 374 x 32	
Prijs	€	147,00	

TENGTOOLS



17-delige hex sleutel en inspectieset EVA-tray. Set bestaande uit Momentsleutel 1/2 200nM, TX sleutelset 8dlg 1477NX, Allensleutelset 9 dlg 1479MM, TX sleutelset 9dlg 1479TX, Allensleutel bolkop 7mm, Allensleutel 2.5 - 8mm, inspectieset 4dlg, Haak en pinnenset 4dlg

Order nr.	178860102		
Orig. nr.	TTEX17		
Aantal stuks	17		
Afmetingen (l x b x h)	mm	570 x 375 x 32	
Prijs	€	195,00	

TENGTOOLS



Basistoolset 12dlb EVA-tray. Bestaande uit Schroefleutel 150x250mm, metaal beugelzaag, breekmes, beitels 150 en 200mm, centerpunt 150x5mm, hamer 800gr, hamer met nylon en rubber kop, rolmeter 3m, 6 dlg doorslagset, Maatlat metaal 200mm.

Order nr.	178830105		
Orig. nr.	TTEPS12		
Afmetingen (l x b x h)	mm	570 x 375 x 32	
Prijs	€	155,00	

Gereedschap op muurrekken

TENGOOLS



Set van 6 dubbele flex-ringsleutels 12-kant. Gaande van 8 tot 19mm. Geleverd met een wandrek voor montage op een muur of wandpaneel.

Order nr.	128230109 ⓘ		
Orig. nr.	WRDFO6		
Kniesleutels	mm	8x9 - 10x11 - 12x13 - 14x15 - 16x17 - 18x19	
Prijs	€	82,90	

TENGOOLS



Set van 12 steekringsleutels gaande van 8 tot 19mm. De ringkant heeft een hellingshoek van 15°. Identieke maten aan beide kanten van de sleutel. Geleverd met een wandrek voor montage op een muur of wandpaneel.

Order nr.	128240108 ⓘ		
Orig. nr.	WRSP12		
Sleutels	mm	8 - 9 - 10 - 11 - 12 - 13 - 14 - 15 - 16 - 17 - 18 - 19	
Prijs	€	54,50	

TENGOOLS



Set van 5 handvijen L 250mm middelgrof. Bestaat uit 1 ronde, 1 halfronde, 1 vierkante, 1 driehoek en 1 platte handvijl. Geleverd met een wandrek voor montage op een muur of wandpaneel.

Order nr.	128660107 ⓘ		
Orig. nr.	WRFL05		
Prijs	€	49,90	

TENGOOLS



Set van 4 Mega Bite tangen bestaande uit 1 waterpomptang 250mm, 1 zijknijptang 150mm, 1 lange bektang 200mm en 1 combinatietang 175mm. Met kunstof zwart-rode handgrepen. Geleverd met een wandrek voor montage op een muur of wandpaneel.

Order nr.	128330107 ⓘ		
Orig. nr.	WRMB04		
Prijs	€	69,90	

TENGOOLS

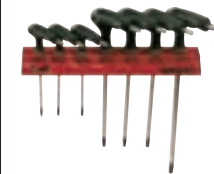

Set van 7 sleutels TX/TPX met T-hendel gaande van TX10 tot TX40. Met TPX aan de korte kant van de sleutel. Geleverd met een wandrek voor montage op een muur of wandpaneel.

Order nr.	128270105 ⓘ		
Orig. nr.	WRTX07		
Sleutels	TX-TPX	10 - 15 - 20 - 25 - 27 - 30 - 40	
Prijs	€	32,50	

TENGOOLS



Schroevendraaiers 1000V op muurrek.

Order nr.	174520106 ⓘ		
Orig. nr.	WRMDV05N		
Maat PH	0x75 - 1x75		
Maat PZ	1x75		
Schroevendraaiers Plat	mm	0,5x3,0x100 - 1,0x5,5x75	
Prijs	€	29,90	

TENGOOLS

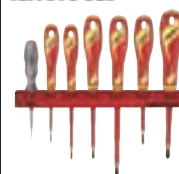

NEW

Schroevendraaiers 1000V op muurrek.

Order nr.	174520205 ⓘ		
Orig. nr.	WRMDV07N		
Schroevendraaiers Plat	mm	0,4x2,5x75mm, 0,5x3,0x100mm, 0,8x4,0x100mm, 1,0x5,5x125mm	
Schroevendraaiers PH	mm	PH1x80mm, PH2x100mm	
Voltage tester	100V-250V		
Prijs	€	32,90	

- Alle Teng Tools doppen en accessoires zijn individueel gemerkt en vervaardigd uit hoogwaardig chroom vanadium staal, in overeenstemming met de meest recente DIN en ISO standards.
- Alle Teng Tools doppen zijn voorzien van het "hip grip" systeem om de kracht op de kant en niet op de hoek te oefenen. Dit voorkomt dat de bouten beschadigd worden, en maakt het gebruik op eerder beschadigde bouten mogelijk.
- Veiligheidsvergrendeling in $\frac{3}{4}$ " doppen, om te voorkomen dat de doppen van het verlengstuk loskomen.
- Elke dop en accessoire wordt op een PP kaart geleverd, inclusief voor $\frac{1}{4}$ ", $\frac{3}{8}$ " en $\frac{1}{2}$ " een speciale clip voor gebruik op de Teng Tools aluminium rails. Daarmee kan de gebruiker zijn eigen rails volgens zijn specifieke eisen samenstellen.



Doppen en Accessoires

Doppen en accessoires

Het assortiment omvat ¼" tot 1" doppen, 6- en 12-kant, metrisch en AF evenals TX-E. Een brede selectie van dopbitsen voor HEX, TX en TPX wordt verder aangevuld door een reeks adapters voor gebruik met het uitgebreide aanbod aan bitsen in het hoofdstuk schroevendraaiers van deze catalogus.



Ratels

TENGOOLS



Set van 3 Teng ratels 72-tands van 1/4", 3/8" en 1/2". TC-tray.

Order nr.	128210101		
Orig. nr.	TT7203		
Aantal stuks	3		
Ratels	inch	1/4 - 3/8 - 1/2	
Afmetingen (l x b x h)	mm	265 x 142 x 50	
Prijs	€	89,50	

TENGOOLS



Mini bitsratel 1/4" L.90mm met aan de andere sleutelzijde een 8mm ringopname. Chroom-vanadium. Verchroomde uitvoering.

Order nr.	118340108		
Orig. nr.	1400B		
Lengte	mm	90	
Prijs	€	22,50	

TENGOOLS



Ratel 1/4" handpalm-model. Met links-rechtsomkeerknop in het handvat. Ideaal voor gebruik in nauwe plaatsjes.

Order nr.	132090101		
Orig. nr.	1400M		
Aansluiting	inch	1/4	
Aantal tanden	45		
Lengte	mm	76	
Prijs	€	20,50	

TENGOOLS



Universele Teng ratel model FRP met 45-tands aandrijfmechanisme. Gepatenteerde (24583ROC) vezelversterkte uitvoering. Zeer licht eigengewicht maar sterk. Links-rechtsinstelling dmv een hendel. Snel-ontkoppelknop (push-through) vergemakkelijkt het loslaten van de dop.

Order nr.	74290107	74290206	74290305
Orig. nr.	1400FRP	3800FRP	1200FRP
Aansluiting	inch	1/4	3/8
Aantal tanden	45		
Lengte	mm	150	200
Prijs	€	26,50	33,50

TENGOOLS



Universele ratel met 60-tands aandrijfmechanisme. Chroom-vanadium. Verchroomde uitvoering. Rubber bekleed handvat. Links-rechtsinstelling dmv een hendel. Snel-ontkoppelknop (push-through) vergemakkelijkt het loslaten van de dop.

Order nr.	160700100	160700209	160700308
Orig. nr.	1400-60T	3800-60T	1200-60T
Aansluiting	inch	1/4	3/8
Aantal tanden	60		
Lengte	mm	150	200
Prijs	€	37,00	42,50

TENGOOLS



NEW

Universele Teng ratel met 72-tands aandrijfmechanisme. Chroom-vanadium. Matverchroomde uitvoering. Twee-componenten kunststof handvat. Links-rechtsinstelling dmv een draaiknop. Snel-ontkoppelknop (push-through) vergemakkelijkt het loslaten van de dop.

Order nr.	186140109	186140208	186140307
Orig. nr.	1400-72N	3800-72N	1200-72N
Aansluiting	inch	1/4	3/8
Aantal tanden	72		
Lengte	mm	150	203
Prijs	€	40,50	45,50

TENGOOLS



NEW

72 tanden flexibele ratel. Increment van slechts 5 graden. 3/8" met snelle ontkoppeling en omkering systeem. 1/4" met omkering systeem. Satijn afwerking. Twee componenten handvat.

Order nr.	186900106	186900205
Orig. nr.	1400-72SN	3800-72SN
Aansluiting	inch	1/4
Aantal tanden	72	
Lengte	mm	150
Prijs	€	40,00

TENGOOLS



Ratel 1/2" met 45-tands aandrijfmechanisme. Extra lange uitvoering L.432mm. Chroom-Vanadium. Matverchroomde uitvoering. Twee-componenten kunststof handvat. Links-rechtsinstelling dmv draaiknop in de kop. Snel-ontkoppelknop (push-through) vergemakkelijkt het loslaten van de dop.

Order nr.	143830107		
Orig. nr.	1200L		
Aansluiting	inch	1/2	
Aantal tanden	45		
Lengte	mm	432	
Prijs	€	41,50	

TENGOOLS



Ratel 1/2" met 60-tands aandrijfmechanisme. Met onder de hoek verstelbare kop. Extra lange uitvoering L.432mm. Chroom-vanadium. Matverchromde uitvoering. Twee-componenten kunststof handvat. Links-rechtsinstelling dmv draaiknop in de kop. Snel-ontkoppelknop.

Order nr.	118060102	T
Orig. nr.	1200F	
Aansluiting	inch	1/2
Aantal tanden		60
Lengte	mm	432
Prijs	€	65,50

TENGOOLS



Ratel 3/4". Industriële uitvoering. Met 72-tands aandrijfmechanisme. Chroom-Vanadium. Matverchromde uitvoering. Links-rechtsinstelling dmv draaiknop gemonteerd bovenop de ratelkop. Snel-ontkoppelknop (push-through) vergemakelijkt het loslaten van de dop.

Order nr.	143820108	T
Orig. nr.	M3400-72	
Aansluiting	inch	3/4
Aantal tanden		72
Lengte	mm	505
Prijs	€	139,00

TENGOOLS



Universele Teng ratel. Model DIN 3122D met 24-tands (1") aandrijfmechanisme. Chroom-vanadium. Verchromde uitvoering. Links-rechtsinstelling dmv een hendel. Snel-ontkoppelknop (push-through) vergemakelijkt het loslaten van de dop.

Order nr.	73720500	T
Orig. nr.	M1100	
Aansluiting	inch	1
Aantal tanden		24
Lengte	mm	660
Prijs	€	119,00

TENGOOLS



Ratel 1" met 72-tands aandrijf mechanisme. Industriële uitvoering. Chroom-Vanadium. Matverchromde uitvoering. Links-rechtsinstelling dmv draaiknop gemonteerd bovenop de ratelkop. Snel-ontkoppelknop (push-through) vergemakelijkt het loslaten van de dop.

Order nr.	143810109	T
Orig. nr.	M1100-72	
Aansluiting	inch	1
Aantal tanden		72
Lengte	mm	800
Prijs	€	184,00

TENGOOLS



Herstelsets voor ratels.

Order nr.	Orig. nr.	Voor type ratel	Prijs €
117391409	3800-72RK	3800-72	21,50
74291006	1400FRPK	1400FRP	14,50
74291105	3800FRPK	3800FRP	19,90
74291204	1200FRPK	1200FRP	19,50
73722050	1400NRK	1400 + PT1400 (generation 2)	11,50
73722159	3800NRK	3800 + PT3800 (generation 2)	12,50
73722209	1200NRK	1200 + PT1200 (generation 2)	15,50
73721003	1400RK-1	1400 (generation 1)	16,50
73721102	3800RK-1	3800 (generation 1)	19,90
73721201	1200RK-1	1200 (generation 1)	23,50
801200341	TT1400STRK	1400ST	13,50
801200344	TT3800STRK	3800ST	17,00
801200336	TT1200STRK	1200ST	13,50
73721300	3400-3RK	3400-3	45,50
73721409	1100RK	1100	51,50
73722308	M3400-3RK	M3400-3	50,50
73722407	M1100RK	M1100	55,50
143811008	M1100-72RK	M1100-72	62,50
143821007	M3400-72RK	M3400-72	53,50
118060201	1200FRK	1200F	14,00
128201001	1400-72STRK	1400-72ST	17,50
160701207	1200-60TRK	1200-60T	25,50
160701009	1400-60TRK	1400-60T	17,50
160701108	3800-60TRK	3800-60T	20,50
117391151	3800-72RK-1	3800-72	22,50
117391250	1200-72RK-1	1200-72	27,90

T-hendels

TENGOOLS



T-baar. DIN3122A. chroom vanadium. Matverchromde uitvoering. Type S is met safety lock. M110030 met opening voor T-baar.

Order nr.	Orig. nr.	Lengte mm	Aansluiting inch	Prijs €
35870104	M140050	105	1/4	6,20
35870153	M380050	170	3/8	13,50
35870179	M120050	243	1/2	16,90
35870203	M340050	450	3/4	25,90
35870302	M340050S-C	450	3/4	31,50
35650407	M110030		1 (adaptor)	28,50
116840208	M110020	550	1 (baar)	42,50

Wielsleutels

TENGOOLS



Wielsleutel geleverd met slagdrop met dubbele maatvoering. Uitschuifbaar voor een betere krachtgeving bij het lossen van wioldoppen. Chroom vanadium staal. Onmisbaar in elke wagen. Je mist deze sleutel wanneer het te laat is...

Order nr.	73170102	186810107
Orig. nr.	1202	1202A
Maten	mm 17, 19	21, 22
Aansluiting	inch 1/2	1/2
Lengte ingetrokken/verlengd	mm 350/550	350/550
Prijs	€ 22,50	22,50

TENGOOLS



U-wielsleutel. chroom vanadium. Matverchromde uitvoering.

Order nr.	112040100	112040209
Orig. nr.	M380011-C	M120011-C
Aansluiting	inch 3/8	1/2
Lengte	mm 380	420
Prijs	€ 17,50	19,50

Flexhendels

TENGOOLS



11-delige set met 10 lange doppen 1/2" 12-kant en 1 handvat 1/2" met flexibele aansluiting 250mm. TC-tray.

Order nr.	122090103
Orig. nr.	TT1211
Doppen 1/2" lang	mm 10 - 11 - 12 - 13 - 14 - 15 - 16 - 17 - 18 - 19
Afmetingen (l x b x h)	mm 265 x 142 x 50
Prijs	€ 56,50

TENGOOLS



M120010



1201



340070S-CM

Flex-hendel. chroom vanadium. Matverchromde uitvoering. Twee-componenten kunststof handvat (niet 3/4"). Type S is met safety lock.

Order nr.	Orig. nr.	Lengte mm	Aansluiting inch	Prijs €
73980104	M120010	250	1/2	24,50
73980203	1201	425	1/2	30,00
73980252	1201A	600	1/2	48,90
73980302	M340070	475	3/4	52,90
73980401	M340070S-C	475	3/4	43,50

TENGOOLS



Repairkits voor flexhendels.

Order nr.	73981003	73982001	73981052
Orig. nr.	1201RK	FHP3402	1201ARK
Voor flex hendel	1201	M340070S	1201A
Prijs	€ 16,00	11,50	15,90

TENGOOLS



Chroom vanadium. Gesatineerd. Twee-componenten handvat.

Order nr.	152800108
Orig. nr.	M380010A-C
Lengte	mm 250
Aansluiting	inch 3/8
Prijs	€ 21,10

Verlengstukken

TENGOOLS

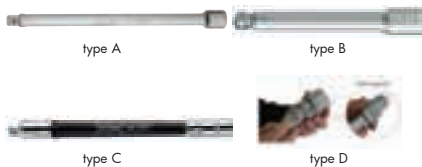

Verlengstukken. DIN3123B. chroom vanadium. Matverchroomde uitvoering. Type A: klassiek verlengstuk. Type B: type met bolkop (wobble) aan de dop-kant. Type C: flexibel verlengstuk in kunststof. Type D: met safety lock. Type E: Roestvrijstaal.

Order nr.	Orig. nr.	Type	Lengte mm	Aansluiting inch	Prijs €
29960101	M140038-C	C	150	1/4	9,60
06790109	M140020	A	50	1/4	3,10
06790158	M140023	A	75	1/4	3,40
06790208	M140021	A	100	1/4	3,90
06790307	M140022	A	150	1/4	4,30
06790356	M140024	A	300	1/4	10,50
06790406	M380020	A	75	3/8	4,00
162610109	MS380020-C	E	75	3/8	27,50
01101708	M380020W-C	B	75	3/8	9,00
06790455	M380023	A	125	3/8	5,70
162610208	MS380023-C	E	125	3/8	41,00
06790505	M380021	A	150	3/8	6,40
01101807	M380021W	B	150	3/8	10,90
06790604	M380022	A	250	3/8	9,50
01101906	M380022W	B	250	3/8	13,50
06790703	M380024	A	500	3/8	33,90
73860108	M120020	A	60	1/2	5,70
01102003	M120020W	B	75	1/2	12,50
73860207	M120021	A	125	1/2	7,90
73860256	M120023	A	150	1/2	9,00
162590103	MS120021-C	E	125	1/2	55,50
01102102	M120021W	B	150	1/2	16,50
73860306	M120022	A	250	1/2	13,90
01102201	M120022W	B	250	1/2	20,50
73860355	M120024	A	500	1/2	35,50
73860405	M340020	A	100	3/4	15,90
73860454	M340020S-C	D	100	3/4	23,50
73860504	M340021	A	200	3/4	19,50
73860553	M340021S-C	D	200	3/4	26,90
73860603	M340022	A	400	3/4	28,50
73860652	M340022S-C	D	400	3/4	37,90
73860702	M110040	A	200	1	44,50
73860801	M110050	A	400	1	73,50

Adaptors

TENGOOLS



Elleboogstuk. DIN3123C. chroom vanadium. Matverchroomde uitvoering.

Order nr.	Orig. nr.	Aansluiting inch	Prijs €
74110057	M140030	1/4	10,50
74110073	M380030	3/8	11,90
74110107	M120030	1/2	18,50
74110206	M340030	3/4	34,50

TENGOOLS



Adaptor. M380036-C en M110030-C : met een opening voor aanschroeven met een staaf. chroom vanadium. Matverchroomde uitvoering.

Order nr.	Orig. nr.	Aansluiting inch	Prijs €
35650050	M140036	1/4F x 3/8M	2,80
35640101	M380035	3/8F x 1/4M	4,90
35650100	M380036	3/8F x 1/2M	6,60
35640200	M120036	1/2F x 3/8M	5,80
35650209	M120037	1/2F x 3/4M	7,60
35650407	M110030	1 (adaptor)	28,50
35650308	M340085	3/4F x 1M	19,50
35640309	M340086-C	3/4F x 1/2M	10,00

TENGOOLS



Dopbitshouder. DIN3126. chroom vanadium. Matverchroomde uitvoering.

Order nr.	Orig. nr.	Aansluiting inch	Voor bitzen	Prijs €
35630102	M140060	1/4	1/4" hex	3,30
35810100	M380060	3/8	1/4" hex	3,90
101670057	M380061	3/8	10mm hex	6,60
35810209	M120060	1/2	5/16" hex	7,70
101670107	M120061	1/2	10mm hex	10,90
101670206	M120062	1/2	12mm hex	12,50

TENGOOLS



Adaptor. Met zeskant aansluiting. Voor montage op boorkop en uitwendige SQUARE-aansluiting voor doppen aan het andere einde.

Order nr.	117110106	117110205
Orig. nr.	M140037	M380037
Hexagonale aansluiting	1/4	1/4
Vierkante aansluiting	1/4	3/8
Prijs	€ 1,70	4,90

TENGOOLS



Adaptor met een opening voor aanschroeven met een staaf. RVS.

Order nr.	167600105	167600204
Orig. nr.	MS380036-C	MS120036-C
Aansluiting	inch 3/8	1/2
Type	3/8F x 1/2M	1/2F x 3/8M
Opening	✓	✓
Prijs	€ 23,00	23,00

Koppelvermeeders

TENGOOLS



Set. Bestaande uit 1 momentsleutel 1/2" 40-200Nm en 1 krachtvermeederaar 1/2"-3/4" 1400Nm. TTX-tray.

Order nr.	128220100		
Orig. nr.	TTXMP12		
Inkomende aansluiting	inch	1/2	
Krachtvermeederaar	Nm	1400	
Momentsleutel 1/2"	Nm	40-200 (max. 200x3 met momentsleutel in deze set)	
Uitgaande aansluiting	inch	3/4	
Prijs	€	329,00	

TENGOOLS



Krachtvermeederaar. Met ratio 1:3. Precisie-instrument voor het losmaken en vastzetten van bouten en moeren. Te gebruiken met momentsleutel en slagdoppen.

Order nr.	122070105	122070204	174650101
Orig. nr.	MP1400	MP2700	MP91500
Inkomende aansluiting	inch 1/2	3/4	1/2
Uitgaande aansluiting	inch 3/4	1	3/4
Versterking	1:3	1:3	1:10
Maximum bereik	lbs.ft 1000	2000	1100
Maximum bereik	Nm 1400	2700	1500
Prijs	€ 307,00	365,00	319,00

TENGOOLS



Steen voor krachtvermeederaar.

Order nr.	122070303	122070402
Orig. nr.	MPSL01	MPSL02
Omschrijving	voor MP1400	voor MP2700
Prijs	€ 37,00	39,50

TENGOOLS



Herstelkit voor krachtvermeeders.

Order nr.	Orig. nr.	Prijs €
122070808	MP1400RK	147,00
122070907	MP1400RK-1	147,00
122070956	MP2700RK-1	159,00
122070857	MP2700RK	159,00
174651000	MP91500RK	127,00

Dop -en dopbits schroevendraaiers

TENGOOLS



Dop en dopbits schroevendraaier met vierkant-aandrijving 1/4" of 3/8". chroom vanadium. Matverchroomde uitvoering. Met hard kunststof handvat. Handvat met interne aansluiting voor gebruik met een T-hendel.

Order nr.	34860106	34860205
Orig. nr.	M140015	M380015
Lengte	mm 150	255
Aansluiting	inch 1/4	3/8
Prijs	€ 10,90	18,50

TENGOOLS



Dop en dopbits schroevendraaier met vierkant-aandrijving 3/8". chroom vanadium. Matverchroomde uitvoering. Met 3/8"-F aandrijving in de top van de hendel.

Order nr.	03050101
Orig. nr.	PT3810R
Lengte	mm 250
Aansluiting	inch 3/8
Prijs	€ 23,50

Bougiedoppen

TENGOOLS



5-delige set van flex-bougiedoppen 3/8". Met opening voor T-hendel. Met T-baar. TTX-tray.

Order nr.	178801007
Orig. nr.	TTXTB05
Doppen 3/8"	mm 14 - 16 - 21
Handvat lengte	mm 520
Afmetingen (l x b x h)	mm 560 x 110 x 40
Prijs	€ 63,50

TENGOOLS



Bougiedoppen 3/8" en 1/2" 6-kant. Met rubber-inzet. Met uitwendige 24mm zeskant-aansluiting op het uiteinde van de dop voor aanspannen met een sleutel. chroom vanadium. Matverchroomde uitvoering.

Order nr.	Orig. nr.	Maat mm	Lengte mm	Aansluiting inch	Type	Prijs €
39820055	M380039-C	14	64	3/8	standaard	5,10
39820105	M380040	16	64	3/8	standaard	4,90
39820121	M380041	16	85	3/8	flexibel	14,50
39820154	M380042	18	70	3/8	standaard	6,70
39820204	M380046	21	70	3/8	standaard	6,90
39820303	M380047	21	91	3/8	flexibel	15,50
69790103	M120040	16	70	1/2	standaard	7,20
69790202	M120042	18	70	1/2	standaard	9,00
69790301	M120046	21	70	1/2	standaard	10,00

Doppen 1/4"

TENGOOLS



Dop 1/4" 6-kant. Korte uitvoering 25mm. DIN 3124-ISO 2725. chroom vanadium. Matverchroomde uitvoering.

Order nr.	Orig. nr.	Maat mm	Maat inch	Prijs €
25670100	M140504	4		2,40
25670159	M1405045	4,5		2,40
25670209	M140505	5		2,40
25670258	M1405055	5,5		2,40
25670308	M140506	6		2,40
25670407	M140507	7		2,40
25670506	M140508	8		2,40
25670605	M140509	9		2,40
25670704	M140510	10		2,60
25670803	M140511	11		2,70
25670902	M140512	12		2,95
25671009	M140513	13		2,95
69800100	M140106		3/16	1,91
69800209	M140107		7/32	1,91
69800308	M140108		1/4	1,91
69800407	M140109		9/32	1,91
69800506	M140110		5/16	1,91
69800605	M140111		11/32	1,91
69800704	M140112		3/8	2,22
69800803	M140114		7/16	2,22
69800902	M140116		1/2	2,78

TENGOOLS



Dop 1/4" 6-kant. Lange uitvoering. L. 49,5mm. DIN 3124-ISO 2725. chroom vanadium. Matverchroomde uitvoering.

Order nr.	Orig. nr.	Maat mm	Maat inch	Prijs €
35620038	M140604	4		5,50
35620061	M140605	5		5,50
35620095	M1406055	5,5		5,50
35620103	M140606	6		5,80
35620202	M140607	7		5,80
35620301	M140608	8		5,80
35620350	M140609	9		5,80
35620400	M140610	10		5,80
35620459	M140611	11		5,80
35620509	M140612	12		6,10
35620608	M140613	13		6,10
69890101	M140206		3/16	4,90
69890150	M140207		7/32	4,90
69890200	M140208		1/4	4,90
69890259	M140209		9/32	4,90
69890309	M140210		5/16	4,90
69890358	M140211		11/32	4,57
69890408	M140212		3/8	4,57
69890507	M140214		7/16	4,57
69890606	M140216		1/2	5,10

TENGOOLS



Afzonderlijke carterplug-doppen met verschillende typen en maten geschikt voor carterpluggen in de motor en versnellingsbak.

Order nr.	Orig. nr.	Maat	Prijs €
62571005	DP0810	hex 8mm x 10mm hex	9,90
62571104	DP0812	vierkant 8mm x 3/8" vierkant	9,90
62571203	DP1012	hex 5/16" x 3/8" hex	9,90
62571302	DP1112	vierkant 11mm x 12mm hex	9,90
62571401	DP1314	vierkant 13mm x 14mm hex	9,90
62571500	DP1716	hex 17mm x 1/2" hex	9,90

TENGOOLS



Dop 1/4" TX-E. Korte uitvoering. Chroom Vanadium. Matverchroomde uitvoering.

Order nr.	Orig. nr.	Maat TX-E	Lengte mm	Prijs €
101850105	M140704	E4	23,1	3,10
101850204	M140705	E5	24,8	3,10
101850303	M140706	E6	24,8	3,10
101850402	M140707	E7	24,8	3,10
101850501	M140708	E8	24,8	3,10

TENGOOLS



Dopbits 1/4" met Plat-bits. chroom vanadium. Matverchroomde uitvoering.

Order nr.	Orig. nr.	Lengte mm	Maat plat	Prijs €
68280205	M1414055	32	1,2x5,5	4,13
68280304	M141407	32	1,4x7	4,13
68280106	M141404	32	0,76x4	4,13

TENGOOLS



Dopbits 1/4" met Philips-bits. chroom vanadium. Matverchroomde uitvoering.

Order nr.	Orig. nr.	Lengte mm	Maat PH	Prijs €
68260058	M141300	32	0	3,68
68260108	M141301	32	1	3,68
68260207	M141302	32	2	3,68
68260306	M141303	32	3	4,13



TENGTOLS



Dopbits 1/4" met Pozidriv-bits. chroom vanadium. Matverchroomde uitvoering.

Order nr.	Orig. nr.	Lengte mm	Maat PZ	Prijs €
68350107	M141601	32	1	4,13
68350206	M141602	32	2	4,13
68350305	M141603	32	3	3,89

TENGTOLS



Dopbits 1/4" met TX-bits. chroom vanadium. Matverchroomde uitvoering.

Order nr.	Orig. nr.	Lengte mm	Maat TX	Prijs €
112060108	M141210FC	32	10	3,70
112060207	M141215FC	32	15	3,70
112060306	M141220FC	32	20	3,70
112060405	M141225FC	32	25	3,70
112060504	M141227FC	32	27	3,70
112060603	M141230FC	32	30	3,70
112060702	M141240FC	32	40	4,10

TENGTOLS



Tapdop 1/4" om draad te snijden. Te gebruiken met een mini palm ratel.

Order nr.	167490200		167490309	
Orig. nr.	M140071	M140072		
Voor tappen	M	3-8	5-12	
Diameter koppel	mm	20	25	
Prijs	€	11,50	13,50	

Doppen 3/8"

TENGTOLS



Dop 3/8" 6-kant. Korte uitvoering. DIN 3124-ISO 2725. chroom vanadium. Matverchroomde uitvoering.

Order nr.	Orig. nr.	Maat mm	Lengte mm	Maat inch	Prijs €
26210054	M380507	7	25,7		3,10
26210104	M380508	8	25,7		3,10
26210203	M380509	9	25,7		4,45
26210302	M380510	10	25,7		4,50
26210401	M380511	11	25,7		4,50
26210500	M380512	12	25,7		4,50
26210609	M380513	13	25,7		4,50
26210708	M380514	14	25,7		4,10
26210807	M380515	15	25,7		4,60
26210906	M380516	16	29		4,60
26211003	M380517	17	29		4,60
26211102	M380518	18	29		5,10
26211201	M380519	19	29		5,40
26211300	M380520	20	29		5,30
26211409	M380521	21	29		5,80
26211508	M380522	22	29		6,10
69950103	M380110		25,7	5/16	3,68
69950202	M380112		25,7	3/8	3,68
69950301	M380114		25,7	7/16	3,68
69950400	M380116		25,7	1/2	3,68
69950509	M380118		25,7	9/16	3,68
69950608	M380120		29	5/8	3,68
69950707	M380122		29	1 1/16	4,57
69950806	M380124		29	3/4	5,10
69950905	M380126		29	13/16	5,60
69951002	M380128		29	7/8	5,90

TENGOOLS



Dop 3/8" 6-kant. Lange uitvoering. DIN 3124-ISO 2725. chroom vanadium. Matverchromde uitvoering.

Order nr.	Orig. nr.	Maat mm	Lengte mm	Maat inch	Prijs €
35860055	M380607	7	45,5		5,90
35860105	M380608	8	45,5		5,60
35860154	M380609	9	45,5		5,90
35860204	M380610	10	45,5		6,40
35860253	M380611	11	45,5		6,40
35860303	M380612	12	45,5		6,60
35860402	M380613	13	45,5		6,40
35860451	M380614	14	50		6,80
35860477	M380615	15	53		6,80
35860493	M380616	16	53		8,10
35860501	M380617	17	56		8,40
35860550	M380618	18	56		8,40
35860600	M380619	19	56		9,40
35860709	M380620	20	63,5		8,30
35860808	M380621	21	63,5		8,40
35860907	M380622	22	63,5		8,60
69970101	M380212		45,5	3/8	5,20
69970200	M380214		45,5	7/16	5,30
69970309	M380216		45,5	1/2	5,30
69970408	M380218		50	9/16	5,60
69970507	M380220		53	5/8	5,80
69970606	M380222		56	1 1/16	8,00
69970705	M380224		56	3/4	8,80
69970804	M380226		63,5	13/16	8,60
69970903	M380228		63,5	7/8	9,40

TENGOOLS



Dop 3/8" TX-E. Korte uitvoering. chroom vanadium. Matverchromde uitvoering.

Order nr.	Orig. nr.	Lengte mm	Maat TX-E	Prijs €
101690105	M380710	28	E 10	5,30
101690204	M380712	28	E 12	5,30
101690303	M380714	28	E 14	5,30
101690402	M380716	28	E 16	5,30
101690501	M380718	28	E 18	5,30

TENGOOLS



Dopbits 3/8" met Hex-bits. Korte uitvoering. Chroom vanadium. Matverchromde uitvoering. L. 49,5mm.

Order nr.	Orig. nr.	Maat mm	Maat inch	Prijs €
102070109	M381503	3		5,00
102070208	M381504	4		5,00
102070307	M381505	5		5,00
102070406	M3815055	5,5		5,00
102070505	M381506	6		5,00
102070604	M381507	7		5,00
102070703	M381508	8		5,00
102070802	M381510	10		5,60
102070901	M381512	12		6,60
114820103	M381103		3/32	5,30
114820202	M381104		1/8	5,30
114820301	M381105		5/32	5,30
114820400	M381106		3/16	5,30
114820509	M381107		7/32	5,20
114820608	M381108		1/4	5,30
114820707	M381110		5/16	5,20
114820806	M381112		3/8	5,30

TENGOOLS



Dopbits 3/8" met TX-bits. Korte uitvoering. chroom vanadium. Matverchromde uitvoering. L. 49,5mm.

Order nr.	Orig. nr.	Maat TX	Prijs €
102080108	M381210T	10	5,00
102080207	M381215T	15	5,00
102080306	M381220T	20	5,00
102080405	M381225T	25	5,00
102080504	M381227T	27	5,00
102080603	M381230T	30	5,00
102080702	M381240T	40	5,00
102080801	M381245T	45	5,00
102080900	M381250T	50	5,00

TENGTOLS



Dopbits 3/8" met TPX-bits. Korte uitvoering. chroom vanadium. Matverchromde uitvoering. L. 49,5mm.

Order nr.	Orig. nr.	Maat TPX	Prijs €
102090107	M381210	10	5,00
102090206	M381215	15	5,00
102090305	M381220	20	5,00
102090404	M381225	25	5,00
102090503	M381227	27	5,00
102090602	M381230	30	5,00
102090701	M381240	40	5,00
102090800	M381245	45	5,00
102090909	M381250	50	5,00

Doppen 1/2"

TENGTOLS



Dop 1/2" 12-kant. Korte uitvoering. DIN 31 24-ISO 2725. chroom vanadium. Matverchromde uitvoering.

Order nr.	Orig. nr.	Maat mm	Lengte mm	Maat inch	Prijs €
74310038	M120508	8	38		4,10
74310061	M120509	9	38		4,10
74310103	M120510	10	38		4,10
74310202	M120511	11	38		4,05
74310301	M120512	12	38		4,10
74310400	M120513	13	38		4,10
74310509	M120514	14	38		4,10
74310608	M120515	15	38		4,10
74310707	M120516	16	38		4,20
74310806	M120517	17	38		5,30
74310905	M120518	18	38		5,40
74311002	M120519	19	38		6,10
74311101	M120520	20	38		6,40
74311200	M120521	21	38		6,40
74311309	M120522	22	40		6,70
74311408	M120523	23	40		6,90
74311507	M120524	24	40		7,20
74311556	M120525	25	40		8,70
74311655	M120526	26	40		8,70
74311804	M120527	27	43		8,80
74311754	M120528	28	43		8,90
74311853	M120529	29	43		9,50
74312109	M120530	30	43		9,70
74312208	M120532	32	43		10,50
74312257	M120534	34	45,5		11,00
74315508	M120112	38		3/8	4,10
74315607	M120114	38		7/16	4,10
74315706	M120116	38		1/2	4,10
74315805	M120118	38		9/16	4,10
74316001	M120120	38		5/8	4,10
74316100	M120122	38		11/16	4,10
74316209	M120124	38		3/4	5,60
74316407	M120126	38		13/16	6,10
74316506	M120128	40		7/8	6,90
74316605	M120130	40		15/16	7,40
74316704	M120132	43		1	8,20
74316803	M120134	43		1 1/16	8,80
74316902	M120136	43		1 1/8	8,90
74317009	M120138	43		1 3/16	9,70
74317108	M120140	43		1 1/4	10,50

TENGTOLS



10-delige extra lange doppen set 3/8" met T-schacht en kunststof hendel. Geleverd in een handige rollas.

Order nr.	Orig. nr.	Maat mm	Lengte mm	Prijs €
	178791000			
Orig. nr.	TBW10			
Doppen 3/8"	mm	7 · 8 · 10 · 12 · 13 · 14 · 17 · 19		
Lengte 2-delige T-hendel	mm	300		
Prijs	€	93,00		

TENGTOLS



T-bar met lange dop. Aansluiting 3/8".

Order nr.	Orig. nr.	Maat mm	L mm	B mm	D mm	Prijs €
178790051	TBSKT07	7	300	19	10,8	14,00
178790101	TBSKT08	8	300	19	12	14,00
178790309	TBSKT10	10	300	19	14,7	14,00
178790507	TBSKT12	12	300	19	17,1	15,00
178790606	TBSKT13	13	300	19	18,5	15,00
178790705	TBSKT14	14	300	19	19,5	15,00
178790804	TBSKT17	17	300	19	23,3	17,00
178790903	TBSKT19	19	300	19	25,7	17,00

TENGOOLS



Dop 1/2" 6-kant. Korte uitvoering. mm-uitvoering. DIN 3124-ISO 2725. chroom vanadium. Matverchromde uitvoering.

Order nr.	Orig. nr.	Maat mm	Lengte mm	Prijs €
74313008	M1205106	10	38	3,90
74313107	M1205116	11	38	4,10
74313206	M1205126	12	38	4,10
74313305	M1205136	13	38	4,10
74313404	M1205146	14	38	4,10
74313503	M1205156	15	38	4,10
74313602	M1205166	16	38	4,10
74313701	M1205176	17	38	4,50
74313800	M1205186	18	38	5,30
74313909	M1205196	19	38	5,70
74314006	M1205206	20	38	6,40
74314105	M1205216	21	38	6,40
74314204	M1205226	22	40	6,60
74314303	M1205236	23	40	6,90
74314402	M1205246	24	40	7,30
74314501	M1205256	25	40	7,70
74314600	M1205266	26	40	8,20
74314709	M1205276	27	43	8,80
74314808	M1205286	28	43	8,80
74314907	M1205296	29	43	9,50
74315003	M1205306	30	43	9,50
74315102	M1205326	32	43	9,90
74312307	M1205336	33	45,5	11,90
74315201	M1205346	34	45,5	14,50

TENGOOLS



Dop 1/2" 12-kant. Lange uitvoering. 79 mm-uitvoering. DIN 3124-ISO 2725. chroom vanadium. Matverchromde uitvoering.

Order nr.	Orig. nr.	Maat mm	Prijs €
25730102	M120610	10	9,40
25730201	M120611	11	9,40
25730300	M120612	12	9,50
25730409	M120613	13	9,50
25730508	M120614	14	9,80
25730607	M120615	15	9,80
25730706	M120616	16	9,80
25730805	M120617	17	9,80
25730904	M120618	18	9,90
25731001	M120619	19	9,90
25731100	M120620	20	10,50
25731209	M120621	21	10,50
25731308	M120622	22	10,50
25731407	M120624	24	10,90
25731506	M120627	27	16,50
25731605	M120630	30	18,90
25731704	M120632	32	20,50
25731803	M120636	36	22,50

TENGOOLS



Dop 1/2" 6-kant. Lange uitvoering. 79mm-uitvoering. DIN 3124-ISO 2725. chroom vanadium. Matverchromde uitvoering.

Order nr.	Orig. nr.	Maat mm	Prijs €
25732009	M1206136	13	9,70
25732108	M1206146	14	9,70
25732207	M1206156	15	9,70
25732306	M1206166	16	9,70
25732405	M1206176	17	9,80
25732504	M1206186	18	9,80
25732603	M1206196	19	9,80
25732702	M1206246	24	10,90

TENGOOLS



Dopbits 1/2" met Hex-bits. Korte uitvoering. mm-uitvoering. chroom vanadium. Matverchromde uitvoering. L. 55mm.

Order nr.	Orig. nr.	Maat mm	Prijs €
68200104	M121505	5	5,90
68200203	M121506	6	5,90
68200302	M121507	7	5,90
68200401	M121508	8	5,90
68200500	M121509	9	5,90
68200609	M121510	10	6,60
68200708	M121512	12	7,70
68200807	M121514	14	8,80
68200906	M121517	17	11,50

TENGOOLS



Dopbits 1/2" met Hex-bits. Lange uitvoering. mm-uitvoering. chroom vanadium. Matverchromde uitvoering.

Order nr.	Orig. nr.	Maat mm	Prijs €
117450106	M122505	5	7,70
117450205	M122506	6	7,70
117450304	M122507	7	7,70
117450403	M122508	8	7,70
117450502	M122510	10	8,40
117450601	M122512	12	10,50

TENGOOLS



Dopbits 1/2" met TPX-bits. Korte uitvoering, chroom vanadium. Matverchromde uitvoering. L. 55mm.

Order nr.	Orig. nr.	Maat TPX	Prijs €
68250109	M121220	20	6,40
68250208	M121225	25	6,40
68250307	M121227	27	6,40
68250406	M121230	30	6,40
68250505	M121240	40	6,40
68250604	M121245	45	6,40
68250703	M121250	50	6,40
68250802	M121255	55	6,90
68250901	M121260	60	8,30

TENGOOLS



Dopbits 1/2" met TX-bits. Korte uitvoering, chroom vanadium. Matverchromde uitvoering. L. 55mm.

Order nr.	Orig. nr.	Maat TX	Prijs €
117400101	M121220T	20	5,50
117400200	M121225T	25	5,50
117400309	M121227T	27	5,50
117400408	M121230T	30	5,50
117400507	M121240T	40	5,50
117400606	M121245T	45	6,00
117400705	M121250T	50	6,00
117400804	M121255T	55	6,40
117400903	M121260T	60	7,30

TENGOOLS



Dopbits 1/2" met TX-bits. Lange uitvoering, MM uitvoering, chroom vanadium. Matverchromde uitvoering. L. 100mm.

Order nr.	Orig. nr.	Maat TX	Prijs €
117440107	M122220T	20	8,20
117440206	M122225T	25	8,20
117440305	M122227T	27	8,20
117440404	M122230T	30	8,20
117440503	M122240T	40	8,20
117440602	M122245T	45	8,80
117440701	M122250T	50	8,80
117440800	M122255T	55	10,50
117440909	M122260T	60	11,50
117441006	M122270T	70	11,50

TENGOOLS



Dopbits 1/2" met Ribe-bits. Lange uitvoering, chroom vanadium. Matverchromde uitvoering. L. 100mm.

Order nr.	Orig. nr.	Maat Ribe	Prijs €
143990109	M122704	4	6,20
143990208	M122705	5	6,20
143990307	M122706	6	6,20
143990406	M122708	8	6,20
143990505	M122710	10	8,00
143990604	M122711	11	9,70
143990703	M122712	12	10,50
143990802	M122713	13	11,50

TENGOOLS



Dopbits 1/2" met Spline-bits. Lange uitvoering, Chroom vanadium. Matverchromde uitvoering. L. 100mm. (voor X2N schroeven).

Order nr.	Orig. nr.	Maat Spline	Prijs €
144000106	M122805	5	6,40
144000205	M122806	6	6,40
144000304	M122808	8	6,40
144000403	M122810	10	8,30
144000502	M122812	12	9,70
144000601	M122814	14	11,00
144000700	M122816	16	11,50

TENGOOLS



Dop 1/2" TX-E. Korte uitvoering, chroom vanadium. Matverchromde uitvoering. L. 38mm.

Order nr.	Orig. nr.	Maat TX-E	Prijs €
112070107	M120710	10	4,80
112070206	M120711	11	4,80
112070305	M120712	12	4,80
112070404	M120714	14	4,80
112070503	M120716	16	4,80
112070602	M120718	18	6,40
112070701	M120720	20	6,40
112070800	M120722	22	6,40
112070909	M120724	24	6,40

TENGOOLS



Dopbits 1/2" met Hex-bits.
Extra lange uitvoering. mm-
uitvoering. chroom vanadium.
Matverchroomde uitvoering.

Order nr.	Orig. nr.	Maat mm	L1 mm	L2 mm	Diameter mm	Prijs €
186730107	M122506A	6	115	80	22	8,00
186730206	M122508A	8	115	80	22	8,00
186730305	M122510A	10	175	140	22	9,10

Doppen 3/4"

TENGOOLS



Dop 3/4" 6-kant. Korte uitvoering.
mm-uitvoering. DIN 3124-
ISO 2725. chroom vanadium.
Matverchroomde uitvoering.

Order nr.	Orig. nr.	Maat mm	Lengte mm	Prijs €
36200103	M3405196	19	50	12,50
36200202	M3405216	21	50	12,50
36200301	M3405226	22	50	12,50
36200400	M3405246	24	51	12,50
36200509	M3405276	27	52	14,50
36200608	M3405306	30	54	15,50
36200707	M3405326	32	56	16,90
36200806	M3405336	33	56	16,50
36200905	M3405346	34	56	17,90
36201002	M3405366	36	58	18,90
36201101	M3405386	38	60	20,50
36201200	M3405416	41	64	24,50
36201309	M3405466	46	68	27,50
36201408	M3405506	50	72	31,90

TENGOOLS



Dop 3/4" 12-kant. Korte
uitvoering. AF-uitvoering.
DIN 3124-ISO 2725. chroom
vanadium. Matverchroomde
uitvoering.

Order nr.	Orig. nr.	Lengte mm	Maat inch	Prijs €
114930100	M340124	50	3/4	9,60
114930209	M340128	51	7/8	9,00
114930308	M340130	51	15/16	9,00
114930407	M340132	51	1	9,90
114930506	M340134	51	1 1/16	9,90
114930605	M340136	51	1 1/8	10,50
114930704	M340138	53	1 3/16	11,00
114930803	M340140	55	1 1/4	10,50
114930902	M340142	55	1 5/16	12,50
114931009	M340144	57	1 3/8	12,50
114931108	M340146	57	1 7/16	13,50
114931207	M340148	57	1 1/2	14,50
114931306	M340152	63	1 5/8	15,90
114931405	M340156	65	1 3/4	17,50
114931504	M340158	67	1 13/16	16,50
114931603	M340160	69	1 7/8	18,90
114931702	M340164	71	2	20,50

Doppen 1"

TENGOOLS



Dop 1" 12-kant. Korte uitvoering.
DIN 3124-ISO 2725. chroom
vanadium. Matverchroomde
uitvoering.

Order nr.	Orig. nr.	Maat	Lengte mm	Prijs €
114840101	M110536	36mm	65	21,50
114840200	M110541	41mm	70	23,50
114840309	M110546	46mm	74,5	28,00
114840408	M110550	50mm	75,3	29,50
114840507	M110555	55mm	80	39,50
114840606	M110558	58mm	80	36,50
114840705	M110560	60mm	84	40,90
114840804	M110565	65mm	87,3	56,50
114840903	M110570	70mm	93,4	61,50
114841000	M110575	75mm	96	66,50
114841109	M110580	80mm	103,6	80,90



Slagdoppen

TENGOOLS



Set van 3 lange slagdoppen 1/2" 6-kant metrisch. Chroom molybdeen kwaliteit. Voorzien van een kunststof beschermingshuls over de slagdoppen voor het gebruik bij o.a. alu-velgen.

Order nr.	118870104		
Orig. nr.	9203N		
Lengte	mm	85	
Maten	mm	17, 19, 21	
Prijs	€	43,50	

TENGOOLS

Losse Slagdoppen uit 9203N.

Order nr.	118350107	118350206	118350305
Orig. nr.	920517N	920519N	920521N
Maat	mm	17	19
Lengte	mm	85	85
Prijs	€	15,50	15,50

TENGOOLS



Slagdoppenset voor wielmoeren. Bestaat uit twee omkeerbare 1/2" doppen met verschillende maten aan beide uiteinden en een verlengstuk met opname 1/2".

Order nr.	186370102		
Orig. nr.	9203N1		
Maten doppen	mm	17x19 - 21x22	
Lengte verlengstuk	mm	75	
Prijs	€	21,00	

TENGOOLS



Slagdoppenset 6-kant bestaande uit 8 of 10 korte slagdoppen. Geleverd op een metalen rail met dopclips.

Order nr.	75240101	75240200
Orig. nr.	9381	9121
Doppen 1/2"	mm	10 - 11 - 12 - 13 - 14 - 17 - 19 - 21 - 22 - 24
Aantal stuks		8
Doppen 3/8"	mm	8 - 10 - 11 - 13 - 14 - 16 - 17 - 19
Prijs	€	17,50

TENGOOLS



Set bestaande uit 8 of 10 lange slagdoppen 6-kant. Geleverd op een metalen rail met dopclips.

Order nr.	114960107	114960206
Orig. nr.	9386	9126
Doppen 1/2"	mm	10 - 11 - 12 - 13 - 14 - 17 - 19 - 21 - 22 - 24
Aantal stuks		8
Doppen 3/8"	mm	8 - 10 - 11 - 13 - 14 - 16 - 17 - 19
Prijs	€	24,50

TENGOOLS



24-delige slagdoppenset. Bestaat uit 24 slagdoppen gaande van 6 tot 19mm waarvan 5 korte slagdoppen 1/4", 9 korte slagdoppen 3/8", 9 lange slagdoppen 3/8" en 1 adaptor 3/8"-1/4". TC-Tray.

Order nr.	132470105		
Orig. nr.	TT9024		
Doppen 3/8"	mm	8 - 10 - 11 - 12 - 13 - 14 - 15 - 16 - 17 - 19	
Doppen 1/4"	mm	6 - 7 - 8 - 10 - 13	
Doppen 3/8" lang	mm	8 - 10 - 11 - 12 - 13 - 14 - 15 - 16 - 17 - 19	
Adaptor	inch	3/8 - 1/4	
Prijs	€	59,50	

TENGOOLS



16-delige korte en lange doppenset 1/2" ANSI gaande van 13 tot 24mm. TC-Tray.

Order nr.	68800101		
Orig. nr.	TT9116		
Doppen 1/2"	mm	13 - 15 - 16 - 17 - 18 - 19 - 22 - 24	
Doppen 1/2" lang	mm	13 - 15 - 16 - 17 - 18 - 19 - 22 - 24	
Prijs	€	59,90	

TENGOOLS



Set van 16 korte en lange slagdoppen 1/2" gaande van 13 tot 24mm, 2 vasthoudpinnen en 2 O-ringen. Conform DIN-standaard. TC-tray.

Order nr.	143840106		
Orig. nr.	TT9120D		
Doppen 1/2" 6-kant	mm	13 - 15 - 16 - 17 - 18 - 19 - 22 - 24	
Doppen 1/2" 6-kant lang	mm	13 - 15 - 16 - 17 - 18 - 19 - 22 - 24	
Vasthoudpinnen	mm	20X3,5 - 25X3,5	
O-ringen	mm	3x20 - 3x24	
Prijs	€	80,90	

TENGOOLS



7-delige set slagdopaccessoires 1/2" bestaande uit 3 verlengstukken, universele elleboog 1/2", 3 adaptors. TC-tray.

Order nr.	132460106 T		
Orig. nr.	TT9207		
Verlengstukken	mm	75 - 125 - 250	
Universele koppeling	inch	1/2	
Adaptors	inch	1/23/4 - 3/8-1/2 - 1/23/8	
Prijs	€	54,50	

TENGOOLS



Set van 12 slagdopbitsen 1/2" gaande van TX10 tot TX70. TC-tray.

Order nr.	128130101 T		
Orig. nr.	TT9212TX		
Slagbitsen	TX	10 - 15 - 20 - 25 - 27 - 30 - 40 - 45 - 50 - 55 - 60 - 70	
Prijs	€	92,90	

TENGOOLS



Set van 15 hex slagdoppen 3/8" en 1/2" gaande van 4 tot 19mm. TC-tray.

Order nr.	151410107 T		
Orig. nr.	TT9015HX		
Dopbitsen 1/2" Hex	mm	5 - 6 - 8 - 10 - 12 - 14 - 17 - 19	
Dopbitsen 3/8" hex	mm	4 - 5 - 6 - 7 - 8 - 10 - 12	
Afmetingen (l x b x h)	mm	265 x 142 x 50	
Prijs	€	98,90	

TENGOOLS



16-delige slagdoppenset. Bestaat uit 9 korte slagdoppen gaande van 19 tot 38mm en 1 verlengstuk. TC-tray.

Order nr.	160690103 T		
Orig. nr.	TTD9416		
Doppen 3/4" 6-kant	mm	19 - 24 - 27 - 30 - 32 - 33 - 34 - 36 - 38	
Verlengstuk	mm	175	
Vasthoudpinnen	mm	4x37 (x2)	
O-ringen	mm	38x3,5 (x3)	
Afmetingen (l x b x h)	mm	260 x 280 x 80	
Prijs	€	108,00	

TENGOOLS



Set van 15 korte en lange slagdoppen 3/4" gaande van 19 tot 36mm. TTX-tray.

Order nr.	122080104 T		
Orig. nr.	TTX9415		
Slagdoppen 3/4"	mm	19 - 24 - 27 - 28 - 30 - 32 - 34 - 36	
Slagdoppen 3/4" lang	mm	19 - 24 - 27 - 30 - 32 - 33 - 36	
Prijs	€	175,00	

TENGOOLS



20-delige set bestaande uit 1 slagschroevendraaier 1/2", bitshouder 1/2"-5/16", adaptor 3/8"-M-5/16"Hex en 17 slagbitsen L.36mm. TC-tray.

Order nr.	102100104 T		
Orig. nr.	TTID20		
Slagbitsen Plat	mm	6 - 8 - 10 - 12	
Slagbitsen PH		1 - 2 - 3 - 4	
Adaptor	inch	3/8-5/16	
Slagbitsen Hex	mm	4 - 5 - 6 - 8	
Slagbitsen TX		30 - 40 - 45 - 50 - 55	
Prijs	€	28,50	

TENGOOLS



6-delige slagschroevendraaiersset. Bestaat uit 1 industriële slagschroevendraaier 1/2", 1 slagbitshouder van 1/2" naar 5/16" en 4 slagbitsen 5/16" plat en Ph. Deze slagschroevendraaier kan werken in de twee richtingen. Geleverd in een PVC doosje.

Order nr.	03120102 T		
Orig. nr.	ID506		
Slagbitsen Plat	mm	1,4x8 - 2,2x10	
Slagbitsen PH		2 - 3	
Prijs	€	35,90	

TENGOOLS



Set aparte slagbitsen voor 03120102.

Order nr.	03120201 T		
Orig. nr.	ID506BIT		
Prijs	€	6,10	

TENGOOLS



15-delige slagschroevendraaierset. Bestaande uit 1 professionele slagschroevendraaier 1/2", 1 slagbitshouder van 1/2" naar 5/16" en 12 slagbitsen 5/16". Deze slagschroevendraaier kan werken in de twee richtingen. Geleverd in een kunststof doosje.

Order nr.	72660103		
Orig. nr.	ID515		
Slagbitsen Plat	mm	1,4x6 - 1,4x8 - 2,2x10	
Slagbitsen PH		1 - 2 - 3 - 4	
Slagbitsen Hex		4 - 5 - 6 - 8	
Prijs	€	31,90	

TENGOOLS



Set aparte slagbitsen voor 72660103.

Order nr.	72660202		
Orig. nr.	ID515BIT		
Prijs	€	11,50	

TENGOOLS



Slagbitsen 5/16" aandrijfkant. L.36mm.

Order nr.	Orig. nr.	Maat Hex mm	Maat PH	Maat PZ	Maat TX	Maat plat mm	Prijs €
116480104	910504	4					1,40
116480203	910505	5					1,40
116480302	910506	6					1,40
116480401	910508	8					1,40
186720109	910510	10					1,50
116480500	940006					6	1,40
116480609	940008					8	1,40
116480708	940010					10	1,40
116480807	940012					12	1,40
116480906	930001		1				1,40
116481003	930002		2				1,40
116481102	930003		3				1,40
116481201	930004		4				1,40
132230103	920001			1			0,90
132230202	920002			2			0,90
132230301	920003			3			0,90
149870107	970030				30		1,30
149870206	970040				40		1,30
149870305	970045				45		1,30
149870404	970050				50		1,30
149870503	970055				55		1,30

TENGOOLS



Slagbitshouders.

Order nr.	116690207	102100203	116691007
Orig. nr.	980060	980086	920060
Aansluiting	inch 3/8	3/8	1/2
Voor bitsen	inch 1/4	5/16	5/16
Prijs	€ 7,10	2,00	7,10

TENGOOLS



Slagdopadaptors en Verloopstukken. Zonder kogel.

Order nr.	Orig. nr.	O-ringen	Pin nummer	Omschrijving	Aansluiting inwendig inch	Prijs €
116690850	980035	O92419	P902518	verkleiner 3/8 - 1/4	3/8	7,50
116690108	980036-C	O92419	P902518	vergroter 3/8 - 1/2	3/8	11,50
116690801	920036	O935202	P90320	verkleiner 1/2 - 3/8	1/2	9,00
116690900	920037	O935202	P90320	vergroter 1/2 - 3/4	1/2	13,50
116691304	940037	O93538	P90437	verkleiner 3/4 - 1/2	3/4	18,50
116691403	940085	O93538	P90437	vergroter 3/4 - 1	3/4	26,50
116691502	910086	O93546	P90543	verkleiner 1 - 3/4	1	26,00

TENGOOLS



Universele elleboogstukken voor slagdoppen. Zonder kogel.

Order nr.	116690702	116691205
Orig. nr.	920030	940030
O-ringen	Nr. O93528	O93538
Pin nummer	P90328	P90437
Aansluiting inwendig	inch 1/2	3/4
Prijs	€ 17,90	56,50

TENGOOLS



Verlengstukken voor slagdoppen. Met kogel.

Order nr.	Orig. nr.	O-ringen mm	Aansluiting inch	Pin mm	Omschrijving	Prijs €
160720108	920020A-C	0935202	1/2	P90320	75mm	7,70
160720207	920021A-C	0935202	1/2	P90320	125mm	10,50
160720306	920023A-C	0935202	1/2	P90320	250mm	20,50
160720405	920030A-C	093528	1/2	P90328	universele aansluiting	18,50
160720504	920037A-C	0935202	1/2	P90320	adaptor 1/2"-3/4"	10,50
160940102	980036A-C	092413	3/8	P902515	adaptor 3/8"-1/2"	7,30

TENGOOLS



Verlengstukken voor slagdoppen. Zonder kogel.

Order nr.	Orig. nr.	O-ringen Nr.	Pin nummer	Lengte mm	Aansluiting inch	Prijs €
116690058	980020	092416	P902515	75	3/8	8,30
116690405	920020	0935202	P90320	75	1/2	9,90
116690504	920021	0935202	P90320	125	1/2	12,50
116690603	920023	0935202	P90320	250	1/2	20,50
116691106	940022	093538	P90437	175	3/4	33,50

TENGOOLS



Vasthouding voor slagdoppen. Om slagdoppen en gereedschappen op slagmoersleutels met geperforeerd aansluitvierkant te bevestigen. Zorgt ervoor dat de bevestigingspin niet uit het aansluitvierkant kan vallen.

Order nr.	Orig. nr.	Diameter x dikte mm	Prijs €
116740051	092416	16x2,4	1,00
116740085	092419	19x2,4	1,00
116740101	0935202	20x3,5	1,00
116740200	093525	25x3,5	1,00
116740309	093528	28x3,5	1,00
116740333	093530	30x3,5	1,00
116740358	093532	32x3,5	1,00
116740382	093534	34x3,5	1,00
116740408	093538	38x3,5	1,00
116740507	093546	46x3,5	1,40
116740606	093548	48x3,5	1,40
116740705	0970055	75x5,7	2,50

TENGOOLS



Vasthoudpin voor slagdoppen. Om slagdoppen en gereedschappen op slagmoersleutels met geperforeerd aansluitvierkant te bevestigen.

Order nr.	Orig. nr.	Diameter x lengte mm	Prijs €
116750050	P902515	2,5x15	1,80
116750084	P902518	2,5x18	1,80
116750100	P90320	3x20	1,80
116750209	P90324	3x24	1,80
116750308	P90328	3x28	1,80
116750357	P90332	3x32	1,80
116750407	P90437	4x37	1,80
116750506	P90543	5x43	2,60

TENGOOLS



Slagdrop 1/4" aansluiting 6-kant. Chrom molybdeen kwaliteit. Lengte 21mm.

Order nr.	Orig. nr.	Maat mm	Prijs €
132430109	960506-C	6	2,80
132430208	960507-C	7	2,80
132430307	960508-C	8	2,80
132430406	960510-C	10	3,10
132430505	960513-C	13	3,50

TENGOOLS



Slagdoppen 3/8" hex chrom molybdeen kwaliteit. L.52mm.

Order nr.	Orig. nr.	Maat mm	O-ringen Nr.	Pin nummer	Prijs €
151430105	981504-C	4	0935202	P90320	9,50
151430204	981505-C	5	0935202	P90320	9,50
151430303	981506-C	6	0935202	P90320	9,50
151430402	981507-C	7	0935202	P90320	9,50
151430501	981508-C	8	0935202	P90320	9,50
151430600	981510-C	10	0935202	P90320	9,90
151430709	981512-C	12	0935202	P90320	9,90

TENGTOLS



Slagdoppen 3/8" 6-kant. Conform ANSI-standaard. Korte versie L. 30mm. mm-uitvoering. chroom molybdeen kwaliteit. De doppen zijn voorzien van een opening voor de vasthoudpin.

Order nr.	Orig. nr.	Maat mm	Prijs €
114830102	980508	8	3,40
114830201	980510	10	3,70
114830300	980511	11	3,70
114830409	980512	12	3,80
114830508	980513	13	4,10
114830607	980514	14	5,20
114830706	980516	16	5,60
114830805	980517	17	5,60
114830904	980519	19	6,10

TENGTOLS



Slagdoppen 3/8" 6-kant. Conform ANSI-standaard. Lange versie L. 65mm. mm-uitvoering. chroom molybdeen kwaliteit. De doppen zijn voorzien van een opening voor de vasthoudpin.

Order nr.	Orig. nr.	Maat mm	Prijs €
114860109	980608	8	6,10
114860208	980610	10	6,80
114860307	980611	11	6,80
114860406	980612	12	6,80
114860505	980613	13	7,00
114860604	980614	14	7,40
114860703	980616	16	7,70
114860802	980617	17	7,70
114860901	980619	19	8,20

TENGTOLS



Slagdoppen 1/2" 6-kant. Conform DIN-standaard. Korte versie. mm en inch uitvoering. chroom molybdeen kwaliteit. De doppen zijn voorzien van een opening voor de vasthoudpin met sleuf voor ring. (Dit zijn de losse doppen uit de Teng Tray TT9120D).

Order nr.	Orig. nr.	Maat mm	O-ringen Nr.	Pin nummer	Lengte mm	Maat inch	Prijs €
101780021	920508-C	8	O935202	P90320	38		5,90
101780039	920510	10	O935202	P90320	38		5,90
101780062	920511	11	O935202	P90320	38		5,90
101780096	920512	12	O935202	P90320	38		6,40
101780104	920513	13	O935202	P90320	38		6,90
101780153	920514	14	O935202	P90320	38		6,90
101780203	920515	15	O93525	P90324	38		7,00
101780302	920516	16	O93525	P90324	38		7,70
101780401	920517	17	O93525	P90324	38		8,10
101780500	920518	18	O93525	P90324	38		8,10
101780609	920519	19	O93525	P90324	38		8,10
101780633	920520	20	O93525	P90324	38		8,10
101780658	920521	21	O93525	P90324	38		8,40
101780708	920522	22	O93525	P90324	38		8,80
101780757	920523	23	O93525	P90324	38		8,80
101780807	920524	24	O93525	P90324	38		10,50
101780815	920525-C	25	O93525	P90324	45		10,50
101780823	920526-C	26	O93525	P90324	50		11,50
101780831	920527-C	27	O93525	P90324	50		11,90
101780849	920528-C	28	O93525	P90324	50		11,90
101780856	920529-C	29	O93525	P90324	50		12,50
101780864	920530-C	30	O93525	P90324	50		12,50
101780872	920532	32	O93525	P90324	50		12,50
114870108	920114		O935202	P90320	38	7/16	6,10
114870207	920116		O935202	P90320	38	1/2	6,80
114870306	920118		O935202	P90320	38	9/16	6,80
114870405	920120		O935202	P90320	38	5/8	6,80
114870504	920122		O935202	P90320	38	11/16	7,40
114870603	920124		O935202	P90320	38	3/4	8,10
114870702	920126		O935202	P90320	38	13/16	8,80
114870801	920128		O935202	P90320	38	7/8	8,80
114870900	920130		O93530	P90328	38	15/16	10,50
114871007	920132		O93532	P90328	38	1	10,50

TENGOOLS



Slagdoppen 1/2" 6-kant. Conform DIN-standard. Lange versie. mm en inch uitvoering. L. 78mm. chroom molybdeen kwaliteit. De doppen zijn voorzien van een opening voor de vasthoudpin met sleuf voor ring. (Dit zijn de losse doppen uit de Teng Tray TT9120D).

Order nr.	Orig. nr.	Maat mm	O-ringen Nr.	Pin nummer	Maat inch	Prijs €
101780930	920610	10	O935202	P90320		10,50
101780963	920611	11	O935202	P90320		10,50
101780997	920612	12	O935202	P90320		10,50
101781003	920613	13	O935202	P90320		10,50
101781052	920614	14	O935202	P90320		11,50
101781102	920615	15	P93525	P902324		12,00
101781201	920616	16	O93525	P902324		12,00
101781300	920617	17	O93525	P902324		11,90
101781409	920618	18	O93525	P902324		12,00
101781508	920619	19	O93525	P902324		11,90
101781557	920621	21	O93525	P902324		12,00
101781607	920622	22	O93525	P902324		12,50
101781706	920624	24	O93525	P902324		13,50
101781805	920627	27	O93525	P902324		14,50
101781904	920628	28	O93525	P902324		15,50
101782001	920629	29	O93525	P902324		15,50
101782100	920630	30	O93525	P902324		17,50
101782209	920632	32	O93525	P902324		17,50
101782308	920635	35	O93525	P902324		21,50
101782407	920636	36	O93525	P902324		22,50
114872005	920214		O935202	P90320	7/16	10,90
114872104	920216		O935202	P90320	1/2	11,50
114872203	920218		O935202	P90320	9/16	11,50
114872302	920220		O935202	P90320	5/8	12,00
114872401	920222		O935202	P90320	11/16	13,50
114872500	920224		O935202	P90320	3/4	14,50
114872609	920226		O935202	P90320	13/16	14,50
114872708	920228		O935202	P90320	7/8	15,50
114872807	920230		O93530	P93028	15/16	15,50
114872906	920232		O93532	P93028	1	15,90
114873003	920242		O93534	P93032	1 5/16	21,50
114873102	920248		O93534	P93032	1 1/2	24,50

TENGOOLS



Slagdoppen 1/2" 6-kant. Conform ANSI-standard. Korte en lange versie. Mm-uitvoering. chroom molybdeen kwaliteit. Dunwandig. (Dit zijn de losse doppen uit de Teng Tray TT9116).

Order nr.	Orig. nr.	Maat mm	Lengte mm	Prijs €
132450107	920513A	13	38	4,00
132450206	920515A	15	38	4,40
132450305	920516A	16	38	4,20
132450404	920517A	17	38	4,60
132450503	920518A	18	38	4,20
132450602	920519A	19	38	6,50
132450701	920522A	22	38	5,50
132450800	920524A	24	38	5,10
132440108	920613A	13	78	6,40
132440207	920615A	15	78	6,80
132440306	920616A	16	78	6,80
132440405	920617A	17	78	6,80
132440504	920618A	18	78	6,80
132440603	920619A	19	78	7,30
132440702	920622A	22	78	8,10
132440801	920624A	24	78	7,60

TENGOOLS



Dunwandige metrische slagdoppen. 6-kant. Chroom-molybdeen staal. Met 6-punt openingen. Zwart. L 38 mm.

Order nr.	Orig. nr.	Prijs €
132450057	920510A	3,80
132450073	920511A	3,80
132450081	920512A	3,80
132450156	920514A	3,80
132450651	920521A	4,90

TENGOOLS



Slagdrop lang 1/2 dunwandig. 6-kant. Chroom-molybdeen staal. L 78mm.

Order nr.	Orig. nr.	Prijs €
132440058	920610A	5,80
132440074	920611A	5,80
132440082	920612A	5,80
132440157	920614A	6,10
132440652	920621A	7,70

TENGTTOOLS



Slagdoppen 1 1/2 6-kant.

Order nr.	Orig. nr.	Maat mm	Lengte mm	Prijs €
172840100	912041	41	69	114,00
172840209	912046	46	75	114,00
172840308	912050	50	80	120,00
172840407	912055	55	86	133,00
172840506	912060	60	91	144,00
172840605	912065	65	97	152,00
172840704	912070	70	104	177,00
172840803	912075	75	110	189,00
172840902	912080	80	116	208,00
172841009	912085	85	123	219,00
172841108	912090	90	129	382,00
172841207	912095	95	136	595,00
172841306	912100	100	142	695,00
172841405	912105	105	148	725,00
172841304	912110	110	154	799,00
172841403	912115	115	161	855,00
172841502	912120	120	167	875,00
172841601	912125	125	173	915,00
172841700	912130	130	180	929,00

TENGTTOOLS



Slagdopbitsen 1/2" hex voor interne openingen. Lange versie L.78mm. Chroom molybdeen kwaliteit. De doppen zijn voorzien van een opening voor de vasthoudpin.

Order nr.	Orig. nr.	Maat mm	O-ringen Nr.	Pin nummer	Prijs €
151420106	921505-C	5	O935202	P90320	12,50
151420205	921506-C	6	O935202	P90320	12,50
151420304	921508-C	8	O935202	P90320	12,50
151420403	921510-C	10	O935202	P90320	13,50
151420502	921512-C	12	O935202	P90320	13,50
151420601	921514-C	14	O935202	P90320	13,50
151420700	921517-C	17	O935202	P90320	13,90
151420809	921519-C	19	O935202	P90320	13,90

TENGTTOOLS



Slagdopbitsen TX 1/2". Lange versie L.78mm. chroom molybdeen kwaliteit. De doppen zijn voorzien van een opening voor de vasthoudpin.

Order nr.	Orig. nr.	O-ringen Nr.	Pin nummer	Maat TX	Prijs €
128140100	921210TX-C	O935202	P90320	10	14,50
128140209	921215TX-C	O935202	P90320	15	14,50
128140308	921220TX-C	O935202	P90320	20	12,50
128140407	921225TX-C	O935202	P90320	25	12,50
128140506	921227TX-C	O935202	P90230	27	12,50
128140605	921230TX-C	O935202	P90230	30	11,90
128140704	921240TX-C	O935202	P90230	40	11,90
128140803	921245TX-C	O935202	P90230	45	11,90
128140902	921250TX-C	O935202	P90230	50	11,90
128141009	921255TX-C	O935202	P90230	55	12,50
128141108	921260TX-C	O935202	P90230	60	12,50
128141207	921270TX-C	O935202	P90230	70	12,50

TENGTTOOLS



Torsiestaaf. Voor het vastzetten van wielmoeren met slagmoeraanzetters.

Order nr.	Orig. nr.	Voor moer Nm	Kant inch	Prijs €
172510109	923090	90	1/2	17,50
172510208	923110	110	1/2	17,50
172510307	923120	120	1/2	17,50
172510406	923140	140	1/2	17,50

TENGOOLS



Slagdoppen 3/4" 6-kant metrisch. Conform DIN-standaard. Korte en lange versie. Chroom molybdeen kwaliteit. De doppen zijn voorzien van een opening voor de vasthoudpin.

Order nr.	Orig. nr.	Maat mm	O-ringen Nr.	Pin nummer	Lengte mm	Prijs €
114880107	T 940519	19	O93538	P90437	50	15,50
114880156	T 940521	21	O93538	P90437	50	15,50
114880172	T 940522	22	O93538	P90437	50	15,50
114880198	T 940523	23	O93538	P90437	50	15,50
114880206	T 940524	24	O93538	P90437	52	17,50
114880305	T 940527	27	O93538	P90437	52	17,50
114880404	T 940528	28	O93538	P90437	52	15,50
114880503	T 940530	30	O93538	P90437	52	17,50
114880602	T 940532	32	O93538	P90437	52	18,00
114880701	T 940533	33	O93538	P90437	56	20,50
114880800	T 940534	34	O93538	P90437	56	20,50
114880909	T 940536	36	O93538	P90437	56	21,50
114881006	T 940538	38	O93538	P90437	56	22,90
114881105	T 940541	41	O93538	P90437	58	27,50
114881204	T 940546	46	O93538	P90437	63	34,50
114890106	T 940619	19	O93538	P90437	95	25,50
114890155	T 940621	21	O93538	P90437	95	23,50
114890171	T 940622	22	O93538	P90437	95	23,50
114890197	T 940623	23	O93538	P90437	95	23,50
114890205	T 940624	24	O93538	P90437	95	24,50
114890304	T 940627	27	O93538	P90437	95	24,50
114890403	T 940630	30	O93538	P90437	95	24,00
114890502	T 940632	32	O93538	P90437	95	24,50
114890601	T 940633	33	O93538	P90437	95	28,90
114890700	T 940634	34	O93538	P90437	95	30,50
114890809	T 940636	36	O93538	P90437	95	31,50
114890908	T 940638	38	O93538	P90437	95	31,50
114891005	T 940641	41	O93538	P90437	95	33,50
114891104	T 940646	46	O93538	P90437	95	50,50

TENGOOLS



Slagdopbits 3/4" Hex. chroom-molybdeen kwaliteit. Voor interne hex openingen. L. 90mm.

Order nr.	143980100	T 143980209	T 143980308
Orig. nr.	941519C	941522C	941524C
Maat mm	19	22	24
O-ringen Nr.	O93538	O93538	O93538
Pin nummer	P90437	P90437	P90437
Prijs €	39,90	39,90	40,90

TENGOOLS



Slagdoppen 1" 6-kant. Conform DIN-standaard. Korte versie. mm-uitvoering. chroom molybdeen kwaliteit. De doppen zijn voorzien van een opening voor de vasthoudpin.

Order nr.	Orig. nr.	Maat mm	O-ringen Nr.	Pin nummer	Lengte mm	Prijs €
114900103	T 910524	24	O93546	P90543	58	31,90
114900202	T 910527	27	O93546	P90543	58	31,90
114900301	T 910530	30	O93546	P90543	60	31,90
114900400	T 910532	32	O93546	P90543	60	31,90
114900509	T 910533	33	O93546	P90543	60	31,90
114900608	T 910534	34	O93546	P90543	60	31,90
114900707	T 910536	36	O93546	P90543	65	32,90
114900806	T 910538	38	O93546	P90543	65	31,90
114900905	T 910541	41	O93546	P90543	67	30,50
114901002	T 910546	46	O93546	P90543	74	37,50
114901101	T 910550	50	O93546	P90543	80	46,00
114901200	T 910555	55	O93546	P90543	84	58,50
114901309	T 910560	60	O93546	P90543	87	64,50
114901408	T 910565	65	O93546	P90543	90	79,90
114901507	T 910570	70	O93546	P90543	96	79,90
114901606	T 910575	75	O93546	P96075	98	115,00
114901705	T 910580	80	O95775	P96075	100	117,00
114901804	T 910585	85	O95775	P96075	100	127,00
114901903	T 910590	90	O95775	P96075	105	150,00
114902000	T 910595	95	O95775	P96075	105	169,00

TENGOOLS



Slagdoppen 1" 6-kant metrisch. Lange versie. L 100mm. chroom molybdeen kwaliteit.

Order nr.	Orig. nr.	Maat mm	O-ringen Nr.	Pin nummer	Prijs €
114920101	T 910627R	27	O93546	P90543	39,50
114920200	T 910630R	30	O93546	P90543	38,50
114920309	T 910632R	32	O93546	P90543	38,50
114920408	T 910633R	33	O93546	P90543	38,50

TENGOOLS



Slagdoppen 1". Dunwandig model. Lange versie L.100mm. 6-kant metrisch. chroom molybdeen kwaliteit.

Order nr.	Orig. nr.	Maat mm	O-ringen Nr.	Pin nummer	Prijs €
114910102	T 910624	24	O93546	P90543	65,90
114910201	T 910627	27	O93546	P90543	65,90
114910300	T 910630	30	O93546	P90543	64,90
114910409	T 910632	32	O93546	P90543	65,90
114910508	T 910633	33	O93546	P90543	65,90
801200375	T T910634	34	O93546	P90543	54,00
114910607	T 910636	36	O93546	P90543	65,90

Doppen-sets



- Nieuw inklapbaar handvat speciaal ontworpen voor comfort en duurzaamheid

- Nieuw verbeterd vergrendelingsysteem met click lock mechanisme, om zeker te zijn dat uw koffer goed dicht is

- Verdelers beschermen de werktuigen en kunnen dankzij een scharnier gedraaid worden, voor een gemakkelijke toegang tot de werktuigen

- Nieuwe sterke scharnieren met metalen staven voor een langere duurzaamheid

- Mooie reliëfmarkering om met uw Teng Tools set uit te pakken

- Rubberen voeten om glijden en krassen te vermijden

- Duidelijke en eenvoudige indeling van de werktuigen, zodat u rechtstreeks kunt zien welke ontbreken na het einde van een werk

- Volledig recycleerbare verpakking voor milieubescherming



Nieuwe generatie Teng Tools dopensets

De nieuwe generatie dopensets biedt u een gloed-nieuwe koffer met voordelen die uw dagelijkse werk zullen vergemakkelijken.

Bij het ontwerp van de nieuwe koffer hebben we de nadruk gelegd op handigheid, duurzaamheid en gemak van transport. Bovendien oogt hij ook mooi ...





Doppensets 1/4"

TENGOOLS



19-delige mini doppenset 1/4" 6-kant. Bestaande uit 6 doppen 1/4" gaande van 8 tot 13mm, 1 mini-handratel 1/4", 1 bitshouder en 10 bitsen. Geleverd in een kunststof doos met klikslot.

Order nr.	167340108		
Orig. nr.	T1419		
Aantal stuks	19		
Bitsen plat	mm	4,5 - 5,5 - 6,5	
Bitsen PH	1 - 2		
Bitsen PZ	1 - 2		
Bitsen Hex	mm	4 - 5 - 6	
Doppen 1/4" 6-kant	mm	8 - 9 - 10 - 11 - 12 - 13	
Prijs	€	24,90	

TENGOOLS



20-delige mini doppenset 1/4". Bestaande uit 7 doppen 1/4" 6-kant gaande van 5,5 tot 13mm, 1 mini-handratel 1/4", 1 bitshouder en 10 bitsen. Geleverd in een kunststof doos met klikslot.

Order nr.	167350107		
Orig. nr.	T1420		
Aantal stuks	20		
Bitsen plat	mm	4,5 - 5,5 - 6,5	
Bitsen PH	1 - 2		
Bitsen TX	10 - 15 - 20		
Bitsen PZ	1 - 2		
Doppen 1/4" 6-kant	mm	5,5 - 6 - 7 - 8 - 9 - 10 - 13	
Prijs	€	25,50	

TENGOOLS



23-delige mini doppenset 1/4" 6-kant bestaande uit 9 doppen 1/4" gaande van 4 tot 13mm, 1 mini bitsratel, 1 schroefsleutel 100mm, 1 verlengstuk L. 50mm en 10 bitsen. Geleverd in een kunststof doos met klikslot.

Order nr.	167330109		
Orig. nr.	T1423		
Aantal stuks	23		
Bitsen plat	mm	4 - 5,5 - 6,5	
Bitsen PH	1 - 2		
Bitsen TX	10 - 15 - 20		
Bitsen PZ	1 - 2		
Doppen 1/4" 6-kant	mm	4 - 5 - 5,5 - 6 - 7 - 8 - 10 - 12 - 13	
Accessoires 1/4"	2" verlengstuk - 1/4 bitsratel - 1/4 M: 1/4 hex adaptor		
Sleutels	inch	schroefsleutel 4"	
Prijs	€	34,90	

TENGOOLS



24-delige Mini doppenset 1/4". Bestaande uit 11 doppen 1/4" 6-kant gaande van 4 tot 13mm, 1 mini-handratel 1/4", 1 verlengstuk L.100mm, 1 bitshouder en 10 bitsen. Geleverd in een kunststof doos met klikslot.

Order nr.	132100108		
Orig. nr.	M1424		
Aantal stuks	24		
Bitsen plat	mm	4 - 5,5 - 6,5	
Bitsen PH	1 - 2		
Bitsen TX	10 - 15 - 20		
Doppen 1/4"	mm	4 - 5 - 5,5 - 6 - 7 - 8 - 9 - 10 - 11 - 12 - 13	
Bitsen PZ	1 - 2		
Prijs	€	23,50	

TENGOOLS



24-delige Mini doppenset 1/4". Bestaande uit 11 doppen 1/4" 6-kant gaande van 4 tot 13mm, 1 mini-handratel 1/4", 1 verlengstuk L.75mm, 1 bitshouder en 10 bitsen. Geleverd in een kunststof doos met klikslot.

Order nr.	167920107		
Orig. nr.	T1424		
Aantal stuks	24		
Bitsen plat	mm	4 - 5,5	
Bitsen PH	1 - 2		
Bitsen Hex	3 - 5 - 6		
Bitsen TX	10 - 15 - 20		
Doppen 1/4"	mm	4 - 5 - 5,5 - 6 - 7 - 8 - 9 - 10 - 11 - 12 - 13	
Prijs	€	25,90	

TENGOOLS



NEW

24-delige toolset met 1/4" aansluiting, bevat 10 gewone doppen, 3" verlengstuk, 72 tanden flexibele ratel, koppeling adapter, universele verbinding en 10 bitsen.

Order nr.	186901005		
Orig. nr.	T1424S		
Aantal stuks	24		
Doppen 1/4" 6-kant	mm	4,5 - 5,5 - 6 - 7 - 8 - 10 - 11 - 12 - 13	
Accessoires 1/4"	72 tanden flexibele ratel, adapter, verlengstuk 75 mm		
Bitsen lengte 25mm - 1/4"	mm	plat 3, 4, 5, 5,5 mm TX10, TX15, TX20, TX25, Hex TX27, TX30, TX40 hex 3, 4, 5, 6 mm	
Prijs	€	38,50	

TENGOOLS



36-delige doppenset 1/4" 6-kant bestaande uit 10 korte en 6 lange doppen 1/4" gaande van 4 tot 13mm, 1 ratel 1/4", 1 elleboogstuk, 2 verlengstukken L.50mm en L.100mm, 3 hex-sleutels 1,5 - 2,5mm, 1 bitshouder, 1 adaptor 3/8F:1/4M en 11 bitsen. Geleverd in een kunststof doos met klikslot.

Order nr.	167290105	
Orig. nr.	T1436	
Aantal stuks	36	
Bitsen plat	mm	4 - 5,5
Bitsen PH	1 - 2	
Bitsen Hex	5 - 6	
Bitsen TX	10 - 15 - 20	
Bitsen PZ	1 - 2	
Doppen 1/4" 6-kant	mm	4 - 5 - 5,5 - 6 - 7 - 8 - 10 - 11 - 12 - 13
Doppen 1/4" 6-kant lang	mm	6 - 7 - 8 - 10 - 12 - 13
Sleutels Hex	mm	1,5 - 2 - 2,5
Prijs	€	35,50

TENGOOLS



AF / INCH

35-delige doppenset 1/4" bestaande uit 9 korte en 6 lange AF doppen 1/4" 6-kant gaande van 3/16" to 1/2", 1 ratel 1/4" FRP1400, 1 elleboogstuk, 2 verlengstukken L. 50mm en L. 100mm, 1 T-hendel 1/4", 3 hex-sleutels 1,5-2,5mm, 1 bitshouder en 11 bitsen. Geleverd in een kunststof doos met klikslot.

Order nr.	172470205	
Orig. nr.	T1435AF	
Aantal stuks	35	
Bitsen plat	mm	4 - 5,5
Bitsen PH	1 - 2	
Doppen 1/4"	mm	3/16-7/32-1/4-9/32-5/16-11/32-3/8-7/16-1/2
Bitsen PZ	1 - 2	
Bitsen Hex	mm	5 - 6
Doppen 1/4" lang	mm	3/16-1/4-5/16-3/8-7/16-1/2
Bitsen FX	10 - 15 - 20	
Prijs	€	39,90

TENGOOLS



AF / INCH

60-delige AF en mm doppenset 1/4" 6-kant bestaande uit 21 korte doppen 1/4" gaande van 4 tot 13mm en van 3/16" tot 1/2", 11 lange doppen 1/4" gaande van 6 tot 13mm en van 1/4" tot 1/2", 18 dopbitsen 1/4", 1 ratel 1/4", 1 elleboogstuk, 2 verlengstukken 50x100mm, 1 schroevendraaier met 1/4" en een adaptor 3/8"F-1/4"M en een T-bar. Geleverd in een kunststof doos met dubbel klikslot.

Order nr.	167260108	
Orig. nr.	T1460	
Aantal stuks	60	
Bitsen plat	mm	4 - 5,5
Bitsen PH	1 - 2	
Bitsen TX	10 - 15 - 20	
Bitsen PZ	1 - 2	
Bitsen Hex	mm	5 - 6
Doppen 1/4" 6-kant lang	mm	6 - 7 - 8 - 10 - 12 - 13
Doppen 1/4" 6-kant	mm	4 - 4,5 - 5 - 5,5 - 6 - 7 - 8 - 9 - 10 - 11 - 12 - 13
Doppen 1/4" 6-kant	inch	3/16 - 7/32 - 1/4 - 9/32 - 5/16 - 11/32 - 3/8 - 7/16 - 1/2
Doppen 1/4" 6-kant lang	inch	1/4 - 5/16 - 3/8 - 7/16 - 1/2
Dopbitsen 1/4" plat	mm	4 - 5,5 - 7
Dopbitsen 1/4" TX	10 - 15 - 20 - 25 - 27	
Dopbitsen 1/4" PH	1 - 2	
Prijs	€	79,50

TENGOOLS



1/4" doppenset - 13 delig. Met universele Teng Tools ratel met 45-tands aandrijfmechanisme, in gepatenteerde vezelversterkte uitvoering. Ratel en doppen in handige pocket model doppendoos.

Order nr.	186110102	
Orig. nr.	M1413N1	
Aantal stuks	13	
Doppen 6-kant	mm	4,5, 5,5, 6, 7, 8, 9, 10, 11, 12, 13
Verlengstuk 1/4"	mm	50
Ratel 45 tanden	1/4"	
Prijs	€	26,90

Doppensets 3/8"

TENGOOLS



34-delige doppenset 3/8" 6-kant bestaande uit 9 korte doppen 3/8" gaande van 8 tot 19mm, 1 adaptor 1/2"F-3/8"M, 2 verlengstukken 75x150mm, 1 ratel en 20 bitsen. Geleverd in een kunststof koffer met dubbel klikslot.

Order nr.	167310101		
Orig. nr.	T3834		
Aantal stuks	34		
Doppen 3/8" 6-kant	mm	8 · 10 · 11 · 12 · 13 · 14 · 15 · 17 · 19	
Bitsen plat	mm	3 · 4 · 5,5	
Bitsen TX		10 · 15 · 20 · 25 · 27 · 30 · 40	
Bitsen PH		1 · 2 · 3	
Bitsen PZ		1 · 2 · 3	
Bitsen Hex	mm	3 · 4 · 5 · 6	
Prijs	€	38,50	

TENGOOLS



39-delige doppenset 3/8" bestaande uit 14 korte en 6 lange doppen 3/8" gaande van 8 tot 21mm, 2 bougie doppen, 1 ratel 3/8" FRP3800, 1 adaptor 3/8"F-1/2"M, 1 verlengstuk L.150mm, 1 verlengstuk met bolkop L.75mm, 1 elleboogstuk en 11 bitsen. Geleverd in een kunststof koffer met dubbel klikslot.

Order nr.	167930106		
Orig. nr.	T3839		
Aantal stuks	39		
Doppen 3/8" 6-kant	mm	8 · 9 · 10 · 11 · 12 · 13 · 14 · 15 · 16 · 17 · 18 · 19 · 20 · 22	
Bitsen plat	mm	0,8x4 · 1,2x5,5	
Bitsen TX		10 · 15 · 20	
Bitsen PH		1 · 2	
Bitsen PZ		1 · 2	
Bitsen Hex	mm	5 · 6	
Bougie doppen 3/8" 6-kant	mm	16(5/8") · 21(13/16")	
Doppen 3/8" 6-kant lang	mm	8 · 10 · 12 · 13 · 17 · 19	
Prijs	€	64,90	

TENGOOLS



39-delige doppenset 3/8" 6-kant bestaande uit 14 korte doppen 3/8" gaande van 8 tot 22mm, 9 steekringsleutels gaande van 8 tot 19mm, 1 ratel 3/8", 1 adaptor 1/2"F-3/8"M, 1 verlengstuk L.150mm, 1 bitshouder, 1 elleboogstuk en 11 bitsen. Geleverd in een kunststof koffer met dubbel klikslot.

Order nr.	167280106		
Orig. nr.	T3840		
Aantal stuks	39		
Steekringsleutels	mm	8 · 10 · 11 · 12 · 13 · 14 · 15 · 17 · 19	
Doppen 3/8" 6-kant	mm	8 · 9 · 10 · 11 · 12 · 13 · 14 · 15 · 16 · 17 · 18 · 19 · 21 · 22	
Bitsen plat	mm	0,8x4mm · 1,2x5,5	
Bitsen TX		10 · 15 · 20	
Bitsen PH		1 · 2	
Bitsen PZ		1 · 2	
Bitsen Hex	mm	5 · 6	
Prijs	€	89,50	

TENGOOLS



67-delige combinatieset 3/8" 6-kant. Bestaande uit 14 korte doppen 3/8" gaande van 8 tot 19mm, 10 steekringsleutels gaande van 8 tot 19mm, 6 schroevendraaiers plat en PH, 4 tangen, 1 ratel 3/8", 2 verlengstukken L.75 en L.150mm, 1 adaptor 1/2"F-3/8"M, 1 elleboogstuk en 26 bitsen. Geleverd in een kunststof koffer met dubbel klikslot.

Order nr.	167200104		
Orig. nr.	T3867		
Aantal stuks	67		
Steekringsleutels	mm	8 · 10 · 11 · 12 · 13 · 14 · 15 · 16 · 17 · 18 · 19	
Doppen 3/8" 6-kant	mm	8 · 9 · 10 · 11 · 12 · 13 · 14 · 15 · 16 · 17 · 18 · 19 · 20 · 22	
Bitsen plat	mm	4 · 5 · 7	
Bitsen TX		8 · 10 · 15 · 20 · 25 · 27 · 30 · 40 · 45 · 50	
Bitsen PH		0 · 1 · 2 · 3	
Bitsen PZ		1 · 2 · 3	
Bitsen Hex	mm	3 · 4 · 5 · 6 · 8 · 10	
Lange bektang	mm	200	
Zijkniptang	mm	150	
Combinatie tangen	mm	175	
Waterpomptangen	mm	250	
Schroevendraaiers Plat	mm	3 · 5 · 5 · 6	
Schroevendraaiers PH	mm	0 · 1 · 2	
Bektang	mm	200	
Prijs	€	176,00	

TENGOOLS



48-delige combinatieset 3/8" 6-kant bestaande uit 14 korte doppen 3/8" mm en AF, 2 bougiedoppen 16 en 21mm, 14 steekringsleutels gaande van 8 tot 19mm, 6 schroevendraaiers plat en PH, 5 tangen, 1 schroefsleutel, 1 ratel 3/8", 2 verlengstukken L.75 en L.150mm, 1 adaptor 1/2"F-3/8"M en 1 elleboogstuk. Geleverd in een kunststof koffer met dubbel klikslot.

Order nr.	167210103	
Orig. nr.	T3848	
Aantal stuks	48	
Steekringsleutels	mm	8 · 10 · 12 · 13 · 14 · 15 · 16 · 17 · 18 · 19
Lange bektang	mm	200
Zijkniptang	mm	150
Griplang	mm	175
Combinatie tangen	mm	175
Waterpomptangen	mm	250
Schroevendraaiers Plat	mm	0.5x3.0 · 1.0x5.5 · 1.2x6.5
Schroevendraaiers PH		0 · 1 · 2
Doppen 3/8" 6-kant lang	mm	8 · 10 · 12 · 13 · 14 · 15 · 16 · 17 · 18 · 19
Doppen 3/8" 6-kant	inch	7/16 · 1/2 · 9/16 · 11/16
Bougiedoppen	mm	16 · 21
Steekringsleutels	inch	7/16 · 1/2 · 9/16 · 11/16
Schroefsleutel	mm	200
Prijs	€	206,00

TENGOOLS



AF / INCH

35-delige doppen set 3/8" bestaande uit 10 korte doppen gaande van 5/16" tot 7/8", 6 lange doppen gaande van 3/8" tot 3/4", 2 bougiedoppen, 1 ratel 3/8", 2 verlengstukken 100x150mm, 1 elleboogstuk, 1 adaptor 1/2x3/8 en 11 bitsen. In een kunststof koffer met dubbel klikslot.

Order nr.	172470304	
Orig. nr.	T3835AF	
Aantal stuks	35	
Bitsen plat	mm	0,8x4 · 1,2x5,5
Bitsen TX		10 · 15 · 20
Bitsen PH		1 · 2
Bitsen PZ		1 · 2
Bitsen Hex	mm	5 · 6
Bougiedoppen 3/8" 6-kant	mm	16 · 21
Doppen 3/8"	inch	5/16 · 3/8 · 7/16 · 1/2 · 9/16 · 5/8 · 11/16 · 3/4 · 11/16 · 7/8
Doppen 3/8" lang	inch	3/8 · 7/16 · 1/2 · 9/16 · 11/16 · 3/4
Prijs	€	49,00

TENGOOLS



79-delige serviceset bestaande uit 12 doppen 3/8" 6-kant gaande van 8 tot 22mm, 1 roestvrije 3/8" ratel, 1 adaptator 1/2"F-3/8"M, 4 schroevendraaiers, rolmeter 5m, klauwhamer, 3 tangen, 1 magnetische bitsschroevendraaier, zaklamp, breekmes, telescopische pick-up magneet zaagbeugel, allensleutel set, pin en haken set. Geleverd in een kunststof doos met klikslot. In RVS.

Order nr.	173360108	
Orig. nr.	TM079	
Aantal stuks	79	
Steekringsleutels	mm	6-7-8-10-11
Doppen 3/8" 6-kant	mm	8-10-11-12-13-14-15-17-19-20-21-22
Bitsen plat	mm	4 · 5 · 5 · 6
Bitsen TX		10 · 15 · 20 · 25 · 30 · 40
Bitsen PH		1 · 2 · 3
Bitsen PZ		1 · 2 · 3
Bitsen Rob		1 · 2 · 3
Bitsen Hex	mm	4 · 5 · 6
Bitsen GR		2 (2x)
Allensleutels	mm	1,5 · 2,5 · 3 · 4 · 5 · 6
Schroefsleutel	mm	200
Lange bektang	mm	150
Zijkniptang	mm	150
Combinatie tangen	mm	175
Waterpomptangen	mm	175
Schroevendraaiers Plat	mm	3 · 5,3
Schroevendraaiers PH		1 · 2
Bitsen TPX		20 · 25 · 30
Prijs	€	234,00

TENGOOLS



3/8" doppenzet - 12 delig. Met universele Teng Tools ratel met 45-tands aandrijfmechanisme, in gepatenteerde vezelversterkte uitvoering. Ratel en doppen in handige pocket model doppendoos.

Order nr.	185990108
Orig. nr.	M3812N1
Aantal stuks	12
Doppen 6-kant	8, 10, 11, 12, 13, 14, 15, 16, 17, 19
Verlengstuk 3/8"	mm 75
Ratel 45 tanden	3/8"
Prijs	€ 29,90

TENGOOLS



34-delige toolset met 3/8" aansluiting, bevat 72 tanden flexibele ratel, 9 gewone doppen, 3" en 6" verlengstukken, universele verbinding en 20 bitsen.

Order nr.	186901104
Orig. nr.	T3834S
Aantal stuks	34
Doppen 3/8" 6-kant	mm 8, 10, 11, 12, 13, 14, 15, 17, 19 3mm plat, 4mm plat, 5.5mm plat TX10, TX15, TX20, TX25, TX27, TX30, TX40
Bitsen lengte 25mm - 1/4" Hex	mm TX40 3mm hex, 4mm hex, 5mm hex, 6mm hex PH1, PH2, PH3, PZ1, PZ2, PZ3
Prijs	€ 51,90

Doppensets 1/2"

TENGOOLS



21-delige doppenzet 1/2" bestaande uit 15 korte AF-doppen 1/2" gaande van 3/8" tot 1 1/4", 1 ratel 1/2" 1200FRP, 2 verlengstukken L.65mm en L.150mm, 1 elleboogstuk en 1 adaptor 3/8"F-1/2"M. Geleverd in een kunststof koffer met dubbel klikslot.

Order nr.	172470106
Orig. nr.	T1220AF
Aantal stuks	21
Type dop	12-kant
Doppen 1/2"	inch 3/8 - 7/16 - 1/2 - 9/16 - 5/8 - 11/16 - 3/4 - 13/16 - 7/8 - 15/16 - 1 - 11/16 - 11/8 - 1 3/16 - 1 1/4
Prijs	€ 79,90

TENGOOLS



21-delige doppenzet 1/2" bestaande uit 16 korte doppen 1/2" gaande van 10 tot 32mm, 1 ratel 1/2", 2 verlengstukken L.65 en L.150mm, 1 elleboogstuk en 1 adaptor 1/2"F-3/8"M. Geleverd in een kunststof koffer met dubbel klikslot.

Order nr.	167240100	167240209
Orig. nr.	T1221	T1221-6
Aantal stuks	21	21
Type dop	12-kant	6-kant
Doppen 1/2"	mm 10 - 11 - 12 - 13 - 14 - 15 - 16 - 17 - 18 - 19 - 21 - 22 - 24 - 27 - 30 - 32	10 - 11 - 12 - 13 - 14 - 15 - 16 - 17 - 18 - 19 - 21 - 22 - 24 - 27 - 30 - 32
Prijs	€ 79,90	79,90

TENGTOOLS



34-delige doppenset 1/2" bestaande uit 16 korte doppen 1/2" en 8 lange doppen 1/2" gaande van 11 tot 24mm, 1 ratel 1/2" 1200FRP, 2 bougiedoppen 1/2" van 16 en 21mm, 3 hexsleutels 1,5 - 2 - 2,5mm, 2 verlengstukken L.125 en L.250mm, 1 adaptor 3/8"F-1/2"M en 1 elleboogstuk. Geleverd in een kunststof koffer met dubbel klikslot.

Order nr.	174570101	T
Orig. nr.	T1234	
Aantal stuks	34	
Doppen 1/2" 6-kant	mm	10 - 11 - 12 - 13 - 14 - 15 - 16 - 17 - 18 - 19 - 20 - 21 - 22 - 23 - 24 - 27
Doppen 1/2" 6-kant lang	mm	13 - 14 - 15 - 16 - 17 - 18 - 19 - 24
Bougiedoppen 1/2"	mm	16 - 21
Prijs	€	127,00

TENGTOOLS



68-delige doppenset 1/2" bestaande uit 16 korte doppen 1/2" 12-kant gaande van 10 tot 32mm, 1 adaptor 3/8"F-1/2"M, 1 magnetische bitshouder, 2 verlengstukken 65x150mm, 1 ratel, 1 T-hendel, 10 steekringsleutels gaande van 8 tot 19 mm, 6 schroevendraaiers, 4 tangen en 26 bitsen. Geleverd in een kunststof koffer met dubbel klikslot.

Order nr.	167580109	T
Orig. nr.	T1268	
Aantal stuks	68	
Doppen 1/2" 12-kant	mm	10 - 11 - 12 - 13 - 14 - 15 - 16 - 17 - 18 - 19 - 21 - 22 - 24 - 27 - 30 - 32
Schroevendraaiers Plat	mm	3 - 5,5 - 6,5
Schroevendraaiers PH		0 - 1 - 2 - 3
Zijkniptang	mm	150
Combinatie tangen	mm	175
Lange bektang	mm	200
Waterpomptangen	mm	250
Steekringsleutels	mm	8 - 10 - 11 - 12 - 13 - 14 - 15 - 16 - 17 - 19
Bitsen plat	mm	4 - 5 - 5 - 7
Bitsen TX	mm	8 - 10 - 15 - 20 - 25 - 27 - 30 - 40 - 45 - 50
Bitsen PH		0 - 1 - 2 - 3
Bitsen PZ		0 - 1 - 2 - 3
Bitsen Hex	mm	3 - 4 - 5 - 6 - 8 - 10
Prijs	€	214,00

TENGTOOLS



72-delige doppenset 1/4" en 1/2" bestaande uit 10 korte doppen 1/4" en 16 korte doppen 1/2" 12-kant gaande van 4 tot 27mm, 2 ratels 1/4" 1400FRP en 3/8" 3800FRP, 1 verlengstuk 1/4" L.100mm, 1 bi-flex sleutel 1/4" hex x 1/4" drive, 2 verlengstukken 1/2" L.125mm en L.250mm, 1 elleboogstuk 1/2", 1 adaptor 3/8"F-1/2"M, 1 flex-kopstuk 1/2" en 33 bitsen. Geleverd in een kunststof koffer met dubbel klikslot.

Order nr.	174580100	T
Orig. nr.	T1272	
Aantal stuks	72	
Bitsen plat	mm	4 - 5,5 - 7
Bitsen TX	mm	8 - 10 - 15 - 20 - 25 - 27 - 30 - 40 - 45 - 50
Bitsen PH		0,8x4 - 0 - 1 - 2 - 3
Bitsen PZ		1 - 2 - 3
Doppen 1/4" 6-kant	mm	4 - 5 - 5,5 - 6 - 7 - 8 - 10 - 11 - 12 - 13 - 10 - 11 - 12 - 13 - 14 - 15 - 16 - 17 - 18 - 19 - 20 - 21 - 22 - 23 - 24 - 27
Doppen 1/2" 12-kant	mm	18 - 19 - 20 - 21 - 22 - 23 - 24 - 27
Bitsen Hex	inch	1/8 - 9/64 - 5/32 - 3/16 - 7/32 - 1/4 - 3/8
Bitsen Ribe		5 - 6
Sleutels Hex	mm	1,5 - 2 - 2,5
Prijs	€	131,00



TENGOOLS



106-delige combi-superset. Bestaande uit o.a. doppen 1/4", 3/8" en 1/2" gaande van 4 tot 32mm en 3/16" tot 1 3/16", bitsen, ratels 1/4", 3/8", elleboogstuk 1/4" en 1/8", verlengstukken, adaptors, 1 bi-flex sleutel 1/4 flex x 1/4 drive, bitshouder 1/4, 1 flex kopstuk 1/2. Geleverd in een kunststof koffer.

Order nr.	167220102
Orig. nr.	TM106
Aantal stuks	106
Steekringsleutels	mm 8 - 9 - 10 - 11 - 12 - 13 - 14 - 15 - 16 - 17 - 18 - 19
Doppen 3/8" 6-kant	mm 8 - 9 - 10 - 11 - 12 - 13 - 14 - 15 - 16 - 17 - 18 - 19 - 21 - 22
Verlengstukken	inch x mm 1/4x50 - 1/4x75 - 3/8x75 - 3/8x150 - 1/2x63 - 1/2x250
Bougiedoppen 3/8"	inch 16 - 21
Doppen 1/4" 6-kant	mm 4 - 5 - 5,5 - 6 - 7 - 8 - 10 - 11 - 12 - 13
Doppen 1/4" 6-kant lang	mm 6 - 7 - 8 - 10 - 12 - 13
Doppen 1/2" 12-kant	mm 19 - 24 - 27 - 30 - 32
Bi-flex sleutels	mm 8x9 - 10x11 - 12x13 - 14x15
Schroefleutels	inch 10
Bitsen lengte 25mm - 1/4" plat	mm 4 - 5 - 5 - 7
Bitsen lengte 25mm - 1/4" TX	mm 8 - 10 - 15 - 20 - 25 - 27 - 30 - 40
Bitsen lengte 25mm - 1/4" PH	mm 0 - 1 - 2 - 3
Bitsen lengte 25mm - 1/4" TPX	mm 10 - 15 - 20 - 25 - 27 - 30 - 40
Bitsen lengte 25mm - 1/4" Hex	mm 3 - 4 - 5 - 6 - 8 - 10
Bitsen lengte 25mm - 1/4" Ribe	mm 5 - 6
Adaptors M/F	inch 1/23/8 - 1/4-3/8 - 3/8-1/2
Prijs	€ 252,00

TENGOOLS



AF / INCH

111-delige combi-superset. Bestaande uit o.a. mm en AF doppen 1/4", 3/8", 1/2" gaande van 4 tot 32mm en 3/16" tot 1 3/16", bitsen, ratels 1/4", 3/8" en 1/2", dopbitsschroevendraaier 1/4" en 3/8", T-baar en diverse accessoires. Geleverd in een kunststof koffer.

Order nr.	167230101
Orig. nr.	TM111
Aantal stuks	111
Doppen 1/4" 6-kant	mm 4 - 5 - 6 - 7 - 8 - 10 - 12
Doppen 1/4" 6-kant	inch 3/16 - 7/32 - 1/4 - 9/32 - 3/8 - 7/16
Doppen 3/8" 6-kant	mm 8 - 9 - 10 - 12 - 13 - 14 - 15 - 16 - 17
Doppen 3/8" 6-kant	inch 3/8 - 7/16 - 1/2 - 9/16 - 11/16 - 3/4 - 13/16 - 7/8
Doppen 3/8" 6-kant lang	mm 8 - 9 - 10 - 12 - 13 - 14 - 15 - 16 - 17
Doppen 3/8" 6-kant lang	inch 3/8 - 7/16 - 1/2 - 9/16 - 11/16 - 3/4 - 13/16 - 7/8
Doppen 1/2" 6-kant	mm 17 - 24 - 27 - 32
Doppen 1/2" 6-kant	inch 11/16 - 3/4 - 13/16 - 7/8 - 1 - 1 3/16
Bougiedoppen 3/8" 6-kant	mm 16 - 21
Verlengstukken	inch x mm 1/4x150(flex.) - 1/4x50 - 1/4x100 - 3/8x75 - 3/8x150 - 1/2x63 - 1/2x250
Adaptor M/F	inch 3/8-1/4 - 1/2-3/8 - 3/8-1/2
Bitsen lengte 25mm - 5/16" TX	mm 45 - 50
Bitsen plat	mm 4 - 5 - 5 - 7
Bitsen TX	mm 10 - 15 - 20 - 25 - 30 - 40
Bitsen PH	mm 1 - 2 - 3
Bitsen PZ	mm 1 - 2 - 3
Bitsen Hex (1)	mm 3 - 4 - 5 - 6 - 7 - 10
Bitsen Hex (2)	inch 1/8 - 9/64 - 5/32 - 3/16 - 1/4 - 5/16
Prijs	€ 227,00

TENGOOLS



30-delige doppenset 1/2" MM en AF 12-kant, 1 verlengstuk L.125mm, 1 adaptor 3/8"F-1/2"M en 26 doppen 1/2" gemengd AF en MM, 1 elleboogstuk. Geleverd in een kunststof koffer met dubbel klikslot.

Order nr.	178020103
Orig. nr.	T1230
Aantal stuks	30
Doppen 1/2"	mm 10 · 12 · 13 · 14 · 15 · 16 · 17 · 18 · 19 · 21 · 23 · 24 · 27 · 30 · 32
Adaptor M/F	inch 1/2 · 3/8
Verlengstuk 1/2"	mm 125
Doppen 1/2"	inch 3/8 · 7/16 · 1/2 · 9/16 · 5/8 · 3/4 · 13/16 · 15/16 · 1 1/8 · 1 1/4
Prijs	€ 96,90

TENGOOLS



12-delige doppenset 1/2". 12-kant. Met universele Teng Tools ratel met 45-tands aandrijfmechanisme, in gepatenteerde vezelversterkte uitvoering. Ratel en doppen in handige pocket model doppendoos.

Order nr.	186100103
Orig. nr.	M1212N1
Aantal stuks	12
Doppen	10, 12, 13, 14, 15, 17, 18, 19, 24
Verlengstuk 1/2"	mm 125
Ratel 45 tanden	1/2"
Prijs	€ 44,90

Doppensets 3/4"

TENGOOLS



18-delige doppenset 3/4" bestaande uit 14 doppen 3/4" 6-kant gaande van 19 tot 50mm, 1 ratel 3/4" 40 tanden L.500mm, 1 T-hendel L.450mm en 2 verlengstukken L.200 en L.400mm.

Verpakt in een kunststof koffer.

Order nr.	167380104
Orig. nr.	T3418-6
Aantal stuks	18
Doppen 3/4" 6-kant	mm 19 · 21 · 22 · 24 · 27 · 30 · 32 · 33 · 34 · 36 · 38 · 41 · 46 · 50
Verlengstukken	mm 200 · 400
Prijs	€ 269,00

TENGOOLS



22-delige doppenset 3/4" mm en AF bestaande uit 8 doppen 3/4" 6-kant mm en 9 doppen 3/4" 12-kant mm/AF gaande van 19 tot 2" (50mm), 1 ratel 3/4" L.500mm, 1 T-hendel L.450mm en 3 verlengstukken L.100mm, L.200 en L.400mm met safety lock. Geleverd in een kunststof koffer met dubbel klikslot.

Order nr.	167370105
Orig. nr.	T3422S
Aantal stuks	22
Doppen 3/4" 6-kant	mm 19 · 21 · 24 · 27 · 32 · 34 · 36 · 50
Verlengstukken	mm 100 · 200 · 400
Doppen 3/4" 12-kant	inch 7/8 · 1 · 1 1/8 · 1 3/16 · 1 5/16 · 1 1/2 · 1 5/8 · 1 13/16 · 2
Prijs	€ 278,00

Doppensets 1"

TENGOOLS



15-delige doppenset 1" bestaande uit 10 doppen 1" 12-kant gaande van 36 tot 80mm, 1 ratel 1", 1 T-hendel L.560mm en 2 verlengstukken L.200 en L.400mm. Verpakt in een stevige metalen koffer.

Order nr.	73530107		
Orig. nr.	M1115MM		
Aantal stuks	15		
Doppen 1"	mm	36 · 41 · 46 · 50 · 55 · 60 · 65 · 70 · 75 · 80	
Verlengstukken	mm	200 · 400	
Prijs	€	379,00	

Doppensets RVS

TENGOOLS



RVS

16-delige doppenset 3/8" bestaande uit 12 doppen 3/8" 6-kant gaande van 8 tot 19mm, 1 roestvrije 3/8" ratel 36 tanden, verlengstuk 75x125mm en 1 adaptor 3/8"F-1/2"M. Geleverd in een kunststof doos met klikslot. In RVS.

Order nr.	167520105		
Orig. nr.	TS3816		
Doppen 3/8" 6-kant	mm	8 · 9 · 10 · 11 · 12 · 13 · 14 · 15 · 16 · 17 · 18 · 19	
Aantal stuks	16		
Prijs	€	299,00	

TENGOOLS



RVS

18-delige doppenset 1/2" bestaande uit 12 doppen 1/2" 6-kant gaande van 10 tot 24mm, 3 lange doppen 1/2" gaande van 17 tot 21mm, 1 ratel RVS 1/2" 36 tanden, L.125mm verlengstuk en 1 adaptor 1/2"F-3/8"M. Geleverd in een kunststof doos met klikslot.

Order nr.	167510106		
Orig. nr.	TS1218		
Aantal stuks	18		
Doppen 1/2" 6-kant	mm	10 · 11 · 12 · 13 · 14 · 15 · 16 · 17 · 18 · 19 · 21 · 24	
Doppen 3/8" 6-kant lang	mm	17 · 19 · 21	
Prijs	€	386,00	



Doppen op rail 1/4"

TENGOOLS



Set van 12 doppen 6-kant 1/4" gaande van 4 tot 13mm. Geleverd op een metalen rail met dopclips.

Order nr.	117070102
Orig. nr.	M1412
Doppen 1/4"	mm 4 · 4,5 · 5 · 5,5 · 6 · 7 · 8 · 9 · 10 · 11 · 12 · 13
Prijs	€ 21,90

TENGOOLS



Set van 9 lange doppen 1/4" 6 kant L.50mm gaande van 4 tot 13mm. Geleverd op een metalen rail met dopclips.

Order nr.	73090102
Orig. nr.	M1407
Doppen 1/4"	mm 4 · 5 · 6 · 7 · 8 · 9 · 10 · 12 · 13
Prijs	€ 26,50

TENGOOLS



Set van 7 dopbitsen 1/4" TX gaande van TX10 tot TX40. Geleverd op een metalen rail met dopclips.

Order nr.	117090209
Orig. nr.	M1408TX
Doppen 1/4"	TX 10 · 15 · 20 · 25 · 27 · 30 · 40
Prijs	€ 22,90

Doppen op rail 3/8"

TENGOOLS



Set van 16 korte 6-kant doppen 3/8" gaande van 7 tot 22mm. Geleverd op een metalen rail met dopclips.

Order nr.	116660101
Orig. nr.	M3816
Doppen 3/8"	mm 7 · 8 · 9 · 10 · 11 · 12 · 13 · 14 · 15 · 16 · 17 · 18 · 19 · 20 · 21 · 22
Prijs	€ 35,90

TENGOOLS

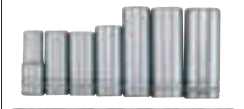

Set van 7 lange doppen 3/8" gaande van 10 tot 19mm. 6-kant opening. Buitengrip 6-kant 24mm. Geleverd op een metalen rail met dopclips.

Order nr.	73160103
Orig. nr.	M3807
Doppen 3/8" 6-kant	mm 10 · 12 · 13 · 14 · 15 · 17 · 19
Lengte	mm 45 · 65
Prijs	€ 29,90

TENGOOLS



Set van 9 dopbitsen 3/8" Hex gaande van 3 tot 12mm. Ofwel een set van 8 dopbitsen 3/8" AF Hex gaande van 3/32" tot 3/8". Geleverd op een metalen rail met dopclips.

Order nr.	68830108	68830207
Orig. nr.	M3812	M3811
Dopbitsen 3/8" (1)	mm 3 · 4 · 5 · 5,5 · 6 · 7 · 8 · 10 · 12	
Dopbitsen 3/8" (2)	inch	3/32 · 1/8 · 5/32 · 3/16 · 7/16 · 1/4 · 5/16 · 3/8
Prijs	€ 40,50	40,50

TENGOOLS



Set van 9 dopbitsen 3/8" TX (M3813TX) of TPX (M3813TPX) gaande van TX10 tot TX50. Geleverd op een metalen rail met dopclips.

Order nr.	68840107	102180106
Orig. nr.	M3813TPX	M3813TX
Dopbitsen 3/8" TPX	10 · 15 · 20 · 25 · 27 · 30 · 40 · 45 · 50	
Dopbitsen 3/8" TX		10 · 15 · 20 · 25 · 27 · 30 · 40 · 45 · 50
Prijs	€ 41,90	29,90

TENGOOLS



Set van 5 doppen 1/4" en 5 doppen 3/8" E-TX gaande van TX-E 4 tot 18. Geleverd op een metalen rail met dopclips.

Order nr.	04850103		
Orig. nr.	M3814		
Doppen 1/4"	TX-E	4 - 5 - 6 - 7 - 8	
Doppen 3/8"	TX-E	10 - 12 - 14 - 16 - 18	
Prijs	€	29,90	

TENGOOLS



Doppenset 3/8" 14dlg gaande van 8 tot 19mm. Roestvrijstaal. Geleverd op een metalen rail met dopclips.

RVS

Order nr.	162560106		
Orig. nr.	MS3814		
Verlengstukken	mm	75 - 125	
Maat	mm	8 - 9 - 10 - 11 - 12 - 13 - 14 - 15 - 16 - 17 - 18 - 19	
Prijs	€	174,00	

Doppen op rail 1/2"

TENGOOLS



Set van 15 doppen 1/2" 12-kant MM en AF. Geleverd op een metalen rail met dopclips.

Order nr.	28130102	28130201
Orig. nr.	M1215MM	M1215AF
Doppen 1/2"	mm	10 - 12 - 13 - 14 - 15 - 16 - 17 - 18 - 19 - 21 - 22 - 24 - 27 - 30 - 32
Doppen 1/2"	inch	3/8 - 7/16 - 1/2 - 9/16 - 5/8 - 11/16 - 3/4 - 13/16 - 7/8 - 15/16 - 1 - 11/16 - 11/8 - 1 3/16 - 1 1/4
Prijs	€	68,00
		71,90

TENGOOLS



Set van 8 lange doppen 1/2" 12-kant gaande van 13 tot 24mm. Geleverd op een metalen rail met dopclips. L.80mm.

Order nr.	73100109		
Orig. nr.	M1207		
Doppen 1/2" lang	mm	13 - 14 - 15 - 17 - 19 - 21 - 22 - 24	
Prijs	€	35,90	

TENGOOLS



Set van 8 lange doppen 1/2" 6-kant gaande van 13 tot 24mm. Geleverd op een metalen rail met dopclips. L.80mm.

Order nr.	101710101		
Orig. nr.	M12086		
Doppen 1/2" lang	mm	13 - 14 - 15 - 16 - 17 - 18 - 19 - 24	
Prijs	€	35,90	

TENGOOLS



Set van 9 korte doppen 1/2" TX-E gaande van E10 tot E24. Geleverd op een metalen rail met dopclips.

Order nr.	116610104		
Orig. nr.	M1210		
Doppen 1/2"	E	10 - 11 - 12 - 14 - 16 - 18 - 20 - 22 - 24	
Prijs	€	47,90	

TENGOOLS



Set van 9 korte dopbitsen 1/2" Hex gaande van Hex 5 tot 17mm. Geleverd op een metalen rail met dopclips.

Order nr.	19070101		
Orig. nr.	M1212		
Dopbitsen 1/2"	mm	5 - 6 - 7 - 8 - 9 - 10 - 12 - 14 - 17	
Prijs	€	44,90	

TENGOOLS



Set van 6 lange dopbitsen 1/2" Hex gaande van Hex 5 tot 12mm. Geleverd op een metalen rail met dopclips. L.100mm.

Order nr.	118910108 ⓘ		
Orig. nr.	M1211		
Dopbitsen 1/2"	mm	5 - 6 - 7 - 8 - 10 - 12	
Prijs	€	39,50	

TENGOOLS



Set van 9 korte dopbitsen 1/2" TX (M1213TX) en TPX (M1213TPX) gaande TX20 tot TX60. Geleverd op een metalen rail met dopclips.

Order nr.	38190054 ⓘ	38190104 ⓘ
Orig. nr.	M1213TX	M1213TPX
Dopbitsen 1/2" TX	20 - 25 - 27 - 30 - 40 - 45 - 50 - 55 - 60	
Dopbitsen 1/2" TPX		20 - 25 - 27 - 30 - 40 - 45 - 50 - 55 - 60
Prijs	€	49,00

TENGOOLS



Set van 9 lange dopbitsen 1/2" TX gaande TPX20 tot TPX60. Geleverd op een metalen rail met dopclips.

Order nr.	118900109 ⓘ		
Orig. nr.	M1214TX		
Maatsysteem	TX		
Dopbitsen 1/2"	20 - 25 - 27 - 30 - 40 - 45 - 50 - 55 - 60		
Prijs	€	64,50	

TENGOOLS



Set van 12 korte doppen 1/2" kant gaande van 10 tot 24mm. Roesvrijstaal. Geleverd op een metalen rail met dopclips.

Order nr.	162550107 ⓘ		
Orig. nr.	MS1213		
Maat	mm	10 - 11 - 12 - 13 - 14 - 15 - 16 - 17 - 18 - 19 - 21 - 24	
Verlengstuk	mm	75	
Prijs	€	287,00	

Doppensets BTool

B-TOOL



108-delige dop- en dopbitsset 1/4"-1/2" bestaande uit 21 korte en lange doppen 1/4", 24 korte en lange doppen 1/2", 18 dopbitsen 1/4", 16 bitsen 5/16", TX doppen 1/4" en 1/2", ratel 1/2" en 1/4" 48 tanden en accessoires 1/4" en 1/2". Verpakt in een kunststof koffer.

- Aantal stuks 108
- Doppen 1/4" mm 4 - 4,5 - 5 - 5,5 - 6 - 7 - 8 - 9 - 10 - 11 - 12 - 13 - 14
- Doppen 1/4" lang mm 6 - 7 - 8 - 9 - 10 - 11 - 12 - 13
- Doppen 1/2" mm 10 - 11 - 12 - 13 - 14 - 15 - 16 - 17 - 18 - 19 - 20 - 21 - 22 - 24 - 27 - 30 - 32
- Doppen 1/2" lang mm 14 - 15 - 16 - 17 - 19 - 21 - 22
- Dopbitsen 1/4" Hex 3mm - Hex 4mm - Hex 5mm - Hex 6mm - 3-Slo 4mm - 3-Slo 5,5mm - 3-Slo 6,5mm - PH1 - PH2 - PZ1 - PZ2 - TX8 - TX10 - TX15 - TX20 - TX25 - TX27 - TX30
- E-TX doppen 1/4" E4 - E5 - E6 - E7 - E8
- E-TX doppen 1/2" Aantal tanden E10 - E11 - E12 - E14 - E16 - E18 - E20 - E22
- Ratel 1/4" 48 tanden
- Ratel 1/2" 48 tanden
- T-baar 1/4" 1
- Verlengstukken 1/4" mm 50 - 100
- Verlengstukken 1/2" mm 125 - 250
- Kniekoppeling 1/4"
- Allensleutels mm 1,27 - 1,5 - 2 - 2,5
- Bitsen 5/16" Hex 8mm - Hex 10mm - Hex 12mm - Hex 14mm - Plat 8mm - Plat 10mm - Plat 12mm - PH3 - PH4 - PZ3 - PZ4 - TX40 - TX45 - TX50 - TX55 - T60
- Bitshouder 1/4" mm 60
- Bitshouder met handvat

Order nr.	855006916 ⓘ		
Orig. nr.	BT42108		
Gewicht	kg	6,80	
Afmetingen (l x b x h)	mm	410 x 310 x 395	
Prijs	€	66,90	

Sleutels

Ons assortiment werd gedurende vele jaren ontwikkeld, met gebruik van DIN- en ISO-normen als minimum maatstaf voor kwaliteit- en maattoleranties. Een beleid dat vaak tot beste noteringen in consumenten- en vakbladen heeft geleid. Alle sleutels zijn beschikbaar zowel individueel als ook in complete sets opgeslagen in Teng Tools TC-trays, EVA-trays en/of in hoogwaardige stoffen opbergzakken of op wandrekken.



Steekringsleutels

- Ontworpen en vervaardigd conform DIN3113A, uit hoogwaardig chroom vanadium staal.
- 15° hellingshoek aan de ringkant om het werk te vergemakkelijken op platte oppervlakken.
- Speciale “hip grip” ringkant met hoge grip, om de kracht op de kant en niet op de hoek uit te oefenen. Dit voorkomt dat de bouten beschadigd worden, en maakt het gebruik op eerder beschadigde bouten mogelijk.

Ratel steekringsleutels

- Omkeerbare ratel met hellingshoek 15 graden aan de ringkant om het werk te vergemakkelijken op platte oppervlakken.
- Snel omschakelsysteem voor richtingsverandering met één hand.
- 72 tanden ratel met een increment van slechts 5 graden.

Ratel sleutels met flexibele kop

- 12-kant ratel steekringsleutel met 180 graden flexibele verbinding voor toegang in de meest moeilijk te bereiken plaatsen.
- 72 tanden ratel met een increment van slechts 5 graden.



Sleutels

Steekringsleutels



Steekringsleutel set. Chrome vanadium staal. Identieke maten aan beide uiteinde satijn afwerking. Hellingshoek ringkant 15°. Geleverd in een kartonnen doos.

Order nr.	Orig. nr.	Aantal stuks	Steekringsleutels mm	Prijs €
185860103	6512N	12	8, 9, 10, 11, 12, 13, 14, 15, 16, 17, 18, 19	44,50
185830106	6512	12	8 - 9 - 10 - 11 - 12 - 13 - 14 - 15 - 16 - 17 - 19 - 22	44,50
185830304	6517	17	6 - 7 - 8 - 9 - 10 - 11 - 12 - 13 - 14 - 15 - 16 - 17 - 18 - 19 - 20 - 21 - 22	64,90
185830205	6521	21	6 - 7 - 8 - 9 - 10 - 11 - 12 - 13 - 14 - 15 - 16 - 17 - 18 - 19 - 20 - 21 - 22 - 24 - 27 - 30 - 32	105,00

TENGTOOLS

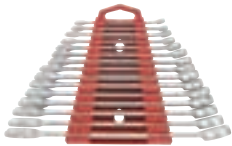

3 sets van steekringsleutels. Alle sets hebben opeenvolgend maten en kunnen gecombineerd worden. Identieke maten aan beide uiteinden. Geleverd op een handige muurhanger. Chrome vanadium. Satijn afwerking. Hellingshoek ringkant 15°.

Order nr.	154910103	154910202	154910301
Orig. nr.	6515MMA	6512MMA	6507JMMMA
Aantal stuks	15	12	7
Steekringsleutels mm	5,5 - 6 - 7 - 8 - 9 - 10 - 11 - 12 - 13 - 14 - 15 - 16 - 17 - 19	20 - 21 - 22 - 23 - 24 - 25 - 26 - 27 - 28 - 29 - 30 - 32	33 - 34 - 36 - 38 - 41 - 46 - 50
Prijs €	59,90	119,00	229,00

TENGTOOLS



Set steekringsleutels gaande van ofwel 1/4" tot 1 3/16", ofwel 1/4" tot 1 5/16" naargelang de set. Geleverd in een kartonnen doos.

Order nr.	703311117	703311120
Orig. nr.	I20331441117	I20331441120
Aantal stuks	17	20
Steekringsleutels mm	1/4 - 5/16 - 3/8 - 7/16 - 1/2 - 9/16 - 19/32 - 5/8 - 11/16 - 3/4 - 25/32 - 13/16 - 7/8 - 15/16 - 1 - 1/16 - 1 3/16	1/4 - 5/16 - 3/8 - 7/16 - 1/2 - 9/16 - 19/32 - 5/8 - 11/16 - 3/4 - 25/32 - 13/16 - 7/8 - 15/16 - 1 - 1/16 - 1 1/8 - 1 3/16 - 1 1/4 - 1 5/16
Steekringsleutels inch		
Prijs €	123,00	159,00

TENGTOOLS



Steekringsleutelsets. Chrome vanadium. Identieke maten aan beide uiteinden. Satijn afwerking. Hellingshoek ringkant 15°. Geleverd in een rolltas.

Order nr.	Orig. nr.	Aantal stuks	Steekringsleutels mm	Steekringsleutels inch	Prijs €
151590304	6515MM	15	5,5 - 6 - 7 - 8 - 9 - 10 - 11 - 12 - 13 - 14 - 15 - 16 - 17 - 18 - 19 - 20 - 21 - 22 - 23 - 24		59,00
167170109	6517MM	17	6 - 7 - 8 - 9 - 10 - 11 - 12 - 13 - 14 - 15 - 16 - 17 - 18 - 19 - 20 - 21 - 22		81,00
151590205	6512MM	12	20 - 21 - 22 - 23 - 24 - 25 - 26 - 27 - 28 - 29 - 30 - 32		118,00
151590106	6507JMM	7	33 - 34 - 36 - 38 - 41 - 46 - 50		249,00
167180108	6526MM	26	6 - 7 - 8 - 9 - 10 - 11 - 12 - 13 - 14 - 15 - 16 - 17 - 18 - 19 - 20 - 21 - 22 - 23 - 24 - 25 - 26 - 27 - 28 - 29 - 30 - 32		167,00
151590403	6507AF	7		13/16 - 7/8 - 15/16 - 1 - 1 1/16 - 1 1/8 - 1 1/4	79,00
151590601	6509AF	9		1/4 - 5/16 - 3/8 - 7/16 - 1/2 - 9/16 - 5/8 - 11/16 - 3/4 - 15/16 - 1 3/8 - 1	41,90
151590502	6507JAF	7		7/16 - 1 1/2 - 1 5/8 - 1 3/4 - 1 7/8	239,00

TENGTOOLS



Set van 12 steekringsleutels gaande van 8 tot 19mm. TC-tray.

Order nr.	27560101
Orig. nr.	TT1236
Aantal stuks	12
Sleutels mm	8 - 9 - 10 - 11 - 12 - 13 - 14 - 15 - 16 - 17 - 18 - 19
Afmetingen (l x b x h) mm	265 x 142 x 50
Prijs €	45,90

TENGTOOLS



Set van 8 steekringsleutels AF gaande van 5/16" tot 3/4". De ringkant heeft een hellingshoek van 15°. Identieke maten aan beide kanten van de sleutel. TC-tray.

Order nr.	58050303
Orig. nr.	TT3592
Aantal stuks	8
Steekringsleutels mm	5/16 - 3/8 - 7/16 - 1/2 - 9/16 - 5/8 - 11/16 - 3/4
Afmetingen (l x b x h) mm	265 x 142 x 50
Prijs €	39,90

TENGOOLS

AF / INCH



Set van 7 steekringsleutels gaande van 20 tot 32mm of van 13/15" tot 1 1/4" voor de AF-set. De ringkant heeft een hellingshoek van 15°. Identieke maten aan beide kanten van de sleutel. TTX-tray.

Order nr.	68910108	68910207
Orig. nr.	TTX2032	TTX2640
Aantal stuks	7	7
Maat	inch	13/16 - 7/8 - 15/16 - 1 - 1 1/16 - 1 1/8 - 1 1/4
Maat	mm	20 - 21 - 22 - 24 - 27 - 30 - 32
Afmetingen (l x b x h)	mm	560 x 110 x 40
Prijs	€	77,90
		79,90

TENGOOLS



Handige stalen ring met clip-opening voor bevestiging van uw steekringsleutels op een ringhanger.

Order nr.	27560200
Orig. nr.	600
Prijs	€
	5,20

TENGOOLS



Steekringsleutel. Uitvoering DIN 3113A - ISO 3319. Vorm ISO 7738. Teng Tools chroom vanadium staal. Matverchromd. Identieke maten aan beide uiteinden. Hellingshoek ringkant 15°. Teng Tools (600...) of Izeltas (IZ...).

Order nr.	Orig. nr.	Maat mm	Maat inch	Lengte mm	Prijs €
72670052	6005055	5,5		95	5,30
72670102	600506	6		100	4,80
72670201	600507	7		110	4,80
72670300	600508	8		120	4,80
72670409	600509	9		130	5,60
72670508	600510	10		140	5,60
72670607	600511	11		150	6,00
72670706	600512	12		160	6,00
72670805	600513	13		170	6,50
72670904	600514	14		180	6,50
72671001	600515	15		190	7,40
72671100	600516	16		200	7,90
72671209	600517	17		210	7,90
72671308	600518	18		220	9,30
72671407	600519	19		230	9,80
72671506	600520	20		240	10,90
72671605	600521	21		250	10,90
72671704	600522	22		260	11,50
72671803	600523	23		270	14,50
72671902	600524	24		280	15,00
72672009	600525	25		290	17,50
72672108	600526	26		300	18,50
72672207	600527	27		310	20,50
72672306	600528	28		320	20,50
72672405	600529	29		330	21,50
72672504	600530	30		340	23,50

Order nr.	Orig. nr.	Maat mm	Maat inch	Lengte mm	Prijs €
72672603	600532	32		360	24,50
72672652	600533	33		380	29,50
72672686	600534	34		380	29,50
72672702	600536	36		410	42,50
72672751	600538	38		430	46,00
72672801	600541	41		460	54,50
72672850	600546	46		500	62,50
72672900	600550	50		540	77,90
72672926	600555	55		560	189,00
72672942	600558	58		600	248,00
72672959	600560	60		600	250,00
72672967	600565	65		680	349,00
72672983	600570	70		680	349,00
72673007	600108		1/4	100	6,00
72673106	600110		5/16	120	6,00
72673205	600112		3/8	140	6,40
72673304	600114		7/16	150	6,70
72673403	600116		1/2	170	7,60
72673502	600118		9/16	180	7,80
703311500	I20331440015		19/32	215	7,00
72673601	600120		5/8	200	8,90
72673700	600122		11/16	210	9,30
72673809	600124		3/4	230	11,50
703312000	I20331440020		25/32	275	11,50
72673825	600126		13/16	250	12,90
72673833	600128		7/8	260	15,50
72673841	600130		15/16	280	16,90
72673858	600132		1	290	19,50
72673874	600136		1 1/8	330	20,90
72673866	600134		1 1/16	310	19,50
72673882	600140		1 1/4	360	24,50
72673908	600142		1 5/16	380	30,00
72674005	600144		1 3/8	380	31,00
72674104	600146		1 7/16	410	41,90
72674203	600148		1 1/2	430	41,90
72674302	600152		1 5/8	460	54,50
72674401	600156		1 3/4	500	72,00
72674500	600160		1 7/8	540	98,50

TENGOOLS



Set van 10 stubby (korte) steekringsleutels gaande van 10 tot 19mm. De ringkant heeft een hellingshoek van 15°. TC-tray.

Order nr.	109470104		
Orig. nr.	TT6010M		
Aantal stuks	10		
Steekringsleutels	mm	10 · 11 · 12 · 13 · 14 · 15 · 16 · 17 · 18 · 19	
Afmetingen (l x b x h)	mm	256 x 142 x 50	
Prijs	€	46,50	

TENGOOLS



Stubby steekringsleutel. Extra-korte uitvoering. Teng Tools chroom vanadium staal. Matverchromd. De ringkant heeft een hellingshoek van 15°. Identieke maten aan beide uiteinden.

Order nr.	Orig. nr.	Maat mm	Lengte mm	Prijs €
116510108	6005M10	10	95	4,55
116510207	6005M11	11	100	4,87
116510306	6005M12	12	105	5,30
116510405	6005M13	13	110	5,50
116510504	6005M14	14	115	5,80
116510603	6005M15	15	120	6,30
116510702	6005M16	16	125	6,70
116510801	6005M17	17	130	7,60
116510900	6005M18	18	135	7,90
116511007	6005M19	19	140	8,90

TENGOOLS



Set van 8/10 ratel-steekringsleutels gaande van 8 tot 19mm/10 tot 19mm. Vervaardigd uit hoogwaardig Teng Tools chroom vanadium staal. Matverchromd. Identieke maten aan beide uiteinden. Ringkant 12-kant met hellingshoek 15° en handige omschakelknop voor het wijzigen van de draairichting. Actiehoek 5°. Geleverd in een roltas.

Order nr.	167150101	186430104
Orig. nr.	6508RMM	6510RMM
Aantal stuks	8	10
Maatsysteem	mm	
Ratel-steekringsleutels	mm	8 · 10 · 11 · 12 · 13 · 14 · 17 · 19
		10, 11, 12, 13, 14, 15, 16, 17, 18, 19
Prijs	€	122,00

TENGOOLS



Set van 8 ratel-steekringsleutels gaande van 8 tot 19mm. Identieke maten aan beide kanten van de sleutel. Model zonder omschakelknop. Platte sleutel. Geleverd in een roltas.

Order nr.	167160100		
Orig. nr.	6508RSM		
Aantal stuks	8		
Maatsysteem	mm		
Ratel-steekringsleutels	mm	8 · 10 · 11 · 12 · 13 · 14 · 17 · 19	
Prijs	€	104,00	

TENGOOLS



11-delige ratel-steekringsleutel set. Vervaardigd uit hoogwaardig chroom vanadium staal. Matverchromd. Identieke maten aan beide uiteinden. Ringkant 12-kant met hellingshoek 15° en handige omschakelknop voor het wijzigen van de draairichting. Actiehoek 5°.

Order nr.	186740106		
Orig. nr.	TT6511R		
Aantal stuks	11		
Maten	mm	8, 9, 10, 11, 12, 13, 14, 15, 16, 17, 19	
Prijs	€	158,00	

TENGOOLS



Set van 8 ratel-steekringsleutels gaande van 8 tot 19mm of van 5/16" tot 3/4" voor de AF-set. Identieke maten aan beide kanten van de sleutel. Ringkant 12-kant met hellingshoek 15° en handige omschakelknop voor het wijzigen van de draairichting. Actiehoek 5°. TC-Tray.

Order nr.	109730101	109730200
Orig. nr.	TT6508R	TT6508RAF
Aantal stuks	8	8
Sleutels	mm	8 · 10 · 11 · 12 · 13 · 14 · 17 · 19
		AF / INCH
Ratel-steekringsleutels		5/16" · 3/8" · 7/16" · 1/2" · 9/16" · 5/8" · 11/16" · 3/4"
Afmetingen (l x b x h)	mm	265 x 142 x 50
		265 x 142 x 50
Prijs	€	126,00

TENGTTOOLS



Ratel-steekringsleutel. Vervaardigd uit hoogwaardig chroom vanadium staal. Matverchroomd. Identieke maten aan beide uiteinden. Ringkant 12-kant met hellingshoek 15° en handige omschakelknop voor het wijzigen van de draairichting. Aktiehoek 5°.

Order nr.	Orig. nr.	Maat mm	Maat inch	Lengte mm	Prijs €
109720102	600508R	8		140	17,50
109720201	600509R	9		150	17,50
109720300	600510R	10		159	18,50
109720409	600511R	11		165	20,50
109720508	600512R	12		172	21,50
109720607	600513R	13		178	22,50
109720706	600514R	14		191	23,50
109720805	600515R	15		200	24,50
109720904	600516R	16		208	26,90
109721001	600517R	17		226	26,90
109721100	600518R	18		237	29,00
109721209	600519R	19		248	29,50
109721308	600522R	22		290	39,90
109721407	600524R	24		323	49,00
109721506	600527R	27		359	88,00
109721605	600530R	30		403	105,00
109721704	600532R	32		425	122,00
109722009	600110R		5/16	140	19,50
109722108	600112R		3/8	159	20,50
109722207	600114R		7/16	165	21,50
109722306	600116R		1/2	178	23,90
109722405	600118R		9/16	191	25,00
109722504	600120R		5/8	208	28,50
109722603	600122R		11/16	226	28,50
109722702	600124R		3/4	248	31,50
109722801	600126R		13/16	290	41,50
109722900	600128R		7/8	323	41,50

TENGTTOOLS



Set van 8 ratel-steekringsleutels gaande van 8 tot 19mm. Identieke maten aan beide kanten van de sleutel. Model zonder omschakelknop. Platte sleutel. TC-tray.

Order nr.	166720102				
Orig. nr.	TT6508RS				
Aantal stuks	8				
Sleutels	mm	8 - 10 - 11 - 12 - 13 - 14 - 17 - 19			
Afmetingen (l x b x h)	mm	265 x 142 x 50			
Prijs	€	99,00			

TENGTTOOLS



Ratel-steekringsleutel. Plat. Model in CRV. Identieke maten aan beide uiteinden.

Order nr.	Orig. nr.	Maat mm	Lengte mm	Prijs €
162680102	600508RS	8	111	16,50
162680201	600509RS	9	123	16,90
162680300	600510RS	10	131	17,50
162680409	600511RS	11	147	17,50
162680508	600512RS	12	155	18,50
162680607	600513RS	13	164	18,90
162680706	600514RS	14	182	21,50
162680805	600515RS	15	192	22,90
162680904	600516RS	16	202	24,90
162681001	600517RS	17	223	24,90
162681100	600518RS	18	234	28,50
162681209	600519RS	19	246	28,50

TENGTTOOLS



Set van 8 swivel-ratel-steekringsleutels gaande van 8 tot 19mm. Swivel-zijde is 180° klinkbaar. Identieke maten aan beide kanten van de sleutel. TC-tray.

Order nr.	131900102			
Orig. nr.	TT6508RF			
Aantal stuks	8			
Ratel-steekringsleutels	8 - 10 - 11 - 12 - 13 - 14 - 17 - 19			
Afmetingen (l x b x h)	mm	265 x 142 x 50		
Prijs	€	115,00		

TENGTTOOLS



Ratel-steekringsleutel. Met 180° klinkbare ratelkant. Vervaardigd uit hoogwaardig Teng Tools chroom vanadium staal.

Matverchroomd. Identieke maten aan beide uiteinden. Ringkant 12-kant wijzigen de draairichting door het omdraaien van de sleutel. Aktiehoek 5°. Steeksleutel met hellingshoek 15°.

Order nr.	Orig. nr.	Maat mm	Lengte mm	Prijs €
131890105	600508RF	8	127	19,90
131890204	600509RF	9	131	20,50
131890303	600510RF	10	136	20,90
131890402	600511RF	11	141	21,90
131890501	600512RF	12	147	22,90
131890600	600513RF	13	154	23,90
131890709	600514RF	14	160	24,90
131890808	600515RF	15	169	24,90
131890907	600516RF	16	179	25,50
131891004	600517RF	17	190	27,50
131891103	600518RF	18	203	28,90
131891202	600519RF	19	215	29,50

TENGTOLS



Set van 12 lange steekringsleutels met dezelfde maat aan beide uiteinden. Ringkant 12-kant met hellingshoek 15°. Geleverd in een TTX-tray die geschikt is voor de Teng Tools koffers en gereedschapswagens.

Order nr.	185870102		
Orig. nr.	TTXLMP12		
Aantal stuks	12		
Maten	mm	8 - 9 - 10 - 11 - 12 - 13 - 14 - 15 - 16 - 17	- 18 - 19
Prijs	€	57,60	

TENGTOLS



Set van 9 extra-lange steekringsleutels gaande van 8 tot 19mm. De ringkant heeft een hellingshoek van 15°. Geleverd in een kunststof roltas.

Order nr.	116520107		
Orig. nr.	6059LMP		
Aantal stuks	9		
Maat	mm	8 - 10 - 11 - 12 - 13 - 14 - 15 - 17 - 19	
Prijs	€	49,50	

TENGTOLS



Steekringsleutels extra-lange uitvoering. Teng Tools chroom vanadium staal. Verchroomd en gepolijst. Identieke maten aan beide uiteinden. Hellingshoek ringkant 15°.

Order nr.	Orig. nr.	Maat mm	Maat inch	Lengte mm	Prijs €
116490103	605908	8		148	5,70
116490202	605909	9		158	6,00
116490301	605910	10		168	6,20
116490400	605911	11		188	6,20
116490509	605912	12		198	6,60
116490608	605913	13		208	6,70
116490707	605914	14		228	9,10
116490806	605915	15		238	10,00
116490905	605916	16		246	10,50
116491002	605917	17		266	12,50
116491101	605918	18		276	12,90
116491200	605919	19		285	14,00
116500901	601924		3/4	268	11,50
116500703	601920		5/8	208	5,70

Ringsleutels

TENGTOLS



Ringsleutel set. Uitvoering DIN 838. 12-kant ringkant. Dubbele gebogen 15° hoek. Chroom vanadium staal. Matverchroomd. Geleverd in een kartonnen doos.

Order nr.	185820107		185820206	
Orig. nr.	6308		6311	
Ringsleutels	mm	6x7 - 8x9 - 10x11 - 12x13 - 14x15 - 16x17 - 18x19 - 20x22	6x7 - 8x9 - 10x11 - 12x13 - 14x15 - 16x17 - 18x19 - 20x22 - 21x23 - 24x27 - 30x32	
Aantal stuks	8		11	
Prijs	€	45,90		77,00

LEIFELAN



AF / INCH

Set ringsleutels. Gaande van ofwel 1/4" tot 1", ofwel 1/4" tot 1 5/16" naargelang de set. Geleverd in een karton doos.

Order nr.	704312108		704312112	
Orig. nr.	I20431442108		I20431442112	
Aantal stuks	8		12	
Ringsleutels	inch	1/4x5/16 - 5/16x3/8 - 7/16x1/2 - 9/16x5/8 - 19/32x11/16 - 3/4x25/32 - 1	1/4x5/16 - 5/16x3/8 - 3/8x7/16 - 7/16x1/2 - 9/16x5/8 - 19/32x11/16 - 3/4x25/32 - 13/16x7/8 - 15/16x1 - 1 1/16x1 1/4 - 1 1/8x1 5/16 - 1 3/16x1 5/16	
Prijs	€	62,50		124,00

TENGTOLS



Set van 8 dubbele ringsleutels gaande van 6 tot 22mm. Geleverd in een roltas.

Order nr.	151640109		
Orig. nr.	6308MM		
Ringsleutels	mm	6x7 - 8x9 - 10x11 - 12x13 - 14x15 - 16x17 - 18x19 - 20x22	
Aantal stuks	8		
Prijs	€	47,90	



Set van 5 platte extra lange dubbele ringsleutels, van 8 tot 24 mm. Verschillende maten aan beide uiteinden. Satijn afwerking. Geleverd op een muurrek.

Order nr.	186220109		
Orig. nr.	WRFLS05		
Maten	mm	8x10 - 11x13 - 12x14 - 17x19 - 22x24	
Prijs	€	119,00	



Set van 11 dubbele ringsleutels gaande van 6 tot 32mm. TTX-tray.

Order nr.	68910157		
Orig. nr.	TTX6311		
Aantal stuks	11		
Ringsleutels	mm	6x7 - 8x9 - 10x11 - 12x13 - 14x15 - 16x17 - 18x19 - 20x22 - 21x23 - 24x27 - 30x32	
Afmetingen (l x b x h)	mm	560 x 110 x 40	
Prijs	€	93,00	



Compacte dubbele ringsleutel. Model Rigger Jigger. Maat 10x13mm. Lengte 120mm. Teng Tools chroom vanadium staal. Matverchroomd.

Order nr.	101660108		
Orig. nr.	601013		
Prijs	€	8,00	



Dubbele ringsleutel. Uitvoering DIN 838. 12-kant ringkanten. Dubbele gebogen 15° hoek. Chroom vanadium staal. Matverchroomd. Verschillende maten aan beide uiteinden. Teng Tools (63...) of Izeltas (IZ...).

Order nr.	Orig. nr.	Maat mm	Lengte mm	Maat inch	Prijs €
111960100	630607	6x7	168		7,40
111960209	630809	8x9	183		8,00
111960308	631011	10x11	198		9,10
111960407	631213	12x13	217		9,10
111960506	631415	14x15	239		10,50
111960605	631617	16x17	260		10,50
111960704	631819	18x19	292		12,50
111960803	632022	20x22	318		15,50
111960902	632123	21x23	326		17,50
111961009	632427	24x27	329		20,50
704302528	IZ0430442528	25x28	350,5		21,00
111961108	633032	30x32	362		24,90
704303236	IZ0430443236	32x36	401		26,00
704303641	IZ0430443641	36x41	438,5		47,50
704304146	IZ0430444146	41x46	486		65,00
704304650	IZ0430444650	46x50	536		90,00
704316080	IZ0431440608		176	1/4x5/16	6,40
704319011	IZ0431440911		206	3/8x7/16	7,00
704311112	IZ0431441112		220,5	7/16x1/2	7,50
704311214	IZ0431441214		220,5	1/2x9/16	8,10
704311415	IZ0431441415		236	9/16x19/32	9,50
704311416	IZ0431441416		236	9/16x5/8	10,00
704311517	IZ0431441517		250,5	19/32x11/16	10,50
704311920	IZ0431441920		271	3/4x25/32	12,50
704312122	IZ0431442122		310,5	13/16x7/8	15,50
704312325	IZ0431442325		331	15/16x1	23,00
704312631	IZ0431442631		371	1 1/6x1 1/4	27,00
704312833	IZ0431442833		371	1 1/8x1 5/16	29,00
704313033	IZ0431443033		371	1 3/16x1 5/16	29,00



Platte, dubbele ringsleutel. Satijn afwerking. Verschillende maten aan beide uiteinden.

Order nr.	Orig. nr.	Maat mm	Lengte mm	Prijs €
151610102	630810FL	8x10	265	20,50
151610151	631113FL	12x14	328	26,50
151610201	631214FL	12x14	328	26,50
151610300	631719FL	17x19	407	33,90
151610409	632224FL	22x24	430	43,50
151610250	631618FL	16x18	408	31,50



AF / INCH

Halve maansleutels. (Startersleutels). chroom vanadium staal. Matverchroomd. Verschillende maten aan beide uiteinden. De ringkant heeft een hoekstand van 15°.vv

Order nr.	Orig. nr.	Maat mm	Lengte mm	Maat inch	Prijs €
705301113	IZ0530441113	11x13	150		19,50
705301315	IZ0530441315	13x15	185		23,00
705301317	IZ0530441317	13x17	185		23,00
705301417	IZ0530441417	14x17	185		26,00
705301517	IZ0530441517	15x17	185		26,00
705301922	IZ0530441922	19x22	230		30,00
705311112	IZ0531441112		150	7/16x1/2	26,00
705311416	IZ0531441416		185	9/16x5/8	31,50



7-delige open pijpringsleutelset. Speciaal ontworpen om pijp- en slangkoppelingen te openen en aan te spannen. Ideaal voor beperkte ruimtes zoals hydraulische toepassingen. De ring ratel is eenvoudig te openen. 12-kant.

Order nr.	Orig. nr.	Maat mm	Lengte mm	Ringkant hoogte mm	Prijs €
186780102	TTXQRS07	13 14 16 22 24 27 32			209,00



Open pijpringsleutel. Speciaal ontworpen voor het los- en vastdraaien van pijp- en slangkoppelingen. Perfect voor kleine ruimtes zoals hydraulische inrichtingen. De ratel gaat eenvoudig en ingenieus open voor een gemakkelijke toegang tot de moer in de koppeling. 12-kant.

Order nr.	Orig. nr.	Maat mm	L mm	D mm	H1 mm	H2 mm	Prijs €
186790101	600813	13	141	27.5	7.2	8	25,90
186790200	600814	14	191	35.7	10	9	32,00
186790309	600816	16	191	35.7	10	9	32,00
186790408	600822	22	233	40.7	13	12	39,50
186790507	600824	24	235	43.2	13	12	44,90
186790606	600827	27	325	54.2	14.1	14.4	60,90
186790705	600832	32	325	58.5	15.9	14.4	64,90



Set van 6 dubbele ratel-ringsleutels 12-kant gaande van 6 tot 22mm. TC-tray.

Order nr.	Orig. nr.	Maat mm	Lengte mm	Ringkant hoogte mm	Prijs €
116700105	TTRORS	6			46,50



Dubbele ratel-ringsleutels. RORS-model. Teng Tools chroom vanadium staal. Matverchroomd. Verschillende maten aan beide uiteinden. Met hendel voor wijziging van draairichting. De ringkant heeft een hoekstand van 25°.

Order nr.	Orig. nr.	Maat mm	Lengte mm	Ringkant hoogte mm	Prijs €
116710104	680608	6x8	112	8	10,50
116710203	680709	7x9	133	8,4	12,50
116710302	681013	10x13	163	10,2	19,50
116710401	681214	12x14	172	10,2	19,50
116710500	681719	17x19	203	11	20,90
116710609	682122	21x22	235	11,4	22,50



Dubbele open-ringsleutels. Teng Tools chroom vanadium staal. Matverchroomd. Verschillende maten aan beide uiteinden. GRS2230 is geen Teng Tools sleutel.

Order nr.	Orig. nr.	Maat mm	Lengte mm	Maat inch	Hoogte mm	Prijs €
105840102	641011	10x11	152,4		7,9	6,50
105840201	641213	12x13	178,6		10,0	7,60
105840227	641314	13x14	178,6		10,0	7,90
105840243	641617	16x17	196,0		11,6	9,80
105840268	641922	19x22	207,7		13,8	11,50
724562230	GRS2230	22x30			-	35,90
105840300	661416		158,8	7/16 x 1/2	11,9	8,90



TENGOOLS



Slagrijnsleutels. Chroom vanadium staal. Zwart verchroomd.

Order nr.	Orig. nr.	Maat mm	Lengte mm	Prijs €
160750105	903024	24	162	21,50
160750204	903027	27	180	22,50
160750303	903030	30	190	27,50
160750402	903032	32	190	29,50
160750501	903036	36	205	33,50
160750600	903038	38	229	39,90
160750709	903041	41	240	41,50
160750808	903046	46	240	54,50
160750907	903050	50	255	57,50
160751004	903055	55	266	66,50
160751103	903060	60	280	72,50
160751202	903065	65	298	85,90
160751301	903070	70	330	119,00
160751400	903075	75	330	121,00
160751509	903080	80	335	253,00
160751608	903085	85	355	294,00
160751707	903090	90	395	362,00

TENGOOLS



Steekslagsleutel. Chroom vanadium staal. Zwart verchroomd.

Order nr.	Orig. nr.	Maat mm	Lengte mm	Prijs €
160740106	902024	24	178	22,90
160740205	902027	27	180	22,90
160740304	902030	30	190	28,50
160740403	902032	32	190	29,50
160740502	902036	36	214	38,00
160740601	902038	38	215	43,50
160740700	902041	41	233	44,90
160740809	902046	46	252	59,50
160740908	902050	50	275	67,50
160741005	902055	55	295	82,50
160741104	902060	60	315	98,90
160741203	902065	65	340	123,00
160741302	902070	70	370	155,00
160741401	902075	75	370	157,00
160741500	902080	80	397	319,00
160741609	902085	85	397	369,00
160741708	902090	90	444	419,00
160741807	902095	95	444	494,00
160741906	902100	100	488	595,00

Steeksleutels

TENGOOLS



Set Steeksleutel gaande van ofwel 6mm tot 22mm, ofwel 6mm tot 32mm naargelang de set. DIN3110. Chroom vanadium staal. Geleverd in een kartonnen doos.

Order nr.	185810108	185810207
Orig. nr.	6208	6211
Aantal stuks	8	11
Steeksleutels mm	6x7 · 8x9 · 10x11 · 12x13 · 14x15 · 16x17 · 18x19 · 20x22	6x7 · 8x9 · 10x11 · 12x13 · 14x15 · 16x17 · 18x19 · 20x22 · 21x23 · 24x27 · 30x32
Prijs €	26,90	49,90

UZELTA

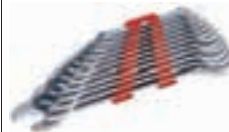

AF / INCH

Set steeksleutels gaande van ofwel 1/4" tot 1", ofwel 1/4" tot 1 5/16" naargelang de set. Geleverd in een kartonnen doos.

Order nr.	701611150	701611170
Orig. nr.	I20161442108	I20161442112
Aantal stuks	8	12
Steeksleutels inch	1/4x5/16 · 5/16x3/8 · 7/16x1/2 · 9/16x5/8 · 19/32x11/16 · 3/4x25/32 · 13/16x7/8 · 15/16x1	1/4x5/16 · 5/16x3/8 · 3/8x7/16 · 7/16x1/2 · 1/2x9/16 · 9/16x5/8 · 19/32x11/16 · 3/4x25/32 · 13/16x7/8 · 15/16x1 · 1 1/8x1 5/16
Prijs €	32,00	57,00

TENGOOLS



Set van 11 steeksleutels gaande van 6 tot 32mm. Geleverd in kunststof roltas. Chroom vanadium staal. DIN3110/ISO 3318.

Order nr.	151650108
Orig. nr.	6211MM
Aantal stuks	11
Steeksleutels mm	6x7 · 8x9 · 10x11 · 12x13 · 14x15 · 16x17 · 18x19 · 20x22 · 21x23 · 24x27 · 30x32
Prijs €	69,90

TENGOOLS



Set van 8 dubbele steeksleutels gaande van 6 tot 22mm. Chroom vanadium staal. TC-tray.

Order nr.	03900107
Orig. nr.	TT6208
Steeksleutels mm	6x7 · 8x9 · 10x11 · 12x13 · 14x15 · 16x17 · 18x19 · 20x22
Afmetingen (l x b x h) mm	265 x 142 x 50
Prijs €	31,90

TENGTTOOLS



Steeksleutels. Uitvoering DIN 3110 -ISO 3318. Chroom vanadium staal. Matverchromd. Verschillende maten aan beide uiteinden. Hellingshoek 15°. Teng Tools (62...) of Izeltas (IZ...).

Order nr.	Orig. nr.	Maat mm	Lengte mm	Prijs €
101700102	620607	6x7	123	3,80
101700201	620809	8x9	140	3,80
101700300	621011	10x11	156	5,20
101700409	621213	12x13	172	5,70
101700508	621415	14x15	189	6,30
101700607	621617	16x17	204	6,90
101700706	621819	18x19	221	7,70
101700805	622022	20x22	237	9,90
101700904	622123	21x23	247	11,50
101701001	622427	24x27	263	15,50
101701100	623032	30x32	298	19,50
701303036	IZ0130443036	30x36	325	17,50
701303641	IZ0130443641	36x41	360	31,00
701304146	IZ0130444146	41x46	400	53,00
701304650	IZ0130444650	46x50	450	59,50

IZELTAS



AF / INCH

Steeksleutel. Uitvoering DIN 3110 -ISO 3318. chroom vanadium staal. Matverchromd. Verschillende maten aan beide uiteinden. Hellingshoek sleutel 15°. Eenheid van verpakking: 10 stuks t.e.m. 18x19mm en 11/8"x15/16"; 5 stuks vanaf 19x21mm.

Order nr.	Orig. nr.	Lengte mm	Maat inch	Prijs €
701611020	IZ0161440809	107,5	5/16 x 3/8	3,20
701611030	IZ0161440811	121	5/16 x 7/16	3,40
701611040	IZ0161440911	121	3/8 x 7/16	3,30
701611050	IZ0161441112	135	7/16 x 1/2	3,70
701611060	IZ0161441214	148	1/2 x 9/16	4,50
701611070	IZ0161441416	156	9/16 x 5/8	5,10
701611080	IZ0161441417	168	9/16 x 11/16	4,80
701611090	IZ0161441517	168	19/32 x 11/16	5,90
701611100	IZ0161441619	168	5/8 x 3/4	6,60
701611110	IZ0161441920	185	3/4 x 25/32	7,70
701611120	IZ0161441921	185	3/4 x 7/8	8,90
701611130	IZ0161442021	185	25/32 x 13/16	7,30
701611180	IZ0161442122	206	13/16 x 7/8	8,90
701611190	IZ0161442325	220	15/16 x 1	9,70
701611200	IZ0161442328	235,5	15/16 x 1-1/8	8,80
701611210	IZ0161442628	53,2	1-1/16 x 1-1/8	13,50
701611220	IZ0161442631	235,5	11/16 x 1-1/4	13,50
701611230	IZ0161442833	250	1-1/8 x 1-5/16	14,50

IZELTAS



Sleutelhouder. Vervaardigd uit metaal. Universeel model geschikt voor 12 sleutels. Perfect te bevestigen aan de muur.

Order nr.	709000044
Orig. nr.	IZ8001316012
Prijs €	15,90

Pijpsleutels

TENGTTOOLS

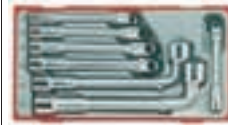

Pijpsleutelset gebogen 7dlg. In TC-tray.

Order nr.	118400100
Orig. nr.	ITAW07
Aantal	7
Maat mm	8 10 12 13 14 17 19
Prijs €	49,90

TENGTTOOLS



Gebogen pijpsleutels. Teng Tools chroom vanadium staal. Matverchromd. Identieke maten aan beide uiteinden. Met doorlopende schacht aan de korte kant. Met 6-kant en 12-kant aan elke kant van de sleutel.

Order nr.	Orig. nr.	Maat mm	Lengte mm	Prijs €
118360205	603509	9	122	7,00
118360403	603511	11	136	8,60
118360502	603512	12	145	9,00
118360809	603515	15	170	13,90
118360908	603516	16	178	13,90
118361104	603518	18	195	14,90
118361203	603519	19	205	14,90

Flexringsleutels

TENGOOLS



Set van 6 dubbele flex-ringsleutels 12-kant gaande van 8 tot 19mm. Verschillende maten aan beide kanten. TC-tray.

Order nr.	73000101 ⓘ				
Orig. nr.	TT6506				
Aantal stuks	6				
Sleutels	mm	8x9	10x11	12x13	14x15 · 16x17 · 18x19
Prijs	€	70,90			

TENGOOLS



Dubbele flex-ringsleutels 12-kant. Teng Tools chroom vanadium staal. Matverchromd. Verschillende maten aan beide uiteinden.

Order nr.	Orig. nr.	Maat mm	Maat inch	Lengte mm	Prijs €
72920200 ⓘ	650809	8x9		192	15,50
72920309 ⓘ	651011	10x11		200	16,50
72920358 ⓘ	651013	10x13		213	17,50
72920408 ⓘ	651213	12x13		218	17,90
72920507 ⓘ	651415	14x15		238	20,50
72920606 ⓘ	651617	16x17		264	22,50
72920705 ⓘ	651819	18x19		285	25,50
72921000 ⓘ	611214		3/8x7/16	200	23,50
72921109 ⓘ	611618		1/2x9/16	218	25,90
72921208 ⓘ	612022		5/8x11/16	264	31,00

TENGOOLS



Bi-flex sleutel. Met 1/4" hex-kant voor bitsen en 1/4" vierkant voor 1/4" doppen. Teng Tools chroom vanadium staal. Matverchromd. Geregistreerd product.

Order nr.	15580103 ⓘ				
Orig. nr.	691406				
Lengte	mm	200			
Prijs	€	17,90			

Opsteeksleutels

TENGOOLS



10-delige set bestaande uit 8 opsteek-ratelsleutels, 1 opsteek-ratelkop 3/8" en 1 opsteek-handvat 9x12mm. TC-tray.

Order nr.	118380104 ⓘ				
Orig. nr.	TTIG10				
Aantal stuks	10				
Ratelsleutels	mm	8 · 10 · 11 · 12 · 13 · 16 · 17 · 19			
Prijs	€	112,00			

TENGOOLS



Flexibel handvat met ringratel-kop adaptor 12-kant. Teng Tools chroom vanadium staal. Matverchromd.

Order nr.	118300102 ⓘ				
Orig. nr.	600010RI				
Lengte	mm	239			
Prijs	€	70,50			

TENGOOLS



Set van 8 opsteek-steeksleutels met 3/8" vierkant aansluiting gaande van 10 tot 19mm. Geleverd op een metalen rail met dopclips.

Order nr.	111990107 ⓘ				
Orig. nr.	M3808MM				
Maat	mm	10 · 11 · 12 · 13 · 16 · 17 · 18 · 19			
Aantal stuks	8				
Prijs	€	61,50			

TENGOOLS



Opsteek-steeksleutels met 3/8" vierkant-aansluiting. Teng Tools chroom vanadium staal. Matverchromd.

Order nr.	Orig. nr.	Maat mm	Maat inch	Lengte mm	Prijs €
112010103 ⓘ	M386510	10		32	9,30
112010202 ⓘ	M386511	11		34	9,50
112010301 ⓘ	M386512	12		36	13,50
112010400 ⓘ	M386513	13		37	9,80
112010509 ⓘ	M386514	14		40	9,90
112010608 ⓘ	M386515	15		41	10,50
112010707 ⓘ	M386516	16		41	14,90
112010806 ⓘ	M386517	17		45,5	11,00
112010905 ⓘ	M386518	18		45,5	11,50
112011002 ⓘ	M386519	19		45,5	11,90
112012505 ⓘ	M386122		11/16	45	10,50
112012000 ⓘ	M386112		3/8	30	9,10
112012208 ⓘ	M386116		1/2	36	8,40

Doorduwdoppen

TENGI TOOLS



Set van 15 doorsteekdoppen met ratel. Cap. 10-19mm. Speciaal voor het aan- en losdraaien van moeren op een lange doorgestoken schroefdraad. De doppen hebben een 3/8" aandrijving en een zeskant buitenkant maat 19mm. TC-tray.

Order nr.	143890101		
Orig. nr.	TTTH16		
Doppen 3/8" 6-kant	mm	10 · 11 · 12 · 13 · 14 · 15 · 16 · 17 · 18 · 19	
Ratel 3/8"	mm	19	
Verlengstukken 3/8"	mm	75	
Adaptors 3/8"		1 + 1 universal	
Bougiedooppen 3/8"	mm	16 · 21	
Prijs	€	77,50	

TENGI TOOLS



Ratel voor doorduw doppen. Interne hex 19mm aansluiting. Links-rechts verstelling dmv een hendel op de ratel.

Order nr.	144120102		
Orig. nr.	M800010		
Lengte	mm	220	
Interne Hex aansluiting	mm	19	
Prijs	€	41,90	

TENGI TOOLS



Doorduw doppen 32mm 6-kant. Externe hex aansluiting 19mm. Magnetisch rubber. Chroom Vanadium. De doppen zijn bedoeld voor gebruik met een lang-doorgaande draadstang.

Order nr.	Orig. nr.	Maat mm	Prijs €
144110103	M800510-C	10	6,40
144110202	M800511-C	11	6,40
144110301	M800512-C	12	6,60
144110400	M800513-C	13	6,70
144110509	M800514-C	14	7,00
144110608	M800515-C	15	7,60
144110707	M800516-C	16	8,30
144110806	M800517-C	17	8,30
144110905	M800518-C	18	9,20
144111002	M800519-C	19	9,20

TENGI TOOLS



Verlengstuk voor doorduw doppen. Te gebruiken samen met de doorduw-ratel M800010 en door-duw doppen M8005.

Order nr.	144130101		
Orig. nr.	M800023-C		
Aansluiting	inch	3/8	
Externe Hex aansluiting	mm	19	
Lengte	mm	75	
Prijs	€	9,80	

Montagesleutels

METALWORKS



Montage ringsleutel. Gesmeed staal. Zwart gefosfateerd.

Order nr.	Orig. nr.	Maat mm	Lengte mm	Breedte ring mm	Hoogte ring mm	Prijs €
721401700	ASHRNKP17	17	320	26	9	12,50
721401900	ASHRNKP19	19	320	30	10	16,50
721402200	ASHRNKP22	22	335	34	12	16,00
721402400	ASHRNKP24	24	355	38	12	19,00
721402600	ASHRNKP26	26	370	40	13	19,00
721402700	ASHRNKP27	27	370	42	14	22,50
721402900	ASHRNKP29	29	380	43	14	22,90
721403000	ASHRNKP30	30	390	46	14	28,00
721403200	ASHRNKP32	32	405	50	15	31,00
721403600	ASHRNKP36	36	440	56	16	36,50
721404100	ASHRNKP41	41	475	64	18	44,00

METALWORKS



Montage ratel-pin sleutels. Gesmeed staal. Zwart gefosfateerd.

Order nr.	Orig. nr.	Maat mm	Breedte ring mm	Hoogte ring mm	Prijs €
721391013	ASHRNKC1013	10x13	36	27	33,50
721391719	ASHRNKC1719	17x19	48	39	43,00
721391922	ASHRNKC1922	19x22	51	48	44,90
721392224	ASHRNKC2224	22x24	57	50	56,00
721392430	ASHRNKC2430	24x30	67	57	75,50
721392730	ASHRNKC2730	27x30	67	57	75,50
721393236	ASHRNKC3236	32x36	67	57	93,50

Haakpinsleutels

TENGOOLS



Set van 3 haakpinsleutels met 3 pin adaptors en 2 extra pinnen van 6 en 8mm. TC-tray.

Order nr.	102120102		
Orig. nr.	TTHP08		
Haakpinsleutels voor diameter	mm	19 - 50, 30 - 75, 50 - 120	
Pin adaptors met pin diameter	mm	4 - 5 - 6	
Extra pinnen diameter	mm	6 - 8	
Prijs	€	81,90	

TENGOOLS



Haakpinsleutels DIN 1804. Verstelbaar met vaste haak. Teng Tools chroom vanadium staal. Matverchromd.

Order nr.	Orig. nr.	Voor diameter mm	Lengte mm	Prijs €
112020102	HP101	19-50	145	22,50
112020201	HP102	32-75	178	29,90
112020300	HP103	50-120	247	39,50

TENGOOLS



Haakpinsleutels DIN 1816. Met vervangbare pin. Teng Tools chroom vanadium staal. Matverchromd.

Order nr.	Orig. nr.	Voor diameter mm	Lengte mm	Pin diameter mm	Prijs €
112030101	HP2014	19-50	145	4	34,50
112030200	HP2015	19-50	145	5	34,50
112030309	HP2025	32-75	178	5	47,50
112030408	HP2026	32-75	178	6	47,50
112030507	HP2036	50-120	247	6	54,50
112030606	HP2038	50-120	247	8	54,50

TENGOOLS



Accessoires. Pin voor Haaksleutel met pen. Voorkomt as- en borgmoerbeschadiging. Opening in het handvat voor gemakkelijke opslag.

Order nr.	Orig. nr.	Prijs €
801200600	HP2014-P	2,90
801200601	HP2015-P	3,60
801200603	HP2026-P	4,40
801200604	HP2036-P	4,40
801200605	HP2038-P	5,90

Schroefleutels

TENGOOLS



4-delige schroefleutelset. Met schaalverdeling. TC-tray.

Order nr.	166730101		
Orig. nr.	TTADJ04		
Capaciteit	mm	24 - 28 - 33 - 38	
Schroefleutels	mm	150 - 200 (2x) - 250	
Afmetingen (l x b x h)	mm	265 x 142 x 50	
Prijs	€	74,00	

TENGOOLS



Schroefleutels. Teng Tools chroom vanadium staal. Zwart-gefosfateerd. Met maat-aanduiding aan de sleutelkant.

Order nr.	Orig. nr.	Capaciteit mm	Lengte mm	Prijs €
105870059	4001	17	100	16,50
105870109	4002	24	150	17,50
105870208	4003	28	200	21,50
105870307	4004	33	250	26,90
105870406	4005	38	300	34,00
105870505	4006	50	375	72,00
105870604	4007	60	450	99,00
105870703	4008	70	600	209,00

TENGOOLS



Industriële schroefleutels. Chroom vanadium. Twee componenten handvat. Met schaalverdeling. Dankzij de 15° gebogen bek kan de sleutel in beperkte ruimtes gebruikt worden met een draaiing van 30°. Gefosfateerde afwerking.

Order nr.	Orig. nr.	Capaciteit mm	Lengte mm	Prijs €
178180105	4002IQ	24	157	19,50
178180204	4003IQ	28	206	23,50
178180303	4004IQ	33	255	29,90
178180402	4005IQ	38	305	34,50
178180501	4006IQ	50	380	65,90

TENGOOLS



Compacte en handige schroefsleutels - met groot bereik. Voorzien van een schaalverdeling. Met het nieuwe soft- +GRIP handvat voor een perfecte grip in de hand.

Order nr.	Orig. nr.	Lengte mm	Maximum opening mm	H mm	W mm	Prijs €
160380051	4002WT	172	34	30,0	63,5	27,50
160380101	4003WT	221	38	34,1	72,1	33,50
160380200	4004WT	274.6	50	41.0	92.1	38,00
160380309	4005WT	316.5	60	55.7	110.5	38,00

Buizen tangen

TENGOOLS



Buizen tangen. Robuust aluminium uitvoering. Licht gewicht.

Order nr.	Orig. nr.	Lengte mm	Capaciteit mm	Maximum pijpdiameter inch	Prijs €
151810108	PW12A	300	39	19/16	30,50
151810207	PW14A	350	47	17/8	34,50
151810306	PW18A	450	63	2 1/2	47,90
151810405	PW24A	600	76	3	69,50
151810504	PW36A	900	127	5	165,00

DELTA

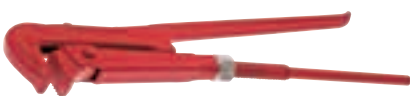

Buizen tang. Zweeds model. Tangbekken onder 85° hoek. Inductief nageharde bekken. chroom vanadium staal. Rood gepoederlakt.

Order nr.	Orig. nr.	Lengte mm	Capaciteit mm	Prijs €
722011000	IZ2201240010	325	40	43,50
722011500	IZ2201240015	430	60	63,50
722012000	IZ2201240020	585	70	94,50
722013000	IZ2201240030	690	100	136,00

Dopschroevendraaiers

TENGOOLS



Set van 9 Mega Drive schroevendraaiers op dop 6-kant gaande van 5 tot 13mm. Met een ergonomisch zwart-rood twee componenten handvat. TTX-tray.

Order nr.	114590102
Orig. nr.	TTXMDN
Maten	mm 5 - 5,5 - 6 - 7 - 8 - 10 - 11 - 12 - 13
Prijs	€ 68,90

TENGOOLS



Mega Drive schroevendraaiers op dop 6-kant. Met een ergonomisch zwart-rood twee componenten handvat.

Order nr.	Orig. nr.	Maat mm	Lengte schacht mm	Lengte handvat mm	Prijs €
112680103	MDN405	5	125	120	9,70
112680202	MDN4055	5,5	125	120	9,70
112680301	MDN406	6	125	120	9,70
112680400	MDN407	7	125	120	9,70
112680509	MDN408	8	125	120	9,90
112680608	MDN410	10	125	120	9,90
112680707	MDN411	11	125	120	10,50
112680806	MDN412	12	125	120	10,90
112680905	MDN413	13	125	120	11,90

TENGOOLS



Sleutel met T-handvat met lange dop 6-kant. Teng Tools chroom vanadium staal. Matverchroomd. Met een ergonomisch zwart-rood twee componenten handvat. lengte 288mm.

Order nr.	Orig. nr.	Maat mm	Prijs €
132180100	MDNT405	5	9,70
132180209	MDNT4055	5,5	9,70
132180308	MDNT406	6	9,70
132180407	MDNT407	7	10,50
132180506	MDNT408	8	10,50
132180605	MDNT409	9	11,90
132180704	MDNT410	10	12,90
132180803	MDNT411	11	12,90
132180902	MDNT412	12	12,90
132181009	MDNT413	13	14,50
132181108	MDNT414	14	15,50



Allensleutels

TENGOOLS



28-delige allensleutelset MM, AF en TX. Geleverd in 3 handige sets.

Order nr.	128250107	
Orig. nr.	TIHT28	
Maat	inch	5/64 - 3/32 - 1/8 - 5/32 - 3/16 - 7/32 - 1/4 - 5/16 (1479AF) - 3/8
Maat	mm	1,5 - 2 - 2,5 - 3 - 4 - 5 - 6 - 8 - 10 (1479mm)
Maat TX		8 - 9 - 10 - 15 - 20 - 25 - 27 - 30 - 40 (1479TX)
Allensleutel met ball-point	mm	7
Afmetingen (l x b x h)	mm	265 x 142 x 50
Prijs	€	41,90

TENGOOLS



Set van 10 allensleutels gaande van 1.5 tot 10mm of 1/16" tot 3/8". chroom vanadium staal. Zwart gefosfateerd. Geleverd met een ringhouder.

Order nr.	105820104	105820203
Orig. nr.	1425	1424
Aantal sleutels	10	10
Sleutels	mm	1,5 - 2 - 2,5 - 3 - 4 - 5 - 6 - 7 - 8 - 10
		1/16 - 5/64 - 3/32 - 1/8 - 5/32 - 3/16 - 7/32 - 1/4 - 5/16 - 3/8
Prijs	€	8,30
		9,10

TENGOOLS



Set van 7 allensleutels met bolkop gaande van 2,5 tot 10mm of 1/8" tot 3/8". chroom vanadium staal. Zwart gefosfateerd. Geleverd in een handige kunststof houder.

Order nr.	109550103	109550202
Orig. nr.	1475	1474
Maat	mm	1/8 - 5/32 - 3/16 - 7/32 - 1/4 - 5/16 - 3/8
Aantal stuks	7	7
Sleutels	mm	2,5 - 3 - 4 - 5 - 6 - 8 - 10
Sleutels	inch	1/8 - 5/32 - 3/16 - 7/32 - 1/4 - 5/16 - 3/8
Prijs	€	15,50
		16,50

TENGOOLS



Set van 9 allensleutels met bolkop gaande van 1,5 tot 10mm of 5/64" tot 3/8". chroom vanadium staal. Zwart gefosfateerd. Geleverd in een handige samenvouwbare kunststof houder.

Order nr.	112260104	112260203
Orig. nr.	1479MM	1479AF
Maat	mm	1,5 - 2 - 2,5 - 3 - 4 - 5 - 6 - 8 - 10
Maat	inch	5/64 - 3/32 - 1/8 - 5/32 - 3/16 - 7/32 - 1/4 - 5/16 - 3/8
Aantal stuks	9	9
Prijs	€	19,90
		22,50

TENGOOLS



7-delige allensleutelset in boekvorm gaande van 1,5 tot 6mm of 1/16" tot 7/32". Chroom vanadium staal. Zwart gefosfateerd. In alu houder.

Order nr.	151470101	151470200
Orig. nr.	1476NMM	1476NAF
Maat	mm	1,5 - 2 - 2,5 - 3 - 4 - 5 - 6
Maat	inch	1/16 - 5/64 - 3/32 - 1/8 - 5/32 - 3/16 - 7/32
Aantal stuks	7	7
Prijs	€	11,90
		11,90

TENGOOLS



Set van 8 sleutels in boekvorm plat, hex en TX. Chroom vanadium staal. Zwart gefosfateerd.

Order nr.	162670103
Orig. nr.	1477NX
Aantal sleutels	8
Hex sleutel	mm
TX sleutel	mm
PH sleutel	mm
Platte sleutel	mm
PZ sleutel	mm
Prijs	€
	20,50



Fiets sleutelset 11 delig. Chroom, nickel afwerking. In aluminium behuizing.

Order nr.	162640106
Orig. nr.	1473
Individuele accessoires	PH 2, TX25 Plat 1.0x5,5, Hex 2,0, 2,5, 3,0, 4,0, 5,0, 6,0 mm Bandenlichter Ketting tool
Prijs	€ 24,50



14 allensleutels in setvorm. Bestaande uit 7 extra-lange allensleutels van 3 tot 14mm en 7 allensleutels van 1,5 tot 6mm in boekvorm. Made in Japan. Hoogwaardige professionele kwaliteit. Chroom molybdeen. Zwart gefosfateerd.

Order nr.	205630106
Orig. nr.	205630106
Aantal stuks	14
Sleutels extra lang	mm 3 - 4 - 5 - 6 - 8 - 10 - 14
Sleutels in boekvorm	mm 1,5 - 2 - 2,5 - 3 - 4 - 5 - 6
Prijs	€ 60,50



L-vormige allensleutel. Chroom vanadium staal. Zwart gefosfateerd.

Order nr.	Orig. nr.	Lengte korte arm mm	Lengte lange arm mm	Maat mm	Maat inch	Prijs €
116560103	3105007	8	35	0,7		0,57
116560202	3105009	10	38	0,9		0,57
116560301	3105013	12	41	1,3		0,57
116560400	3105015	14	45	1,5		0,57
116560509	310502	16	50	2		0,57
116560608	3105025	18	56	2,5		0,57
116560707	310503	20	63	3		0,57
116560806	310504	25	70	4		0,79
116560905	3105045	26	75	4,5		0,68
116561002	310505	28	80	5		1,25
116561101	3105055	30	85	5,5		1,02
116561200	310506	32	90	6		1,25
116561309	310507	34	95	7		1,58
116561408	310508	36	100	8		2,40
116561507	310509	38	106	9		2,71
116561606	310510	40	112	10		3,40
116561705	310512	45	125	12		5,40
116561804	310514	56	140	14		7,90
116561903	310517	63	160	17		9,80
116562000	310519	70	180	19		13,50
116570102	310102	14	44		1/16	1,12
116570201	3101025	15	48		5/64	1,12

Order nr.	Orig. nr.	Lengte korte arm mm	Lengte lange arm mm	Maat mm	Maat inch	Prijs €
116570300	310103	17	51		3/32	1,12
116570409	3101035	18	54		7/64	1,12
116570508	310104	19	57		1/8	1,12
116570607	3101045	20	60		9/64	1,12
116570706	310105	21	64		5/32	1,12
116570805	310106	24	70		3/16	1,12
116570904	310107	26	76		7/32	1,12
116571001	310108	28	83		1/4	1,36
116571100	310110	32	95		5/16	2,14
116571209	310112	35	108		3/8	2,90
116571308	310114	38	121		7/16	4,95
116571407	310116	41	133		1/2	6,40



L-vormige allensleutel. Chroom vanadium staal. Zwart gefosfateerd. Met bolkop aan het lange uiteinde. Deze bolkop-uitvoering geeft u de mogelijkheid onder een hoek van 30° te werken.

Order nr.	Orig. nr.	Lengte korte arm mm	Lengte lange arm mm	Maat mm	Maat inch	Prijs €
122690100	3105015BL	14	77	1,5		2,50
122690209	310502BL	16	83	2		2,50
122690308	3105025BL	18	90	2,5		2,50
122690407	310503BL	20	98	3		2,50
122690506	310504BL	24	106	4		2,70
122690605	310505BL	28	118	5		3,30
122690704	310506BL	32	136	6		3,70
122690753	310507BL	34	147	7		4,40
122690803	310508BL	36	154	8		4,80
122690902	310510BL	40	172	10		7,30
177660107	3101025BL	15	82	2,0	5/64	1,60
177660206	310103BL	17	88	2,4	3/32	1,90
177660305	310104BL	19	96	3,2	1/8	2,00
177660404	310105BL	21	105	4,0	5/32	2,10
177660503	310106BL	24	114	4,8	3/16	2,10
177660602	310107BL	26	124	5,6	7/32	2,50
177660701	310108BL	28	135	6,4	1/4	2,60
177660800	310110BL	32	151	8,0	5/16	3,40
177660909	310112BL	35	170	9,5	3/8	4,30



Set van 7 allensleutels met T-hendel gaande van 2,5 tot 8mm of van 3/32" tot 5/16" voor de AF-set. Met bolkop aan de lange kant van de sleutel. TC-tray.

Order nr.	68930106	68930205
Orig. nr.	TTHX7	TTHX7AF
Aantal stuks	7	7
Sleutels	mm 2,5 - 3 - 4 - 5 - 6 - 7 - 8	
Maat	inch	3/32 - 1/8 - 5/32 - 3/16 - 7/32 - 1/4 - 5/16
Afmetingen (l x b x h)	mm 265 x 142 x 50	265 x 142 x 50
Prijs	€ 32,90	35,50

TENGOOLS



Set van 7 allensleutels met T-hendel. MM of AF. Met balkop aan de lange kant van de sleutel, voor een 30° draaiing. Geleverd op een wandrek. Voor montage op een muur of wandpaneel.

Order nr.	128260106	128260205
Orig. nr.	WRHEX07	WRHEX07AF
Aantal stuks	7	7
Sleutels	mm 2,5 - 3 - 4 - 5 - 6 - 7 - 8	3/32 - 1/8 - 5/32
Sleutels	inch	.3/16 - 7/32 - 1/4 - 5/16
Prijs	€ 40,00	34,90

TENGOOLS



L-vormige allensleutel met T-handvat. Chroom vanadium staal. Zwart gefosfateerd. Met balkop aan het lange uiteinde. Deze balkop-uitvoering geeft u de mogelijkheid onder een hoek van 30° te werken.

Order nr.	Orig. nr.	Lengte korte arm mm	Lengte lange arm mm	Maat mm	Maat inch	Prijs €
101790053	510502	12	100	2		6,70
101790103	5105025	12	100	2,5		7,60
101790202	510503	12	100	3		7,60
101790301	510504	12	100	4		7,90
101790400	510505	15	150	5		8,40
101790509	510506	15	150	6		8,90
101790608	510507	15	150	7		10,90
101790707	510508	18	190	8		10,50
101790806	510510	20	200	10		17,00
101790905	510512	20	200	12		19,50
101792000	510103	12	100		3/32	6,80
101792109	510104	12	100		1/8	7,10
101792208	510105	12	100		5/32	7,40
101792307	510106	15	150		3/16	8,10
101792406	510107	15	150		7/32	9,10
101792505	510108	15	150		1/4	10,90
101792604	510110	18	190		5/16	11,50

Torxsleutels

TENGOOLS



Set van 9 L-vormige TX-sleutels. Gaande van TX8 tot TX40. chroom vanadium staal. Zwart gefosfateerd. Geleverd in een handige opvouwbare kunststof houder. 1479TX1 is met balkop.

Order nr.	116600107	161610100
Orig. nr.	1479TX	1479TX1
Aantal stuks	9	9
Sleutels TX	8 - 9 - 10 - 15 - 20 - 25 - 27 - 30 - 40	8 - 9 - 10 - 15 - 20 - 25 - 27 - 30 - 40
Prijs	€ 23,50	30,90

TENGOOLS



Set van 8 TX-sleutels in boekvorm. Gaande van TX9 tot TX40. chroom vanadium staal. Zwart gefosfateerd. In alu houder. 1476NTX1 is met balkop.

Order nr.	151480100	162650105
Orig. nr.	1476NTX	1476NTX1
Aantal stuks	8	8
Sleutels TX	9 - 10 - 15 - 20 - 25 - 27 - 30 - 40	9 - 10 - 15 - 20 - 25 - 27 - 30 - 40
Prijs	€ 17,00	26,50

TENGOOLS



Set van 7 TX-sleutels. Gaande van TX8 tot TX40. chroom vanadium staal. Zwart gefosfateerd. Geleverd met een ringhouder.

Order nr.	105830103
Orig. nr.	1487
Aantal stuks	7
Sleutels TX	10 - 15 - 20 - 25 - 27 - 30 - 40
Prijs	€ 15,90

JAS Technicians kiest voor Teng Tools

De luchtvaart technici van de Wing F17, in de Zweedse stad van Ronneby, hebben onlangs beslist al hun oude gereedschapswagens door nieuwe van Teng Tools te vervangen. Een totaal van 26 gereedschapswagens van verschillende maten en met verschillende inhoud, die aan de specifieke behoeften van elke technicus beantwoorden, werden geleverd.

“De Teng Tools producten werden getest en gecontroleerd, en we zijn tevreden over de constante medewerking tussen ons centrum en Teng Tools” concludeert de dienstverantwoordelijke.

De luchtvaart technici van de F17 van Ronneby waren op zoek naar een praktische en moderne oplossing voor de opslag van hun gereedschap. Ze hebben natuurlijk voor Teng Tools gekozen. “We hebben de Teng Tools gereedschapswagens gekozen, voor hun mobiliteit,



flexibiliteit en kwaliteit”, zegt Magnus Kjellson, hoofd van de afdeling in de FM LOG, onderhoudsverantwoordelijke voor de vliegtuigen van de F17.

De wagens werden eerst zonder gereedschap geleverd, zodat elke technicus de geschikte werktuigen volgens zijn eigen specialiteit kon kiezen. Een

voortdurend proces, daar werktuigen nog altijd vervangen en toegevoegd kunnen worden, totdat de optimale oplossing gevonden wordt.

Gezien elk vliegtuig 40 computers bezit, is een gemakkelijke toegang tot goed gereedschap noodzakelijk. Hetgeen Teng Tools ongetwijfeld aanbiedt!



TENGTOOLS



TX L-sleutels. Chroom vanadium staal. Zwart gefosfateerd. Beide kanten gefreesd.

Order nr.	Orig. nr.	Lengte mm	Maat TX	Prijs €
172830101	320008	16x80	8	2,50
172830200	320009	16x83	9	2,50
172830309	320010	17x86	10	2,80
172830408	320015	18x90	15	2,90
172830507	320020	19x95	20	3,00
172830606	320025	20x100	25	3,30
172830705	320027	22x105	27	3,50
172830804	320030	24x114	30	3,80
172830903	320040	26x124	40	4,10
172831000	320045	29x133	45	5,00
172831109	320050	32x152	50	5,60

TENGTOOLS



L-vormige Torx-ballpoint sleutel. Chroom vanadium staal. Zwart gefosfateerd. Met balkop aan het lange uiteinde. Deze balkop-uitvoering geeft u de mogelijkheid onder een hoek van 20° te werken.

Order nr.	Orig. nr.	Lengte mm	Maat TX	Prijs €
166980102	3200BL TX8	16x80	8	3,60
166980201	3200BL TX9	16x83	9	3,60
166980300	3200BL TX10	17x86	10	3,70
166980409	3200BL TX15	18x90	15	3,70
166980508	3200BL TX20	19x95	20	3,80
166980607	3200BL TX25	20x100	25	3,80
166980706	3200BL TX27	22x105	27	3,90
166980805	3200BL TX30	24x114	30	4,40
166980904	3200BL TX40	26x124	40	4,20
166981001	3200BL TX45	29x133	45	5,40
166981100	3200BL TX50	32x152	50	5,70

TENGTOOLS



L-vormige TX-TPX sleutel met T-handvat. chroom vanadium staal. Zwart gefosfateerd. Met TPX-maten aan de korte kant van de sleutel.

TENGTOOLS



Set van 7 sleutels TX/TPX met T-handel. Gaande van TX-TPX10 tot TX-TPX40. Met TPX aan de korte kant van de sleutel. TC-tray.

Order nr.	68920107	
Orig. nr.	TTTTX7	
Aantal stuks	7	
Sleutels TX	10 · 15 · 20 · 25 · 27 · 30 · 40	
Afmetingen (l x b x h)	mm	265 x 142 x 50
Prijs	€	33,90

Order nr.	Orig. nr.	Lengte mm	Maat TX/TPX	Prijs €
101800050	520009	12x100	9	6,90
101800100	520010	12x100	10	6,90
101800209	520015	12x100	15	6,90
101800308	520020	12x100	20	8,30
101800407	520025	15x150	25	8,90
101800506	520027	15x150	27	8,90
101800605	520030	15x150	30	8,90
101800704	520040	18x190	40	9,50
101800803	520045	20x200	45	10,50
101800902	520050	20x200	50	13,50
101801009	520055	20x200	55	16,50



Teng Tools Schroevendraaiers

Teng Tools schroevendraaierbladen zijn gemaakt van TT-MV materiaal, deze geven een 20 tot 30% hogere torsie dan normaal chroom vanadium staal.

TT-MV heeft een speciaal molybdenum materiaal dat een 56 Rockwell harding heeft. Onafhankelijke testen tonen aan dat de Teng Tools schroevendraaiers tot de beste klasse horen. Dit komt onder andere door de hogere torsie en het moment van het breken, en uitbrek testen, dit toont aan dat ze van profi kwaliteit zijn.



Schroeven- draaiers

- De zeskant schacht op de langere maten heeft het voordeel dat men er een steeksleutel of schroef sleutel op kan zetten voor nog meer torsie, en kracht.
- Leverbaar in diverse soorten en maten, de tips zijn voorzien van een gefosfateerde beschermlaag.
- Ronde en elips gevormde handgrepen voor een perfect aandraaimoment.
- De schroevendraaiers hebben een ophangoog die tevens ook de mogelijkheid geeft om hem als T-greep te gebruiken.
- De Megadrive schroevendraaiers zijn verkrijgbaar met PH, PZ, Torx TX, Torx TPX, Sleufkop en Robinson kop.
- Ook mini(horloge/telefoon) schroevendraaiers en speciale kracht schroevendraaiers (MDT serie) zitten in het assortiment. Deze hebben een doorlopende kling tot boven in de handgreep, alleen leverbaar met sleufkop en PH kop.
- De Megadrive schroevendraaiers zijn los verkrijgbaar, in sets en in de Teng Tools tool trays.



Schroevendraaiers

TENGOOLS



53-delige Super Mega Drive Set. Bestaat uit 19 schroevendraaiers plat, PH en PZ, 1 bitsratel en 33 bitsen L.25mm. Met een ergonomisch zwart-rood twee componenten handvat. Geleverd in een handige afsluitbare kunstof koffer.

Order nr.	144310109	
Orig. nr.	MD9053N	
Schroevendraaiers Plat	mm	10x200 - 8x150 - 6,5x150 - 6,5x100 - 5,5x150 - 5,5x75 - 4x100 - 3x100 - 3x75 - 6x38 (stubby)
Bitsen PZ		0
Aantal stuks		53
Bitschroevendraaier met bitsen Plat	mm	1,2x5 - 1,4x7
Schroevendraaiers PH		1x75 - 2x100 - 2x38 - 3x150
Schroevendraaiers PZ		0x75 - 1x75 - 2x100 - 2x38 - 3x150
Bitschroevendraaier met bitsen PH		1 - 2
Bitschroevendraaier met bitsen PZ		1 - 2
Bitsen TX		6 - 7 - 8 - 9 - 10 - 15 (x2) - 20 (x2) - 27 - 30 - 40
Bitsen TPX		20 - 25 - 30
Bitsen SQ		1 - 2 - 3
Bitsen Hex	mm	2 - 3 - 4 - 5 - 6 - 8
Prijs	€	96,50

TENGOOLS



Set van 10 schroevendraaiers Plat, PZ en PH. Met een ergonomisch zwart-rood twee componenten handvat. Geleverd in een kunstof afsluitbare koffer.

Order nr.	185880101	
Orig. nr.	MD910N	
Schroevendraaiers Plat	mm	3.0x100 - 5.5x75 - 5.5x150 - 6.5x150
Schroevendraaiers PH	mm	0x75 - 1x75 - 2x100
Schroevendraaiers PZ	mm	1x75 - 2x100
Schroevendraaiers Plat 1000 volt	mm	3.0x100
Prijs	€	39,90

TENGOOLS



Set van 6 schroevendraaiers plat, PZ en PH. Met een ergonomisch zwart-rood twee componenten handvat. Geleverd in een kunstof tray.

Order nr.	178200101	
Orig. nr.	MD906N	
Schroevendraaiers Plat	mm	0,6x3,5-75 - 1,0x5,5-150
Schroevendraaiers PH	mm	1x75 - 2x100
Schroevendraaiers PZ	mm	1x75 - 2x100
Prijs	€	22,90

TENGOOLS



Set van 6 schroevendraaiers TX. Met een ergonomisch zwart-rood twee componenten handvat. Geleverd in een kunstof tray.

Order nr.	178200200	
Orig. nr.	MD906N1	
Schroevendraaiers TX	mm	10x100 - 15x100 - 20x100 - 25x100 - 30x100 - 40x100
Prijs	€	24,50

TENGOOLS



Set van 6 schroevendraaiers TX en PZ. Met een ergonomisch zwart-rood twee componenten handvat. Geleverd in een kunstof tray.

Order nr.	185890100	
Orig. nr.	MD906N2	
Schroevendraaiers PZ	mm	1x75 - 2x100
Schroevendraaiers TX	mm	10 - 15 - 20 - 25
Prijs	€	20,90

TENGOOLS



Set van 6 Mega Drive schroevendraaiers plat en PH. Met een ergonomisch zwart-rood twee componenten handvat. Geleverd in een handige kunstof koffer. Ook verkrijgbaar in display.

Order nr.	185900107	
Orig. nr.	MD906N3	
Schroevendraaiers		Plat 0,5x3-75mm - Plat 1x5,5-75mm - Plat 1,2x6,5-100mm - PH0x75mm - PH1x75mm - PH2x100mm
Prijs	€	19,90

TENGOOLS

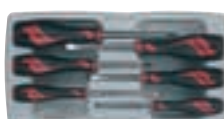

Set van 6 schroevendraaiers Plat en PZ. Met een ergonomisch zwart-rood twee componenten handvat. Geleverd in een kunstof tray.

Order nr.	185910106	
Orig. nr.	MD906N4	
Schroevendraaiers Plat	mm	3.0x75 - 4.0x100 - 5.5x75 - 6.5x100
Schroevendraaiers PZ	mm	1x75 - 2x100
Prijs	€	19,90



TENGOOLS



Set van 12 schroevendraaiers plat, PH en PZ. Met een ergonomisch zwart-rood twee componenten handvat. Geleverd in een kunstof tray.

Order nr.	178210100		
Orig. nr.	MD912N		
Schroevendraaiers Plat	mm	0,5x2,5x75 - 0,6x3,5x100 - 0,8x4,0x150 - 1,0x5,5x150 - 1,2x6,5x150 - 1,6x10x200	
Schroevendraaiers PH	mm	0(x75) - 1(x75) - 2(x100) - 2(x200)	
Schroevendraaiers PZ	(mm)	1(x75) - 2(x100)	
Prijs	€	41,90	

TENGOOLS



Set van 12 schroevendraaiers Plat, PH, PZ en TX. Drie 1000V geïsoleerde schroevendraaiers. Met een ergonomisch zwart-rood twee componenten handvat. Geleverd in een kunstof tray.

Order nr.	178210209		
Orig. nr.	MD912N1		
Schroevendraaiers Plat	mm	0,5x3,0x75 - 0,6x3,5-100 - 1,0x5,5x150	
Schroevendraaiers PH	mm	1(x75) - 2(x100)	
Schroevendraaiers TX	(mm)	20(x100) - 25(x100) - 30(x100)	
Schroevendraaiers PZ	(mm)	2(x100)	
Schroevendraaiers geïsoleerd PH	(mm)	1(x80)	
Schroevendraaiers geïsoleerd Plat	mm	0,4x2,5x75 - 0,5x3x100	
Prijs	€	29,90	

TENGOOLS



Set van 10 Mega Drive schroevendraaiers plat, Ph en Pz. Met een ergonomisch zwart-rood twee componenten handvat. Geleverd met een wandrek voor montage op een muur of wandpaneel.

Order nr.	174510107		
Orig. nr.	WRMD10N		
Schroevendraaiers Plat	mm	0,5x3,0x100 - 1,0x5,5x75 - 1,0x5,5x150 - 1,2x6,5x150 - 1,2x8,0x150	
Schroevendraaiers PH		0x75 - 1x75 - 2x100	
Schroevendraaiers PZ		1x75 - 1x100	
Prijs	€	49,00	

TENGOOLS



Set van 5 schroevendraaiers met doorgaande schacht uit TT-MV PLUS staal. Ergonomisch twee-componenten handvat. Geleverd met een wandrek voor opknoping op een paneel of muur.

Order nr.	185970100		
Orig. nr.	WRMDT05N		
MDT932N plat	mm	1,2x6,5x100	
MDT934N plat	mm	1,2x8x150	
MDT935N plat	mm	1,6x10x200	
MDT952N PH	mm	2x100	
MDT953N PH	mm	3x150	
Prijs	€	33,90	

TENGOOLS

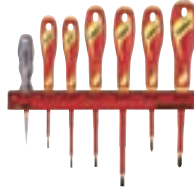

Order nr.	174520205		
Orig. nr.	WRMDV07N		
Schroevendraaiers Plat	mm	0,4x2,5x75mm, 0,5x3,0x100mm, 0,8x4,0x100mm, 1,0x5,5x125mm	
Schroevendraaiers PH	mm	PH1x80mm, PH2x100mm	
Voltage tester		100V/250V	
Prijs	€	32,90	

TENGOOLS



Set van 14 schroevendraaiers plat, PH en PZ in Teng TTD tray. Met een ergonomisch zwart-rood twee componenten handvat.

Order nr.	174370106		
Orig. nr.	TTD914N		
Schroevendraaiers Plat	mm	0,5x3x75 - 0,6x3,5x100 - 1,0x5,5x75 - 1,2x6,5x38 - 1,0x5,5x125 - 1,2x6,5x100	
Schroevendraaiers PH	mm	0(x75) - 1(x75) - 2(x38) - 2(x100)	
Schroevendraaiers PZ	(mm)	0(x75) - 1(x75) - 2(x38) - 2(x100)	
Afmetingen (l x b x h)	mm	265 x 142 x 50	
Prijs	€	53,90	

TENGOOLS

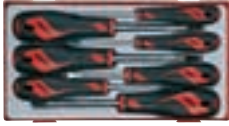

Set van 7 schroevendraaiers plat, PH en PZ. TT-MV PLUS staal. Ergonomisch twee componenten handvat met ophanggat. TC tray.

Order nr.	174400101		
Orig. nr.	TT917N		
Schroevendraaiers Plat	mm	0,5x3x75 - 1x5,5x75 - 0,2x6,5x100	
Schroevendraaiers PH	mm	0x75 - 1x75 - 2x75	
Schroevendraaiers PZ	mm	2x100	
Prijs	€	27,90	

TENGOOLS



5-delige schroevendraaierset plat en PH waarvan 2 stubby. TTX-tray.

Order nr.	174500108		
Orig. nr.	TTX918N		
Schroevendraaiers Plat	mm	1,2x6,5x38 - 0,5x3x100 - 1,2x6,5x100 - 1,6x10x200 - 1,0x5,5x150 - 1,2x8x150	
Schroevendraaiers PH	mm	2x38 - 3x150	
Prijs	€	46,50	

TENGOOLS



Set van 12 schroevendraaiers TX in Teng TTD tray. Met een ergonomisch zwart-rood twee componenten handvat.

Order nr.	174380105		
Orig. nr.	TTD912TXN		
Schroevendraaiers TX	(mm)	6(x75) - 7(x75) - 8(x75) - 9(x75) - 10(x100) - 15(x100) - 20(x100) - 25(x100) - 27(x100) - 30(x100) - 40(x100) - 45(x100)	
Afmetingen (l x b x h)	mm	265 x 142 x 50	
Prijs	€	49,90	

TENGOOLS

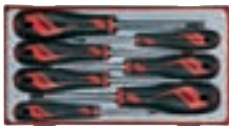

Set van 7 TX/TPX schroevendraaiers. TT-MV PLUS staal. Ergonomisch twee componenten handvat met ophanggat. TC tray.

Order nr.	174410100		
Orig. nr.	TT917TXN		
Schroevendraaiers TX	(mm)	8(x75) - 9(x75)	
Schroevendraaiers TPX	(mm)	10(x100) - 15(x100) - 20(x100) - 25(x100) - 30(x100)	
Afmetingen (l x b x h)	mm	265 x 142 x 50	
Prijs	€	27,90	

TENGOOLS



5-delige set power-thru schroevendraaierset plat en PH met zeskant schacht en slagkop. TTX-tray.

Order nr.	174490102		
Orig. nr.	TTXMDTN		
Schroevendraaiers Plat	mm	1,2x6,5x100 - 1,2x8,0x150 - 1,6x10x200	
Schroevendraaiers PH	mm	2x100 - 3x150	
Afmetingen (l x b x h)	mm	560 x 110 x 40	
Prijs	€	37,90	

TENGOOLS



Set van 9 Mega Drive schroevendraaiers op dop 6-kant gaande van 5 tot 13mm. Met een ergonomisch zwart-rood twee componenten handvat. TTX-tray.

Order nr.	114590102		
Orig. nr.	TTXMDN		
Maten	mm	5 - 5,5 - 6 - 7 - 8 - 10 - 11 - 12 - 13	
Prijs	€	68,90	

TENGOOLS



Set van 11 lange dubbelzijdige bitsen Plat, PH en PZ met een ergonomisch zwart-rood twee componenten handvat. TC-tray.

Order nr.	128650108		
Orig. nr.	TTMD12D		
Schacht PH	1x2 - 1x6,5		
Schacht Plat	mm	4,0x5,5	
Schacht PZ	1x2		
Schacht TX	10x15 - 20x25 - 30x40		
Maat Hex	mm	3x3 met bolkop, 4x4 met bolkop, 5x5 met bolkop, 6x6 met bolkop	
Prijs	€	33,50	

TENGOOLS



Wisselstukken voor de set TTMD12D.

Order nr.	Orig. nr.	Omschrijving	Prijs €
128650207	MD901	Handvat	8,60
128650306	PHH0102	Lange bits PH1xPH2	7,50
128650405	FTF4055	Lange bits 4,0x5,5	7,50
128650603	PZZ0102	Lange bits PZ1xPZ2	7,50
128650702	TXH1015	Lange bits TX10xTX15	7,50
128650801	TXH2025	Lange bits TX20xTX25	7,50
128650900	TXH3040	Lange bits TX30xTX40	7,50
128651007	HBH0303	Lange bits (hex)-3x3mm bolkop	8,30
128651106	HBH0404	Lange bits (hex)-4x4mm bolkop	8,30
128651205	HDH0505	Lange bits (hex)-5x5mm bolkop	8,30
128651304	HBH0606	Lange bits (hex)-6x6mm bolkop	8,30
128650504	PHF0365	Lange bits PH3x6,5mm plat	7,50

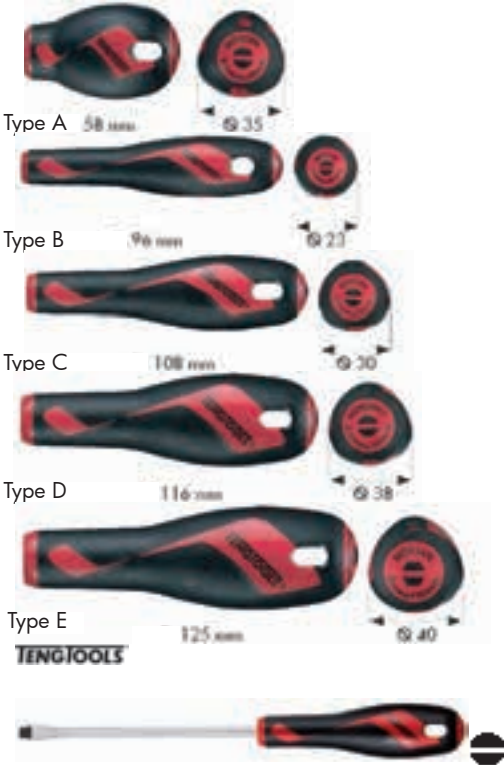

Schroevendraaier met TT-MV PLUS stalen schacht. Zwarte tip. De punten tot 0,8 mm zijn parallel, de grotere zijn uitlopend. Ergonomisch twee-componenten handvat met ophanggat.

Order nr.	Orig. nr.	Lengte schacht	Lengte handvat	Schacht	Maat plat	Handvat type	Type	Prijs
		mm	mm		mm			€
177760105	MD914N	50	96	Rond	0.4x2.5	B	plat	4,35
177760204	MD915N	75	96	Rond	0.4x2.5	B	plat	4,35
177760303	MD915N1	200	96	Rond	0.5x2.5	B	plat	4,35
177760402	MD920N	75	96	Rond	0.5x3.0	B	plat	4,35
177760501	MD920N1	100	96	Rond	0.5x3.0	B	plat	4,35
177760600	MD916N	75	96	Rond	0.6x3.5	B	plat	4,55
177760709	MD916N1	100	96	Rond	0.6x3.5	B	plat	4,55
177760808	MD916N2	150	96	Rond	0.6x3.5	B	plat	4,55
177760907	MD917N	100	96	Rond	0.8x4.0	B	plat	4,75
177761004	MD917N1	400	96	Rond	0.8x4.0	B	plat	6,30
177761103	MD917N2	150	96	Rond	0.8x4.0	B	plat	4,55
177761152	MD922N	75	108	Rond	1.5x5.5	C	plat	6,00
177761202	MD923N	150	108	Rond	1.0x5.5	C	plat	6,60
177761301	MD923N1	200	108	Rond	1.0x5.5	C	plat	6,20
177761400	MD928N	38	58	rond	1.2x6.5	A	plat	5,20
177761509	MD928N1	100	116	Rond	1.2x6.5	D	plat	6,60
177761608	MD928N2	150	116	Rond	1.2x6.5	D	plat	6,30
177761707	MD928N3	200	116	Rond	1.2x6.5	D	plat	7,20
177761558	MD928N4	100	108	Rond	1.2x6.5	C	plat	6,20
177761657	MD928N5	150	108	Rond	1.2x6.5	C	plat	6,60
177761756	MD928N6	200	108	Rond	1.2x6.5	C	plat	7,20
177762259	MD928N7	400	108	Rond	1.2x6.5	C	plat	10,50
177761806	MD930N	200	125	Rond	1.6x10	E	plat	10,50
177761608	MD931N	125	108	Hex	1.0x5.5	C	plat	6,20
177762002	MD932N	100	116	Hex	1.2x6.5	D	plat	7,70
177762101	MD932N1	150	116	Hex	1.2x6.5	D	plat	7,00
177762200	MD932N2	400	116	Hex	1.2x6.5	D	plat	16,50
177762309	MD934N	150	125	Hex	1.2x8.0	E	plat	11,50
177762408	MD935N	200	125	Hex	1.6x10.0	E	plat	12,50

TENGOOLS



Schroevendraaier met ronde of zeskant schacht uit TT-MV PLUS staal. Zwarte tip. Ergonomisch twee-componenten handvat met ophanggat.

Order nr.	Orig. nr.	Lengte schacht	Lengte handvat	Schacht	Maat PH	Handvat type	Type	Prijs
		mm	mm					€
177770104	MD940N	75	96	Rond	0	B	PH	4,35
177770203	MD940N1	300	96	Rond	0	B	PH	5,40
177770401	MD947N1	75	108	Rond	1	C	PH	5,10
177770500	MD947N2	150	108	Rond	1	C	PH	5,60
177770708	MD948N1	100	116	Rond	2	D	PH	6,50
177770807	MD948N2	200	116	Rond	2	D	PH	7,30
177770906	MD948N3	400	116	Rond	2	D	PH	10,50
177770757	MD948N4	100	108	Rond	2	C	PH	6,30
177770856	MD948N5	200	108	Rond	2	C	PH	7,30
177770955	MD948N6	400	108	Rond	2	C	PH	10,50
177770831	MD948N8	300	108	Rond	2	C	PH	8,70
177771003	MD949N	150	125	Rond	3	E	PH	9,00
177771102	MD950N	200	125	Rond	4	E	PH	10,90
177771201	MD952N	100	116	Hex	2	D	PH	7,70
177771300	MD952N1	400	116	Hex	2	D	PH	16,50
177771409	MD953N	150	125	Hex	3	E	PH	11,50
177771508	MD954N	200	125	Hex	4	E	PH	10,90

TENGOOLS



Schroevendraaier. Met ronde of zeskant schacht uit TT-MV PLUS staal. Zwarte tip. Ergonomisch twee-componenten handvat met ophanggat.

Order nr.	Orig. nr.	Lengte schacht	Lengte handvat	Maat PZ	Schacht	Handvat type	Type	Prijs
		mm	mm					€
177780103	MD960N	75	96	0	Rond	B	PZ	4,75
177780202	MD961N	75	108	1	Rond	C	PZ	5,90
177780301	MD961N1	250	108	1	Rond	C	PZ	6,40
177780509	MD962N	100	116	2	Rond	D	PZ	6,10
177780608	MD962N1	150	116	2	Rond	D	PZ	6,80
177780707	MD962N2	100	116	2	Hex	D	PZ	6,60
177780459	MD962N4	100	108	2	Rond	C	PZ	6,30
177780467	MD962N4A	200	108	2	Rond	C	PZ	7,20
177780483	MD962N4C	300	108	2	Rond	C	PZ	8,60
177780491	MD962N4D	400	108	2	Rond	C	PZ	10,50
177780475	MD962N5	150	108	3	Rond	C	PZ	6,50
177780905	MD963N	150	125	3	Hex	E	PZ	9,20
177781002	MD964N	200	125	4	Hex	E	PZ	8,40



TENGTOOLS



Schroevendraaier met TPX tip. Met ronde schacht uit TT-MV PLUS staal. Zwarte tip. Ergonomisch twee-componenten handvat met ophanggat.

Order nr.	Orig. nr.	Lengte schacht	Lengte handvat	Maat TX	Handvat type	Type	Prijs
		mm	mm				€
177790102	MD906TN	75	96	6	B	TX	3,90
177790201	MD907TN	75	96	7	B	TX	3,90
177790300	MD908TN	75	96	8	B	TX	4,00
177790409	MD909TN	75	96	9	B	TX	4,00
177790508	MD910TN	100	108	10	C	TX	4,95
177790607	MD915TN	100	108	15	C	TX	5,20
177790706	MD920TN	100	108	20	C	TX	5,20
177790805	MD925TN	100	116	25	D	TX	6,40
177790904	MD927TN	100	116	27	D	TX	6,40
177791001	MD930TN	100	116	30	D	TX	6,40
177791100	MD940TN	100	116	40	D	TX	6,40
177791209	MD945TN	125	125	45	E	TX	8,80

TENGTOOLS



Schroevendraaier voor TPX veiligheidsschroeven. Met ronde schacht uit TT-MV PLUS staal. Zwarte tip. Ergonomisch twee-componenten handvat met ophanggat.

Order nr.	Orig. nr.	Lengte schacht	Lengte handvat	Handvat type	Maat TPX	Type	Prijs
		mm	mm				€
177800109	MD610TPN	100	108	C	10	TPX	6,10
177800208	MD615TPN	100	108	C	15	TPX	6,10
177800307	MD620TPN	100	108	C	20	TPX	7,50
177800406	MD625TPN	100	116	D	25	TPX	7,40
177800505	MD627TPN	100	116	D	27	TPX	7,40
177800604	MD630TPN	100	116	D	30	TPX	7,40
177800703	MD640TPN	100	120	D	40	TPX	8,00

TENGTOOLS



Schroevendraaier met ronde schacht uit TT-MV PLUS staal. Zwarte tip. Ergonomisch twee-componenten handvat met ophanggat.

Order nr.	Orig. nr.	Lengte schacht	Lengte handvat	Schacht intern	Hex mm	Handvat type	Type	Prijs
		mm	mm		mm			€
177810108	MD7020HBN	100	96	Rond	2	B	Hex	3,70
177810207	MD7025HBN	100	96	Rond	2.5	B	Hex	3,70
177810306	MD7030HBN	100	96	Rond	3	B	Hex	3,40

TENGTOOLS



Schroevendraaier. Zeskant tip met balpen Allen voor een draaiing tot een hoek van 30°. Ronde schacht uit TT-MV PLUS staal. Zwarte tip. Ergonomisch twee-componenten handvat met ophanggat.

Order nr.	Orig. nr.	Lengte schacht	Lengte handvat	Schacht	Hex mm	Maat	Handvat type	Type	Prijs
		mm	mm		mm				€
177820107	MD7020HBN	100	96	Rond	2	B	Hex	Hex	3,85
177820206	MD7025HBN	100	96	Rond	2,5	B	Hex	Hex	3,85
177820305	MD7030HBN	150	96	Rond	3	B	Hex	Hex	4,25
177820404	MD7040HBN	150	108	Rond	4	C	Hex	Hex	4,75
177820503	MD7050HBN	150	116	Rond	5	D	Hex	Hex	5,60
177820602	MD7060HBN	150	116	Rond	6	D	Hex	Hex	7,30
177820701	MD7080HBN	150	125	Rond	8	E	Hex	Hex	9,90

TENGTOOLS



Schroevendraaier voor vierkante koppen zoals Robertson type. Met een ronde schacht uit TT-MV PLUS staal. Zwarte tip. Ergonomisch twee-componenten handvat met ophanggat.

Order nr.	Orig. nr.	Lengte schacht	Lengte handvat	Maat Rob	Handvat type	Type	Prijs
		mm	mm				€
177830106	MD801N	100	116	1	D	Rob	6,60
177830205	MD802N	100	116	2	D	Rob	6,60
177830304	MD803N	100	116	3	D	Rob	6,60

TENGTOOLS



Slagschroevendraaier met een TT-MV PLUS stalen doorlopende schacht en met een stalen dop op handvat. De zeskant schacht laat het gebruik van een sleutel toe om deze goed vast te houden. Ergonomisch twee-componenten handvat met ophanggat.

Order nr.	Orig. nr.	Lengte schacht	Lengte handvat	Schacht	Maat plat	Handvat type	Type	Prijs
		mm	mm		mm			€
177840105	MDT932N	100	116	Hex	1.2x6.5	D	plat	9,50
177840204	MDT934N	150	125	Hex	1.2x8	E	plat	13,90
177840303	MDT935N	200	125	Hex	1.6x10	E	plat	15,50

TENGTTOOLS



Slagschroevendraaier met een TT-MV PLUS stalen doorlopende schacht en met een stalen dop op handvat. De zeskant schacht laat het gebruik van een sleutel toe om deze goed vast te houden. Ergonomisch twee-componenten handvat met ophanggat.

Order nr.	177840402	T	177840501	T
Orig. nr.	MDT952N		MDT953N	
Lengte schacht	mm	100	150	
Lengte handvat	mm	116	125	
Schacht		Hex	Hex	
Handvat type		D	E	
Maat PH		2	3	
Type		PH	PH	
Prijs	€	9,30	13,90	

TENGTTOOLS

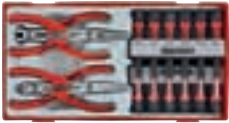

16-delige set bestaande uit 12 mini-schroevendraaiers Plat, Ph en Tx en 4 mini-tangen. TC-tray.

Order nr.	104450101	T
Orig. nr.	TTM116	
Schroevendraaiers Plat	mm	2,0x40 - 2,4x40 - 3,0x40
Schroevendraaiers PH	mm	00(x40) - 0(x40)
Schroevendraaiers TX	(mm)	6 - 7 - 8 - 9 - 10 - 15
Tang kopknip	mm	114
Zijkniptang	mm	125
Lange bektang	mm	125
Prijs	€	62,90

TENGTTOOLS

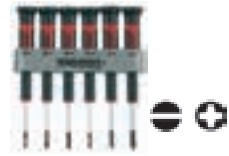

Set van 6 mini-schroevendraaiers Plat en PH. TT-MV staal. Zwarte tip. Geleverd met een rekje voor wandmontage.

Order nr.	68940105	T
Orig. nr.	MDM706	
Schroevendraaiers Plat	mm	2x40 - 2,4x40 - 3x40
Schroevendraaiers PH		00 - 0 - 1
Prijs	€	22,50

TENGTTOOLS



Set van 6 mini-schroevendraaiers. TT-MV staal. Zwarte tip. Geleverd met een rekje voor wandmontage.

Order nr.	102150109	T
Orig. nr.	MDM706TX	
Schroevendraaiers TX		6 - 7 - 8 - 9 - 10 - 15
Prijs	€	22,50

TENGTTOOLS

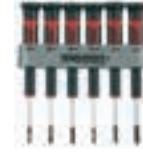

Individuele mini-schroevendraaiers voor MDM706 en MDM706TX.

Order nr.	Orig. nr.	Plat mm	Maat PH	Maat Hex	Maat TX	Prijs €
68940139	MDM711			2		5,60
68940162	MDM712			2,5		5,60
68940204	MDM713	2				5,60
68940303	MDM714	2,4				5,60
68940402	MDM715	3				5,60
68940501	MDM716		00			5,60
68940600	MDM717		0			5,60
68940709	MDM718		1			5,60
102151008	MDM806				6	5,90
102151107	MDM807				7	5,90
102151206	MDM808				8	5,90
102151305	MDM809				9	5,90
102151404	MDM810				10	5,90
102151503	MDM815				15	5,90

METALWORKS



Electronica microset 47 dlg. 3 in 1. Ideaal voor alle vakmannen voor elektronica, fabricage van juwelen en optica. Bestaat uit 3 kleine sets met elk een handvat.

Order nr.	801000090	T
Orig. nr.	PB47	
Aantal stuks		47
Bitsen plat	mm	0,6 - 0,8 - 1,0 - 1,2 - 1,4 - 1,5(x2) - 1,6 - 1,7 - 1,8 - 2,0(x3) - 2,2 - 2,5(x2) - 3,0 - 4,0
Bitsen PH		000 - 00 - 0 - 1,0 - 1,5 - 2,0(x2) - 2,5
Bitsen TX		5(x2) - 6(x2) - 7(x2) - 8(x2) - 9(x2) - 10(x2) - 15 - 20
Bitsen Triangle		3,0
Bitsen Y		3,5
Bitsen Star		1,6
Bitsen SP		2
Prijs	€	34,90

TENGTTOOLS



Set van 7 lange bitsen. L. 120mm 1/4" plat, PH en TX en een bitshandvat. Bitsen zijn 2-zijdig bruikbaar. Geleverd in een handige mini-Teng box.

Order nr.	172280109	T
Orig. nr.	TM708	
Schroevendraaiers		Plat 2,0mm x PH00 - Plat 3,0mm x PH0 - Plat 4,0mm x PH1 - PZOxPZ1 - TX5xTX7 - TX6xTX8 - TX9xTX10
Prijs	€	16,50

Schroevendraaiers & bitsen

TENGOOLS

Individuele accessoires uit de set TM708.

Order nr.	Orig. nr.	Omschrijving	Prijs €
118120203	MDM700	Handvat	4,30
118120302	2912512	Combi-schacht 0,3x2,0 - PH00	5,80
118120401	2912513	Combi-schacht 0,4x3,0 - PH0	5,80
118120500	2912514	Combi-schacht 0,5x4,0 - PH1	5,80
118120609	2912520	Combi-schacht PZ0-PZ1	5,80
118120708	2912535	Combi-schacht TX5 - TX7	5,80
118120807	2912537	Combi-schacht TX6 - TX8	5,80
118120906	2912539	Combi-schacht TX9 - TX10	5,80

TENGOOLS



Schroevendraaier "Stubby" voor PZ sleufkop. Ronde schacht uit TT-MV PLUS staal. Zwarte tip. Ergonomisch twee-componenten handvat met ophanggat.

Order nr.	177780400	177780806
Orig. nr.	MD961N2	MD962N3
Lengte schacht	mm 38	38
Lengte handvat	mm 58	58
Tip	PZ1	PZ2
Prijs	€ 4,90	4,75

TENGOOLS



Schroevendraaier "Stubby" voor PH sleufkop. Ronde schacht uit TT-MV PLUS staal. Zwarte tip. Ergonomisch twee-componenten handvat met ophanggat. DIN 5260.

Order nr.	177770302	177770609
Orig. nr.	MD947N	MD948N
Lengte schacht	mm 38	38
Lengte handvat	mm 58	58
Tip	PH1	PH2
Prijs	€ 5,20	5,40

TENGOOLS



Compacte bitsen Schroevendraaier voor 1/4" bitsen, met magneet die zowel de bits als de schroef vasthoudt. Twee componenten handvat met ophanggat.

Order nr.	185840105
Orig. nr.	MDBH
Prijs	€ 6,20

TENGOOLS



Compacte bitsen Schroevendraaier met 8 bitsen 1/4 hex, L-25 mm.

Order nr.	185920105
Orig. nr.	MD908N
Bitsen plat	mm 6.5 - 8.0
Bitsen PH	1 - 2
Bitsen PZ	1 - 2
Bitsen Hex	mm 4 - 5
Prijs	€ 8,40

TENGOOLS



Schroevendraaier met 1/4" opnamedop. Met ingebouwde magneet die zowel de bits als de schroef vasthoudt. Kunststof handvat met opbergruimte voor bitsen. Geleverd met 6 bitsen: 2 Platte, 2 Phillips en 2 Pozidriv.

Order nr.	72570104
Orig. nr.	MD907
Lengte schacht	mm 100
Lengte handvat	mm 120
Bitsen	Plat 1,2x5mm - Plat 1,4x7mm - PH1 - PH2 - PZ1 - PZ2
Prijs	€ 16,90

TENGOOLS



Schroevendraaier met 1/4" opnamedop. Met ingebouwde magneet die zowel de bits als de schroef vasthoudt. Kunststof handvat met opbergruimte voor bitsen. Geleverd met 6 torx bitsen.

Order nr.	101910107
Orig. nr.	MD907TX
Lengte schacht	mm 100
Lengte handvat	mm 120
Bitsen TX	10 - 15 - 20 - 25 - 27 - 30
Prijs	€ 17,90

TENGOOLS



Bitsenratel voor 1/4" bitsen, met magneet voor het vasthouden van de bits en de schroef. Twee componenten handvat met ophanggat. Inclusief 6 bitsen en een adapter opgeslagen in het handvat.

Order nr.	186560108
Orig. nr.	MDR908
Bitsen plat	mm 5-7
Bitsen PH	1-2
Bitsen PZ	1-2
Adaptor	1/4"
Aansluiting	inch 1/4"
Prijs	€ 14,90

TENGOOLS



Stubby bitsratel Schroevendraaier voor 1/4" bitsen. Met magneet dat zowel de bits als de schroef vasthoudt. Twee-componentenhandvat. Incl. 6 bits en adaptor, opgeborgen in het handvat.

Order nr.	186550109
Orig. nr.	MDR908S
Bitsen plat	mm 5-7
Bitsen PH	1-2
Bitsen PZ	1-2
Adaptor	1/4"
Aansluiting	inch 1/4"
Prijs	€ 13,90

Schroevendraaiers 1000V



TENGOOLS

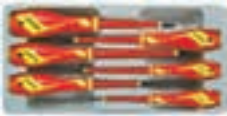

Set van 6 platte en PH schroevendraaiers. Schacht bedekt met 2 lagen in verschillende kleuren. Met geïsoleerde handgreep en schacht. Conform EN 60900 voor werk onder voltage tot 1000V (door gekwalificeerde elektriciens). Geleverd in een kunstof tray.

Order nr.	178200309
Orig. nr.	MDV906N
Schroevendraaiers Plat	mm 0,4x2,5x75 - 0,5x3,0x100 - 0,8x4,0x100 - 1,0x5,5x125
Schroevendraaiers PH	mm 1(x80) - 2(x100)
Prijs	€ 22,50

TENGOOLS

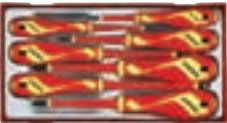

Set van 7 1000V-schroevendraaiers plat, PZ en PH in Teng TC tray, bestaande uit 3 platte schroevendraaiers, 3 PH Schroevendraaiers en 1 PZ schroevendraaier. Met geïsoleerde handgreep en schacht. TC-tray.

Order nr.	178710109
Orig. nr.	TTV907N
Schroevendraaiers Plat	mm 2,5x75 - 4x100 - 5,5x125
Schroevendraaiers PH	mm 0(x60) - 1(x80) - 2(x100)
Schroevendraaiers PZ	(mm) 2(x100)
Afmetingen (l x b x h)	mm 265 x 142 x 50
Prijs	€ 30,90

TENGOOLS



Set van 10 schroevendraaiers 1000-V plat, PH en PZ in TTD tray.

Order nr.	174390104
Orig. nr.	TTDV910N
Schroevendraaiers Plat	mm 0,4x2,5x75 - 0,5x3,0x100 - 0,8x4,0x100 - 1,0x5,5x125
Schroevendraaiers PH	0 - 1 - 2
Schroevendraaiers PZ	0 - 1 - 2
Afmetingen (l x b x h)	mm 265 x 142 x 50
Prijs	€ 38,90

TENGOOLS



Schroevendraaiers 1000V op muurrek.

Order nr.	174520106
Orig. nr.	WRMDV05N
Maat PH	0x75 - 1x75
Maat PZ	1x75
Schroevendraaiers Plat	mm 0,5x3,0x100 - 1,0x5,5x75
Prijs	€ 29,90

TENGOOLS



Geïsoleerde schroevendraaier. Zwarte tip. Met ophanggat.

Order nr.	Orig. nr.	Maat plat	Lengte schacht	Lengte handvat	Handvat type	Prijs
		mm	mm	mm		€
177870102	MDV820N	0,4x2,5	75	175	B	5,90
177870201	MDV822N	0,5x3,0	100	96	B	5,90
177870300	MDV824N	0,8x4,0	100	108	C	6,80
177870409	MDV826N	1,0x5,5	125	108	C	8,10
177870508	MDV828N	1,2x6,5	150	116	D	10,50

TENGOOLS



Geïsoleerde schroevendraaier. Zwarte tip. Ergonomisch twee-componenten handvat met ophanggat.

Order nr.	Orig. nr.	Lengte schacht	Lengte handvat	Maat PH	Handvat type	Prijs
		mm	mm			€
177880101	MDV840N	60	96	0	B	5,90
177880200	MDV842N	80	108	1	C	7,50
177880309	MDV844N	100	225	2	D	9,60
177880408	MDV846N	150	290	3	E	12,50

TENGTTOOLS



Geïsoleerde schroevendraaier. Zwarte tip. Ergonomisch twee-componenten handvat met ophanggat.

Order nr.	Orig. nr.	Lengte schacht mm	Lengte handvat mm	Maat PZ	Handvat type	Prijs €
177890100	MDV860N	60	96	0	B	6,60
177890209	MDV862N	80	108	1	C	7,50
177890308	MDV864N	100	116	2	D	9,60
177890407	MDV866N	150	125	3	E	13,50

TENGTTOOLS



Geïsoleerde schroevendraaier voor vierkante koppen zoals Robertson type. Schacht bedekt met 2 lagen in verschillende kleuren. Met geïsoleerde handgreep en schacht. Conform EN 60900 voor werk onder voltage tot 1000 V.

Order nr.	186590105
Orig. nr.	MDV802N
Lengte schacht	mm 100
Maat Rob	2
Handvat type	D
Handvat lengte	mm 116
Prijs	€ 7,30

TENGTTOOLS



Geïsoleerde schroevendraaier voor plus-min schroeven (Phillips/plat of Pozidriv/plat). Schacht bedekt met 2 lagen in verschillende kleuren. Met geïsoleerde handgreep en schacht. Conform EN 60900 voor werk onder voltage tot 1000 V.

Order nr.	186590204	186590303
Orig. nr.	MDV844NF	MDV864NF
Lengte schacht	mm 100	100
Handvat type	D	D
Handvat lengte	mm 116	116
Maat	plat/PH2	plat/PZ2
Prijs	€ 7,40	7,40

TENGTTOOLS



Geïsoleerde spanningstester voor 100-250V.

Order nr.	186610101
Orig. nr.	MDV9855
Lengte schacht	mm 70
Lengte handvat	mm 75
Prijs	€ 5,40

Bitsen

TENGTTOOLS



Bitset 1/4" met magnetische bitshouder. Verpakt in een typische mini-Tengbox. Ook verkrijgbaar in display.

Order nr.	102610102	102630100	102620101
Orig. nr.	BBX07A	BBX07TXA	BBX10A
Aantal stuks	7	7	10
Bitsen 1/4" plat	mm 1,0x5,5 - 1,2x6,5		0,6x4,5 - 1,0x5,5 - 1,2x6,5
Bitsen 1/4" PH	1 - 2		1 - 2 - 3
Bitsen 1/4" PZ	1 - 2		1 - 2 - 3
Bitsen 1/4" TX		10 - 15 - 20 - 25 - 30 - 40	
Prijs	€ 13,90	14,50	16,90

TENGTTOOLS



Set van 27 van de meeste gebruikte bitsen. L.25mm 1/4" met bitshouder. Verpakt in een typische mini-Tengbox. Ook verkrijgbaar in display.

Order nr.	172390106
Orig. nr.	TM028
Aantal stuks	28
Bitsen 1/4" plat	mm 0,6x4 - 0,8x5,5 - 1x6,5
Bitsen 1/4" PH	1 - 2 - 3
Bitsen 1/4" PZ	1 - 2 - 3
Bitsen 1/4" TX	10 - 15 - 20 - 25 - 30 - 40
Bitsen 1/4" Rob	1 - 2 - 3
Bitsen 1/4" Hex	mm 4 - 5 - 6
Bitsen 1/4" GR	2 (x2)
Bitsen 1/4" TPX	20 - 25 - 30
Adaptor Hex 1/4"	inch 1/4
Prijs	€ 19,90

TENGOOLS



29-delige mini bitset 1/4".
Bestaande uit 1 mini-handratel
1/4", 1 bitshouder en 27 bitsen.
Geleverd in een kunststof doos met
klikslot.

Order nr.	167360106	
Orig. nr.	TM029	
Aantal stuks	29	
Bitsen plat	mm	4,5 - 5,5 - 6,5
Bitsen PH		1 - 2 - 3
Bitsen PZ		1 - 2 - 3
Bitsen TX		10 - 15 - 20 - 25 - 30 - 40
Bitsen TPX		20 - 25 - 30
Bitsen Rob		1 - 2 - 3
Bitsen Hex	mm	4 - 5 - 6
Bitsen GR		2 (x2)
Accessoires 1/4" aansluiting	bitshouder 50mm - bitsratel 8mm - hex adaptor M/F	
Prijs	€	26,90

TENGOOLS



74 delige set. Bevat Ratel bit
schroevendraaier, 6" flexibel
verlengstuk, 4" verlengstuk, 1/4" M
x 1/4" hex adaptor, koppel
adaptor en 69 bitsen. TC-tray.

Order nr.	144030103	
Orig. nr.	TMD74	
Bitsen 1/4" Hex aansluiting 25mm plat	mm	0,6x3,5 - 0,6x4,5 - 0,8x4 - 0,8x5,5 - 1x5,5 - 1,2x5 - 1,2x6,5 - 1,4x7 - 1,6x8
Bitsen 1/4" Hex aansluiting 25mm PH		1 (x4) - 2(x7) - 3
Bitsen 1/4" Hex aansluiting 25mm PZ		1 (x4) - 2(x7) - 3
Bitsen 1/4" Hex aansluiting 25mm TX		6 - 7 - 8 - 9 - 10 - 15 - 20 (x3) - 25 (x3) - 27 - 30 - 40
Bitsen 1/4" Hex aansluiting 25mm TPX		10 - 15 - 20 (x2) - 25 (x2) - 27 - 30 - 40
Bitsen 1/4" Hex aansluiting 25mm Hex	mm	2 - 3 - 4 - 5 - 6 - 8
Bitsen 1/4" Hex aansluiting 25mm SQ		1 - 2 - 3
Bitsen 1/4" Hex aansluiting 25mm GR		2 (x3)
Prijs	€	37,90

TENGOOLS



Mini bitsratel 1/4" L.90mm met aan de andere sleutelzijde een
8mm ringopname. Chroom-vanadium. Verchroomde uitvoering.

Order nr.	118340108	
Orig. nr.	1400B	
Lengte	mm	90
Prijs	€	22,50

TENGOOLS



Schroevendraaier met 1/4"-opnadedop. met ingebouwde
magneet die zowel de bits als de schroef vasthoudt. Zeskant
chroom vanadium schacht. Kunststof handvat met ophang-
opening.

Order nr.	100240100	
Orig. nr.	MD900	
Lengte schacht	mm	100
Lengte handvat	mm	120
Prijs	€	13,50

TENGOOLS



Schroevendraaier voor slangklemmen. Met flexibele schacht voor
een goede toegankelijkheid. Met omwisselbare dop van 6 en
7mm. Totale lengte 260mm.

Order nr.	68180108	
Prijs	€	13,90

TENGOOLS



Bi-ervangdop 6 en 7mm voor
MD503.

Order nr.	61180207	
Prijs	€	1,70

TENGOOLS



Schroevendraaier voor slangklemmen met flexibel schat. Geschikt
voor 7mm slangklemmen. Totale lengte van 270mm.

Order nr.	117720102	
Prijs	€	10,50

TENGOOLS



Bitshouder met snelspanbitshouder.
Met 1/4" hex-aansluiting. Lengte
50mm.

Order nr.	106170103	
Orig. nr.	ACC50CBH01	
Prijs	€	10,90

TENGOOLS



Bitshouder met verzonken magneet.
Met 1/4" hex-aansluiting.

Order nr.	106160104	106160203
Orig. nr.	ACC50MBH01	ACC70MBH01
Lengte	mm	50
Prijs	€	5,50
		8,60

TENGOOLS



Adaptor met 1/4" hex en vierkant - aansluitingen. Voor gebruik met standaard slagdoppen ed. Voor gebruik met machines met 1/4" hex-aandrijving. Lengte 50mm.

Order nr.	Orig. nr.	Aansluiting inch	Prijs €
106180102 T	ACCSDA1414	1/4	5,70
106180201 T	ACCSDA1438	3/8	8,60
106180300 T	ACCSDA1412	1/2	10,50

TENGOOLS



Magnetische bitshouder met verzonken magneet met hex-aansluiting. Voor gebruik in elektrische boormachines. Lengte 45mm.

Order nr.	Orig. nr.	Maat inch	Maat mm	Type	Prijs €
111730107 T	NS45108M	1/4		magnetisch	5,50
111730305 T	NS45506M		6	magnetisch	5,50
111730503 T	NS4508M		8	magnetisch	6,20
111730354 T	NS4507M		7	magnetisch	5,80
111730602 T	NS4508R		8	ring	6,20

TENGOOLS



Bits. Plat type. L.25 of 70mm met 1/4" Hex-aandrijving. VE = verpakkingseenheid

Order nr.	Orig. nr.	Maat PH	Type	Lengte mm	Maat plat mm	VE	Prijs/VE €
106041007 T	FL2506A10		plat	25	0,6x3,5	10	7,70
106040108 T	FL2506A03		plat	25	0,6x3,5	3	3,72
106040207 T	FL2506B03		plat	25	0,6x4,5	3	4,05
106040306 T	FL2508A03		plat	25	0,6x4,5	3	3,72
106040405 T	FL2508B03		plat	25	0,8x5,5	3	3,72
106040504 T	FL2510A03		plat	25	1,0x5,5	3	3,72
106040702 T	FL2516A03		plat	25	1,6x8,0	3	5,20
106041403 T	FL2510A10		plat	25	1,0x5,5	10	7,10
106041601 T	FL2516A10		plat	25	1,6x8,0	10	11,50
106041106 T	FL2506B10		plat	25	0,6x4,5	10	7,70
106041205 T	FL2508A10		plat	25	0,8x4	10	7,70
106040603 T	FL2512A03		plat	25	1,2x6,5	3	4,05
106051006 T	FL7006A02		plat	70	0,6x3,5	2	6,40
106051204 T	FL7008B02		plat	70	0,8x5,5	2	6,40
106050107 T	FL5006A03		plat		0,6x3,5	3	6,00
106050206 T	FL5008A03		plat		0,8x4,0	3	6,00
106050305 T	FL5008B03		plat		0,8x5,5	3	6,00
106050404 T	FL5010A03		plat		1,0x5,5	3	6,00
106050503 T	FL5012A03		plat		1,2x6,5	3	6,00
106051105 T	FL7008A02		plat		0,8x4,0	2	6,00
106051303 T	FL7010A02		plat		1,0x5,5	2	6,00
106280100 T	GR25002010	2	PH			25	12,50
106281009 T	GR25002100	2	PH			100	52,90

TENGOOLS



Bits. Phillips type. L.25mm met 1/4" Hex-aandrijving. VE = verpakkingseenheid.

Order nr.	Orig. nr.	Maat PH	Type	VE	Prijs/VE €
106060106 T	PH2500103	1	PH	3	3,93
106060403 T	PH2500110	1	PH	10	8,20
106060205 T	PH2500203	2	PH	3	3,93
106060502 T	PH2500210	2	PH	10	8,20
106060304 T	PH2500303	3	PH	3	3,93
106060601 T	PH2500310	3	PH	10	8,20

TENGOOLS



Bits. Hex type. L.25mm. Beschikt over 1/4" Hex-aandrijving. VE = verpakkingseenheid.

Order nr.	Orig. nr.	Type	Maat Hex mm	VE	Prijs/VE €
106100100 T	HEX2500203	Hex	2	3	3,93
106100209 T	HEX2500303	Hex	3	3	3,93
106100308 T	HEX2500403	Hex	4	3	3,93
106100407 T	HEX2500503	Hex	5	3	3,93
106100506 T	HEX2500603	Hex	6	3	3,93
106100605 T	HEX2500803	Hex	8	3	5,10

TENGOOLS



Lange bits. Phillips type. L.50mm met 1/4" Hex-aandrijving. VE = verpakkingseenheid.

Order nr.	Orig. nr.	Maat PH	Type	VE	Prijs/VE €
106070105 T	PH5000103	1	PH	3	6,20
106070204 T	PH5000203	2	PH	3	6,20
106070303 T	PH5000303	3	PH	3	6,20

TENGOOLS



Extra-lange bits. Phillips type. L.70mm met 1/4" Hex-aandrijving. VE = verpakkingseenheid

Order nr.	Orig. nr.	Maat PH	Type	VE	Prijs/VE €
106070402 T	PH7000102	1	PH	2	6,20
106070501 T	PH7000202	2	PH	2	6,20

TENGOOLS



Bits. Pozidriv type. L.25mm met 1/4" Hex-aandrijving. VE = verpakkingseenheid.

Order nr.	Orig. nr.	Type	Lengte mm	Maat PZ	VE	Prijs/VE €
106080104 T	PZ2500103	PZ	25	1	3	4,05
106081003 T	PZ2500110	PZ	25	1	10	8,20
106080203 T	PZ2500203	PZ	25	2	3	4,05
106081102 T	PZ2500210	PZ	25	2	10	8,20
106080302 T	PZ2500303	PZ	25	3	3	4,05
106081201 T	PZ2500310	PZ	25	3	10	8,20



TENGITOOLS



Lange bits. Pozidriv type. L.50mm met 1/4" Hex-aandrijving. VE = verpakkingseenheid.

Order nr.	Orig. nr.	Type	Maat PZ	VE	Prijs/VE €
106090103 T	PZ5000103	PZ	1	3	6,20
106090202 T	PZ5000203	PZ	2	3	6,20
106090301 T	PZ5000303	PZ	3	3	6,20

TENGITOOLS



Extra-lange bits. Pozidriv type. L.70mm met 1/4" Hex-aandrijving. VE = verpakkingseenheid.

Order nr.	Orig. nr.	Type	Maat PZ	VE	Prijs/VE €
106090400 T	PZ7000102	PZ	1	2	6,20
106090509 T	PZ7000202	PZ	2	2	6,20

TENGITOOLS



Bits. Hex type. L.40mm met ofwel 10mm Hex ofwel 12mm Hex-aandrijving.

Order nr.	Orig. nr.	Type	Maat Hex mm	Aansluiting Hex	Prijs €
101860104 T	210705	Hex	5	10	2,81
101860203 T	210706	Hex	6	10	2,81
101860302 T	210707	Hex	7	10	2,81
101860401 T	210708	Hex	8	10	2,81
101860500 T	210709	Hex	9	10	2,81
101860609 T	210710	Hex	10	10	2,81
101860708 T	210712	Hex	12	12	3,05
101860807 T	210714	Hex	14	12	4,17
101860906 T	210717	Hex	17	12	6,00
101861003 T	210719	Hex	19	12	7,10

TENGITOOLS



Lange bits. Hex type. L.75mm met ofwel 10mm Hex ofwel 12mm Hex-aandrijving.

Order nr.	Orig. nr.	Type	Maat Hex mm	Aansluiting Hex	Prijs €
101880102 T	210805	Hex	5	10	4,17
101880201 T	210806	Hex	6	10	4,17
101880300 T	210807	Hex	7	10	4,17
101880409 T	210808	Hex	8	10	4,17
101880508 T	210809	Hex	9	10	4,17
101880607 T	210810	Hex	10	10	4,17
101880706 T	210812	Hex	12	12	4,39
101880805 T	210814	Hex	14	12	6,80
101880904 T	210817	Hex	17	12	9,70
101881001 T	210819	Hex	19	12	11,50

TENGITOOLS



Lange bits. Hex type. L.50mm met 1/4" Hex-aandrijving. VE = verpakkingseenheid.

Order nr.	Orig. nr.	Type	Maat Hex mm	VE	Prijs/VE €
106110109 T	HEX5000403	Hex	4	3	3,93
106110208 T	HEX5000503	Hex	5	3	3,93
106110307 T	HEX5000603	Hex	6	3	3,93
106110406 T	HEX5000803	Hex	8	3	6,20

TENGITOOLS



Bits. TX type. L.25mm met 1/4" Hex-aandrijving. VE = verpakkingseenheid.

Order nr.	Orig. nr.	Type	Maat TX	VE	Prijs/VE €
106120108 T	TX2500603	TX	6	3	4,25
106120207 T	TX2500703	TX	7	3	4,25
106120306 T	TX2500803	TX	8	3	4,25
106120405 T	TX2500903	TX	9	3	4,25
106120504 T	TX2501003	TX	10	3	4,25
106120603 T	TX2501503	TX	15	3	4,25
106120702 T	TX2502003	TX	20	3	4,25
106120801 T	TX2502503	TX	25	3	4,25
106120900 T	TX2502703	TX	27	3	4,25
106121007 T	TX2503003	TX	30	3	4,25
106121106 T	TX2504003	TX	40	3	4,25

TENGITOOLS



Bits. TX type. L.25mm met 1/4" Hex-aandrijving. VE = verpakkingseenheid.

Order nr.	Orig. nr.	Type	Maat TX	VE	Prijs/VE €
109690107 T	TX2501501B	TX	15	100	52,90
109690206 T	TX2502001B	TX	20	100	52,90
109690305 T	TX2502501B	TX	25	100	52,90
109690404 T	TX2503001B	TX	30	100	52,90
109690503 T	TX2504001B	TX	40	100	52,90

TENGOOLS



Lange bits. TX type. L.70mm met 1/4" Hex-aandrijving.

Order nr.	Orig. nr.	Type	Lengte mm	Maat TX	VE	Prijs/VE €
106130107	TX5000803	TX	50	8	3	6,40
106130206	TX5001003	TX	50	10	3	6,40
106130305	TX5001503	TX	50	15	3	6,40
106130404	TX5002003	TX	50	20	3	6,40
106130503	TX5002503	TX	50	25	3	6,40
106130602	TX5002703	TX	50	27	3	6,40
106130701	TX5003003	TX	50	30	3	6,40
106130800	TX7001002	TX	50	10	2	6,40
106130909	TX7001502	TX	70	15	2	6,40
106131006	TX7002002	TX	70	20	2	6,40
106131105	TX7002502	TX	70	25	2	6,40

TENGOOLS



Bits. TX type. L.40mm met ofwel 10mm Hex ofwel 12mm Hex-aandrijving.

Order nr.	Orig. nr.	Type	Maat TX	Aansluiting Hex	Prijs €
101870103	220720	TX	20	10	2,81
101870202	220725	TX	25	10	2,81
101870301	220727	TX	27	10	2,81
101870400	220730	TX	30	10	2,71
101870509	220740	TX	40	10	2,71
101870608	220745	TX	45	10	2,81
101870707	220750	TX	50	10	2,81
101870806	220755	TX	55	10	2,81
101870905	220760		60	12	3,27
101871002	220770	TX	70	12	4,50

TENGOOLS



Lange bits. TX type. L.75mm met ofwel 10mm Hex ofwel 12mm Hex-aandrijving.

Order nr.	Orig. nr.	Type	Maat TX	Aansluiting Hex	Prijs €
101890101	220820	TX	20	10	4,17
101890200	220825	TX	25	10	4,17
101890309	220827	TX	27	10	4,17
101890408	220830	TX	30	10	4,17
101890507	220840	TX	40	10	4,17
101890606	220845	TX	45	10	4,17
101890705	220850	TX	50	10	4,17
101890804	220855	TX	55	10	4,17
101890903	220860	TX	60	12	4,50
101891000	220870	TX	70	12	7,30

TENGOOLS



Bits. Rob - vierkant type. L.25mm met 1/4" Hex-aandrijving. VE = verpakkingseenheid.

Order nr.	Orig. nr.	Type	Maat Rob	VE	Prijs/VE €
106150105	ROB2500103	ROB	1	3	4,75
106150204	ROB2500203	ROB	2	3	4,75
106150303	ROB2500303	ROB	3	3	4,75

TENGOOLS



Bits. TPX type. L.25mm met 1/4" Hex-aandrijving. VE = verpakkingseenheid.

Order nr.	Orig. nr.	Type	Maat TPX	VE	Prijs/VE €
106140106	TPX2501003	TPX	10	3	5,50
106140205	TPX2501503	TPX	15	3	5,50
106140304	TPX2502003	TPX	20	3	5,50
106140403	TPX2502503	TPX	25	3	5,50
106140502	TPX2502703	TPX	27	3	5,50
106140601	TPX2503003	TPX	30	3	5,50
106140700	TPX2504003	TPX	40	3	5,50
106141005	TPX2501010	TPX	10	10	10,50
106141104	TPX2501510	TPX	15	10	10,50
106141203	TPX2502010	TPX	20	10	10,50
106141401	TPX2502710	TPX	27	10	10,50
106141500	TPX2503010	TPX	30	10	10,50
106141609	TPX2504010	TPX	40	10	10,50



METALWORKS



Haakse boorhouder. Met deze boorhouder boort u in de kleinste hoekjes. Geleverd met een zelfspannende boorhouder cap. 0-10mm. Boormachine zijde met 5/16" opname. Japans kwaliteitsproduct.

Order nr.	728540090	
Orig. nr.	PRO90	
Maximum koppel	Nm	53
Aansluiting boormachine	mm	8
Prijs	€	67,90

METALWORKS

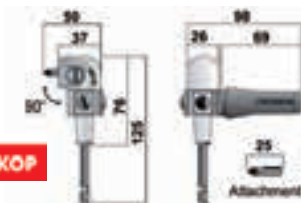

LED KORTE KOP

Haakse bitshouder. Met deze bitshouder bereikt u de meeste onmogelijke hoekjes. Voor alle gangbare bitsen met 1/4" hex-opname. Boormachine zijde eveneens 1/4" hex opname. Japans kwaliteitsproduct.

Order nr.	728541017	
Orig. nr.	PRO75+LED	
Maximum koppel	Nm	75
Prijs	€	80,50

METALWORKS



KORTE KOP



Haakse bitshouder. Met deze bitshouder bereikt u de meeste onmogelijke hoekjes. Voor alle gangbare bitsen met 1/4" hex-opname. Boormachine zijde eveneens 1/4" hex opname. Japans kwaliteitsproduct.

Order nr.	728541001	
Orig. nr.	PRO75	
Maximum koppel	Nm	75
Prijs	€	69,90

METALWORKS

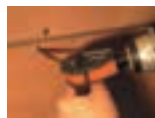

VERSTELBAAR

Haakse bitshouder. Met deze bitshouder bereikt u de meeste onmogelijke hoekjes. Voor alle gangbare bitsen met 1/4" hex-opname. Boormachine zijde eveneens 1/4" hex opname. Japans kwaliteitsproduct.

Order nr.	728540100	
Orig. nr.	PRO75F	
Maximum koppel	Nm	75
Prijs	€	77,90

Q lijn momentsleutels

Deze lijn momentsleutels is gemaakt voor de professionele gebruiker.

Met een laag eigengewicht en slanke uitvoering, is het mogelijk voor de gebruiker om de momentsleutel te gebruiken in kleine beperkte ruimtes.

- Nauwkeurigheid van $\pm 4\%$ conform aan alle internationale industriële momentsleutelstandaards.
- Bi-directioneel, dus geschikt voor zowel links als rechts gebruik, ergonomische handgreep met vastzet functie, draaiknop om de draairichting om te zetten, grote en duidelijke aflees unit voor aflezing in NM en LB/Ft, 60 tands ratelkop met quick release om de dop snel of simpel te kunnen verwisselen.
- Bij elke sleutel wordt een individueel testcertificaat meegeleverd.
- Wordt geleverd in een kunststof box.
- Geproduceerd volgens norm ISO6789:2003





Met de introductie van deze nieuwe serie Teng Tools momentsleutels heeft men een serie momentsleutels voor de professionele markt zowel in de automotive als ook in de industriële sector.

Als toevoeging aan het bestaande range met momentsleutels, schroevendraaiers en krachtvermeerderaars, is Teng Tools constant aan het verbeteren en uitbreiden in deze groeiende range van aandrijfmoment producten.

Momentsleutels





Momentsleutels

TENGOOLS



39-delige set bestaande uit 1 moment schroevendraaier 1/4", 1 verlengstuk L. 100mm, 1 bitshouder 1/4" en 36 verschillende bits.

Order nr.	122500101	
Orig. nr.	TTSD39	
Bitsen	Plat 0,5x3mm - Plat 0,6x4,5mm - Plat 0,8x5,5mm - Plat 1,2x6,5mm - PH0 - PH1 - PH2 - PH3 - PZ0 - PZ1 - PZ2 - PZ3 - TX8 - TX9 - TX10 - TX15 - TX20 - TX25 - TX27 - TX30 - TX40 - TPX10 - TPX15 - TPX20 - TPX30 - TPX40 - Rob 0 - Rob 1 - Rob 2 - Rob 3 - PH GR 2(2) - Hex 2mm - Hex 3mm - Hex 4mm - Hex 5mm - Hex 6mm	
Momentschroevendraaier 1/4" Hex voor	Nm	1-5
Prijs	€	96,90

TENGOOLS



Set van 1 momentschroevendraaier 1/4" Cap 1-5Nm en 1 bitshouder 1/4" - 1/4" hex.

Order nr.	122060106	
Orig. nr.	1492SD	
Bereik ISO	Nm	1-5
Doppen	inch	hex 1/4
Nauwkeurigheid	mm	+/-6%
Prijs	€	75,90

TENGOOLS



Momentschroevendraaier voor precisie aanspannen van moeren en bouten. Met 1/4" vierkante aansluiting en een adaptor voor 1/4" zeskante bitsen. Geschikt voor o.a. fijne mechanica, elektronica, ... Geleverd met een 1/4" T-handvat.

Order nr.	172300105	
Orig. nr.	1492SDA	
Bereik ISO	Nm	28
Bereik	lbs.in	20-70
Lengte	mm	160
Doppen	inch	hex 1/4
Nauwkeurigheid	mm	+/-6%
Prijs	€	73,90

TENGOOLS



22-delige set bestaande uit 1 momentsleutel 3/8", 10 opsteeksleutels, 8 bitsen TX, 1 bitshouder en 2 verlengstukken 3/8" L. 75 en 125mm. Geleverd in een Teng tray geschikt voor elke Teng gereedschapskoffer of -wagen. TTX-tray.

Order nr.	102110104	
Orig. nr.	TTX3892	
Aansluiting	inch	3/8
Bitsen TX		8 - 10 - 15 - 20 - 25 - 27 - 30 - 40
Verlengstukken 3/8"	mm	75 - 125
Opsteeksleutels	mm	10 - 11 - 12 - 13 - 14 - 15 - 16 - 17 - 18 - 19
Bereik	Nm	20-100
Afmetingen (l x b x h)	mm	570 x 110 x 60
Prijs	€	112,00

TENGOOLS



Set van 1 momentsleutel 1/2". 1292AG-EP. Richting omkeerbaar dmv hendel maar enkel rechtshandig voor instellen moment. TTX Tray.

Order nr.	73190100	
Orig. nr.	TTX1292	
Aansluiting	inch	1/2
Capaciteit	Nm	40-200
Prijs	€	70,90

TENGTTOOLS



TYPE STANDARD

STANDARD TYPE. Momentsleutel conform DIN3122. Voorzien van een ratelfunctie zodat de momentsleutel zowel voor aandraaien als final aanspannen kan worden gebruikt. Richting omkeerbaar dmv een hendel maar enkel rechtshandig voor instellen moment. Voorzien van een hoekinstelling-schaal voor na het aanspannen. Aanduiding in Nm en Lbs. Vergrendelbare instelling. Nauwkeurigheid van +/- 4%. Gesatineerde afwerking met rode coating.

Order nr.	Orig. nr.	Aansluiting inch	Bereik ISO Nm	Bereik lbs.in	Lengte mm	Prijs €
73190035	1492AGE	1/4	5-25	4-18	277	53,90
73190050	3892AG-E1	3/8	5-25	4-18	277	59,90
73190076	3892AG-E3	3/8	19-110	14-81	368	65,90
73190191	1292AG-EP	1/2	40-210	30-160	465	73,90
73190209	1292AGE-4	1/2	70-350	50-250	632	117,00
73190274	3492AG-E	3/4	90-450	67-340	850	184,00
73190308	3492AG-E1	3/4	140-700	100-500	1065	478,00
73190407	3492AG-E2	3/4	140-980	100-700	1213	499,00

TENGTTOOLS



TYPE STANDARD

STANDARD TYPE BI-DIRECTIONAL. Conform DIN3122. Geschikt voor linkse en rechtse werking dmv een push-through aandrijving. Voorzien van een ratelfunctie. Richting omkeerbaar dmv een hendel. Voorzien van een hoekinstelling-schaal voor na het aanspannen. Aanduiding in Nm en Lbs. Vergrendelbare instelling. Nauwkeurigheid van +/- 4%. Gesatineerde afwerking met rode coating.

Order nr.	Orig. nr.	Aansluiting inch	Bereik ISO Nm	Bereik lbs.in	Lengte mm	Prijs €
73190175	1292AG-ER	1/2	40-200	30-160	465	81,90
73190258	1292AG-E4R	1/2	70-350	50-250	632	122,00
73190282	3492AG-ER	3/4	65-450	45-300	850	163,00

TENGTTOOLS



Q-TYPE MINI

Q-TYPE MINI ANALOG DISPLAY. Conform DIN3122. Industriële kwaliteit voor de professioneel ! Deze nieuwe lijn Teng Tools momentsleutels is speciaal gemaakt voor de professionele veeleisende gebruiker. Een laag eigengewicht en een 'slanke' uitvoering laat de gebruiker toe om deze momentsleutel te gebruiken in kleine beperkte ruimtes. Voorzien van een ratelfunctie zodat de momentsleutel zowel voor aandraaien als final aanspannen kan worden gebruikt. Draaiknop in de ratelkop om de draairichting te wijzigen. Zeer eenvoudige instelling van het gewenste moment met vastzetfunctie op het handvatuiteinde. Quick release – eenvoudig verwijderen van de dopleutel. Duidelijke maataanduiding in Nm en Lbs. Nauwkeurigheid van +/- 4% conform alle internationale industriële momentsleutel-standaards. Twee-richting werkend (klikt zowel in wijzer- als in niet-wijzer richting).

Order nr.	Orig. nr.	Aansluiting inch	Bereik ISO Nm	Bereik lbs.in	Lengte mm	Prijs €
143870012	1492Q005	1/4	1-5	10-45	180	89,00
143870020	1492Q010	1/4	2-10	20-100	197	89,00
143870038	1492Q015	1/4	3-15	30-150	197	89,00
143870046	1492Q030	1/4	6-30	5-25	218	89,00
143870053	3892Q030	3/8	6-30	5-25	218	89,00

TENGTTOOLS



Q-TYPE ANALOG

Q-TYPE ANALOG DISPLAY. Conform DIN3122. Industriële kwaliteit voor de professioneel ! Deze nieuwe lijn Teng Tools momentsleutels is speciaal gemaakt voor de professionele veeleisende gebruiker. Een laag eigengewicht en een 'slanke' uitvoering laat de gebruiker toe om deze momentsleutel te gebruiken in kleine beperkte ruimtes. Voorzien van een ratelfunctie zodat de momentsleutel zowel voor aandraaien als finaal aanspannen kan worden gebruikt. Draaiknop in de ratelkop om de draairichting te wijzigen. Zeer eenvoudige instelling van het gewenste moment met vastzetfunctie op het handvatuiteinde. Quick release – eenvoudig verwijderen van de dopsleutel. Duidelijke maataanduiding in Nm en Lbs. Nauwkeurigheid van +/- 4% conform alle internationale industriële momentsleutel-standaards. Twee-richting werkend (klikt zowel in wijzer- als in niet-wijzer richting). Elke momentsleutel wordt geleverd met een individueel testcertificaat.

Order nr.	Orig. nr.	Aansluiting inch	Bereik ISO Nm	Bereik lbs.in	Lengte mm	Prijs €
143870061	3892Q060	3/8	10-60	10-50	400	104,00
143870087	3892Q100	3/8	20-100	20-70	400	114,00
143870103	1292Q200	1/2	40-200	30-150	483	134,00
143870202	1292Q320	1/2	50-320	50-230	550	134,00
143870301	3492Q500	3/4	100-500	80-500	788	266,00
143870400	3492Q1000	3/4	200-1000	200-700	1250	625,00

TENGTTOOLS



D-TYPE DIGITAL

D-TYPE DIGITAL DISPLAY. Gemakkelijk in gebruik. Mogelijkheid tot 9 vast ingestelde momenten. De tolerantie (%) kan ingesteld worden door de gebruiker (van 0 tot 9%). Audiovisuele verwittiging wanneer het moment bereikt wordt: oranje licht vóór het bereiken van het moment, groen licht op het moment, rood licht over het moment. Met heroproepbaar geheugen van de laatste 9 waarden. 3x standaard AA batterijen (niet meegeleverd). Geleverd in een rode doos. ISO 06789:2003. Geleverd met calibratie certificaat van fabriek.

Order nr.	Orig. nr.	Aansluiting inch	Bereik ISO Nm	Bereik lbs.in	Lengte mm	Prijs €
161810056	3892D100	3/8	10-100	7.75	457	254,00
161810106	1292D200	1/2	20-200	15-150	548	284,00

TENGTTOOLS



ACCESSOIRES

NEW

p.196

Momentsleutel met rechthoekige opname 9x12 of 14x18 mm. Eenvoudig afleesbare schaal in Nm en lbf.ft. Tolerantie 3%. Geleverd in een rode plastic doos. Conform ISO 06789. Geleverd met calibratie certificaat van fabriek.

Order nr.	Orig. nr.	Bereik ISO Nm	Lengte mm	Aansluiting mm	Bereik Nm	Schaal lbf.ft	Prijs €
186260105	TQWC100	20-100	491	9x12	20-70	1,0	137,00
186260204	TQWC200	40-200	545	14x18	30-150	2,0	144,00
186260303	TQWC500	100-500	824	14x18	80-500	5,0	299,00

TENGTOLS



Herstelkits voor herstelling van momentsleutels.

Order nr.	Orig. nr.	Aansluiting inch	Omschrijving	Prijs €
73191009	1492AGERK	1/4	repariit voor 1492AG-E	19,50
143870657	1492Q005RK	1/4	repariit voor 1492Q005	17,90
73191108	3892AGE1RK	3/8	repariit voor 3892AG-E1	19,50
73191207	3892AGE3RK	3/8	repariit voor 3892AG-E3	19,50
73191256	3892SPECRK	3/8	repariit voor 3892SPEC	23,90
143870756	3892Q030RK	3/8	repariit voor 3892Q030	21,50
143870806	3892Q060RK	3/8	repariit voor 3892Q060 en 3892Q100	10,50
73191405	1292AG4RK	1/2	repariit voor 1292AG-E4	22,90
73191702	1292AG4RRK	1/2	repariit voor 1292AG-E4R	28,50
73191306	1292AGERK	1/2	repariit voor 1292AG-E / 1292AG-ER / 1292AG-EP en 1292SPEC	22,90
73191603	1292AGERRK	1/2	repariit voor 1292AG-ER	21,00
143870905	1292Q200RK	1/2	repariit voor 1292Q200 en 1292Q320	21,50
73191504	3492AG1RK	3/4	repariit voor 3492AG-E1 en 3492AG-E2	66,90
73191801	3492AGERK	3/4	repariit voor 3492AG-E	48,50
73191900	3492AGERRK	3/4	repariit voor 3492AG-ER	60,50
166980954	3492Q500RK	3/4	repariit voor 3492Q500	46,50
143870954	3492Q500RK	3/4	repariit kit voor momentsleutel 3/4"	46,50

TENGTOLS



NEW

Preset momentsleutelset. Voor o.a. messing koppelingen in airconditioners. Accuraatheid +/- 4%.

Order nr.	186380101	
Orig. nr.	ACD01	
Vooraf ingestelde koppel	Nm	18 - 42 - 55 - 65
Maat steeksleutel	mm	17 - 22 - 26 - 29
Prijs	€	199,00

TENGTOLS

NEW



Accessoires voor momentsleutels. Ratels met rechthoekige opname 9x12 of 14x18 mm. Geschikt voor TQWC 100 (opname 9x2) of TQWC 200-500 (opname 14x18).

Order nr.	Orig. nr.	Aansluiting inch	Aansluiting mm	Prijs €
186280103	3892CQ100R	3/8	9x12	17,90
186280202	1292CQ200R	1/2	14x18	19,90
186280301	3492CQ500R	3/4	14x18	65,90

TENGTOLS

NEW



Accessoires voor momentsleutels. Opsteek-ringsleutels met rechthoekige aansluiting 9x12 of 14x18 mm.

Order nr.	Orig. nr.	Aansluiting mm	Maat mm	Prijs €
186310405	690710	9x12	10	12,90
186310504	690711	9x12	11	12,90
186310603	690712	9x12	12	12,90
186310702	690713	9x12	13	13,50
186310801	690714	9x12	14	13,50
186310900	690715	9x12	15	13,50
186311007	690716	9x12	16	13,50
186311106	690717	9x12	17	13,50
186311205	690718	9x12	18	14,50
186311304	690719	9x12	19	14,50
186311403	690813	14x18	13	14,50
186311502	690814	14x18	14	14,50
186311601	690815	14x18	15	14,50
186311700	690816	14x18	16	14,50
186311809	690817	14x18	17	15,50
186311908	690818	14x18	18	15,50
186312005	690819	14x18	19	15,50
186312104	690821	14x18	21	16,50
186312203	690822	14x18	22	16,50
186312302	690824	14x18	24	16,50
186312401	690826	14x18	26	16,90
186312500	690827	14x18	27	16,90
186312609	690829	14x18	29	16,90
186312708	690830	14x18	30	16,90
186312807	690832	14x18	32	16,90
186312906	690834	14x18	34	18,50
186313003	690836	14x18	36	18,50
186313102	690838	14x18	38	19,50
186313300	690841	14x18	41	22,50
186313409	690842	14x18	42	22,50
186313508	690844	14x18	44	25,90
186313607	690846	14x18	46	25,90

OUR TENG TOOLS MASTERS FRIENDS

JFB RACING TEAM



KURT OLIVIER & TOM FIEUW



FERDI PERNEEL & FILIP COLLEZ



FUN RIDERS



www.tengtoolsmasters.com

TENGTOOLS



NEW

Accessoires voor momentsleutels. Opsteeksteeksleutels met rechthoekige aansluiting 9x12 of 14x18 mm.

Order nr.	Orig. nr.	Aansluiting mm	Maat mm	Prijs €
186300406	690510	9x12	10	12,90
186300505	690511	9x12	11	12,90
186300604	690512	9x12	12	12,90
186300703	690513	9x12	13	13,50
186300802	690514	9x12	14	13,50
186300901	690515	9x12	15	13,50
186301008	690516	9x12	16	13,50
186301107	690517	9x12	17	13,50
186301206	690518	9x12	18	13,50
186301305	690519	9x12	19	13,50
186301404	690613	14x18	13	14,50
186301503	690614	14x18	14	14,50
186301602	690615	14x18	15	14,50
186301701	690616	14x18	16	14,50
186301800	690617	14x18	17	14,50
186301909	690618	14x18	18	14,50
186302006	690619	14x18	19	14,50
186302105	690621	14x18	21	14,50
186302204	690622	14x18	22	14,50
186302303	690624	14x18	24	15,50
186302402	690626	14x18	26	15,50
186302501	690627	14x18	27	15,50
186302600	690629	14x18	29	15,50
186302709	690630	14x18	30	15,50
186302808	690632	14x18	32	15,50
186302907	690634	14x18	34	16,90
186303004	690636	14x18	36	16,90
186303103	690638	14x18	38	17,90
186303202	690640	14x18	40	17,90
186303301	690641	14x18	41	21,50
186303400	690642	14x18	42	21,50
186303509	690644	14x18	44	23,50
186303608	690646	14x18	46	23,50

TENGTOOLS



NEW

TORQ02

TORQ03-04-05

Digitaal calibreertoestel voor momentsleutels. Precisie is +1% van de gemeten waarde. Geleverd met calibratiecertificaat (klokgevijs).

Order nr.	Orig. nr.	Aansluiting inch	Bereik lbf.ft	Bereik Nm	Prijs €
186540209	TORQ02	1/4, 3/8	1.10-22.0	1.5-30	725,00
186540308	TORQ03	1/4, 3/8	5.5-110	7.5-150	725,00
186540407	TORQ04	3/8, 1/2	18-370	25-500	725,00
186540506	TORQ05	1/2, 3/4	36-740	50-1000	779,00

Tangen

Bij het ontwikkelen van het nieuw gamma tangen hebben we rekening gehouden met de Europese markt en de wensen van de eindgebruiker. Het materiaal en het design werden verbeterd. Het gamma werd eveneens gecompleteerd. De nieuwe twee componenten handvaten geven niet enkel een goede grip; ze zien er ook fantastisch uit!

- Nieuw gelegeerd staal met CrMo voor een betere knip functie.
- Volledig gelijkvormig geslepen kopstuk.
- Nieuw dunner design volgens Europese stijl.





- Rubber/vinyl handvat in 1 kleur.
- Nieuw design voor de 2-componenten handvaten, in lijn met het nieuw Teng Tools design.
- Snijcapaciteit met lasermarkering aangeduid bij de kniplijn.





Tangen

TENGOOLS



Set van 8 tangen. Twee waterpomptangen (175 en 200), twee combinatietangen (150 en 200), twee zijknijptangen (150 en 200) en twee platbektang (150 en 200). Chroom-molybdeen staal. Ergonomisch twee componenten handvat. TTD tray.

Order nr.	174360107		
Orig. nr.	TTD441-T		
Afmetingen (l x b x h)	mm	280 x 280 x 50	
Prijs	€	112,00	

TENGOOLS



Set van 4 Mega Bite tangen bestaande uit 1 waterpomptang 250mm, 1 zijknijptang 150mm, 1 lange bektang 200mm en 1 combinatietang 175mm. Met zwart-rode vinyl-beklede anti-slip handvaten. TC-tray.

Order nr.	44280105		
Orig. nr.	TT440		
Prijs	€	62,90	

TENGOOLS



Set van 4 Mega Bite tangen bestaande uit 1 waterpomptang 250mm, 1 zijknijptang 150mm, 1 lange bektang 200mm en 1 combinatietang 175mm. Met een ergonomisch zwart-rood twee-componenten TPR-handvat. TC-tray.

Order nr.	109820101		
Orig. nr.	TT440-T		
Afmetingen (l x b x h)	mm	265 x 142 x 50	
Prijs	€	59,90	

TENGOOLS



Moeriertang-betonijzertang. DIN ISO 9242. Inductief nageharde bekken. Chroom vanadium staal. Zwart gefosfateerd met vinyl-bekleed handvaten.

Order nr.	177960101	177960200	177960309
Orig. nr.	MB449-9	MB449-10	MB449-11
Lengte	mm 230	250	280
Capaciteit staaldraad	mm 1,8	2,0	2,5
Capaciteit ijzerdraad	mm 2,0	2,2	3,0
Capaciteit koperdraad	mm 3,4	3,8	4,0
Prijs	€ 20,90	23,50	23,90

TENGOOLS



Nijptang met snijhoek 85°.

Order nr.	185930104	185930203
Orig. nr.	MB489-7	MB489-8
Lengte	mm 180	200
Capaciteit in staal	mm 1,6	1,8
Capaciteit in ijzer	mm 2,0	2,0
Prijs	€ 20,90	26,50

TENGOOLS



Snijknijptang voor kunststof. Geschikt voor kunststof en zacht materiaal zoals lood en tin. Gepolijste afwerking. Met veer. Vinyl bekleed handvat.

Order nr.	177940103	177940202	177940301
Orig. nr.	MB541-5	MB541-6	MB541-7
Lengte	mm 125	150	180
Prijs	€ 19,90	21,50	26,50

TENGOOLS



Zijknijptang. Voor middelharde en harde draad. Zweeds model. Met vinyl-bekleed handvat.

Order nr.	Orig. nr.	Lengte	Capaciteit piano-draad	Capaciteit staaldraad	Capaciteit ijzer-draad	Capaciteit koper-draad	Prijs
		mm	mm	mm	mm	mm	€
74210154	MB441-5	135	1,5	1,8	2,3	4,0	14,90
74210105	MB441-6	155	1,6	2,0	2,5	4,0	16,50
74210147	MB442-5	140	1,6	2,0	4,0	4,0	16,00
74210170	MB442-6	160	2,0	2,5	2,5	4,0	16,50
74210196	MB442-7	180	2,0	2,5	4,0	4,2	19,50
74210204	MB442-8	200	2,5	4,0	4,0	4,2	20,50

TENGOOLS



Zijkniptang. Voor middelharde en harde draad. Zweeds model. Ergonomisch twee-componenten TPR-handvat.

Order nr.	109740100	109740209
Orig. nr.	MB441-5T	MB441-6T
Lengte	mm 135	155
Capaciteit pianodraad	mm 1,5	1,6
Capaciteit staaldraad	mm 4,8	2,0
Prijs	€ 16,50	16,50

TENGOOLS



Extra-zwarte zijkniptang. Voor harde staaldraad. Amerikaans model. Ergonomisch twee-componenten TPR-handvat.

Order nr.	109750109	109750208
Orig. nr.	MB442-6T	MB442-8T
Lengte	mm 160	200
Capaciteit pianodraad	mm 2	2,5
Capaciteit staaldraad	mm 2,5	3,0
Capaciteit ijzerdraad	mm 3,8	4,0
Prijs	€ 17,90	19,50

TENGOOLS



Zijkniptang met veer, voor staaldraad, ijzerdraad en koperdraad. Chroom molybdenum staal. Vinyl beklede handvatten. DIN 5749.

Order nr.	178390100
Orig. nr.	MB442-7S
Lengte	mm 180
Capaciteit pianodraad	mm 2,0
Capaciteit staaldraad	mm 2,5
Capaciteit ijzerdraad	mm 4,0
Capaciteit koperdraad	mm 4,2
Prijs	€ 23,00

TENGOOLS



Extra-zwarte zijkniptang met gebogen kop 15°. Voor harde staaldraad. Amerikaans model. Ergonomisch twee-componenten TPR-handvat.

Order nr.	109750307
Orig. nr.	MB442B-8T
Lengte	mm 200
Capaciteit pianodraad	mm 2,5
Capaciteit staaldraad	mm 3
Capaciteit ijzerdraad	mm 4,0
Prijs	€ 23,50

TENGOOLS



Kopkniptang.

Order nr.	99960155	99960171
Orig. nr.	MB448-6	MB448-8
Lengte	mm 160	200
Capaciteit staaldraad	mm 1,6	1,6
Capaciteit ijzerdraad	mm 1,8	1,8
Capaciteit koperdraad	mm 3,4	3,4
Prijs	€ 20,90	26,50

TENGOOLS



Kabelkniptang. Chroom molybdenum staal. Voor koperen en aluminium kabels. Twee snijposities. Kan met een hand gebruikt worden. Vinyl bekleed handvat.

Order nr.	116760059	116760158	116760208
Orig. nr.	MB444-6	MB444-8	MB444-10
Lengte	mm 160	200	250
Capaciteit koperdraad	mm ² 22	38	60
Prijs	€ 19,90	24,50	32,50

TENGOOLS



Kabelkniptang. Professionele kwaliteit. Met titanium gecoat scharnier. Voor koper- en aluminiumkabels. Ergonomisch twee-componenten TPR-handvat.

Order nr.	109760108
Orig. nr.	MB444-8T
Lengte	mm 200
Capaciteit koperdraad	mm 38
Prijs	€ 21,90

TENGOOLS



Extra-zware kabelkniptang. Chroom molybdenum staal. Voor koperen en aluminium elektrische kabels. Kan met een hand gebruikt worden. Vinyl bekleed handvat.

Order nr.	116760307
Orig. nr.	MB445-10
Lengte	mm 250
Koperen draad	mm ² 60
Prijs	€ 34,50

TENGOOLS



Kabelknipper. Matrijsgesmeed. De chroom molydenium staal bladen zijn gehard om kanten te knippen. Knipt koper en aluminium elektrische kabels tot 2AWG (14 mm²) diameter HRC 60-62.

Order nr.	144050101		
Orig. nr.	496		
Lengte	mm	250	
Snijcapaciteit	mm	12	
Maximum kabelgrootte	mm ²	14 (2AWG)	
Prijs	€	23,90	

TENGOOLS



NEW

Staaldradschaar met terugspringveer.

Order nr.	86970100		
Orig. nr.	498-7		
Lengte	mm	190	
Capaciteit pianodraad	mm	2,5	
Capaciteit staaldraad	mm	7	
Capaciteit roestvrij staal	mm	4	
Prijs	€	39,90	

TENGOOLS



Combinatietang. Met vinyl-bekleed handvat.

Order nr.	74190075	74190083
Orig. nr.	MB451-7	MB451-8
Lengte	mm 175	200
Capaciteit pianodraad	mm 1,8	2
Capaciteit staaldraad	mm 2	2,2
Prijs	€ 17,50	20,50

TENGOOLS



Zware combinatietang. Chroom molybdenum staal. Vinyl beklede handvatten. DIN 5746.

Order nr.	Orig. nr.	Lengte	Capaciteit pianodraad	Capaciteit staaldraad	Capaciteit ijzerdraad	Prijs
		mm	mm	mm	mm	€
74190026	MB452-6	160	1,6	1,8	3,4	16,50
74190059	MB452-7	180	1,8	2,0	3,8	19,50
74190109	MB452-8	200	2,0	2,2	4,0	22,90
74190307	MB452-9	225	2,0	2,2	4,0	25,50

TENGOOLS



Combinatietang. Ergonomisch twee-componenten TPR-handvat. DIN5746.

Order nr.	109770107	109770206	109770305
Orig. nr.	MB452-6T	MB452-7T	MB452-8T
Lengte	mm 160	180	200
Capaciteit pianodraad	mm 1,6	1,8	2
Capaciteit staaldraad	mm 1,8	2,0	2,2
Capaciteit ijzerdraad	mm 3,4	3,8	4,0
Prijs	€ 20,90	19,90	21,50

TENGOOLS



Lange rechte bektang. Met vinyl-bekleed handvat. MB463-8 met bek 45° gebogen. DIN5746.

Order nr.	Orig. nr.	Lengte mm	Neuslengte mm	Prijs €
74230038	MB461-5	140	50	14,50
74230053	MB461-6	160	55	16,50
74230103	MB461-8	200	65	20,50
74230152	MB463-5	140	50	16,50
74230178	MB463-6	160	55	18,50
74230202	MB463-8	200	65	20,50

TENGOOLS



Lange rechte bektang. Ergonomisch twee-componenten TPR-handvat. DIN5746.

Order nr.	109780106	109780205
Orig. nr.	MB461-6T	MB461-8T
Lengte	mm 150	200
Neuslengte	mm 55	65
Prijs	€ 16,50	19,50

TENGOOLS



Lange gebogen bektang. Bek, 45° hoek. Ergonomisch twee-componenten TPR-handvat. DIN5746.

Order nr.	109790105	
Orig. nr.	MB463-8T	
Lengte	mm 200	
Neuslengte	mm 65	
Prijs	€ 19,50	

TENGOOLS



Telefoontang. Chroom molybdenum staal. Gepolijste kop. Gekartelde gripoppervlak. Vinyl-bekleed handvat. DIN 5745.

Order nr.	116770158	
Orig. nr.	MB464-6	
Lengte	mm	165
Beklengte	mm	55
Prijs	€	15,50

TENGOOLS



Telefoontang. Lang recht beken. Chroom molybdenum staal. Gepolijste kop. Gekartelde gripoppervlak. Ergonomisch twee-componenten TPR-handvat. DIN 5745.

Order nr.	109800102	
Orig. nr.	MB464-6T	
Lengte	mm	165
Neuslengte	mm	55
Prijs	€	17,90

TENGOOLS



Lange ronde bektang. Chroom molybdenum staal. Gepolijste afwerking. Met veer. Gladde tips. Vinyl bekleed handvat.

Order nr.	177950052	
Orig. nr.	MB465-6	
Lengte	mm	150
Beklengte	mm	45
Prijs	€	16,50

TENGOOLS



Naald bektang. Staal met hoog koolstofgehalte. Handvatten met veer. Vinyl beklede handvatten.

Order nr.	177950201	177950300
Orig. nr.	MBM468	MBM469
Lengte	mm	150
Neuslengte	mm	35
Type	recht	gebogen
Prijs	€	18,50

TENGOOLS



Ronde bektang geschikt voor electronica. Staal met hoog koolstofgehalte. Handvatten met veer. Vinyl beklede handvatten.

Order nr.	177950102	
Orig. nr.	MBM467	
Lengte	mm	125
Neuslengte	mm	18
Prijs	€	18,50

TENGOOLS



MBM 441



MBM 449



MBM 464



MBM 461

Mini-tangen. Mini-zijkniptang. Mini-kopkniptang. Mini-lange rechte bektang. Mini-telefoontang.

Order nr.	Orig. nr.	Lengte mm	Prijs €
99960106	MBM441	110	14,90
99960205	MBM449	110	17,90
99960304	MBM461	125	17,90
99960502	MBM464	125	17,90

TENGOOLS



Universele waterpomptang. DIN 8976 Type C. Met 7 verstelposities. Chroom vanadium staal. Met vinyl-bekleed handvat.

Order nr.	74170051	74170101
Orig. nr.	MB481-7	MB481-10
Lengte	mm	180
Capaciteit	mm	3-25
Prijs	€	16,90

TENGOOLS



Universele waterpomptang. DIN 8976 Type C. Met 7 verstelposities. Chroom vanadium staal. Ergonomisch twee-componenten TPR-handvat.

Order nr.	109420109	109420208
Orig. nr.	MB481-7T	MB481-10T
Lengte	mm 180	250
Capaciteit	mm 3-25	3-38
Prijs	€ 17,50	20,90

TENGOOLS

NEW



Waterpomptang met handig kliksysteem. Chroom vanadium staal. Met vinyl-bekleed handvat.

Order nr.	186230207	186230108
Orig. nr.	MB481-10TQ	MB481-10Q
Lengte	mm 250	250
Capaciteit	mm 3-38	3-38
Prijs	€ 29,50	28,50

TENGOOLS



Universele waterpomptang. DIN 8976 Type A. Zware-uitvoering. Met verstelbaar scharnier met groeven. Chroom vanadium staal. Met vinyl-bekleed handvat.

Order nr.	105930051	105930077	105930101
Orig. nr.	MB410	MB412	MB416
Lengte	mm 250	300	400
Capaciteit	mm 45	60	90
Prijs	€ 23,90	30,00	48,50

TENGOOLS



Ontmanteltang. Met veer en vastzetschroef. Voor draad met capaciteit van 0.2 tot 4.5mm. Ergonomisch twee-componenten TPR-handvat.

Order nr.	08700106
Orig. nr.	MB499-7T
Lengte	mm 155
Voor draaddiameter	mm 0,2-4,5
Prijs	€ 17,90

Tangen 1000V

TENGOOLS



Set van 4 geïsoleerde 1000V tangen klasse EN 60900 bestaande uit 1 zijknijptang, 1 lange bektang, 1 kabelstriiptang en 1 combinatietang. Geïsoleerde kunststof handgrepen. TC-tray.

Order nr.	117490102
Orig. nr.	TTV440
Zijknijptang	mm 150
Combinatie tangen	mm 175
Lange bektang	mm 200
Ontmanteltang	mm 175
Prijs	€ 65,90

TENGOOLS



18-delige 1000V-set bestaande uit 13 schroevendraaiers en 5 tangen.

Order nr.	178700100
Orig. nr.	TV18N
Aantal stuks	18
Combinatietangen	mm 200
Platte bektangen	mm 200
Striptangen	mm 180
Zijknijptangen	mm 150-200
Platte schroevendraaiers	mm 2,5 - 3,0 - 4,0 - 5,5 - 6,5
Schroevendraaiers PH	0 - 1 - 2 - 3
Schroevendraaiers PZ	0 - 1 - 2 - 3
Prijs	€ 196,00

TENGOOLS



Zware zijknijptang 1000V - EN/DIN 60 900. Voor harde staaldraad. Amerikaans model. Ergonomisch twee-componenten TPR-handvat.

Order nr.	117580100
Orig. nr.	MBV441-6
Lengte	mm 150
Capaciteit pianodraad	mm 1,6
Prijs	€ 20,50

TENGOOLS



Extra-zware zijknijptang 1000V. EN/DIN 60 900. Voor harde staaddraad. Amerikaans model. Ergonomisch twee-componenten TPR-handvat.

Order nr.	117590109	
Orig. nr.	MBV442-8	
Lengte	mm	200
Capaciteit pianodraad	mm	2,5
Prijs	€	26,50

TENGOOLS



Combinatietang 1000V - EN/DIN 60 900. Ergonomisch twee-componenten TPR-handvat.

Order nr.	117610105	117610204
Orig. nr.	MBV451-7	MBV451-8
Lengte	mm	175
Capaciteit pianodraad	mm	1,8
Prijs	€	26,50
		29,50

TENGOOLS



Lange rechte bektang 1000V - EN/DIN 60 900. Ergonomisch twee-componenten TPR-handvat.

Order nr.	117620104	
Orig. nr.	MBV461-8	
Lengte	mm	200
Neuslengte	mm	65
Prijs	€	25,90

TENGOOLS



Ontmanteltang 1000V - EN/DIN 60 900. Met veer en vastzetschroef. Voor draad met capaciteit van 0.2 tot 4.5mm. Ergonomisch twee-componenten TPR-handvat.

Order nr.	117630103	
Orig. nr.	MBV499-7	
Lengte	mm	155
Voor draaddiameter	mm	0,2-4,5
Prijs	€	22,50

Circlipstangen

TENGOOLS



Set van 4 circlipstangen L.125mm bestaande uit 1 recht inwendig, 1 recht uitwendig, 1 gebogen inwendig en 1 gebogen uitwendig model. TC-tray.

Order nr.	112520101	
Orig. nr.	TT474-5	
Circlips tangen	mm	Recht inwendig 10x25 - Gebogen inwendig 10x25 - Recht uitwendig 10x25 - Gebogen uitwendig 10x25
Prijs	€	41,50

TENGOOLS



Set van 4 circlipstangen L.175mm bestaande uit 1 recht inwendig, 1 recht uitwendig, 1 gebogen inwendig en 1 gebogen uitwendig model. TC-tray.

Order nr.	04030102	
Orig. nr.	TT474-7	
Circlips tangen	mm	recht inwendig 12x65mm - gebogen inwendig 12x65 - recht uitwendig 12x65mm - gebogen uitwendig 12x65mm
Prijs	€	47,90

TENGOOLS



Set van 4 circlipstangen L.225mm. TTX-tray.

Order nr.	112700109	
Orig. nr.	TTX474-9	
Tangen circlips recht inwendig	mm	32x80
Tangen circlips gebogen inwendig	mm	32x80
Tangen circlips recht uitwendig	mm	32x80
Tangen circlips gebogen uitwendig	mm	32x80
Afmetingen (l x b x h)	mm	265 x 142 x 50
Prijs	€	72,00

TENGOOLS



Rechte en gebogen circlipstangen voor inwendige circlipsen.

Order nr.	Orig. nr.	Lengte mm	Type mm	Voor circlips SgH mm	Prijs €
34960054	MB470-5	125	recht	10-25	15,50
34960104	MB470-7	175	recht	12-65	16,50
34960153	MB470-9	225	recht	32-80	26,50
34960179	MB471-5	125	gebogen	10-25	15,50
34960203	MB471-7	175	gebogen	12-65	17,00
34960302	MB471-9	225	gebogen	32-80	26,50

TENGOOLS



Rechte en gebogen circlipstangen voor uitwendige circlipsen.

Order nr.	Orig. nr.	Lengte mm	Type mm	Voor circlips SgH mm	Prijs €
35020056	MB472-5	125	recht	10-25	14,50
35020106	MB472-7	175	recht	10-40	16,50
35020155	MB472-9	225	recht	32-80	26,50
35020171	MB473-5	125	gebogen	10-25	14,50
35020205	MB473-7	175	gebogen	10-40	19,00
35020304	MB473-9	225	gebogen	32-80	26,50

TENGOOLS



Universele circlipstang met 4 verwisselbare koppen die 8 verschillende combinaties mogelijk maken. Zowel voor inwendige als uitwendige circlipsen. De tips zijn licht magnetisch. Met terugveer. Met vinyl-bekleed handvat.

Order nr.	74150103			
Orig. nr.	480			
Lengte	mm	150		
Voor circlips	mm	10-50		
Prijs	€	17,90		

Griptangen

TENGOOLS



Set van 5 griptangen bestaande uit 3 ronde bek en 2 lange bek. TC-tray.

Order nr.	122480106	
Orig. nr.	TTVG05	
Klassieke griptangen	mm	100 - 175 - 250
Griptangen lange dunne bekken	mm	100 - 150
Prijs	€	55,00

TENGOOLS



Set van 4 griptangen bestaande uit 1 C-bek 250mm (type 406), 1 platte bek 200mm (type 408), 1 gebogen bek 225mm (type 407) en 1 lange bek type 160mm (type 404). Geleverd in een PVC tray. PS-tray.

Order nr.	106230105	
Orig. nr.	TTSPG	
Prijs	€	55,90

TENGOOLS



Set van 2 griptangen bestaande uit de klassieke griptang 401-10 en de griptang 404-6 met lang dun bekken. Beide met knipfunctie.

Order nr.	116780107	
Orig. nr.	402	
Prijs	€	29,90

TENGOOLS



Klassieke griptang met gekartelde gebogen bekken. Met knipfunctie.

Order nr.	Orig. nr.	Lengte mm	Afmetingen mm	Prijs €
74250036	401-4	100	0-25	13,50
74250044	401-5	125	0-28	14,50
74250051	401-7	175	0-38	14,50
74250101	401-10	250	0-47	16,00
74250200	401-12	300	0-50	23,00



TENGOOLS



Klassieke griptang met gekarteld plat bekken.

Order nr.	101920106	101920205
Orig. nr.	401-10F	401-12F
Lengte	mm 250	300
Afmetingen	mm 0-45	0-52
Prijs	€ 18,50	24,50

TENGOOLS



Griptang met lang dun bekken. Met knipfunctie.

Order nr.	74270059	74270109	74270208
Orig. nr.	404-4	404-6	404-9
Lengte	mm 100	160	230
Bekbreedte	mm 2	6	9
Beklengte	mm 35	35	70
Prijs	€ 13,50	13,50	19,50

TENGOOLS



Griptang lange bek. Met extra smalle kaken en pijpgrip. Zelfsluitend en éénhandsmechanisme voor eenvoudige bediening. De moer op de instelknop vergemakkelijkt herhalingstaken. Vernikkeld.

Order nr.	186640306
Orig. nr.	404-6S
Lengte	mm 160
Bekbreedte	mm 6
Beklengte	mm 35
Prijs	€ 14,90

TENGOOLS



Griptang met C-vormige bekken.

Order nr.	101930105
Orig. nr.	406
Lengte	mm 250
Diepte uitlading	mm 70
Hoogte uitlading	mm 100
Afmetingen	mm 0-80
Prijs	€ 24,50

TENGOOLS



Griptang met C-vormig bekken met beweegbare bekkentips. Zelfsluitend en éénhandsmechanisme voor eenvoudige bediening. De moer op de instelknop vergemakkelijkt herhalingstaken. Vernikkeld.

Order nr.	186650305	186650602
Orig. nr.	406-6SP	406SP
Lengte	mm 172	285
Bekbreedte	mm 0-50	0-80
Diepte uitlading	mm 40	70
Hoogte uitlading	mm 60	100
Prijs	€ 23,90	31,90

TENGOOLS



Griptang met C-vormige bekken.

Order nr.	186650206
Orig. nr.	406-6
Lengte	mm 172
Bekbreedte	mm 0-50
Diepte uitlading	mm 40
Hoogte uitlading	mm 60
Prijs	€ 18,40

TENGOOLS



Griptang met C-vormig bekken met beweegbare bekkentips.

Order nr.	128300100
Orig. nr.	406P
Lengte	mm 275
Bekbreedte	mm 80
Prijs	€ 30,90

TENGOOLS



Griptang met C-vormig bekken. Zelfsluitend en éénhandsmechanisme voor eenvoudige bediening. De moer op de instelknop vergemakkelijkt herhalingstaken. Vernikkeld.

Order nr.	186650503	186650404
Orig. nr.	406S	406-6S
Lengte	mm 285	172
Bekbreedte	mm 0-80	0-50
Diepte uitlading	mm 70	40
Hoogte uitlading	mm 100	60
Prijs	€ 23,50	18,40

TENGOOLS

NEW



Griptang met C-vormig bekken. Met beweegbare bekkentips.

Order nr. 186650107 **T**

Orig. nr.		406-6P
Lengte	mm	172
Bekwijdte	mm	0-50
Diepte uitlading	mm	40
Hoogte uitlading	mm	60

Prijs € 22,90

TENGOOLS



Griptang met lange C-vormig bekken met beweegbare bekkentips.

Order nr. 128310109 **T**

Orig. nr.		409P
Lengte	mm	300
Bekbreedte	mm	65

Prijs € 26,90

TENGOOLS

NEW



Griptang 88mm C-type. Met beweegbare bekkentips. Zelfsluitend en éénhandsmechanisme voor eenvoudige bediening. De moer op de instelknop vergemakkelijkt herhalingsstaken. Vernikkeld.

Order nr. 186640207 **T**

Orig. nr.		409SP
Lengte	mm	300
Bekbreedte	mm	0-88

Prijs € 28,00

TENGOOLS



Grip-tafelklemtang met bek met aanpasbare tip. Montage op de klemtafel gebeurt door vastzetten van de tang op de tafel door vvb gleufbouten. (niet meegeleverd).

Order nr. 128320108 **T**

Orig. nr.		410P
Lengte	mm	230
Bekbreedte	mm	65

Prijs € 27,50

TENGOOLS

NEW



Griptang met Slot. Zelfsluitend en éénhandsmechanisme voor eenvoudige bediening. De moer op de instelknop vergemakkelijkt herhalingsstaken. Vernikkeld.

Order nr. 186640108 **T**

Orig. nr.		410SP
Lengte	mm	230
Diepte uitlading	mm	4,0
Hoogte uitlading	mm	65

Prijs € 31,50

TENGOOLS



Griptang voor de lasser. Met dubbele bekken.

Order nr. 101940104 **T**

Orig. nr.		407
Lengte	mm	225
Afmetingen	mm	0-65

Prijs € 20,50

TENGOOLS

NEW



Griptang 270mm voor lassen cap. 90mm. Zelfsluitend en éénhandsmechanisme voor eenvoudige bediening. De moer op de instelknop vergemakkelijkt herhalingsstaken. Vernikkeld.

Order nr. 186640405 **T**

Orig. nr.		407AS
Lengte	mm	270
Bekbreedte	mm	85
Diepte uitlading	mm	0-90

Prijs € 27,90

TENGOOLS



Griptang met 2 stevige wijde platte bekken.

Order nr. 101950103 **T**

Orig. nr.		408
Lengte	mm	200
Bekwijdte	mm	75
Afmetingen	mm	0-42

Prijs € 21,50

TENGOOLS



NEW

Buizensnijder 19-83mm. Om dunwandige roestvrij staal, koper en PVC-buizen te snijden, tot een dikte van 1.5mm. Zelfsluitend en met éénhandsbediening. De instelmoer zorgt ervoor dat de buizensnijder gemakkelijk kan gebruikt worden voor herhalingsartikelen. 15 snijwielen.

Order nr. 186770103 **T**

Orig. nr.		TF300
Buizensnijder	mm	19-83

Prijs € 55,00

Spanvijzen

TENGTOOLS



Spanvijs. Volledig in gehard staal. L-vorm in 1 stuk. Met T-vormige hendel (foto is Teng Tools model).

Order nr.	Orig. nr.	Maat mm	Klem- kracht kg	Afmetingen rail mm	Prijs €
128360104	CMF16	160x80	250	16,5x7,5	20,90
128360203	CMF20	200x100	400	19,5x9,5	28,50
128360302	CMF25	250x120	550	22x10,5	33,50
128360401	CMF30	300x140	650	25x12	41,90
128360500	CMF35	300x120	750	25x12	45,50
722174000	EHG40CS	400x175	700	27x13	48,50
722175000	EHS50CS	500x120	750	27x13	46,50
722176000	EHG60CS	600x175	700	27x13	52,90

TENGTOOLS



Spanvijs. Volledig in gehard staal. L-vorm in 1 stuk. Met 90° knikbare hendel (foto is Teng Tools model).

Order nr.	Orig. nr.	Maat mm	Klemkracht kg	Afmetingen rail mm	Prijs €
128370103	CMF16T	160x80	250	16,5x7,5	24,90
128370202	CMF20T	200x100	400	19,5x9,5	33,50
128370301	CMF25T	250x120	550	22x10,5	38,50
128370400	CMF30T	300x140	650	25,0x12,0	51,00
128370509	CMF35T	300x100	400	25,0x12,0	40,50
722184000	EHREG40C	400x175	700	25x12	54,00
722184010	EHREG40C	400x120	750	25x12	27,00
722186000	EHREG60C	600x175	700	25x12	54,00
722186010	EHREG60C	600x120	750	25x12	41,50

TENGTOOLS



Spanvijs. Volledig in gehard staal. L-vorm in 1 stuk. Met snelspanhendel. Ideaal waar een snelle klemming noodzakelijk is.

Order nr.	Orig. nr.	Maat mm	Klemkracht kg	Afmetingen rail mm	Prijs €
722161600	EHG16L	160x80	230	16x7,5	34,90
722162001	EHG20L	200x100	350	19,5x9,5	45,00
722163001	EHG30L	300x140	500	25x12	58,50
722164001	EHG40L	400x120	550	25x12	64,50
722165000	EHG50L	500x120	550	25x12	73,50
722166001	EHG60L	600x120	550	25x12	65,50

TENGTOOLS



Eenhands-spanklem. Met snelspansluiting. Stalen trekbaar. Spanstukken bekleed met kunststof bekleding. De vaste klauw is omkeerbaar voor inwendige klemming en uitwaartse duwen.

Order nr.	Orig. nr.	Maat mm	Klemkracht kg	Prijs €
208570101	208570101	150x85	150	16,00
208570200	208570200	300x85	150	20,50
208570309	208570309	450x85	150	21,50
208570408	208570408	600x85	150	23,00

Kabelschoentangen

METALWORKS



299-delig assortiment van de meest gangbare geïsoleerde kabelschoeenen. DTC tray TTD02.

Order nr.	161800310 ⓘ
Orig. nr.	TTD02T299
Prijs	€ 26,50

TENGOOLS



121-delige set bestaande uit 1 kabelschoentang CP50 voor geïsoleerde kabelschoeentjes (rode, blauwe en gele) en een assortiment van 120 kabelschoeentjes. TC-tray.

Order nr.	110380102 ⓘ
Orig. nr.	TTCP121
Prijs	€ 26,50

TENGOOLS



4-delige set bestaande uit 1 automatische kabelschoentang met 3 klauwen voor respectievelijk geïsoleerde 22-10 AWG, niet-geïsoleerde 22-12 AWG en niet-geïsoleerde 22-8 AWG kabelschoeenen. TC-tray.

Order nr.	122470107 ⓘ
Orig. nr.	TTCP04
Voor geïsoleerde kabelschoeenen	mm 22-10 AWG (0,324 mm ² - 5,261 mm ²)
Voor niet geïsoleerde ADENER-hulzen	mm 22-12 AWG (0,324 mm ² - 3,31 mm ²)
Voor niet-geïsoleerde kabelschoeenen	mm 22-8 AWG (0,3 mm ² - 8 mm ²)
Prijs	€ 61,50

METALWORKS



Set bestaande uit krimptang met een universele snelkoppeling met 6 verwisselbare klauwensets. Stalen tang met kwalitatieve krimpklaauwen in AISI 4140 materiaal. Gehard HRC 38-45. Beide handvaten van de tang zijn in een 2-component materiaal PP+TPR voor een aangename en goeie grip.

Order nr.	100071907 ⓘ
Orig. nr.	VES1907
Lengte krimptang	mm 220
Capaciteit geïsoleerde kabelschoeenen	AWG 22-18 - 16-14 - 12-10
Capaciteit niet-geïsoleerde kabelschoeenen	AWG 20-18 - 16-14 - 12-10 - 8
Capaciteit kleine ADENER-hulzen	AWG 22-20-18-16-14-12
Capaciteit grote ADENER-hulzen	AWG 10-8-6
Capaciteit coaxiale (BNC) koppelingen	mm 6,48-5,41-2,50-1,72-0,823
Prijs	€ 85,50

METALWORKS



Universele ontmantel- en krimptang. Geschikt voor geïsoleerde en niet-geïsoleerde kabelschoeentjes. Met knipfunctie. Met vinylbekleed handvat.

Order nr.	100071090 ⓘ
Orig. nr.	VES1090
Lengte	mm 225
Capaciteit	mm 0,5 - 0,75 - 1 - 1,5 - 2,5 - 4 - 6
Prijs	€ 9,50

TENGOOLS



Universele ontmantel- en krimptang. Geschikt voor geïsoleerde en niet-geïsoleerde kabelschoeentjes. Met knipfunctie. Met vinylbekleed handvat.

Order nr.	58340209 ⓘ	58340308 ⓘ
Orig. nr.	CP50	CP51
Voor geïsoleerde kabelschoeenen	mm 0,75 - 6	0,75 - 6
Lengte	mm 225	225
Ontmantelrand voor geleidingsdraad	mm ² 0,75 - 1 - 1,5 - 2,5 - 4 - 6	0,75 - 1 - 1,5 - 2,5 - 4 - 6
Voor snijden van bouten	mm 2,5 - 3 - 3,5 - 4 - 5	2,5 - 3 - 3,5 - 4 - 5
Voor uiteinden	mm rood - blauw - geel	rood - blauw - geel
Voor niet geïsoleerde kabelschoeenen	mm 1,5 - 2,5 - 4 - 6	0,5 - 1,5 - 2,5
Prijs	€ 21,50	21,50

TENGOOLS



Automatische krimp tang met kabelstrip -en knipfunctie. Met terugspringveer en sluihandel.

Order nr.	186820106 ⓘ		
Orig. nr.	mm	CP53	
Lengte	mm	180	
Capaciteit	AWG	20-8	
Capaciteit knipfunctie CU/AL	mm	1.0	
Capaciteit	mm	0.8 1 1.3 1.4 2 2.6 3.2	
Prijs	€	21,50	

METALWORKS



Easy stripper tang. 1 tang - 3 functies : kniptang, ontmanteltang en kabelschroentang. Met kunststof bekleed handvat.

Order nr.	100073500 ⓘ		
Orig. nr.	mm	VES3500	
Lengte	mm	210	
Prijs	€	16,50	

TENGOOLS



NEW

Ontmanteltang. Voor snel en eenvoudig ontmantelen van kabels van 0,2 tot 6 mm². Snijdt kabels tot 2 mm.

Order nr.	186240107 ⓘ		
Orig. nr.	mm ²	CP55	
Voor kabels	mm	0,2 - 6	
Lengte aanslag	mm	20	
Prijs	€	26,50	

TENGOOLS



Precisie krimp tang. Met krachtoverbrengingsmechanisme (30% minder kracht uit te oefenen). Comfortabel ergonomisch handvat.

Order nr.	186670105 ⓘ		
Orig. nr.	mm	CP58	
Lengte	mm	250	
Capaciteit	AWG	22-10	
Capaciteit	mm ²	0.75-6.0	
Prijs	€	35,00	

TENGOOLS



Automatische krimp tang voor geïsoleerde en niet-geïsoleerde kabelschroenten, 24-10 AWG. Kabelstrip en -knipfunctie met micro instelknop voor kabels, 30-8 AWG.

Order nr.	186680104 ⓘ		
Orig. nr.	mm	CP60	
Voor geïsoleerde kabelschroenten	mm	0.5-6	
Voor niet-geïsoleerde kabelschroenten	mm	0.5-6	
Lengte	mm	210	
Capaciteit	AWG	8-30	
Capaciteit	mm ²	0.13-8	
Capaciteit geïsoleerde kabelschroenten	AWG	10-24	
Capaciteit niet-geïsoleerde kabelschroenten	AWG	10-24	
Prijs	€	20,90	

TENGOOLS



Professionele automatische ontmantel- en krimp tang. Geschikt voor geïsoleerde kabelschroenten van 1.5 tot 6mm en niet-geïsoleerde kabelschroenten van 1.5 tot 2.5mm.

Order nr.	128390101 ⓘ		
Orig. nr.	mm	CP52	
Prijs	€	54,90	

METALWORKS



Automatische kabelschroentkrimp tang voor geïsoleerde kabelschroenten. Met kunststof bekleed handvat.

Order nr.	100072188 ⓘ		
Orig. nr.	mm	VES1000	
Lengte	mm	245	
Capaciteit	AWG	22-18 - 16-14 - 12-10	
Capaciteit DIN	mm ²	0,5-1,0 - 1,5-2,5 - 4-6	
Prijs	€	32,50	

METALWORKS



Automatische kabelschroentkrimp tang voor niet-geïsoleerde kabelschroenten. Met kunststof bekleed handvat.

Order nr.	100071100 ⓘ		
Orig. nr.	mm	VES1100	
Lengte	mm	260	
Capaciteit	AWG	20-18 - 16-14 - 12-10 - 8	
Capaciteit DIN	mm ²	1,5 - 2,5 - 6 - 10	
Prijs	€	33,50	

Kabelschoentangen

METALWORKS



Automatische kabelschoenkrimp tang voor geïsoleerde en niet-geïsoleerde ADENER-hulzen 12-22mm. Met kunststof bekleed handvat.

Order nr.	100071200		
Orig. nr.	VES1200		
Lengte	mm	200	
Capaciteit DIN	mm ²	0,5 - 0,75 - 1 - 1,5 - 2,5 - 4	
Capaciteit ADENER	AWG	22 - 20 - 18 - 16 - 14 - 12	
Prijs	€	39,90	

METALWORKS



Automatische kabelschoenkrimp tang voor geïsoleerde en niet-geïsoleerde ADENER-hulzen 6-10mm. Met kunststof bekleed handvat.

Order nr.	100071300		
Orig. nr.	VES1300		
Lengte	mm	200	
Capaciteit DIN	mm ²	6 - 10 - 16	
Capaciteit ADENER	AWG	10 - 8 - 6	
Prijs	€	44,50	

METALWORKS



Automatische krimp tang voor COAX-leidings. Met kunststof bekleed handvat.

Order nr.	100071500		
Orig. nr.	VES1500		
Lengte	mm	240	
Capaciteit Hex		1,72 - 2,5 - 5,4 - 6,48 - 8,2	
Prijs	€	40,50	

METALWORKS



Automatische krimp tang voor D-SUB en V3.5 fiches. Stalen tang met kwalitatieve krimpklauwen in AISI 4140 materiaal. Gehard HRC 38-45. Beide handvaten van de tang zijn in een 2-component materie PP+TPR voor een aangename en goeie grip.

Order nr.	100071550		
Orig. nr.	VES1550		
Capaciteit	AWG	14 - 22 - 8	
Capaciteit DIN	mm ²	2,5 - 0,5 - 8-10	
Lengte krimp tang	mm	220	
Prijs	€	40,50	

METALWORKS



Automatische kabelschoenkrimp tang voor niet-geïsoleerde en interlocking kabelschoenen. Met kunststof bekleed handvat.

Order nr.	100071600		
Orig. nr.	VES1600		
Lengte	mm	228	
Capaciteit	AWG	20-18 - 16-14 - 12-10	
Prijs	€	43,50	

METALWORKS



Automatische krimp tang voor 4 of 8-draads telefoon- en netwerkbekabeling. Met kunststof bekleed handvat.

Order nr.	100072004		
Orig. nr.	VES2004		
Soort kabel	telefoon type		
Aantal draden	4		
Prijs	€	15,50	

METALWORKS



Kabelkrimp tang voor netwerkkabels.

Order nr.	100072045		
Orig. nr.	VES2045		
Lengte	mm	205	
Capaciteit RJ	10 - 11 - 12 - 45		
Prijs	€	34,50	

METALWORKS



Universele kabelstripper. Cap. 8-28mm. Simpel en onmisbaar.

Order nr.	109070828		
Orig. nr.	VES0828		
Lengte	mm	170	
Capaciteit diameter	mm	8-28	
Prijs	€	4,70	

METALWORKS



Kabelstriptang.

Order nr.	109070058
Orig. nr.	VES0058
Capaciteit	RG58/59/62/3C/4C
Prijs	€ 7,70

METALWORKS



Kabelknijptang. Ratelsysteemmodel. Eenhandsbediening. Voor CU/AL kabels. Niet voor staal of stalen kabels.

Order nr.	100070024
Orig. nr.	VES4024
Lengte	mm 310
Capaciteit maximum	mm ² 240
Prijs	€ 64,00

METALWORKS



Mechanische krimptang voor CU-terminals. Met roterende krimpklauwen en no-full-closure mechanisme.

Order nr.	100073050	100073120
Orig. nr.	VES3050	VES3120
Lengte	mm 390	620
Capaciteit	mm ² 6-50	10-120
Prijs	€ 35,50	83,00

METALWORKS



Mechanische krimptang met krimpcapaciteit 6T voor CU-terminals tot 300mm². Geleverd met 11 drukstukken gaande van 16, 25, 35, 50, 70, 95, 120, 150, 185, 240 en 300mm.

Order nr.	100073300
Orig. nr.	VES3300
Capaciteit	mm 16-300
Prijs	€ 194,00

METALWORKS



Hydraulische kabelknijptang. Guillotine systeem knipt perfect en eenvormig in vergelijking met een mechanische 'hakken'. Een 180° roterend kniphoofd vergemakelijkt voor de gebruiker een eenvoudig positioneren bij het knippen.

Order nr.	100070050
Orig. nr.	VES4050
Lengte	mm 710
Capaciteit elektrische kabel (diameter)	mm 50
Capaciteit knipfunctie CU/AL	mm 20
Capaciteit telefoonkabel (diameter)	mm 38
Capaciteit	mm 4
Prijs	€ 356,00

METALWORKS



Hydraulische ponsset. De oplossing voor het ponsen van gaten en kabelopeningen op verplaatsing. Dank zij de 360° draaibare kop is deze pomp geschikt voor het ponsen op moeilijk bereikbare plaatsen. Lichtgewicht door aluminium behuizing. Geleverd met assen en 6 ponsen (cap. 22 tmm 60mm). In een handige kunststof koffer.

Order nr.	100076000
Orig. nr.	VES6000
Lengte	mm 310
Ponsen	mm 22 - 27,5 - 34 - 43 - 49 - 60
Vermogen	T 6
Koers	mm 22
Prijs	€ 189,00

METALWORKS



Ponsen. Voor VES6000 ponsset.

Order nr.	Orig. nr.	Diameter mm	Prijs €
100076010	VES6000-P22	22	20,50
100076011	VES6000-P27	27,5	24,90
100076012	VES6000-P34	34	31,00
100076013	VES6000-P43	43	39,50
100076014	VES6000-P49	49	44,50
100076015	VES6000-P60	60	54,50

Riveteertangen



Klassieke riveteertang voor de professioneel voor blindklinknagels. Geleverd met 4 kopstukken 2,4, 3,2, 4,0 en 4,8mm. Capaciteit : diam. 2,4 tot 4,8mm voor alle materialen. Aluminium lichaam met stalen handgreep met stalen onderdelen.

Order nr.	727817010 ⓘ
Orig. nr.	RITC701
Capaciteit blindklinknagels in aluminium	mm 2,4 - 3,2 - 4 - 4,8
Lengte	mm 250
Prijs	€ 13,90



Klassieke riveteertang voor blindklinknagels. Geleverd met 4 kopstukken 2,4, 3,2, 4,0 en 4,8mm. Capaciteit: diam. 2,4 tot 4,8mm voor alle materialen. Stalen gestampt lichaam.

Order nr.	116820101 ⓘ
Orig. nr.	HR14
Capaciteit blindklinknagels in aluminium	mm 2,4 - 3,2 - 4,0 - 4,8
Lengte	mm 270
Prijs	€ 26,50



Klassieke riveteertang voor handwerk en industrie. Geleverd met 4 kopstukken voor 2,4, 3,2, 4,0 en 4,8mm.

Order nr.	69070100 ⓘ
Orig. nr.	HR01
Capaciteit blindklinknagels in aluminium	mm 2,4 - 3,2 - 4,0 - 4,8
Lengte	mm 250
Capaciteit blindklinknagels	mm 2,4 - 3,2 - 4,0 - 4,8
Prijs	€ 39,90



Riveteertang met 360° draaibare kop voor blindklinknagels. Gebreveteerd model. Bereikt alle onbereikbare hoekjes. Geleverd met 4 kopstukken 2,4, 3,2, 4,0 en 4,8mm. Capaciteit : diam. 2,4 tot 4,8mm voor alle materialen.

Order nr.	727819010 ⓘ
Orig. nr.	RITC901KN
Capaciteit blindklinknagels in aluminium	mm 2,4 - 3,2 - 4,0 - 4,8
Prijs	€ 21,90



COMPACT

Accordeon-type riveteertang voor klinknagels van 3,2, 4,0, 4,8 en 6,4mm voor alle materialen. Het accordeon-systeem garandeert een soepele krachtoverbrenging. Voor de professional.

Aluminium lichaam met stalen handgreep met stalen onderdelen.

Order nr.	727815010
Orig. nr.	RITC501
Capaciteit blindklinknagels in aluminium	mm 3,2 - 4,0 - 4,8 - 6,4
Prijs	€ 39,90



2 IN 1

Combinatie riveteertang 2 in 1 voor blindklinkmoeren M4, M5 en M6 en blindklinkbouten M4, M5 en M6. Geleverd in een handige kunststof opbergkoffer.

Order nr.	727817100
Orig. nr.	RITC920
Capaciteit blindklinkmoeren in aluminium	M 4 - 5 - 6
Capaciteit blindklinkbouten in aluminium	M 4 - 5 - 6
Prijs	€ 39,90



3 IN 1

360°

Combinatie riveteertang 3 in 1. Voor blindklinknagels 2,4 tot 4,8mm, blindklinkmoeren M4, M5 en M6 en blindklinkbouten M4, M5 en M6. Met 360° draaibare kop. Gebreveteerd model. Bereikt alle onbereikbare hoekjes. Geleverd in een handige kunststof opbergkoffer.

Order nr.	727819090
Orig. nr.	RITC909G
Capaciteit blindklinknagels in aluminium	mm 2,4 - 3,2 - 4,0 - 4,8
Capaciteit blindklinkmoeren in aluminium	M 4 - 5 - 6
Capaciteit blindklinkbouten in aluminium	M 4 - 5 - 6
Prijs	€ 39,90



3 IN 1

Combinatie riveteertang 3 in 1 voor klinknagels 3,2 tot 6,4mm, blindklinkmoeren M4, M5, M6, M8 en M10 en blindklinkbouten M4, M5, M8 en M10. Extra zware uitvoering. De openklapbare hendels garanderen een perfecte krachtoverbrenging en eveneens een compacte opbergmogelijkheid eenmaal ingeklapt. Geleverd in een handige kunststof opbergkoffer. Gebreveteerd model. Accessoires los leverbaar.

Order nr.	727819500
Orig. nr.	RITC950
Capaciteit blindklinknagels in aluminium	mm 3,2 - 4,0 - 4,8 - 6,4
Capaciteit blindklinkmoeren in aluminium	M 4 - 5 - 6 - 8 - 10 - 12
Capaciteit blindklinkbouten in aluminium	M 4 - 5 - 6 - 8
Prijs	€ 79,90



3 IN 1

HEAVY DUTY

360°

Combinatie riveteertang 3 in 1 voor klinknagels 3,2 tot 6,4mm, blindklinkmoeren M4, M5, M6, M8 en M10 en blindklinkbouten M4, M5, M6 en M8 met 360° draaibare kop. Bereikt alle onbereikbare hoekjes. Gebreveteerd model. Extra zware uitvoering. Met 2 extra lange hendels voor een prima krachtoverbrenging. Geleverd in een handige kunststof opbergkoffer. Accessoires los leverbaar.

Order nr.	727819700
Orig. nr.	RITC970
Capaciteit blindklinknagels in aluminium	mm 3,2 - 4,0 - 4,8 - 6,4
Capaciteit blindklinkmoeren in aluminium	M 4 - 5 - 6 - 8 - 10
Capaciteit blindklinkbouten in aluminium	M 4 - 5 - 6 - 8
Prijs	€ 84,90



PNEUMATIC

6,4mm

Pneumatische riveteertang. Cap. 3,2 tot 6,4mm Een professioneel toestel voor seriematig werk.

Order nr.	727816400
Orig. nr.	RITC640
Capaciteit blindklinknagels in aluminium	mm 3,2 - 4,0 - 4,8 - 6,4
Werkdruk	bar 6-8
Luchtverbruik/klinknagel	l 0,9
Koers	mm 19
Prijs	€ 159,00

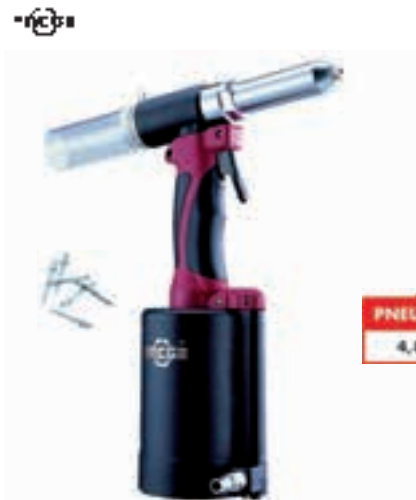

PNEUMATIC

4,8mm

Pneumatische riveteertang. Basismodel. Cap. 2,4 tot 4,8mm. Een professioneel toestel voor seriematig werk.

Order nr.	727814800
Orig. nr.	RITC480
Capaciteit blindklinknagels in aluminium	mm 2,4 - 3,2 - 4,0 - 4,8
Werkdruk	bar 5,5-7
Luchtverbruik/klinknagel	l 0,8
Koers	mm 16
Prijs	€ 129,00



PNEUMATIC

4,8mm

360°

Pneumatische riveteertang. Basismodel. Cap. 2,4 tot 4,8mm. Een professioneel toestel voor seriematig werk. met 360° draaibare kop.

Order nr.	727814810
Orig. nr.	RITC480S
Capaciteit blindklinknagels in aluminium	mm 2,4 - 3,2 - 4,0 - 4,8
Werkdruk	bar 6-8
Luchtverbruik/klinknagel	l 0,8
Koers	mm 16
Prijs	€ 205,00



Accessoires riveteertangen

METALWORK



Multigrip blindklinknagels Alu/st. Deze nagels hebben een breder klembereik, waardoor de voorbereiding minder exact dient te zijn. Een bijkomend voordeel van het breder klembereik is de betere afdichting.

Order nr.	Orig. nr.	Maat mm	VE	Prijs/VE €
747809320	RIBLI3210	3,2x10	200	8,90
747809408	RIBLI4008	4,0x8	200	9,90
747809410	RIBLI4010	4,0x10	200	10,50
747809412	RIBLI4012	4,0x12	200	6,80
747809481	RIBLI4810	4,8x10	200	7,40
747809482	RIBLI4812	4,8x12	200	7,90

METALWORK



Verzinkte blindklinkmoeren (BKM) voor universeel gebruik. Materiaalsterkte : 8.8. VE = verpakkingseenheid. Kunnen bevestigd worden met onze tangen uit het gamma NCG.

Order nr.	Orig. nr.	Type	Maat	Diameter	Boor	Plaatdikte	VE	Prijs/VE €
			mm	mm	mm	mm		€
747801004	RIALU4MM	BKM M4	5,9	6	0,5-3,0	100	18,50	
747801005	RIALU5MM	BKM M5	6,9	7	0,3-3,0	100	20,50	
747801006	RIALU6MM	BKM M6	8,9	9	0,3-3,0	100	23,50	
747801008	RIALU8MM	BKM M8	10,9	11	0,5-3,0	50	16,50	
747801010	RIALU10MM	BKM M10	11,9	12	0,5-3,0	50	20,50	

METALWORK



Verzinkte stalen blindklinkbouten (BKB) voor universeel gebruik. Materiaalsterkte : 8.8. VE = verpakkingseenheid. Kunnen bevestigd worden met onze tangen uit het gamma NCG.

Order nr.	Orig. nr.	Type	Maat	Boor	Plaatdikte	VE	Prijs/VE €
			mm	mm	mm		€
747802040	RIBKBM4	BKB M4	5,5	0,5-2,0	25	21,90	
747802050	RIBKBM5	BKB M5	6,6	0,5-2,0	25	23,50	
747802060	RIBKBM6	BKB M6	7,8	0,5-2,5	25	24,90	
747802080	RIBKBM8	BKB M8	9,9	1,0-3,0	25	46,50	

METALWORK



NEW

Assortiment blinklinknagels, -moeren en/of -bouten in een handige navulbare kunststof koffer.

Order nr.	747804001	747805001	747809001
Orig. nr.	RISET400	RISET500	RISET900
Blindlinknagels			
Aantal blindlinknagels 3,2 x 10mm			200
Aantal blindlinknagels 4,0 x 8mm			200
Aantal blindlinknagels 4,0 x 10mm			200
Aantal blindlinknagels 4,0 x 12mm			100
Aantal blindlinknagels 4,8 x 10mm			100
Aantal blindlinknagels 4,8 x 12mm			100
Aantal blindlinkmoeren M4	100	100	
Aantal blindlinkmoeren M5	100	100	
Aantal blindlinkmoeren M6	100	100	
Aantal blindlinkmoeren M8	50	50	
Aantal blindlinkmoeren M10	50	50	
Aantal blindlinkbouten M4			25
Aantal blindlinkbouten M5			25
Aantal blindlinkbouten M6			25
Aantal blindlinkbouten M8			25
Prijs	€ 62,90	108,00	42,90



Poulietrekkers

TENGOOLS



4-delige set bestaande uit 1 combinatie-poulietrekker met 3 armen maar met de mogelijkheid om de poulietrekker zowel als 2-armig of als 3-armig toestel te gebruiken. Met omkeerbare armen voor intern en extern trekken. TC-tray.

Order nr.	03980109		
Orig. nr.	TT804		
Vastklemdiepte	mm	100	
Vastklembreedte	mm	130	
Prijs	€	41,50	

TENGOOLS



3-armige poulietrekker. Combi-model. Model met de mogelijk om ofwel met 2 ofwel met 3 armen te werken. chroom vanadium staal. Gesmeed en gehard. Inductiegeharde spindel.

Order nr.	131910101	128420106
Orig. nr.	SP11	SP22
Reikwijdte	mm 76-102	78-178
Maximum bereik	mm 89	137
Prijs	€	54,50
		98,90

TENGOOLS



Poulietrekker. Klassiek Europees 2-armig model. Chroom vanadium staal. Inductiegeharde spindel. Matverchroomd. Zowel binnen- als buitentrekker.

Order nr.	Orig. nr.	Interne klemming (a1) mm	Externe klemming (a2) mm	Diepte klemming (b) mm	Schroef-draad spindel	Lengte spindel mm	Prijs €
143930105	SP1410	90	133	97	M14x1,5	140	56,00
143930204	SP1810	130	170	97	M14x1,5	140	70,00
143930303	SP2215	158	209	150	M20x2	210	109,00
143930402	SP2615	200	256	150	M20x2	210	113,00
143930501	SP3320	250	325	205	M26x2	220	189,00

TENGOOLS



5-delige set bestaande uit display gevuld met poulietrekkers in verschillende maten. De Poulietrekkers zijn regelbaar voor intern en extern trekken.

Order nr.	144740107		
Orig. nr.	DIS-SP05		
Poulietrekkers	SP1410 - SP1810 - SP2215 - SP2615 - SP3320		
Prijs	€	569,00	

TENGOOLS



Poulietrekker. Klassiek Europees 2-armig model met Quick-action aanpassing. Chroom vanadium staal. Inductiegeharde spindel. Matverchroomd. Zowel binnen- als buitentrekker.

Order nr.	Orig. nr.	Interne klemming (a1) mm	Externe klemming (a2) mm	Diepte klemming (b) mm	Schroef-draad spindel	Lengte spindel mm	Prijs €
178760104	SP1410Q	90	133	97	M14x1,5	140	82,00
178760203	SP1810Q	130	170	97	M14x1,5	140	87,00
178760302	SP2215Q	158	209	150	M20x2	210	132,00
178760401	SP2615Q	200	256	150	M20x2	210	148,00
178760500	SP3320Q	250	325	205	M26x2	220	179,00

TENGOOLS



5-delige set bestaande uit display gevuld met poulietrekkers in verschillende maten. De Poulietrekkers zijn regelbaar voor intern en extern trekken met quick-action aanpassing.

Order nr.	178761003		
Orig. nr.	DIS-SP05Q		
Poulietrekkers	SP1410Q - SP1810Q - SP2215Q - SP2615Q - SP3320Q		
Prijs	€	449,00	

TENGOOLS



Poulietrekker. Klassiek Europees 3-armig model. Chroom vanadium staal. Inductiegeharde spindel. Matverchroomd. Zowel binnen- als buitentrekker.

Order nr.	Orig. nr.	Interne klemming (a1) mm	Externe klemming (a2) mm	Diepte klemming (b) mm	Schroef-draad spindel	Lengte spindel mm	Prijs €
178770103	SP31410	90	133	97	M14x1,5	140	85,00
178770202	SP31810	130	170	97	M14x1,5	140	90,00
178770301	SP32215	160	211	150	M20x2	210	127,00
178770400	SP32615	205	261	150	M20x2	210	201,00
178770509	SP33320	252	327	205	M26x2	220	201,00

TENGOOLS



Poulietrekker. Klassiek Europees 3-armig model met quick-action aanpassing. Chroom vanadium staal. Inductiegeharde spindel. Matverchroomd. Zowel binnen- als buitentrekker.

Order nr.	Orig. nr.	Interne klemming (a1) mm	Externe klemming (a2) mm	Diepte klemming (b) mm	Schroef-draad spindel	Lengte spindel mm	Prijs €
178780102	SP31410Q	90	133	97	M14x1,5	140	99,00
178780201	SP31810Q	130	170	97	M14x1,5	140	103,00
178780300	SP32215Q	160	211	150	M20x2	210	142,00
178780409	SP32615Q	205	261	150	M20x2	210	179,00
178780607	SP33320Q	252	327	205	M26x2	220	209,00

IFELTA



Poulietrekker. "Master" model. 2-armig model. Vervaardigd uit chroom vanadium staal. Verzinkt. Geharde armen. Inductie geharde spindel.

Order nr.	Orig. nr.	Capaciteit mm	Maximum diameter mm	Maximum hoogte mm	Prijs €
770108010	IZ7010320810	08x10	80	100	63,50
770101210	IZ7010321210	12x10	120	100	69,00
770101615	IZ7010321615	16x15	160	150	111,00
770102015	IZ7010322015	20x15	200	150	122,00
770102520	IZ7010322520	25x20	250	200	260,00
770105220	IZ7010322520	52x20	520	200	565,00

IFELTA



Stand voor type IZ 7010-poulietrekkers. Verkrijgbaar als lege stand of als gevulde stand.

Order nr.	770109999	770106105
Orig. nr.	IZ7010206105	IZ7010006105
Omschrijving	lege stand	gevulde stand
Prijs €	10,50	605,00

IFELTA



Poulietrekker. Master model. 3-armig model. Vervaardigd uit chroom vanadium staal. Verzinkt. Geharde armen. Inductie geharde spindel.

Order nr.	770203720	770205220
Orig. nr.	IZ7020323720	IZ7020325220
Capaciteit mm	37x20	52x20
Maximum diameter mm	370	520
Maximum hoogte mm	200	200
Prijs €	575,00	785,00

IFELTA



Poulietrekker. "Battery" model. 2-armig. Met T-vormig hendel. Vervaardigd uit chroom vanadium staal. Verzinkt. Geharde armen. Inductie geharde spindel.

Order nr.	770506060	770508080
Orig. nr.	IZ7050320606	IZ7050320808
Breedte mm	60	80
Hoogte mm	60	80
Prijs €	27,50	29,50

IFELTA



Poulietrekker. "Battery" model. 3-armig. Met T-vormig hendel. Vervaardigd uit chroom vanadium staal. Verzinkt. Geharde armen. Inductie geharde spindel.

Order nr.	Orig. nr.	Capaciteit	Maximum diameter	Maximum hoogte	Prijs
			mm	mm	€
770604060	IZ7060320406	06x04	60	40	35,00
770606060	IZ7060320606	06x06	60	60	36,00
770608080	IZ7060320808	08x08	80	80	37,00



Poulietrekker. Standaard model. 2-armig model. Vervaardigd uit chroom vanadium staal. Verzinkt. Geharde armen. Inductie geharde spindel.

Order nr.	Orig. nr.	Capaciteit	Maximum diameter	Maximum hoogte	Prijs
		mm	mm	mm	€
770308080	IZ7030320808	08x08	80	80	26,50
770301212	IZ7030321212	12x12	120	120	52,00
770301616	IZ7030321616	16x16	160	160	77,50



Poulietrekker. Standaard model. 3-armig model. Vervaardigd uit chroom vanadium staal. Verzinkt. Geharde armen. Inductie geharde spindel.

Order nr.	770408080	770401212
Orig. nr.	IZ7040320808	IZ7040321212
Capaciteit	mm 08x08	12x12
Maximum diameter	mm 80	120
Maximum hoogte	mm 80	120
Prijs	€ 48,50	71,00
Order nr.	770401616	770402320
Orig. nr.	IZ7040321616	IZ7040322320
Capaciteit	mm 16x16	23x20
Maximum diameter	mm 160	160
Maximum hoogte	mm 160	195
Prijs	€ 106,00	155,00



Poulietrekker. S-vormig model. 2-armig. Vervaardigd uit chroom vanadium staal. Verzinkt. Geharde armen. Inductie geharde spindel.

Order nr.	770702013
Orig. nr.	IZ7070322013
Capaciteit	mm 20x13
Maximum diameter	mm 200
Maximum hoogte	mm 130
Prijs	€ 73,00



Poulietrekker. S-vormig model. 3-armig. Vervaardigd uit chroom vanadium staal. Verzinkt. Geharde armen. Inductie geharde spindel.

Order nr.	770802013
Orig. nr.	IZ7080322013
Capaciteit	mm 20x13
Maximum diameter	mm 200
Maximum hoogte	mm 130
Prijs	€ 100,00



Poulietrekker. Universeel model. 2-armig. Vervaardigd uit chroom vanadium staal. Verzinkt. Geharde armen. Inductie geharde spindel.

Order nr.	770902222
Orig. nr.	IZ7090322222
Capaciteit	mm 22x22
Maximum diameter	mm 220
Maximum hoogte	mm 220
Prijs	€ 87,00



Poulietrekker. Universeel model. 3-armig. Vervaardigd uit chroom vanadium staal. Verzinkt. Geharde armen. Inductie geharde spindel.

Order nr.	771002222
Orig. nr.	IZ7100322222
Capaciteit	mm 22x22
Maximum diameter	mm 220
Maximum hoogte	mm 220
Prijs	€ 113,00

Wisselstukken poulietrekkers



Koppelstuk voor verlengstukken voor poulietrekker IZ7010 types.

Order nr.	770102033	770103033	770104033
Orig. nr.	IZ7010322033	IZ7010323033	IZ7010324033
Voor mm	8x10 10x12	16x15 20x15 25x20 35x20	37x20 52x20 65x20
Capaciteit mm	08x08	12x12	16x16
Prijs €	21,00	24,50	53,00



Koppelstukken voor poulietrekker IZ7010 types.

Order nr.	Orig. nr.	Voor mm	Prijs €
770108033	IZ7010600833	8x10 10x12	8,00
770101633	IZ7010601633	16x15 20x15 25x20 35x20	13,50
770102533	IZ7010602533	37x20 52x20 65x20	24,50



Vervangarmen voor poulietrekker IZ7010 types.

Order nr.	Orig. nr.	Voor mm	Prijs €
770108022	IZ7010600822	8x10 10x12	15,90
770101622	IZ7010601622	16x15 20x15 25x20 35x20	27,50
770102522	IZ7010602522	37x20 52x20 65x20	46,50



Vervangspindel voor poulietrekker IZ7010 types.

Order nr.	Orig. nr.	Maat	Voor mm	Prijs €
770108440	IZ7010100844	M14X1.5	8x10 - 12x10	14,50
770101644	IZ7010101644	M20X2.0	16x15 - 20x15	27,00
770102544	IZ7010102544	M27X2.0	25x20	46,50
770103544	IZ7010103544	M33X2.0	35x20 - 37x20	60,50
770105244	IZ7010105244	M39X2.0	52x20	61,50



Vervangarmen voor poulietrekkers IZ7030 types.

Order nr.	Orig. nr.	Voor mm	Prijs €
770308022	IZ7030600822	08x08	11,50
770301222	IZ7030601222	12x12	12,50
770301622	IZ7030601622	16x16	21,00
770302333	IZ7030602322	23x20	29,50



Vervangspindel voor poulietrekkers IZ7030 types.

Order nr.	Orig. nr.	Maat	Voor mm	Prijs €
770308044	IZ7030100844	M12X1.5	08x08	11,50
770301244	IZ7030101244	M14X1.5	12x12	16,90
770301644	IZ7030101644	M18X2	16x16	19,00
770302344	IZ7030102344	M22X2	23x20	26,50



Vervangarmen voor poulietrekkers IZ7050 en IZ7060 types.

Order nr.	Orig. nr.	Voor mm	Prijs €
770504022	IZ7050600422	06x04	6,90
770506022	IZ7050600622	06x06	8,40
770508022	IZ7050600822	08x08	8,40



Vervangspindel voor poulietrekkers IZ7050 en IZ7060 types.

Order nr.	Orig. nr.	Voor mm	Prijs €
770504044	IZ7050100444	06x04	8,40
770506044	IZ7050100644	06x06	8,40
770508044	IZ7050100844	08x08	10,50

Teng Tools in the shop



All the too



Tools you need, all guaranteed!

Aambeelden

METALWORKS



Aambeeld. Gewicht 50 kg. In niet-gehard gietstaal met geslepen bovenvlak. Met 1 hoorn. Afmetingen werkvlak 310mmx113mm. Lengte hoorn 180mm.

Order nr.	724555050
Orig. nr.	GR50AB
Prijs	€ 250,00

Beitels

TENGOOLS



Speciaal staal verchroomd. Platte beitel. Inductiegehard.

Order nr.	117020909	117021006	117021105
Orig. nr.	CC150F	CC200F	CC250F
Maat mm	19	25	25
Omschrijving	platte beitel	platte beitel	platte beitel
Prijs	€ 9,90	14,50	18,50

DELTA



Platte beitel DIN 6453. Speciaal staal. Verchroomd.

Order nr.	755002000	755002500	755003000
Orig. nr.	IZ5500400200	IZ5500400250	IZ5500400300
Breedte top mm	26	29	29
Prijs	€ 7,00	9,50	10,50

DELTA



Metalbeitel DIN6453. Speciaal staal. Verchromd. Met veiligheidshandvat.

Order nr.	755009250	755009300
Orig. nr.	IZ5500470250	IZ5500470300
Breedte top mm	29	29
Prijs	€ 17,50	18,90

Doorslagen

TENGOOLS



Set van 6 doorslagen diam. 3 mm tot 8 mm. Speciaal staal. Inductiegehard. Verchroomd. Met speciaal geharde kop. Geleverd in handige kunststof houder.

Order nr.	69110104
Orig. nr.	PPS06
Lengte mm	150
Diameter top mm	3 - 4 - 5 - 6 - 7 - 8
Prijs	€ 39,90

TENGOOLS



Cilindrische doorslagen. Speciaal staal. Inductiegehard. Verchroomd. Met speciaal geharde kop.

Order nr.	Orig. nr.	Maat mm	Lengte mm	Prijs €
117020107	PP03	3	150	5,80
117020206	PP04	4	150	5,80
117020305	PP05	5	150	5,80
117020404	PP06	6	150	5,80
117020503	PP07	7	150	6,90
117020602	PP08	8	150	6,90

TENGOOLS



Centerpunt. Speciaal staal. Inductiegehard. Verchroomd. Met speciaal geharde kop.

Order nr.	117021204
Orig. nr.	CP05
Maat mm	5
Lengte mm	150
Prijs	€ 8,40

TENGOOLS



Automatisch centerpunt 135 mm met pocket clip.

Order nr.	122260102
Orig. nr.	SCP01
Lengte mm	135
Prijs	€ 14,50

Hamers

TENGOOLS



Bankhamer DIN 1040. IZ-type: steel in hickory. HMEG: kunststof steel.

Order nr.	Orig. nr.	Lengte mm	Gewicht kg	Prijs €
709000029	IZ5800240200	300	0,24	11,50
117030106	HMEG300	300	0,42	14,50
117030205	HMEG500	320	0,65	17,50
117030304	HMEG800	350	0,80	22,50
709000032	IZ5800242000	-	2,26	42,50

TENGOOLS



Herstelkit: kunststof steel en wig voor HMEG.

Order nr.	Orig. nr.	Voor	Gewicht kg	Prijs €
117031005	HMEG300RK	HMEG300	0,10	8,80
117031104	HMEG500RK	HMEG500	0,13	10,50
117031203	HMEG800RK	HMEG800	0,15	10,90

TENGOOLS



Bolkophamer. Engels model. Steel in kunststof.

Order nr.	Orig. nr.	Diameter kop mm	Gewicht kg	Prijs €
105880058	HMBP12	24	0,48	17,50
105880108	HMBP16	27	0,68	19,90
105880207	HMBP24	28	0,98	27,50
105880306	HMBP32	29	1,28	31,50

TENGOOLS



Herstelkit: steel + wig voor HMBP.

Order nr.	Orig. nr.	Voor	Gewicht kg	Prijs €
105881106	HMBP12RK	herstelkit: steel + wig voor HMBP12	0,11	9,80
105881205	HMBP16RK	herstelkit: steel + wig voor HMBP16	0,17	10,50
105881304	HMBP24RK	herstelkit: steel + wig voor HMBP24	0,20	12,90
105881403	HMBP32RK	herstelkit: steel + wig voor HMBP32	0,24	13,50

METAL WORKS



7-delige uitdeukset bestaande uit de 4 meeste gebruikte tassen en 3 plaatslagerhamers, alle met een glasvezelsteel. Verpakt in een handige kunststof koffer.

Order nr.	754751001
Orig. nr.	CALS1001AA
Gewicht	kg 1,00
Prijs	€ 29,90

TENGOOLS



5-delige hamerset bestaande uit 2 terugslagvrije hamers en 3 plaatwerkhamers. Geleverd in een PVC tray. PS-tray.

Order nr.	122440100
Orig. nr.	TTPSAD
Diameter kop van terugslagvrije hamers	mm 35 et 55
Plaatwerkhamer	met rechte pin, met ronde puntige kop, met vierkante kop
Gewicht	kg 5,76
Prijs	€ 105,00

TENGOOLS



Plaatlagershamer. Prima kwaliteit met hickory-houten handvat. Model met 1 ronde, rechte, platte kop en 1 rechte punt.

Order nr.	117900100
Orig. nr.	HMBH01
Lengte	mm 325
Gewicht	kg 0,43
Prijs	€ 31,50

TENGOOLS



Plaatslagershamer. Prima kwaliteit met hickory-houten handvat. Model met 1 ronde, rechte, platte kop en 1 ronde punt kop.

Order nr.	117900209		
Orig. nr.	HMBH02		
Lengte	mm	325	
Gewicht	kg	0,41	
Prijs	€	31,50	

TENGOOLS



Plaatslagershamer. Prima kwaliteit met hickory-houten handvat. Model met platte kop.

Order nr.	117900308		
Orig. nr.	HMBH03		
Lengte	mm	325	
Gewicht	kg	0,44	
Prijs	€	33,50	

TENGOOLS



Terugslagvrije hamer. De kop is gevuld met fijne staaldeeltjes om te verhinderen dat de hamer terugkaatst bij het slaan. Zwarte uitvoering.

Order nr.	Orig. nr.	Diameter kop mm	Gewicht kg	Prijs €
117870105	HMDH35	35	0,30	22,50
186360103	HMDH45	45	0,50	26,90
117870204	HMDH55	55	0,98	33,90
186360202	HMDH65	65	1,37	39,90

TENGOOLS



Hamer met nylon kop en rubber kop. Ronde, stalen steel met geperforeerd rubber handvat.

Order nr.	105810105		
Orig. nr.	HMSF		
Diameter kop	mm	22	
Gewicht	kg	0,67	
Prijs	€	24,90	

TENGOOLS



Set extra koppen voor HMSF.

Order nr.	105810204		
Orig. nr.	HMSFRK		
Gewicht	kg	0,04	
Prijs	€	10,50	

DELTA



Hamer volrubber kop. Ronde stalen steel met geperforeerd rubber handvat.

Order nr.	758704000		
Orig. nr.	IZ5870000400		
Diameter kop	mm	104	
Gewicht	kg	0,67	
Prijs	€	22,50	

TENGOOLS



Klawwamer. Chroom, ovaal stalen handvat bekleed met rubber.

Order nr.	116990201		
Orig. nr.	HMCH16A		
Lengte	mm	312	
Diameter kop	mm	27	
Gewicht	kg	0,70	
Prijs	€	19,90	

Holpijpen



Holpijpen DIN 7200. Chroom vanadium.

Order nr.	Orig. nr.	Maat	Lengte mm	Prijs €
757003030	IZ5700240003	3	105	5,40
757004040	IZ5700240004	4	105	5,90
757005050	IZ5700240005	5	110	6,60
757006060	IZ5700240006	6	110	7,00
757007070	IZ5700240007	7	115	7,80
757008080	IZ5700240008	8	115	8,20
757009090	IZ5700240009	9	120	8,80
757001010	IZ5700240010	10	120	9,80
757001111	IZ5700240011	11	125	9,50
757001212	IZ5700240012	12	125	11,50
757001313	IZ5700240013	13	130	12,90
757001414	IZ5700240014	14	130	14,50
757001515	IZ5700240015	15	140	12,50
757001616	IZ5700240016	16	135	14,90
757001717	IZ5700240017	17	-	14,50
757001818	IZ5700240018	18	140	18,90
757001919	IZ5700240019	19	145	17,50
757002020	IZ5700240020	20	145	22,00
757002121	IZ5700240021	21	150	19,50
757002222	IZ5700240022	22	150	20,00
757002323	IZ5700240023	23	160	21,50
757002424	IZ5700240024	24	160	23,00
757002525	IZ5700240025	25	170	28,50
757002626	IZ5700240026	26	170	25,50
757002727	IZ5700240027	27	180	26,50
757002828	IZ5700240028	28	180	42,50



Set holpijpen gaande van diameter 3 tot 14 mm.

Order nr.	757002110	757002112
Orig. nr.	IZ5700242110	IZ5700242112
Aantal stuks	10	12
Holpijpen	mm 3-12	3-14
Prijs	€ 66,00	88,50

Koevoeten



Set van 3 priemen voorzien van een stevig handvat. Universeel toepasbaar. TTX-tray.

Order nr.	117860106
Orig. nr.	TTXPB3A
Lengte	mm 300 - 450 - 550
Prijs	€ 37,90



Extra zware priem - koevoet met zware chroom vanadium schacht en kunststof handvat. Met platte gespleten v-top. Lengte 300mm.

Order nr.	118110105
Orig. nr.	PB12A
Lengte	mm 300
Prijs	€ 13,50



Extra zware priem - koevoet met zware chroom vanadium schacht en kunststof handvat. Met gebogen platte top. Lengte 450mm.

Order nr.	118110204
Orig. nr.	PB18A
Lengte	mm 450
Prijs	€ 19,50



Extra zware priem - koevoet met zware chroom vanadium schacht en kunststof handvat. Met platte top. Lengte 550mm.

Order nr.	118110303
Orig. nr.	PB22A
Lengte	mm 550
Prijs	€ 21,90



Vierkante kop en achthoekige greep.

Order nr.	212240105	212240204
Orig. nr.	212240105	212240204
Lengte	mm 1200	1500
Prijs	€ 32,50	39,90

TENGTTOOLS



Set van 3 koevoeten. Koevoeten van verschillende lengtes en met een ronde, spitse punt aan het ene eind en een vlakke ronde haak aan het andere einde. TTX-tray.

Order nr.	100690106		
Orig. nr.	TTXPB3		
Lengte	mm	300 - 400 - 500	
Prijs	€	51,50	

TENGTTOOLS



Koevoet met een ronde, spitse punt aan het ene eind en een vlakke ronde haak aan het andere einde. Speciaal gehard staal. Matverchroomd.

Order nr.	116980103	116980202	116980301
Orig. nr.	PB12	PB16	PB20
Lengte	mm	300	400
Prijs	€	14,90	19,90

TENGTTOOLS



Koevoet. Medium carbon steel. HRC 40 ±2°.

Order nr.	Orig. nr.	Lengte mm	Prijs €
151540101	AT20512	304	12,50
151540200	AT20516	406	22,50
151540309	AT20520	508	23,50
151540408	AT20524	609	31,90

IZELTA



Koevoet plat model. Gehard en getemperd chroom vanadium staal. Matverchroomd.

Order nr.	Orig. nr.	Lengte mm	Prijs €
763504000	IZ6350400400	400	13,50
763505000	IZ6350400500	500	17,50
763506000	IZ6350400600	600	20,50

IZELTA



Koevoet plat model met gebogen top. Gehard en getemperd chroom vanadium staal. Matverchroomd.

Order nr.	763606000		
Orig. nr.	IZ6360400600		
Lengte	mm	600	
Prijs	€	22,50	



Koevoet.

Order nr.	212140107	212140206
Orig. nr.	212140107	212140206
Lengte	mm	500
Diameter	mm	16
Prijs	€	6,90

Priemen

TENGTTOOLS



Set bestaande uit 4 haken en pinnen met een aluminium handvat. Zeer algemeen bruikbaar. Ook verkrijgbaar in display.

Order nr.	172260101	
Orig. nr.	TM149	
Prijs	€	13,90

TENGTTOOLS



4-delige set bestaande uit 1 schraper, 1 priem en 2 haken. Met een ergonomisch twee componenten handvat. TC-tray.

Order nr.	117690107	
Orig. nr.	TTSR04	
Prijs	€	26,50

TENGTTOOLS



Priem. Met rond-haakse top met chroom vanadium schacht. Zwart-grijs ergonomisch twee componenten handvat met ophangopening.

Order nr.	117690305	
Orig. nr.	MDH-S	
Lengte	mm	205
Prijs	€	8,90

TENGTTOOLS



Priem met rechte chroom vanadium schacht. Zwart-grijs ergonomisch twee componenten handvat met ophangopening. Leverbaar met ofwel ronde ofwel vierkant schacht.

Order nr.	63090104	63090203
Orig. nr.	MDA-R	MDA-SQ
Lengte	mm	220
Ontwerp schacht		rond
Lengte schacht	mm	100
Prijs	€	7,80

TENGOOLS



Priem met 90° haakse top met chroom vanadium schacht. Zwart-grijs ergonomisch twee componenten handvat met ophangopening.

Order nr.	117690206	
Orig. nr.	MDHL	
Lengte	mm	245
Prijs	€	8,30

Schrappers

TENGOOLS



Schraper. Met rechte chroom vanadium schacht met 22mm brede platte bek. Zwart-grijs ergonomisch twee componenten handvat met ophangopening.

Order nr.	03130101	
Orig. nr.	MD-SCR	
Lengte	mm	295
Breedte	mm	22
Prijs	€	14,90

Publiciteits materiaal

TENGOOLS



Transfersticker Teng tools. Leverbaar in 3 verschillende afmetingen.

Order nr.	36513109	36513208	36513307
Orig. nr.	ST-R130	ST-R200	ST-R400
Formaat	13x8cm	20x12cm	40x24cm
Prijs	€ 2,80	6,60	10,90

TENGOOLS



Sticker Teng Tools.

Order nr.	802104020	
Orig. nr.	TTST-40X20CM	
Formaat	40x20 cm	
Prijs	€	12,50

TENGOOLS



Balpen Teng Tools.

Order nr.	802000520	
Orig. nr.	TTBP	
Prijs	€	1,90

TENGOOLS



Muurvlag.

Order nr.	802000107	
Orig. nr.	TTV	
Afmetingen (l x b x h)	mm	2000 x 1500 x 0
Prijs	€	35,00

TENGOOLS



Teng tools spandoek.

Order nr.	802000105	
Orig. nr.	TTSP	
Afmetingen (l x b x h)	mm	2000 x 800 x 0
Prijs	€	49,00

TENGOOLS



Tengtools cap. Luxe uitvoering met prima borduring van het Tengtools ogen logo.

Order nr.	802000505	
Orig. nr.	TTC	
Prijs	€	5,90

TENGOOLS



T-shirt Teng Tools.

Order nr.	800010770	800010780	800010790
Orig. nr.	TTT-REM	TTT-REL	TTT-REXL
Maat	M	L	XL
Prijs	€ 9,90	9,90	10,50

HUSQVARNA JM RACING TEAM

Het JM racing team, onder leiding van Jacky Martens, is de technische partner voor de Europese activiteiten van het Husqvarna motorcrosssteam. Ook zij kiezen voor Teng Tools!

Jacky Martens bracht in 1993 een revolutie in de motorcross te weeg door met een 633cc viertakt Husqvarna de wereldtitel te veroveren. Martens was het gelukt een middelmatig presterende motor om te tunen naar een krachtige GP machine waarmee, hij de door tweetakmachines gedomineerde concurrentie het nakijken gaf. In die tijd vooraf door velen een onmogelijk geachte prestatie. Deze wereldtitel is het hoogtepunt van een actieve motorsportcarriere met talloze (inter-) nationale en Grand Prix overwinningen en die meer dan 20 jaar omspant.

"In het JM Racing team draait alles om leren en groeien in het MX racen", zegt bezieler en teambaas Jacky Martens.

"Het is ons doel om een professioneel kader te creëren rondom een mix van jonge talentrijke en ervaren rijders, die zich hierin ontwikkelen tot MX toppers van wereldklasse. JM Racing voorziet zijn rijders van verfijnde technische know-how en een aangepaste persoonlijke training gebaseerd op tientallen jaren van GP ervaring. De rijders strijden in de MX1 en MX2 klasse op internationaal en Grand Prix niveau."



**TENG TOOLS FOR
HUSQVARNA**





THE PIONEERS OF MOTOCROSS

 Husqvarna



Beugelzagen

TENGOOLS



Zaaghouder in kunststof met anti-slip handvat. Voor 300mm zaagbladen. Kan gebruikt worden als sleutelgat-zaag.

Order nr.	118250109
Orig. nr.	704
Bladlengte	variabel
Prijs	€ 9,60

TENGOOLS



Metaal beugelzaag. L.300mm. In giet-aluminium frame. In het frame is een opbergruimte verwerkt voor een extra zaagblad. Grip-vriendelijk handvat. Geleverd met bi-metaal zaagblad.

Order nr.	74350109
Orig. nr.	701
Frame diepte	mm 390
Lengte zaagblad	mm 300
Afmetingen frame	mm 25x12
Prijs	€ 23,90

TENGOOLS



NEW

Aluminium beugel met ergonomisch rubberen handgreep. HSS 24 tanden zaagblad. 45/90 graden snijhoek.

Order nr.	186910204
Orig. nr.	701N1
Bladlengte	mm 300
Maximum lengte	mm 395
Prijs	€ 28,90

TENGOOLS



NEW

Aluminium beugel met ergonomisch rubberen handgreep. HSS 24 tanden zaagblad. 45/90 graden snijhoek.

Order nr.	186910105
Orig. nr.	701N
Bladlengte	mm 300
Maximum lengte	mm 395
Prijs	€ 27,90

TENGOOLS



Bi-metaal vervangzaagbladen.

Order nr.	74350208
Orig. nr.	702
Lengte zaagblad	mm 300
Aantal	2
Prijs	€ 7,70

TENGOOLS



Junior beugelzaag voor hout, metaal, plastic, enz... Het blad kan worden vastgezet in 6 verschillende posities. Geleverd met 3 zaagbladen.

Order nr.	69360105
Orig. nr.	705
Frame diepte	mm 50
Bladlengte	mm 150
Prijs	€ 10,50

TENGOOLS



Bi-metaal vervangzaagbladen.

Order nr.	69360204
Orig. nr.	705-5
Lengte zaagblad	mm 150
Aantal	5
Prijs	€ 7,60

TENGOOLS



Schrobzaag met vervangzaagblad voor hout en metaal. Het zaagblad kan vastgezet worden in 4 verschillende posities. Geleverd met 2 zaagbladen - 1 voor hout en 1 voor metaal.

Order nr.	20090106
Orig. nr.	703
Maximum lengte	mm 330
Prijs	€ 19,50

TENGOOLS



Zaagblad voor schrobzaag 703.

Order nr.	20090205	20090304
Orig. nr.	703-10	703-24
Toepassing	hout	metaal
Prijs	€ 8,60	8,60

Breekmessen

TENGTTOOLS



Set met 5 breekmessen en 35 vervangmessen. TC-tray.

Order nr.	174480103
Orig. nr.	TTK40
Afmetingen (l x b x h)	mm 270 x 143 x 50
Prijs	€ 48,90

TENGTTOOLS



Universeel mes met intrekbaar mes. Geleverd met 2 mesjes.

Order nr.	105860100
Orig. nr.	710
Lengte	mm 160
Prijs	€ 5,90

TENGTTOOLS



Universeel mes met intrekbaar mes. Gebruiksvriendelijke rubbergrip. Geleverd met 2 mesjes.

Order nr.	118260108
Orig. nr.	710N
Lengte	mm 180
Prijs	€ 13,50

TENGTTOOLS



Alu mes - safe auto-return met 6 mesjes.

Order nr.	173220104
Orig. nr.	711
Lengte	mm 175
Prijs	€ 16,50

TENGTTOOLS



Universeel mes - plooibaar met 3 mesjes.

Order nr.	173220203
Orig. nr.	712
Lengte	mm 178
Prijs	€ 18,50

TENGTTOOLS



Alu mes - plooibaar mini model 10cm.

Order nr.	173220302
Orig. nr.	PJKF
Lengte	mm 98
Prijs	€ 8,70

TENGTTOOLS



710A

710F

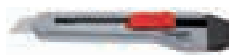

710C



710G

Breekmes. Met mesbreker en zakclip.

Order nr.	Orig. nr.	Totale lengte mm	Breedte mes mm	Materie	Prijs
177710100	710A	130	9	metaal	3,70
177710407	710C	160	18	kunststof	3,50
177710209	710F	140	9	kunststof	3,40
177710308	710G	180	18	kunststof, met vastzetschroef	6,90
186880100	710H	125		kunststof	2,80

TENGTTOOLS

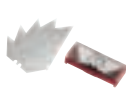

NEW

Vervangmessen voor schuifmes 710/710N/711.

Order nr.	Orig. nr.	Lengte mm	Breedte mes mm	Aantal stuks	Voor type	Prijs
105861108	710-10	60		10	710/710N/711	5,50
105861207	710-100	60		100	710/710N/711	36,50
186890109	710-10H	50		10	710/710N/711	11,50
186890208	710-100H	50		100	710/710N/711	76,90
177711207	710A-100		9	100	710A/F	22,50
177711306	710F-100		18	100	710C/G	32,50
177711108	710F-10		18	10	710C/G	3,50
105860308	710U-10			10	PJKF	3,50
177711009	710A-10		9	10	710A	2,70
105860209	710-5			5	712	5,90

TENGTTOOLS



Handontbramer MINI. Met vervangbaar HSS mesje. Het mesblad past zich aan aan de vorm van het werkstuk. Voor buizen, randen, gaten.

Order nr.	173040205
Orig. nr.	DET02
Prijs	€ 8,50

TENGOOLS



Ontbraamtoestel met vervangbare HSS messen. Het mesblad past zich aan aan de vorm van het werkstuk. Voor buizen, randen, gaten. Geleverd met 2 messen

Order nr.	173040106
Orig. nr.	DET01
Prijs	€ 13,50

TENGOOLS



2 Extra messen voor DET01.

Order nr.	173041005
Orig. nr.	DET01RK
Prijs	€ 9,90

Boutenscharen

TENGOOLS



Boutenscharen. Geharde snijkanten (HRC55-60). Snijhoek 30°. Zelfcenterende instelling van de messen dankzij de centerbout. Robuuste uitvoering met 2 buisvormige hendels met rubber handgreep.

Order nr.	Orig. nr.	Lengte mm	Capaciteit mm	Capaciteit mm	Lengte inch	Prijs €
101900108	BC414	379	6 (HRC15)	3 (HRC40)	15	35,90
101900207	BC418	485	8 (HRC15)	4 (HRC40)	18	39,90
101900306	BC424	652	10 (HRC15)	5 (HRC40)	24	55,90
101900405	BC430	800	13 (HRC15)	7 (HRC40)	30	73,90
101900504	BC436	958	16 (HRC15)	8 (HRC40)	36	95,90

TENGOOLS



Wisselmessen voor BC-boutenscharen.

Order nr.	Orig. nr.	Lengte mm	Capaciteit mm	Prijs €
101901007	BC414J	379	6	23,50
101901106	BC418J	485	8	31,00
101901205	BC424J	800	10	37,50
101901304	BC430J	800	13	51,50
101901403	BC436J	958	16	68,00

Buizensnijders

TENGOOLS



Buizensnijderset 6-delig : Bestaat uit buitensnijders voor koper en bronzen buizen 10, 12, 15 en 22mm, 3-22mm, ontbraamtoestel.

Order nr.	186400107
Orig. nr.	TTTC06
Buizensnijder	mm 10 - 12 - 15 - 22
Verstelbare buizensnijder	mm 3-22
Prijs	€ 72,90

TENGOOLS



Buizensnijder voor koper en bronzen buizen. Ideaal voor gebruik in smalle plaatsen.

Order nr.	Orig. nr.	Voor buisdiameter mm	Prijs €
173070103	TFA10	10	16,00
173070202	TFA12	12	16,50
173070301	TFA15	15	17,50
173070400	TFA22	22	20,50

TENGOOLS



5 Extra messen voor TFA10-TFA12-TFA15-TFA22.

Order nr.	173071002
Orig. nr.	TFA0252RK
Prijs	€ 15,90

TENGOOLS



Buizensnijder voor koper en bronzen buizen. Met een dun snijwiel en 2 begeleidingswielen. Intrekbare ruimer.

Order nr.	105910103
Orig. nr.	TF30
Voor buisdiameter	mm 3-32
Prijs	€ 24,90

TENGOOLS



Buizensnijder voor koper en bronzen buizen. Een dun snijwiel en 2 begeleidingswielen. De snijder heeft een constante lengte en is ideaal voor kleine werkomgevingen.

Order nr.	107540106
Orig. nr.	TF22
Voor buisdiameter	mm 3-22
Prijs	€ 10,50

TENGTTOOLS



Extra snijwielen voor buizensnijder TF30 en TF22.

Order nr.	107540205 ⓘ
Orig. nr.	TF2230RK
Prijs	€ 6,40

TENGTTOOLS



PVC Buizenontbramer.

Order nr.	173240300 ⓘ
Orig. nr.	DBT41
Voor buisdiameter	mm 3-41
Prijs	€ 10,50

TENGTTOOLS



Alu Buizenontbramer.

Order nr.	173240102 ⓘ	173240201 ⓘ
Orig. nr.	DBT35	DBT54
Voor buisdiameter	mm 8-35	10-54
Prijs	€ 61,50	71,90

TENGTTOOLS



Alu buizensnijder voor koper en aluminium.

Order nr.	173250101 ⓘ
Orig. nr.	TF76
Voor buisdiameter	mm 6-76
Prijs	€ 79,50

TENGTTOOLS



5 extra messen voor TF76.

Order nr.	173251006 ⓘ
Orig. nr.	TF76RK
Prijs	€ 43,90

TENGTTOOLS



Buizensnijder voor pvc en zacht plastic.

Order nr.	173410101 ⓘ
Orig. nr.	TFP01
Voor maximum buisdiameter	mm 42
Prijs	€ 49,50

TENGTTOOLS



Extra mes voor TFP01.

Order nr.	173410200 ⓘ
Orig. nr.	TFP01RK
Prijs	€ 14,90

TENGTTOOLS



Buizensnijder voor pvc.

Order nr.	173410309 ⓘ
Orig. nr.	TFP02
Voor maximum buisdiameter	mm 42
Prijs	€ 50,50

TENGTTOOLS



Extra mes voor TFP02.

Order nr.	173410408 ⓘ
Orig. nr.	TFP02RK
Prijs	€ 17,50

TENGTTOOLS



Buizensnijder 19-83mm. Om dunwandige roestvrij staal, koper en PVC-buizen te snijden, tot een dikte van 1.5mm. Selfsluitend en met éénhandsbediening. De instelmoer zorgt ervoor dat de buizensnijder gemakkelijk kan gebruikt worden voor herhalingsartikelen. 15 snijwielen.

Order nr.	186770103 ⓘ
Orig. nr.	TF300
Buizensnijder	mm 19-83
Prijs	€ 55,00



Kabelscharen

TENGTOLS



Kabel knipper.

Order nr.	160390100		
Orig. nr.		495	
Gerold staal	mm	250	
Roestvrij staal	mm	570	
Ontwerp		rechts	
Prijs	€	19,50	

TENGTOLS



Kabelknipper. Matrijsgesmeed. De chroom molydenium staal bladen zijn gehard om kanten te knippen. Knijpt koper en aluminium elektrische kabels tot 2AWG (14 mm²) diameter HRC 60-62.

Order nr.	144050101		
Orig. nr.		496	
Lengte	mm	250	
Snijcapaciteit	mm	12	
Maximum kabelgrootte	mm ²	14 (2AWG)	
Prijs	€	23,90	

Plaatscharen

TENGTOLS



Knipset bestaande uit 2 plaatscharen (recht/rechts (491) - recht/links (492)), een breekmes (701N), een schaar (497) en een extra-zwarte kabelknijptang (496 - 590mm). TTD-tray.

Order nr.	144020104		
Orig. nr.		TTDCT05	
Prijs	€	73,90	

TENGTOLS



Plaatschaar. Snijranden van molybdeen staal, inductie gehard tot HRC 60-62. Voor maximaal 1,5 mm koudgewalst plaatstaal. Kunststof handgrepen. Met terugspringveer en vergrendeling met éénhandsbediening.

Order nr.	186710109	186710208	186710307
Orig. nr.	490W	491W	492W
Lengte	mm	248	248
Ontwerp		Recht/Rechts	Recht/Links
Snijdikte metalen platen	mm	1,5	1,5
Snijcapaciteit roestvrij plaatstaal	mm	0,9	0,9
Snijcapaciteit koper	mm	1,8	1,8
Snijcapaciteit koudgewalst plaatstaal	mm	1,5	1,5
Prijs	€	19,90	19,90

TENGTOLS



Metaalschaar. Schaar uit geprofileerd metaal met kunststof handgrepen. De hoek tussen het mes en de hendel laat toe dat de hand boven het materiaal blijft bij het snijden. Met veer en sluitingshendel. Model voor recht en recht/links - recht/rechts knippen.

Order nr.	74160052	74160102	74160201
Orig. nr.	490	491	492
Lengte	mm	250	250
Ontwerp		recht	recht/rechts
Snijcapaciteit roestvrij metaal	mm	0,9	0,9
Snijcapaciteit plaatstaal	mm	1,5	1,5
Prijs	€	20,50	22,50

TENGOOLS



NEW
EXTRA KORT

Korte blikchaar uit gesmeed chroom-molybdeen staal. Gehard tot HRC 60-62. Samengestelde werking. Dankzij de hoek tussen de messen en het handgreep blijven de handen steeds boven het materiaal. Twee componenten handgreep. Met veer en vergrendelingshendel. Heel handig in gebruik.

Order nr.	74160011	74160029	74160037
Orig. nr.	494-7	491-7	493-7
Lengte	mm 185	190	185
Type	recht/links	recht	recht/rechts
Snijcapaciteit roestvrij plaatstaal	mm 0,9	0,9	0,9
Snijcapaciteit plaatstaal	mm 1,5	1,5	1,5
Prijs	€ 23,50	23,50	23,50

TENGOOLS



Metaalschaar. Schaar uit geperst profiel met kunststof handgrepen. De hoek tussen het mes en de hendel laat toe dat de hand boven het materiaal blijft bij het snijden. Met veer en sluitingshendel. Model voor ofwel rechts ofwel links knippen.

Order nr.	74160300	74160409
Orig. nr.	493	494
Lengte	mm 250	250
Ontwerp	rechts	links
Snijcapaciteit in roestvrijstaal	mm 0,9	0,9
Snijcapaciteit plaatstaal	mm 1,5	1,5
Prijs	€ 25,50	29,50

Scharen

TENGOOLS



Professionele schaar. Lengte 138mm. Blad in hoogwaardig roestvrij staal. Nylon handvat met 30% glasvezel.

Order nr.	144140100
Orig. nr.	497
Lengte	mm 138
Bladlengte	mm 42
Capaciteit zachte kabel	mm 22
Prijs	€ 25,90

TENGOOLS



SR1160

SR1180



SR2180

SR3160

Schaar. Roestvrij speciaal staal. Warm gesmeed. Matte afwerking. Voor het snijden van elektronische stukken, printplaten.

Order nr.	Orig. nr.	Lengte mm	Type punten	Prijs €
177920105	SR1160	160	scherp recht	20,50
177920204	SR1180	180	scherp recht	23,50
177920303	SR2180	180	afgerond recht	23,50
177920402	SR3160	160	scherp gebogen	21,90

TENGOOLS



Zelfsluitende tang. Speciaal roestvrij staal. Warm gesmeed. Matte afwerking. 3 stappen vergrendeling. Gegroefd.

Order nr.	Orig. nr.	Lengte mm	Type	Prijs €
177930104	SLP1160	160	recht	19,50
177930203	SLP2180	180	recht	21,50
177930302	SLP3160	160	gebogen	19,50
177930401	SLP3180	180	gebogen	28,50

TENGOOLS



TW1180

TW2125



TW2160

TW2180

Pincet. Roestvrij speciaal staal. Warm gesmeed. Matte afwerking.

Order nr.	Orig. nr.	Lengte mm	Type	Prijs €
177910205	TW1160	160	Recht, gegroefd	11,50
177910304	TW1180	180	Recht, gegroefd	12,50
177910403	TW2125	125	Gebogen, gegroefd	12,90
177910502	TW2160	160	Gebogen, glad	29,50
177910601	TW2180	170	Zvorm, naaldpunten	29,50

Kwaliteit voor je geld

Ook treinen worden hersteld met Teng Tools

Het succesverhaal van Teng Tools gaat verder in Europa. Het laatste voorbeeld van klanttevredenheid komt uit Ierland, in de onderhoudsdienst van de Spoorwegen.

“Voor ons biedt Teng Tools een uitstekende prijs/kwaliteit verhouding. De werktuigen zijn winstgevend en betrouwbaar, en we hebben nog nooit problemen gehad met gebroken of slecht werkende werktuigen” zegt de onderhoudsverantwoordelijke in Drogheda, in het graafschap van Louth.

De Ierse Spoorwegen beschikken over een onderhoudsdienst voor het nationale netwerk bestaande uit 7 onderhoudscentra, waarvan 69 personen tewerk gesteld zijn in Drogheda.

Om hun werk uit te voeren, beschikken de werknemers over



20

40 Teng Tools gereedschapssets, met onder andere doppen, ratels en sleutels, inbus-sleutels, schroevendraaiers en tangen.

“We zien geen enkele reden om te veranderen, daar we tot nu toe geen defect of incident vastgesteld hebben. Het personeel is tevreden over de uitrusting, en de technische ondersteuning is goed.” verklaart de onderhoudsverantwoordelijke.

“De Teng Tools producten worden getest en gecontroleerd, en we hebben een echte vertrouwensrelatie tussen het centrum en Teng Tools” concludeert hij.



Vijlen

TENGOOLS



Set van 12 naaldvijlen met de meeste courante modellen. TC-tray. Lengte 163mm.

Order nr.	128430105
Orig. nr.	TTNF12
Prijs	€ 28,50

TENGOOLS



Set van 5 handvijlen L. 250mm middelgrof bestaande uit 1 ronde, 1 halfronde, 1 vierkante, 1 driehoek en 1 platte handvijl. TTX Tray.

Order nr.	128440104
Orig. nr.	TTXF05
Prijs	€ 43,90

TENGOOLS



Platte handvijl met twee vijlkanten, middel grof, lengte : 250 mm.

Order nr.	128400108
Orig. nr.	FLFT10
Prijs	€ 10,50

TENGOOLS



Platte handvijl met twee vijlkanten, middelgrof, lengte : 250 mm.

Order nr.	128490109
Orig. nr.	FLHF10
Prijs	€ 10,50

TENGOOLS



Handvijl met twee vijlkanten (rond en plat), middelgrof, lengte: 250 mm.

Order nr.	128520103
Orig. nr.	FLHR10
Prijs	€ 11,50

TENGOOLS



Ronde handvijl. Lengte 250 mm (middelgrof).

Order nr.	128530102
Orig. nr.	FLRD10
Prijs	€ 10,00

TENGOOLS



Vierkante handvijl. Lengte : 250 mm (middelgrof).

Order nr.	128540101
Orig. nr.	FLSQ10
Prijs	€ 9,90

TENGOOLS



Driehoekige handvijl, lengte: 250 mm (middelgrof).

Order nr.	128550100
Orig. nr.	FLTR10
Prijs	€ 10,50

Smeergereedschap

METALWORKS



Kunststof oliekan 215 ml. Met schaal in ml en oz. Het ledigen van het reservoir gebeurt door samendrukken van de flexibele kunststof kan. Geleverd met vaste tuit met anti-drup tip.

Order nr.	724600215		
Orig. nr.	OKK215		
Capaciteit	ml	215	
Prijs	€	4,50	

METALWORKS



Oliekannen met stalen reservoir en messing pomp. Geleverd met rechte en flexibele tuit.

Order nr.	724603000	724605000
Orig. nr.	OK300	OK500
Capaciteit	ml 300	500
Prijs	€ 8,10	9,50

METALWORKS



Schenkkkan PE wit.

Order nr.	724575010	724575050	724576060
Orig. nr.	OKS1	OKS5	OKS6
Capaciteit	l 1	5	6
Prijs	€ 5,70	13,90	15,90

METALWORKS



Kunststof PE trechter. Schaalverdeling in lt. Met flexibele tuit.

OTR220 voorzien van adaptor, geschikt voor vaten.

Order nr.	724575180	724575220
Orig. nr.	OTR180	OTR220
Capaciteit	ml 180	220
Prijs	€ 8,60	10,90

METALWORKS



Bijvulapparaat voor vet. Voor een 20 liter tank.

Order nr.	724302020		
Orig. nr.	GRSVP20		
Diameter	mm	450	
Prijs	€	47,50	

METALWORKS



Industriële vetpuit met capaciteit 500 ml. Werkt met standaard 400cc vetpatronen of met vet in bulk. Met draadaansluiting en verwisselbare vulnippel, ontluchnippel, vaste spuitpijp MCOX1, M10x1 smeernippel 4-klawven en flexibel. Hoge druk 690 bars. Zwart gelakte uitvoering.

Order nr.	724574040		
Orig. nr.	GRSP100FV		
Capaciteit	ml	500	
Druk	bar	690	
Prijs	€	23,50	

METALWORKS



Vetspuit met een capaciteit van 400 ml, inclusief flexibel. Kan met bulk of patroonvulling gebruikt worden. Voorzien van draadaansluiting.

Order nr.	724571110		
Orig. nr.	GRSPP100		
Capaciteit	ml	400	
Prijs	€	19,00	



Pneumatische vetspuit voor aansluiting op compressor. Werkt met standaard 400cc vetpatronen of met vet in bulk tot 480. Met vaste tuit en flexibele slang, smeernippel en manuele handpomp voor het geval er geen luchtdruk voorhanden is.

Order nr.	712102230		
Orig. nr.	2102230		
Werkdruk	bar	2-8	
Luchtverbruik	l/slag	0,4	
Drukvermogen	1:50		
Prijs	€	37,00	



Universeel smeervet. Geschikt voor smering van medium tot zwaar belaste rollagers of waar smering met Lithium type vet EP 2 is voorgeschreven. Bruikbaar bij temperaturen tussen -30° en +120°C voor alle mogelijke door SKF-voorgeschreven snelheden. Universeel vet met prima anti-corrosie eigenschappen, waterafscheidend en mechanisch stabiel.

Order nr.	155560204	155560303
Orig. nr.	UNIGREST2-400G	UNIGREST2-1
Viscositeit bij 40°C	mm ² /s 200	200
Viscositeit bij 100°C	mm ² /s 16	16
Inhoud	kg 0,4	1,0
Verpakking	cartridge	
Prijs	€	5,80
		19,90



Universeel smeervet. Geschikt voor toepassingen bij hoge temperatuur. Goede weerstand tegen water.

Order nr.	155580103	
Orig. nr.	UNIGRE EX 25-400G	
Viscositeit bij 40°C	mm ² /s	200
Inhoud	kg	0,4
Prijs	€	6,90



Flexibele slang voor handbediende en/of pneumatisch bediende smeerpompen. Lengte 300mm. Max. werkdruk 400 bar.

Order nr.	724573330	
Orig. nr.	GRSPFP300	
Aansluiting	M	10x1
Prijs	€	10,00



Vaste spuitpijp.

Order nr.	725473061	725473060
Orig. nr.	GRSSPUI15	GRSSPUI25
Lengte	mm 150	250
Maat	M 10x1	10x1
Prijs	€	3,10
		4,20



Smeernippel 4 klauw. Voor types GRSP100, GRSP100 en GRSP100.

Order nr.	724574180	
Orig. nr.	GRSPK418	
Type	EU	
Aansluiting	M	10x1
Prijs	€	4,20



Vulnippel voor vetpomp.

Order nr.	724551010	
Orig. nr.	GRBLV/01/M	
Aansluiting	M	10x1
Prijs	€	3,60



Assortiment van 110 smeernippels van de meeste gangbare afmetingen.

Order nr.	161800406	
Orig. nr.	TT01T110	
Aantal stuks	110	
Smeernippels	M	30 st. 6x1 - recht, 20 st. 6x1 - 90° gebogen,
		20 st. 8x1 - recht, 10 st. 8x1 - 90° gebogen,
		20 st. 10x1 - recht, 10 st. 10x1 - 90° gebogen
Prijs	€	36,90

METALWORKS



Oliezuigpomp voor bvb transmissieoliën. Cap. 500 cc Geleverd met een flexibele vinyl leiding L. 300mm . Voor gebruik met niet-corrosieve vloeistoffen.

Order nr.	724571010 ⓘ	
Orig. nr.	GRSOZ100	
Capaciteit	ml	500
Prijs	€	14,00

METALWORKS



Transferpomp. Zuigt en stuwt de vloeistof in 1 beweging. Eenvoudig en veilig overbrengen van vloeistoffen, zeker in geval van onveilige of delicate vloeistoffen. Alumium behuizing en componenten met viton dichting. Geleverd met 2 x 120cm vinyl leiding. Aanbevolen voor synthetische, minerale, biologische oliën, diesel, koelvloeistoffen, water, anti-vries en remvloeistoffen.

Order nr.	724573020 ⓘ	
Orig. nr.	GRSOZ200	
Capaciteit	ml	350
Prijs	€	25,50

METALWORKS



Pomphouder. Voor de verschillende types smeerpompen.

Order nr.	724552020 ⓘ	
Orig. nr.	GRGGH01	
Prijs	€	7,40

VLOEISTOFFAFZUIGER

p.404



METALWORKS



Nylon PP chemikaliën pomp. Verticaal model. Voornamelijk gemaakt voor gebruik met thinners en koelvloeistoffen. Nylon constructie met roestvrijstalen zuiger en PTFE dichtingen. Met 2" adaptor voor 50 en 200 l vaten. Geschikt voor verfthinners, acetone, anti-vries, remvloeisstof, remcleaner, detergents, glycerine, water, onkruidverdelger, lichte zuren, benzine, enz. Niet geschikt voor sterke zuren, bleekwater, diesel, enz. Cap. 400 ml per stroke.

Order nr.	724573025 ⓘ	
Orig. nr.	PPKW25	
Prijs	€	42,50

METALWORKS



Rotatieve chemikaliën pomp. Wordt gebruikt waar in normale gevallen een gietijzeren of metalen pomp niet kan worden gebruikt. De behuizing bestaat uit een glasvezel PP met Rytan versterkingen. Alle dichtingen zijn van Viton rubber en alle onderdelen zijn van roestvrij staal. Een zeef op het uiteinde van de aanzuigpijp verhindert vervuiling van de vloeistoffen. Geleverd met PP aanzuigpijp en 2" adaptor voor 50 en 200 l vaten. Geschikt voor op water gebaseerde vloeistoffen, zuren, anti-vries, chemikaliën en alle met benzine relateerde vloeistoffen. Niet geschikt voor acetone, lakken, minerale olië'n, solventen, terpentijn enz. Cap. 5 l per 20 omwentelingen.

Order nr.	724573035 ⓘ	
Orig. nr.	PPKW35	
Prijs	€	67,50

METALWORKS



Rotatieve hevelpomp voor vaten tot 200l. aansluiting 2". Behuizing in gietijzer. Geschikt voor niet-corrosieve vloeistoffen en olie met hoge viscositeit. Cap. lift : 130 cm Debiet 28 lt/min.

Order nr.	754773030
Orig. nr.	PPKW30
Capaciteit	l/min 28
Prijs	€ 25,50

METALWORKS



De populaire universele hevelpomp. Kan gebruikt worden op vaten met 1 1/2" en 2" opening. Rubber handvat op de hendel voor een vlot gebruik. Met gebogen metalen tuit en een telescopische aanzuigpijp voor gebruik in 50 en 200 lt vaten. Geschikt voor op olie gebaseerde vloeistoffen, motor oliën, diesel. De afdichtingsring is NBR. Niet geschikt voor gebruik met water, solventen, zuren, anti-vries, benzine enz. Cap. 300ml/stroke.

Order nr.	724573040
Orig. nr.	PPKW40
Prijs	€ 30,50

METALWORKS



Topkwaliteit membraampomp met dubbel diafragma. Industriëel model met zeer hoog debiet : 800 ml per pompbeweging. Ideaal voor gebruik waar geen gebruik kan worden gemaakt van luchtdruk of andere motorische of elektrische krachtbron. Roestvrijstalen zuiger en diesel resistent nitril-rubber membraam. Geleverd met 2" adaptor geschikt voor 50 en 200 l vaten. Met een hangslot afsluitbare hendel. Met aanzuigdarm met anti-terugslag klep. Afvoerdarm L. 240cm in anti-statisch neoprene rubber die handig kan worden opgehangen in een ingebouwde 'neushouder' op de pomp. Geschikt voor diesel, brandstofdiesel, motorolie en andere lichtere oliën en petroleumproducten. Niet geschikt voor corrosieve vloeistoffen, solventen, zuren, benzine, enz.

Opmerking. Brandstoffen met ethanol kunnen aanleiding geven tot meer frequent vervanging van de rubber onderdelen. Gebruik de pomp nooit in de omgeving van vuur of vonken omwille van een eventueel explosie gevaar. Deze pomp is geconciëerd voor vloeistoffen met een lagere viscositeit. Het pompen met zwaardere vloeistoffen kan aanleiding geven tot overdadige slijtage.

Order nr.	724573055
Orig. nr.	PPKW55
Prijs	€ 121,00

METALWORKS



Hevelpomp. Eenvoudig te bedienen. Pompt vloeistoffen automatisch naar lagere reservoirs, en met handbediening ook naar hogere reservoirs. Geschikt voor vloeistoffen op waterbasis, detergents.

Order nr.	724570010	724570011
Orig. nr.	PPKW10	PPKW11
Debiet	l/m 6,5	17,5
Aansluiting	inch 1 - 1/2	2
Voor type	l 5 - 20	50 - 200
Lengte	mm 533	1125
Lengte zuigslang	mm 387	839
Interne diameter	mm 14	18
Buitendiameter	mm 16	22
Prijs	€ 6,40	15,00

Automotive tools

TENGOOLS

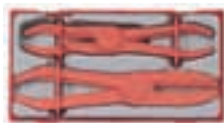

Set van 3 speciale klemtangen voor het onbeschadigd samenklemen van o.a. remleidingen. Lichte constructie. Toepasbaar voor de meest gangbare leidingen. TC-tray.

Order nr.	118420108		
Orig. nr.	TTHC03		
Aantal stuks	3		
Voor slang diameter	mm	10 - 15 - 30	
Type gereedschap	automotive set		
Prijs	€	27,50	

TENGOOLS



Speciaal ontworpen klemtangen met bekken die de samengeperste flexibel niet beschadigen. Lichtgewicht en gemaakt in product-neutraal materiaal. 3 maten toepasbaar voor de meest gangbare leidingen.

Order nr.	117730101	117730200	117730309	
Orig. nr.	AT080	AT085	AT090	
Voor slang diameter	mm	10	15	30
Prijs	€	11,90	13,50	18,50

TENGOOLS



Extra lange bektang L.275mm. Voor diepe, moeilijk bereikbare plaatsjes. Hardheid lichaam HRC43-48. Hardheid tips HRC34.

Order nr.	144080108		
Orig. nr.	AT096		
Type	recht		
Prijs	€	21,50	

TENGOOLS



Extra lange bektang L. 275mm 45° gebogen. Voor diepe, moeilijk bereikbare plaatsjes. Hardheid lichaam HRC43-48. Hardheid tips HRC34.

Order nr.	144080207		
Orig. nr.	AT097		
Type	45° gebogen		
Prijs	€	21,50	

TENGOOLS



Extra lange bektang L.275mm voor fixatie van leidingen. Voor diepe, moeilijk bereikbare plaatsjes. Hardheid lichaam HRC43-48. Hardheid tips HRC34.

Order nr.	144080306	144080405	
Orig. nr.	AT098	AT099	
Voor leiding	inch	5/16	1/2
Prijs	€	20,50	20,50

TENGOOLS



Draadvergrendeltang. Gebruikt om moeren te vergrendelen, sluitingen of dergelijke met behulp van draad. Zijknijptangen en een kleine kop voor een goede bereikbaarheid. De tang grijpt de draad en de achterste knop draait dan de draad rond. Zwart.

Order nr.	131490105	
Orig. nr.	AT605	
Prijs	€	44,90

TENGOOLS



Poulieborgsleutel gebruikt als hulpmiddel bij de montage en demontage van geribde riempoulies. Ook voor gebruik op de krukas bij het afstellen van de motor en voor montage en demontage van olie- en brandstoffilters.

Order nr.	117970103	
Orig. nr.	AT055	
Prijs	€	49,90

TENGOOLS



Klepsteeldichttang met lange uiteinden om gemakkelijk klepsteeldichtingen te passen. Lengte 280mm.

Order nr.	118010107	118010206	
Orig. nr.	AT025	AT030	
Type	gebogen	recht	
Prijs	€	29,00	27,50

TENGOOLS



Schraper voor cilinderring groeven geleverd met vijf geharde mesjes voor verschillende cilinderring-wijdtes. Instelbaar naargelang de diameter. Gesatineerde afwerking.

Order nr.	118190107		
Orig. nr.	AT022		
Aanpasbare diameter	mm	50-175	
Mesbreedtes	mm	2,0, 3,0, 4,0, 5,0, 5,5	
Prijs	€	49,50	

TENGOOLS



Montagepen voor het monteren en demonteren van ringen. Met veer-systeem en magnetisch einde voor het opnemen van verloren ringen.

Order nr.	118000108	
Orig. nr.	AT035	
Prijs	€	16,50

TENGOOLS



Tang voor het snel afnemen van de bougiekap. Met plastic bedekte handvaten en terugkeerveer. Gemaakt voor een demontage zonder schade aan de kabels.

Order nr.	69150100
Orig. nr.	SPBP20
Prijs	€ 20,90

TENGOOLS



Multifunctionele tang met een verstelbare opening van 53 tot 118 mm. Chroom vanadium staal, geharde, vernikkelde en gesmede klauwen. Zelfsluitend met snelontkoppeling.

Order nr.	117780106
Orig. nr.	409
Aanpasbare hoogte	mm 53-118
Prijs	€ 22,50

TENGOOLS



Filtersleutel voor het aan- en afschroeven van oliefilters tot diameter 230mm Met chroom vanadium handvat.

Order nr.	112310305
Orig. nr.	9123
Opening	mm 160
Prijs	€ 36,50

TENGOOLS



Vervangband voor filtersleutel 9123.

Order nr.	112310404
Orig. nr.	9123RK
Prijs	€ 7,60

TENGOOLS



Filtersleutel voor het aan- en afschroeven van oliefilters tot diameter 130mm. Met nylon band en 1/2" vierkant aansluiting.

Order nr.	112310107
Orig. nr.	9110
Aansluiting	inch 1/2
Opening	mm 130
Prijs	€ 9,90

TENGOOLS



Nylon vervangband voor filtersleutel 9110.

Order nr.	112310156
Orig. nr.	9110RK
Prijs	€ 3,90

TENGOOLS



Filtersleutel voor het aan- en afschroeven van oliefilters tot diameter 120mm. Met ketting en 1/2" vierkant aansluiting.

Order nr.	112310206
Orig. nr.	9120
Aansluiting	inch 1/2
Opening	mm 120
Prijs	€ 9,80

TENGOOLS



Vervangketting voor filtersleutel 9120.

Order nr.	112310255
Orig. nr.	9120RK
Accessoire	vervangketting
Prijs	€ 5,90

TENGOOLS



16-delige universele olieserviceset bestaande uit 6 dubbele carterdoppen, 2 bougiedoppen 3/8", 1 oliefiltersleutel, 2 verlengstukken 3/8" L. 75 en 200mm, 1 adaptor 1/2"-3/8", 1 dop 3/8" 21mm, 1 telescopische inspectiespiegel met magneet en een set voelermaten. TC-tray.

Order nr.	03960101
Orig. nr.	TIOS16
Aantal stuks	16
Maat carterdoppen	mm/pouce 5/16x3/8 - 11x12 - 17x1/2 - 8x3/8 - 8x10 - 13x14
Bougiedoppen 3/8"	mm 16 - 21
Verlengstukken 3/8"	mm 75 - 250
Voelermaat, 21 bladen	mm 0,05 - 1,00
Type gereedschap	automotive set
Prijs	€ 59,90

TENGOOLS



Tang voor brandstofkoppelingen. Geschikt voor brandstofkoppelingen voor de meeste wagens.

Order nr.	117890103	117890301
Orig. nr.	AT150	AT156
Voor brandstofleiding	mm 8	-
Prijs	€ 12,50	12,50

TENGOOLS



2 in 1. Geschikt voor grote en kleine remschoenreinigers.

Order nr.	118090109
Orig. nr.	AT160
Prijs	€ 11,90

TENGTOLS



Hoeksleutel speciaal ontworpen voor het afstellen van schokdempers op motorfietsen.

Order nr.	132220104
Orig. nr.	HP301
Voor diameter	mm 65 - 70
Prijs	€ 8,20

TENGTOLS



Multi-functionele tang voor het aanbrengen van balanceergewichten op de wielen. Met terugtrekveer.

Order nr.	117920108
Orig. nr.	AT215
Prijs	€ 33,50

TENGTOLS



11-delige set bestaande uit 5 linkse tappen, 4 moeren-extracteurs en 2 moersplijters. TC-tray.

Order nr.	69340107
Orig. nr.	TTSN11
Linkse tappen	inch 7/64 - 9/64 - 5/32 - 1/4 - 19/64
Extractors	mm 6 - 8 - 10 - 12
Moersplijters	mm 5-20, 14-27
Prijs	€ 61,50

TENGTOLS



5-delige extractorset met linkse spiraal. Voor extractie van gebroken schroeven en bouten. Geleverd in een plasticen doos.

Order nr.	116930108
Orig. nr.	SE05
Aantal stuks	5
Voor schroef	M6 - M20
Voor slagbit	mm 2,8, 3,5, 4,0, 6,35, 7,5
Prijs	€ 14,50

METALWORK



NEW
FIJNE SPOED

Set draadeindhalters "Out-you-Come" N°1-N°6.

Set draadeind uithalers, hoog carbon staal, **nummers 1 tot 6**, met een bereik van M3 tot M24. spiraalvormig, fijne spoed, linkse draad, voor het verwijderen van bouten en schroeven.

Iedereen heeft wel al eens verveeld gezeten met een doorgedraaide schroef of een afgebroken bout. Wat dan? Met de "Out-you-Come" draadeind uithalers bieden wij hiervoor de oplossing. De schroef of bout wordt eerst precies op de geschikte diameter voor de draadeind uithaler geboord. Vervolgens brengt u de uithaler in het gat en draait u tegen wijzerzin met behulp van een wringijzer, deze worden eveneens verkocht op onze website. De spiralen boren zich vervolgens een weg in de schroef of bout, door de linkse draad en de rechtse draai beweging met het wringijzer, verwijdert u vervolgens de bout of schroef.

Order nr.	748529000
Orig. nr.	DEU16
Prijs	€ 12,90

TENGTOLS



5-delige extractorset. Voor extractie van schroeven, bouten, tapeinden. Glad vierkant einde. HRC 50-52.

Order nr.	172270100
Orig. nr.	TMSE05S
Voor boorgaten	mm 3 - 4 - 5 - 7 - 9
Prijs	€ 19,50

TENGTOLS



Aparte schroef extractors. Voor extractie van schroeven, bouten, tapeinden. Glad vierkant einde. Gehard tot HRC 50-52.

Order nr.	Orig. nr.	Voor boorgaten mm	Prijs €
151460102	SELO1S	3 (1/8")	2,90
151460201	SELO2S	4 (3/16")	3,10
151460300	SELO3S	5 (15/64")	4,30
151460409	SELO4S	7 (5/16")	5,00
151460508	SELO5S	9 (3/8")	5,60

TENGOOLS



Set van twee moersplijters. Gemakkelijk splijten van gebroken of geroeste moeren zonder het beschadigen van de bout of draad.

Order nr.	116950106 T		
Orig. nr.	NS02		
Opening	mm	5,20, 14,27	
Voor noten	M	M2,5-12, 8-18	
Prijs	€	27,90	

TENGOOLS



Extractie-doppen met 6-kant aansluiting einde en 1/2"-aansluiting. Geschikt voor het verwijderen van blinde schroefdraad.

Order nr.	Orig. nr.	Capaciteit mm	Aansluiting inch	Prijs €
116960105 T	ST12506	6	1/2	13,50
116960204 T	ST12508	8	1/2	15,50
116960303 T	ST12510	10	1/2	17,50
116960402 T	ST12512	12	1/2	18,50

TENGOOLS



Stanguittrekker voor het in- en uitdraaien van stangen. De stang wordt excentrisch geklemd door het aanspannen van het gekarteld wiel van de trekker. Aansluiting 1/2".

Order nr.	116970104 T		
Orig. nr.	2300		
Voor schroef diameter	mm	5,5-19	
Prijs	€	29,50	

TENGOOLS



Speciale automotive doppen. Chroom vanadium staal. Gesatineerd.

Order nr.	Orig. nr.	Aansluiting inch	Maat	Omschrijving	Prijs €
128670106 T	AT350	1/2"	29 mm	Lambda-sonde	25,50
128670205 T	AT355	3/8"	22 mm	Lambda-sonde	17,50
128680105 T	AT360	1/2"	27 mm	verstuivers van dieselmotoren	19,50
128690104 T	AT365	3/8"	7/8"	Lambda-sonde	17,50
128700101 T	AT370	3/8"	1 1/16"	oliedrukregelaar	14,50
128710100 T	AT375	1/2"	7/8"	Lambda-sonde	18,50
128720109 T	AT380	3/8"	7/8"	Lambda-sonde	19,50

TENGOOLS



Torsiestaafset in TC-tray. Voor het vastzetten van wielmoeren. Bevat 4 torsiestaven variërend van 90-140 Nm, 1 adaptor en 3 slagdoppen voorzien van een kunststof beschermingshuls voor gebruik bij o.a. alu-velgen.

Order nr.	172470403 T		
Orig. nr.	TTTS08		
Bitsen 1/2"	mm	17-19-21	
Adaptor	inch	3/8 x 1/2	
Verlengstukken	Nm	1/2" 90-110-120-140	
Prijs	€	77,90	

TENGOOLS



Torsiestaaf. Voor het vastzetten van wielmoeren met slagmoeraanzetters.

Order nr.	Orig. nr.	Voor moer Nm	Kant inch	Prijs €
172510109 T	923090	90	1/2	17,50
172510208 T	923110	110	1/2	17,50
172510307 T	923120	120	1/2	17,50
172510406 T	923140	140	1/2	17,50

TENGOOLS



Buizenklemtang. Met een telescopische as in chroom die regelbaar is in 4 standen. Speciaal geschikt voor in moeilijk bereikbare plaatsen.

Order nr.	173030107 T		
Orig. nr.	BWT406		
Capaciteit	mm	32-48	
Maximum lengte	mm	400	
Prijs	€	21,50	

TENGOOLS



Kettingsleutel - voor buizen.

Order nr.	173230103 T		
Orig. nr.	9124		
Capaciteit, buizen	inch	4	
Prijs	€	36,50	

METALWORKS



Set van 2 zuignappen. Kunststof lichaam met rubber zuignappen. Geleverd met sjorband.

Order nr.	754759999 T		
Orig. nr.	CAT999K		
Capaciteit	kg	+/- 80	
Prijs	€	68,00	

Borstels

METALWORKS



Handborstel met 4-rijige staaldraad en kunststof handgreep. Borstellengte 140mm. Totale lengte 245mm. Ook verkrijgbaar in display.

Order nr.	724581040	724581050
Orig. nr.	HA4521343008	HA452134D24
VE	1	24
Prijs/VE	€ 2,48	55,50

METALWORKS



Handborstel met 4-rijige roestvrijstaal draad en kunststof handgreep. Borstellengte 140mm. Totale lengte 245mm. Ook verkrijgbaar in display.

Order nr.	724581060	724581070
Orig. nr.	HA4523343008	HA452334D24
VE	1	24
Prijs/VE	€ 3,83	85,50

METALWORKS



Handborstel met 1-rijige messing coated staaldraad en kunststof handgreep. Borstellengte 140mm. Totale lengte 245mm. Ook verkrijgbaar in display.

Order nr.	724581080	724581090
Orig. nr.	HA4620913008	HA462091D24
VE	1	24
Prijs/VE	€ 2,48	53,50

METALWORKS



Handborstel met 1-rijige roestvrijstaal draad en kunststof handgreep. Borstellengte 140mm. Totale lengte 245mm. Ook verkrijgbaar in display.

Order nr.	724581100	724581110
Orig. nr.	HA4623913008	HA462391D24
VE	1	24
Prijs/VE	€ 5,70	118,00

METALWORKS



Handborstel met 1-rijige PPDraad en kunststof handgreep. Borstellengte 140mm. Totale lengte 245mm. Ook verkrijgbaar in display.

Order nr.	724581120	724581130
Orig. nr.	HA4628913008	HA462891D24
VE	1	24
Prijs/VE	€ 2,59	52,90

METALWORKS



Nylon borstel op stift - op blister. Wielmodel.

Order nr.	724581230	
Orig. nr.	HA6002919009	
Diameter	mm	50
Asgat	mm	6
Toerental	tpm	4500
VE	1	
Min. bestelhoeveelheid	5	
Prijs/VE	€	3,61

METALWORKS



Komborstel. Nylon borstel op stift - op blister.

Order nr.	724581260	724581270	
Orig. nr.	HA6008919009	HA6009919009	
Diameter	mm	50	60
Asgat	mm	6	6
Toerental	tpm	4500	4500
VE	1	1	
Min. bestelhoeveelheid	5	5	
Prijs/VE	€ 4,84	4,84	

METALWORKS



Komborstel. Geharde staaldraad 0,50 mm - getordeerd. DIN 68347.

Order nr.	724581310	
Orig. nr.	HA6081563008	
Diameter	mm	125
Toerental	tpm	6500
Hoogte borstel (T)	mm	24
Draad	M	14x2,00
Draadbundels	32	
VE	1	
Min. bestelhoeveelheid	5	
Prijs/VE	€	16,50

METALWORKS



Rondborstels voor slijpmachines QSM en SM. Geleverd met flensringen 12.7mm, 15.887mm, 19.05mm, 22.225mm en 25.4mm.

Order nr.	724581180	724581190	724581195	
Orig. nr.	HA5440623008	HA5660623008	HA5760623008	
Diameter	mm	150	200	250
Asgat	mm	32	32	32
Voor type	QSM 150	QSM 200/SM 200	SM 250 (vario)	
Prijs	€ 6,30	8,80	12,00	

METALWORKS



Batterijklem-kuiser. Geleverd in blister. Lengte: 85mm.

Order nr.	724581140	
Orig. nr.	HA4931003108	
VE	1	
Min. bestelhoeveelheid	5	
Prijs/VE	€	2,48

Magneten

TENGOOLS



Rail L. 457mm met 6 individuele magneten. Capaciteit van elke individuele magneet 450 gr. Kan bvb aan een gereedschapswagen worden bevestigd.

Order nr.	03450202 T		
Orig. nr.	TCMAG		
Gewicht	kg	0,60	
Afmetingen (l x b x h)	mm	457 x 52 x 17	
Prijs	€	30,50	

TENGOOLS

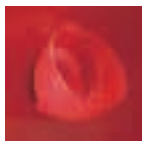

PVC kom met een sterke magneet voor bevestiging aan gereedschapswagens, gereedschap paneel, ...

Order nr.	174610204 T		
Orig. nr.	580R		
Diameter	mm	150	
Gewicht	kg	0,37	
Afmetingen (l x b x h)	mm	160 x 150 x 130	
Prijs	€	15,90	

METALWORKS



Set van 4 lasmagneten waarvan 2 magneten 85x120mm en 2 magneten 100x160mm. Met 45, 90 en 135° hoek.

Order nr.	801105750 E		
Orig. nr.	MAGS4		
Breedte	mm	85x200 en 100x60	
Magnetische draagkracht	kg	11 en 25	
Gewicht	kg	1,80	
Prijs	€	23,50	

TENGOOLS



Magneet voor het vasthouden van plat of rond staal bij het lassen of monteren. Met 90° en 45° hoek. Niet geschikt om te gebruiken vlakbij het te verlaten gedeelte. Magnetisme kan de lasstroom beïnvloeden.

Order nr.	37300100 T	37300209 T
Orig. nr.	MH75	MH90
Breedte	mm	120
Hoogte	mm	82
Magnetische draagkracht	ca N	27
Gewicht	kg	0,30
Afmetingen (l x b x h)	mm	16 x 133 x 205
Prijs	€	10,50

TENGOOLS



Roestvrijstalen schotel met 1 ronde magneet ingebouwd aan de onderkant. Deze onderkant is voorzien van een beschermende laag om schade aan bvb het wagenoppervlak te vermijden. Een prima werkinstrument om kleine zaken zoals schroeven, bouten, moeren e.d. samen te houden. Kan ook omgekeerd en zijdelings worden gebruikt. Rond model diam. 150mm.

Order nr.	15610108 T		
Orig. nr.	580		
Diameter	mm	150	
Gewicht	kg	0,38	
Afmetingen (l x b x h)	mm	157 x 42 x 157	
Prijs	€	13,90	

TENGOOLS



Roestvrijstalen schotel met 2 ronde magneten ingebouwd aan de onderkant. Deze onderkant is voorzien van een beschermende laag om schade aan bvb het wagenoppervlak te vermijden. Een prima werkinstrument om kleine zaken zoals schroeven, bouten, moeren e.d. samen te houden. Kan ook omgekeerd en zijdelings worden gebruikt. Rechthoekig model 320x150mm.

Order nr.	118470103 T		
Orig. nr.	580A		
Gewicht	kg	0,87	
Afmetingen (l x b x h)	mm	325 x 150 x 70	
Prijs	€	27,90	

TENGOOLS

NEW



Vierkante magnetische schotel 295x270mm. Grote magnetische roestvrijstalen schotel met 4 magneten met kunststof bedekt om de lak van de wagen niet te beschadigen.

Order nr.	186870101 T		
Orig. nr.	580S		
Gewicht	kg	1,00	
Afmetingen (l x b x h)	mm	295 x 270 x 42	
Prijs	€	37,90	

TENGOOLS



Telescopische controle-spiegel met een krachtige magneet en pen. Met pocket-clip. Ook verkrijgbaar in display.

Order nr.	35680107 ^T	801100167 ^T
Orig. nr.	582MI	582OMI
Diameter magneet	mm 6	-
Diameter spiegel	mm 32	-
Lengte minimum/maximum	mm 230 - 570	-
Sets in display	-	20
Gewicht	kg 0,04	2,00
Afmetingen (l x b x h)	mm 8 x 32 x 230	-
Prijs	€ 19,50	252,00

TENGOOLS



Magnetische pick-up pen met schrijfpunten aan het andere uiteinde. Kan tot 540mm lengte worden uitgeschoven. Ideaal om metalen componenten op te pikken. Met pocket-clip. Ook verkrijgbaar in display.

Order nr.	04200101 ^T	801100166 ^T
Orig. nr.	585MP	585OMP
Diameter magneet	mm 6	-
Lengte minimum/maximum	mm 135 - 540	-
Sets in display	-	50
Gewicht	kg 0,04	2,00
Afmetingen (l x b x h)	mm 13 x 13 x 135	-
Prijs	€ 10,90	314,00

TENGOOLS



8-delige inspectieset bestaande uit telescopische pick-up werktuigen zoals 1 flexibele klauw en 1 telescopische pick up, 1 inspectiespiegel, 1 vergrootglas, 1 LED lamp model 585. Geleverd met 2 batterijen. TC-tray.

Order nr.	144370103 ^T
Orig. nr.	TTTT08
Lengte flexibele pickup	mm 310
Lengte telescopische pickup	mm 160-480
Gewicht	kg 0,81
Afmetingen (l x b x h)	mm 265 x 142 x 50
Prijs	€ 49,90

TENGOOLS



Telescopische magnetische pick-up met een krachtige magneet, neemt magnetische componenten op in moeilijk te bereiken plaatsen. Plastieken handvat.

Order nr.	116790106 ^T
Orig. nr.	SD501
Diameter magneet	mm 7
Lengte ingetrokken-uitgetrokken	mm 160 / 550
Gewicht	kg 0,03
Afmetingen (l x b x h)	mm 15 x 14 x 178
Prijs	€ 8,20

TENGOOLS



3-delige inspectieset met telescopische werktuigen bestaande uit 1 inspectiespiegel, 1 vergrootglas en 1 magneet. Alle 3 met een cliphouder/zakkleem. TC-tray.

Order nr.	109460105 ^T
Orig. nr.	TTTT03
Diameter magneet	mm 12
Diameter vergrootglas/spiegel	mm 55
Gewicht	kg 0,22
Afmetingen (l x b x h)	mm 265 x 142 x 50
Prijs	€ 37,90

TENGOOLS



Telescopisch vergrootglas met kogelkop en pocket-clip. Handvat in rode anti-slip materie.

Order nr.	112270103 ^T
Orig. nr.	581TMG
Maximum lengte	mm 250 - 850
Diameter vergrootglas	mm 55
Gewicht	kg 0,08
Afmetingen (l x b x h)	mm 20 x 60 x 250
Prijs	€ 16,50

TENGOOLS



581TMI. Telescopische spiegel met kogelkop en pocket-clip. Handvat in rode anti-slip materie.

Order nr.	112280102 ^T
Orig. nr.	581TMI
Lengte	mm 250 - 850
Diameter spiegel	mm 57
Gewicht	kg 0,08
Afmetingen (l x b x h)	mm 30 x 57 x 250
Prijs	€ 18,90

TENGTOLS

581TMP. Telescopische pick-up magneet met pocket-clip. Handvat in rode anti-slip materie. Een prima lange magneet om magnetisch-metalen voorwerpen in moeilijk te bereiken plaatsen te bereiken.



Order nr.	112290101 ⓘ	
Orig. nr.	581TMP	
Diameter magneet	mm	12
Lengte ingetrokken-uitgetrokken	mm	180 - 850
Gewicht	kg	0,07
Afmetingen (l x b x h)	mm	20 x 19 x 180
Prijs	€	18,90

TENGTOLS



NEW

magneet verwijderbaar door verschuiven

Flexibel pick up werktuig met klauw en magneet.

Order nr.	186660106 ⓘ	
Orig. nr.	AT135M	
Lengte	mm	600
Prijs	€	22,50

TENGTOLS



Flexibele klauw-pick up. Bestaat uit een flexibele draad met niet-magnetische tang, regelbaar vanaf het handvat. Voor het vasthouden en het opnemen van kleine voorwerpen zoals schroeven en bouten in moeilijk te bereiken plaatsen.

Order nr.	117760108 ⓘ	
Orig. nr.	AT135	
Lengte	mm	600
Aantal klauwgrepen		4
Gewicht	kg	0,08
Afmetingen (l x b x h)	mm	23 x 45 x 600
Prijs	€	17,50

TENGTOLS



Magnetiseer en demagnetiseer gereedschap voor schroevendraaiertips.

Order nr.	60600103 ⓘ	
Orig. nr.	MR500	
Gewicht	kg	0,07
Afmetingen (l x b x h)	mm	60 x 30 x 20
Prijs	€	10,00

METALWORKS



Multifunctionele magnetische rail om ijzeren en stalen gereedschappen op te hangen. Kan magnetisch bevestigd worden aan een metalen achterwand zoals een werkbank of perfopaneel. Afmetingen 610x20x15mm. Capaciteit 2000 Gauss.

Order nr.	801106000 ⓘ	
Orig. nr.	MAG600	
Gewicht	kg	1,54
Prijs	€	12,50

METALWORKS



Magneetbaar lengte 600mm. Perfect om uw stalen gereedschappen aan te hangen. Kan aan elke magnetische achtergrond worden bevestigd, alsook via 2 bevestigingshaken. Capaciteit 10kg per 3cm. Afmetingen 610x20x15mm.

Order nr.	801105600 ⓘ	
Orig. nr.	MAG600A	
Lengte	mm	600
Gewicht	kg	1,60
Prijs	€	12,50

Meetinstrumenten

We leveren reeds bijna 100 jaar meetinstrumenten aan de industrie. Na verloop van tijd hebben we de behoeften en voorkeur van de klanten leren kennen. Onze producten zijn voortdurend ontwikkeld volgens de nieuwe productiemethoden en technologische vooruitgang.

Het merk Limit werd gecreëerd op basis van deze lange ervaring. Onze doelgroep heeft specifieke eisen voor precisie, kwaliteit, prijs en levertijd. We weten hoe op deze verzoeken te antwoorden. Met het merk Limit streven we ernaar om de Europese industrie een breed assortiment meetinstrumenten van hoge kwaliteit te bieden.

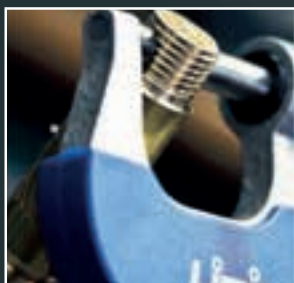

Grote cijfers
Goed leesbaar in alle
omstandigheden.

Display
Toont de correcte
testklem en de positie van
de draaiknop.
Gemakkelijk te gebruiken
en voorkomt fouten.

Rubberen holster
Beschermt het apparaat tegen
schokken en verlengt
zijn levensduur.

Handenvrij
Steunvoet aan de
achterzijde, zeer handig
als u met beide handen
moet werken.

Handleiding
In uw taal afgedrukt en in
een handig zakformaat





Afstandsmeters

Limit



L1045



L1060

Laser afstandsmeter. Snel, betrouwbaar en nauwkeurig meten. De rode laserpunt toont precies het te meten doel aan. Het slimme display toont de volgende stap in multi-step metingen, de gekozen functie en de laatste drie metingen. Berekenen van oppervlakte en ruimte. Pythagoras-functie voor het meten van hoogte van op een afstand. Optellen en aftrekken. Min, max en bijhouder resultaten. Geheugen voor 20 metingen. mm/inch omstelbaar. Verlichte display. Automatisch uit. Compleet geleverd met een zachte tas en handleiding. Geleverd zonder batterij. Conform norm EN61326-1 EMC, EN60825-1 Laser veiligheid.

Order nr.	178610051	178610101
Orig. nr.	L1045	L1060
Meetbereik	m 0,245	0,5-60
Nauwkeurigheid	mm ±2	±2
Batterijen	2x AA	2x AAA
Beschermingsklasse	IP 40	54
Werktemperatuur	°C 0 ... + 40	0 ... + 40
Opslagtemperatuur	°C -10 ... + 60	-10 ... + 60
Geheugens (aantal)	10	20
Gewicht	kg 0,10	0,10
Afmetingen (l x b x h)	mm 110 x 48 x 25	120 x 46 x 27
Prijs	€ 111,00	159,00

Limit



NEW

Stevig en schokbestendig ontwerp, geschikt voor gebruik buiten en vallen van 1 m.

Geschikt om langere afstanden betrouwbaar en snel te meten. De display toont de meting in verschillende stappen, de gekozen functie en de laatste 4 metingen. Berekent oppervlakte, totale muuroppervlakte en volume. Hoogte berekening door de stelling van Pythagoras, waar de horizontale meting automatisch wordt opgeslagen. Optellen en aftrekken. Continue meting. Functie minimum en maximum. Vooraf ingestelde lengtemeting met signaal. Geheugenfunctie. Verstelbaar referentiepunt vanaf de voorkant of de hoek. Omschakelbaar tussen meter, voet en duim. Display verlichting. Automatisch uitschakelen. Geleverd met zachte draagtas, batterijen en handleiding.

Vervaardigd volgens normen EN61326-1 EMC, EN60825-1.

Order nr.	178610200	
Orig. nr.	L1070	
Meetbereik	m	0.270
Nauwkeurigheid	mm	+/- 2
Geheugencapaciteit	20	
Werktemperatuur	°C	-10...+40
Opslagtemperatuur	°C	-20...+60
Stof- en waterdicht	IP	54
Batterij	2 pc type AAA	
Capaciteit batterij	Ah	5000
Gewicht	kg	0,18
Afmetingen (l x b x h)	mm	126 x 54 x 29
Prijs	€	181,00

Limit



Meetwiel. Meten van lange afstanden (wegenwerken). Met rem en staander. Plooibaar, met draagzak.

Order nr.	174280107	
Orig. nr.	MEASWH	
Meetbereik	m	10.000
Aflezing	dm	1
Nauwkeurigheid	mm/m	+/- 0,5
Gewicht inclusief zak	kg	2,5
Prijs	€	89,50

Kruislijnlasers



Kruislijnlaser. Compact, gemakkelijk mee te nemen. De verticale lijn bereikt 115 graden boven de laser. Zelfnivellerend of niet (schuine lijnen) verticaal en/of horizontaal lijnen. Vergrendeling voor transport. Kan gebruikt worden in openlucht of in sterk verlichte ruimtes met een aparte laser detector (detector 178620209 niet inbegrepen). 2 laserdiodes klasse 2M, 15 mw 635 nm. Geleverd met multifunctionele beugel, zachte tas, richtplaat en handleiding. Geleverd zonder batterijen (3xAA).

Order nr.	178620100 M	
Orig. nr.	L1001HV	
Aansluiting statief	inch	1/4"
Meetbereik	m	20-35 i.f.v. verlichting ruimte
Nauwkeurigheid	mm	±3mm/10m
Beschermingsklasse	IP	54
Werktemperatuur	°C	-10 ... + 50
Nivelleerbereik		±3°
Werkingsstijd	u	10
Gewicht	kg	0,40
Afmetingen (l x b x h)	mm	90 x 90 x 65
Prijs	€	137,00



Kruislijn- en punt laser. Compact formaat. Een horizontale lijn, een verticale lijn en 5 punten. De verticale lijn bereikt 115 graden boven de laser. Zelfnivellerend. Keuzeschakelaar voor afzonderlijke lijnen, cross lijnen en zelfnivellering of niet. Vergrendeling voor transport. Kan gebruikt worden in openlucht of in sterk verlichte ruimtes met een aparte laser detector (detector 178620209 niet inbegrepen). 2x15 mw 635 nm laser en 1x10 mw 635 nm voor de puntlaser, klasse 2M. Geleverd met muur/statief adapter, zachte tas, richtplaat en handleiding. Geleverd zonder batterij (3xAA).

Order nr.	178630109 M	
Orig. nr.	L1002HVP	
Aansluiting		1/4"
Beschermingsklasse	IP	54
Werktemperatuur	°C	-10 ... +50
Nauwkeurigheid lijn	mm	±3mm/10m
Nauwkeurigheid punten	mm	±4mm/10m
Nivelleerbereik		±4°
Werkingsstijd	u	7
Gewicht	kg	0,40
Afmetingen (l x b x h)	mm	113 x 115 x 70
Prijs	€	368,00



Laser met goed zichtbare lijnen. Een horizontale en vier verticale lijnen en een neerwaartse stip. De verticale lijnen kruisen elkaar bovenaan. Zelfnivellerend. Keuzeschakelaar voor aparte lijnen of meerdere lijnen. Vergrendeling voor transport. Geïntegreerde statief voor 360° rotatie. Fijninstelling schroeven voor draai beweging en hoogteverstelling van de voeten. Kan gebruikt worden in openlucht of in sterk verlichte ruimtes met een aparte laser detector (detector 178620209 niet inbegrepen). Kan enkel met statief 181120106 gebruikt worden. Geleverd met draagtas, richtplaat en handleiding. Geleverd zonder batterij (4xAA).

Order nr.	178640108 M	
Orig. nr.	L1004HV	
Nauwkeurigheid	mm	±2mm/10m
Beschermingsklasse	IP	54
Werktemperatuur	°C	-10 ... + 50
Nivelleerbereik		±3°
Werkingsstijd	u	7
Gewicht	kg	0,98
Afmetingen (l x b x h)	mm	110 x 130 x 190
Prijs	€	380,00



Roterende laser met automatische horizontale en verticale zelfnivellering. Scanmodus met verstelbare scanhoek. Zichtbare laserstraal. TILT functie, waarbij het instrument handmatig herstart moet worden als deze gekanteld werd. Laserdetector met een dubbel indicator venster, display verlichting, verstelbare toon en nauwkeurigheid. Afstandsbediening voor hellingregeling, draaisnelheid, scanhoek en scan positie. Het instrument kan gekalibreerd worden volgens de aanwijzingen in de handleiding. Geleverd in een harde plastic koffer met laserdetector, klemhouder, afstandsbediening, muur-beugel, richtplaat, oplaadbare batterij met lader en handleiding. Laser diode klasse 2M, 1mw 635nm

Order nr.	178650206 M	
Orig. nr.	L1200HV	
Bereik afstandsbediening	m	30
Beschermingsklasse	IP	54
Draaisnelheid	rpm	120-500
Werktemperatuur	°C	-10 ... +50
Nauwkeurigheid horizontaal	mm	±1,2mm/10m
Nivelleerbereik		±5°
Nauwkeurigheid verticaal	mm	±1,5mm/10m
Radius meetbereik	m	150
Werkingsstijd	u	20
Gewicht	kg	2,50
Afmetingen (l x b x h)	mm	152 x 174 x 188
Prijs	€	635,00

Limit



NEW

Roterende laser met automatische horizontale en verticale zelfnivellering. Verstelbare scanhoek. Zichtbare laserstraal. Mogelijk tot manuele helling. TILT functie, waarbij het instrument handmatig herstart moet worden als deze gekanteld werd. Laser detector met een dubbel indicator venster, display verlichting, verstelbare toon en verstelbare nauwkeurigheidsgraad. De afstandbediening stelt de helling, roteersnelheid, scanhoek en scanpositie in. Het instrument kan gekalibreerd worden volgens de aanwijzingen van de handleiding.

Geleverd in een harde plastic koffer, met laserdetector met klemhouder, afstandbediening, muurbeugel, richtplaat, oplaadbare batterij met lader en handleiding. Laserdiode klasse 2M, 1mw 635nm.

Order nr.	198640104	
Orig. nr.	L1210HV	
Bereik afstandbediening	m	30
Draaisnelheid	rpm	0-300-600
Werktemperatuur	°C	-10...+40
Stof- en waterdicht		54
Gebruikstemperatuur	°C	-10...+40
Inclinatie sensor meetbereik	°	5
Nauwkeurigheid horizontaal	mm	+/- 1.1 mm per 10 m
Nauwkeurigheid verticaal	mm	+/- 1.5 mm per 10 m
Radius meetbereik	m	200
Werkingsstijd	u	24
Gewicht	kg	2,50
Afmetingen (l x b x h)	mm	130 x 210 x 175
Prijs	€	715,00

Limit



Stevige roterende laser met automatische horizontale en verticale zelfnivellering. Vooral geschikt voor buitenshuis gebruik. Zichtbare laserstraal. Gemotoriseerde automatische nivellering met elektronische sensoren. Mogelijkheid tot manuele helling. TILT functie, waarbij het instrument handmatig herstart moet worden als deze gekanteld werd. Laserdetector met een dubbel indicator venster, display verlichting, verstelbare toon en hoge nauwkeurigheid.

Het instrument kan gekalibreerd worden volgens de aanwijzingen in de handleiding.

Geleverd in een harde plastic koffer, laserdetector met vastbarklem, oplaadbare batterij met lader, extra batterij houder voor losse batterijen en handleiding.

Laser diodes klasse 2m, 1 mw 635 nm

Order nr.	178660106	
Orig. nr.	L1300H	
Nauwkeurigheid	mm	±0,7mm/10m
Beschermingsklasse	IP	66
Draaisnelheid	rpm	600
Werktemperatuur	°C	-10 ... +50
Nivelleerbereik		±5°
Radius meetbereik	m	200
Werkingsstijd	u	18
Gewicht	kg	2,50
Afmetingen (l x b x h)	mm	166 x 166 x 222
Prijs	€	979,00

Limit



Laser detector. 35m. Te gebruiken wanneer rode laserpunt voldoende zichtbaar. Toepasbaar voor L1002HVP en L1004HV.

Order nr.	178620209	
Orig. nr.	L1001R	
Gewicht	kg	1,00
Afmetingen (l x b x h)	mm	20 x 10 x 10
Prijs	€	72,00



Telescopische aluminium meetstaaf. E lezing op voorkant en mm lezing op achterzijde. Elke sectie wordt automatisch vergrendeld na volledig uitbreiding. Lengte 5m.

Order nr.	178670105 M		
Orig. nr.	LEVRODS		
Gewicht	kg	1,00	
Afmetingen (l x b x h)	mm	10 x 10 x 1000	
Prijs	€	39,50	



Statief-aluminium. Geschikt voor diverse automatische waterpassen en laser instrumenten met schroefdraad bevestiging 5/8".

Order nr.	178680104 M		
Orig. nr.	TRIPOD		
Maximum hoogte	m	1,65	
Gewicht	kg	3,60	
Afmetingen (l x b x h)	mm	600 x 40 x 40	
Prijs	€	60,50	



Stevig aluminium statief. Wormwiel as voor nauwkeurige hoogteverstelling. Geschikt voor alle soorten automatische waterpassen en laser instrumenten met schroefdraad bevestiging 5/8".

Order nr.	178690103 M		
Orig. nr.	ROTSTAND		
Hoogteverstelling	mm	300	
Maximum hoogte	m	2,30	
Gewicht	kg	7,50	
Afmetingen (l x b x h)	mm	1000 x 30 x 40	
Prijs	€	150,00	



Aluminium statief voor Lasers. Eenvoudig te dragen, vouwen en ontvouwen. Wormwiel as voor nauwkeurige hoogteverstelling. 5/8" aansluiting. Ook geschikt voor Limit 1004 HV.

Order nr.	181120106 M		
Orig. nr.	ALUSTAND		
Lengte geplooid	mm	600	
Verstelbare hoogte	mm	300	
Gewicht	kg	1,80	
Prijs	€	37,00	

Bandendrukmeters



Digitale bandendrukmeter. Schakelt automatisch uit na 10 sec. Geleverd zonder batterijen.

Order nr.	132350109 M		
Orig. nr.	P300		
Batterij	3V CR2032		
Meetbereik	bar	0-7	
Gewicht	kg	0,15	
Prijs	€	14,90	

Binnenmeettasters



Universele binnenmeettaster. Meetunit met hardmetalen meettop. Automatische omkering van het meetpunt. Met zwaluwstaart-opname. Inclusief opspanschacht 6H6 - 8H6.

Order nr.	22590103 M		
Orig. nr.	BMTT		
Meetbereik	mm	0,8	
Schaalverdeling	mm	0,01	
Schaalverdeling		0-40-0	
Diameter klok	mm	30	
Lengte pin	mm	15	
Diameter stop	mm	6-8	
Prijs	€	65,90	



Universele binnenmeettaster. DIN2270. Stootvast. Meetunit met hardmetalen meettop. Automatische omkering van het meetpunt. Met zwaluwstaart-opname. Inclusief opspanschacht 6H6 - 8H6.

Order nr.	22590200 M	22590300 M	22590400 M	22590500 M
Orig. nr.	BMTH01	BMTV01	BMTH002	BMTV002
Meetbereik	mm 0,8	0,8	0,2	0,2
Schaalverdeling	mm 0,01	0,01	0,002	0,002
Type	horizontaal	verticaal	horizontaal	verticaal
Schaalverdeling	0-40-0	0-40-0	0-100-0	0-100-0
Diameter klok	mm 30	30	40	40
Lengte pin	mm 14,5	14,5	11,5	11,5
Prijs	€ 69,00	74,50	112,00	119,00



Digitale binnenmeettaster. Meet in 2 richtingen. mm en inch omstelbaar. Geleverd zonder batterijen (batterij 1x SR44).

Order nr.	167560101 M		
Orig. nr.	BMTDIG		
Meetbereik	mm	0,5	
Schaalverdeling	mm	0,001	
Nauwkeurigheid	mm	0,009	
Prijs	€	245,00	

Blokkalibers

OPTIMUM



- Voor het parallel opnemen van werkstukken in machineklemmen, opspanplaten, werktuigmachines, dit om een preciezere bewerking te bekomen.
- Set bestaande uit 18 blok kalibers. HRC 50-55.
- Speciaal gehard staal.
- Geslepen en handgepolijst per paar op 0.01 mm nauwkeurig.
- In een praktische kunststofkoffer.

- Inhoud 18 dlg
- 2 x 16 x 5 x 100 mm
- 2 x 18 x 6 x 100 mm
- 2 x 24 x 8 x 100 mm
- 2 x 30 x 10 x 100 mm
- 2 x 36 x 12 x 150 mm
- 2 x 48 x 14 x 150 mm
- 2 x 60 x 18 x 150 mm
- 2 x 62 x 22 x 150 mm
- 2 x 31 x 15 x 200 mm

Order nr.	713354000
Orig. nr.	VP.100
Stuks	18
Kalibers	van 5x16x100 tot 22x62x150
Prijs	€ 199,00

Limit



Eindmatenset (kaliber-set). Speciaal gehard staal. Geslepen en handgepolijst. Nauwkeurigheid DIN EN ISO 3650/0 of 1.

Order nr.	52720109	52720307	52720208	52720406
Orig. nr.	CA47DIN2	CA47DIN1	CA87DIN2	CA87DIN1
Aantal blokken	47	47	87	87
Capaciteit	mm 1,005	1,30 - 1,90	1,00 - 9,00	1,005
Aantal blokken (bereik) (1)	1 (0,005mm)	1 (0,005mm)	9 (0,001mm)	9 (0,001mm)
Capaciteit	mm 1,01 - 1,20	10,00 - 100,00	1,01 - 1,20	10,00 - 100,00
Aantal blokken (bereik) (2)	20 (0,01mm)	20 (0,01mm)	49 (0,01mm)	49 (0,01mm)
Aantal blokken (bereik) (3)	7 (0,10mm)	7 (0,10mm)	19 (0,50mm)	19 (0,50mm)
Aantal stuks	9 (1,00mm)	10 (10,00mm)	9 (1,00mm)	10 (10,00mm)
Tolerantie	DIN 861/2	DIN 861/1	DIN 861/2	DIN 861/1
Prijs	€ 560,00	825,00	785,00	1.229,00

OPTIMUM



Parallel onderlegplaten set 20dlg.

- Voor het parallel opnemen van werkstukken in machineklemmen, opspanplaten, werktuigmachines, dit om een preciezere bewerking te bekomen.
- Fijn geslepen op 0,01 mm nauwkeurig
- Inhoud 20 dlg:
- 2 x 13 x 3 x 150 mm
- 2 x 16 x 3 x 150 mm
- 2 x 19 x 3 x 150 mm
- 2 x 22 x 3 x 150 mm
- 2 x 28 x 3 x 150 mm
- 2 x 31 x 3 x 150 mm
- 2 x 35 x 3 x 150 mm
- 2 x 38 x 3 x 150 mm
- 2 x 41 x 3 x 150 mm
- In een praktische kunststofkoffer.

Order nr.	713354001
Orig. nr.	POP20
Stuks	20
Kalibers	van 13x3x150 tot 41x3x150
Prijs	€ 130,00

Boorkalibers

Limit



Kaliber voor boren. Wordt gebruikt bij slijpen van boren ter controle van de slijphoek. Gegradueerd tot 25 mm. Voor boren tot 50mm.

Order nr.	25650102
Orig. nr.	GRIGA25
Snijhoek	118°
Prijs	€ 4,90

Dieptemeters

Limit



Klassieke dieptemeter in roestvrijstaal. DIN 862. Gehard en geslepen meetpunt en meetbasis. Matverchroomde schaal in mm en nonius. Nonius 0,05mm. Geleverd in een opbergzakje.

Order nr.	Orig. nr.	Dieptemeting	Lengte basis	Prijs
		mm	mm	€
26430108	DEPA150	0-150	100	36,00
26430207	DEPA200	0-200	100	44,50
26430405	DEPA300	0-300	100	56,50
26430504	DEPA500	0-500	150	144,00

Limit



Dieptemeter in roestvrijstaal. DIN 862. Met omkeerbare schaal voor meten met haak of punt. Gehard en geslepen meetpunt en meetbasis. Matverchroomde schaal in mm en nonius. Nonius 0,05mm. Geleverd in een opbergzakje.

Order nr.	22550107 M	
Orig. nr.	DEPB300	
Afmetingen	mm	16x10
Dieptemeting	mm	0-300
Lengte basis	mm	150
Prijs	€	101,00

Limit



Dieptemeter in roestvrijstaal. DIN 862. Met omkeerbare schaal. Gehard en geslepen meetpunt en meetbasis. Matverchroomde schaal in mm en nonius. Nonius 0,05mm. Geleverd in een houten koffer.

Order nr.	26450106 M	26450205 M
Orig. nr.	DEPREV80	DEPREV200
Dieptemeting	mm	0-80
		0-200
Lengte basis	mm	50
		100
Prijs	€	35,00
		45,90

Limit



Digitale dieptemeter in roestvrijstaal. DIN 862. Gehard en geslepen. On/off switch. Aflezing 0,01mm - 0,0005". Mm/ inch omstelbaar. Geleverd zonder batterijen (batterij 1x SR44).

Order nr.	21460605 M	21469300 M
Orig. nr.	DM200	DEPDIG300
Dieptemeting	mm	0-200
		0-300
Lengte basis	mm	100
		100
Prijs	€	79,50
		128,00

Limit



Dieptemeter met vervangbare staven met stappen van 25 mm. Lezing 0,01 mm. Zeer leesbare matverchroomde houder en gegradueerde drum. Geslepen meetvlakken basis. Met slijpknop. Koffer met instelsleutel. DIN 863.

Order nr.	73250102 M	
Orig. nr.	DPMC100	
Dieptemeting	mm	0-100
Lengte basis	mm	63
Diameter vervangstaaf	mm	4,5
Prijs	€	96,50

Limit



Dieptestop-voet passend op de meeste schuifmaten

Order nr.	73120107 M	
Orig. nr.	DEPSTOP72	
Diepte gleuf	mm	4
Breedte gleuf	mm	16,5
Lengte stop	mm	75
Prijs	€	15,90

Limit



Digitale dieptemeter. Te gebruiken bij vb. het meten van autobanden. Geleverd zonder batterijen (batterij 1x SR44).

Order nr.	132360108 M	
Orig. nr.	TYRETHREAD	
Dieptemeting	mm	0-25
Afmetingen meettip	mm	5x4
Afmetingen stop	mm	55x6
Prijs	€	47,50

Limit



Dieptemeter. De beweging van de meetstaaf wordt via een tandwiel naar de klok overgemaakt. Dit verzekert een hoge nauwkeurigheid. Aflezing 0,01mm. Meetstaven afzonderlijk beschikbaar en verlengt het diepteinterval van 10mm tot max 120mm.

Order nr.	26510107 M	
Orig. nr.	DEPDGAU	
Dieptemeting	mm	10
Basislengte	mm	80
Diameter klok	mm	58
Prijs	€	305,00

Limit



Meetstaven voor dieptemeter 26510107.

Order nr.	Orig. nr.	Lengte mm	Prijs €
26510131 M	MTB10	10	10,50
26510164 M	MTB20	20	10,50
26510206 M	MTB30	30	10,50
26510305 M	MTB60	60	10,50
26510404 M	MTB90	90	10,50



Diktemeters



Diktemeter. Voor binnenmeting. Geharde ronde meetpunten. Draaibare schaal. Geleverd in houten koffer.

Order nr.	22720106 ^M	22720205 ^M
Orig. nr.	DMINT30	DMINT50
Meetbereik	mm 10-30	30-50
Schaalverdeling	mm 0,01	0,01
Een toer van de naald	mm 2	2
Diepte meetpunt	mm 100	150
Diameter meetpunt	mm 2,6x1,5	2,6x1,5
Prijs	€ 142,00	168,00



Diktemeter. Pocket model. Voor zachte en harde materialen.

Order nr.	119150100 ^M
Orig. nr.	DMPOCK
Meetbereik	mm 0-10
Schaalverdeling	mm 0,01
Diameter meetvlak	mm 8
Diepte	mm 12
Prijs	€ 72,00



Diktemeter. Pocket model - extra korte hals. Voor zachte en harde materialen.

Order nr.	119160109 ^M
Orig. nr.	DMSHO
Meetbereik	mm 0-10
Schaalverdeling	mm 0,01
Diameter meetvlak	mm 10
Diepte	mm 30
Prijs	€ 80,50



Diktemeter met 120mm diepe hals. Voor zachte en harde materialen.

Order nr.	119170108 ^M
Orig. nr.	DMDEE
Schaalverdeling	mm 0,01
Diameter meetvlak	mm 10
Diepte	mm 120
Meetbereik	mm 0-10
Prijs	€ 133,00



Diktemeter met digitale aflezing. On/off switch. Aflezing 0,01 mm - 0,0005". Mm/inch omstelbaar. Met automatische uitschakeling. Reset knop. Geleverd zonder batterijen (batterij 1x SR44).

Order nr.	22940100 ^M
Orig. nr.	DMDIG
Meetbereik	mm 0-15
Schaalverdeling	mm 0,01
Tolerantie	mm +/- 0,02
Diameter meetvlak	mm 8,9
Diepte	mm 13
Prijs	€ 133,00



Digitale diktemeter voor het meten van buitendikte/binnendiameter. Kan ook hoeken meten. Hold functie om gemeten waarden te bevroeren.

Order nr.	190200105 ^M
Orig. nr.	TRIKO60
Lengte arm	mm 400
Buiten	mm 0-570
Binnen	mm 35-600
Nauwkeurigheid	° + 1
Hoeken	° 0-180
Prijs	€ 62,00



Deze digitale diktemeter meet de coatingdikte van bvb.verf, kunststof, porselein, koper, zink, aluminium, chroomlaag op magnetische en niet-magnetische materialen. Automatische shut-off na 2 minuten. Geleverd zonder batterijen.

Order nr.	144830106 ^M
Orig. nr.	LIM5100
Bereik	µm 0-1000
Aflezing 0-100 µm	µm 0,1
Aflezing 100-1000 µm	µm 1
Nauwkeurigheid	+/- 2,5 µm (1-3%)
Batterij	4 pcs 1,5V (LR03 AAA)
Gewicht	kg 0,31
Afmetingen (l x b x h)	mm 161 x 69 x 32
Prijs	€ 475,00



Deze ultrasonische diktemeter meet de dikte van allerlei homogene materialen zoals metalen, glas en kunststoffen. Deze meter is aanbevolen wanneer slechts van één kant het meeststuk kan worden benaderd. Bvb. Buizen, tanks, glas, enz... Voorwaarde voor een correcte meting is een homogeen effen oppervlakte en 2 evenwijdige zijden. Automatische shut-off na 2 minuten. Geleverd zonder batterijen.

Order nr.	144840105 M	
Orig. nr.	L15500	
Bereik	mm	1,2200
Aflezings	mm	0,1
Probe diameter	mm	10
Nauwkeurigheid 1-10mm	mm	+/-0,4
Nauwkeurigheid 10-100mm	mm	+/-0,4 + 1%
Nauwkeurigheid 100-250mm	mm	+/-3%
Temperatuur	°C	0-50
Vochtigheid	RH%	0-80
Batterijen	4 x 1,5V LR03 AAA	
Gewicht	kg	0,17
Prijs	€	389,00

Draadsnijmeters



Draadsnijmeter. Voor het meten van de hoekinstelling. Gehard. Voor engelse en metrische draad.

Order nr.	25751009 M	25751108 M
Orig. nr.	THRE55W	THRE60WUN
Schaalverdeling	55°	60°
Hoogte	W	W+UN
Prijs	€ 4,70	4,70



Universele draadsnijmeter

Order nr.	25771007 M	
Orig. nr.	THREUNIV	
Draadhoekinstelling (V-draad)	55 o. 60	
Voor aantal stappen (Rechte hoek)	per inch	2 · 2,5 · 3 · 3,5 · 4 · 4,5 · 5 · 6 · 7 · 8
Voor stijgingen (30° hoek)	mm	2 · 3 · 4 · 5 · 6 · 7 · 8 · 9 · 10 · 12
Prijs	€	15,90

Flenshoekhaken



Flenshoekhaak. Uit speciaal staal. Verzinkt.

Order nr.	Orig. nr.	Afmetingen mm	Prijs €
25410200 M	FH300	300x300	26,00
25410309 M	FH400	400x400	31,50
25410408 M	FH500	500x500	40,50
25419600 M	FH600	600x600	47,50
25419800 M	FH800	800x800	81,50
25419010 M	FH1000	1000x1000	134,00
25419020 M	FH1500	1500x1500	230,00

Geluidsmeters



Digitale geluidsmeter - 2 verschillende metingen : A-meting : gebruikt voor omgevingsmetingen en beantwoordt aan het menselijk oor. C-meting : voor het analyseren van het geluid van machines, motoren, Een snelle meting wordt gebruikt voor kort lawaai, trage metingen worden gebruikt voor langdurige geluiden. Meetperiode van 10 sec. tot 24u. 30 Geheugengroepen. Kan op een PC aangesloten worden. Max. waarde functie, alarmfunctie wanneer een bepaalde waarde overschreven wordt. Automatisch en manuele on/off. Ingebouwde kalibratiesignaal 94dB. Standaard IEC 651 type 2, ANSI 1,4 type 2. Geleverd zonder batterijen.

Order nr.	151520103 M	
Orig. nr.	L17000	
Meetbereik	dB	30-130
Aflezings	dB	0,1
Nauwkeurigheid	dB	+/- 1
Meettijd snel	ms	125
Meettijd traag	sec	1
Tijd periodes	10 sec · 1 min · 5 min · 10 min · 15 min · 30 min · 1h · 8h · 24h	
Geheugengroepen	30	
Frequentie bereik	Hz	20-12500
Gewicht	kg	0,75
Afmetingen (l x b x h)	mm	236 x 63 x 26
Prijs	€	115,00



Accessoires voor Limit 7000.

Order nr.	151520202 M	151520301 M	151520400 M
Orig. nr.	LIM7000SOF	LIM7000CA	LIM7000
Omschrijving	Kabel + software voor pc (connectie RS-232)	Calibreertoestel 94 + 114 dB	AC adaptor 230V
Gewicht	kg	0,05	0,38
Prijs	€ 78,50	250,00	7,50

Gradenbogen

Limit



Gradenboog. Speciaal staal. Matverchromde schaal. Met stelschroef.

Order nr. 25490103 M

Orig. nr.	GBRO	
Lengte been	mm	150
Gradenboog schijfvormig	mm	rond
Diameter schijf gradenboog	mm	85
Prijs	€	14,90

Limit



Gradenboog. Speciaal staal. Schaalverdeling 0-180°. Matverchromde schaal. Met vaststelschroef.

Order nr.	Orig. nr.	Diameter gradenboog		Lengte been	Prijs
		mm	mm		
25480104 M	GB80	80	120	150	24,50
25480203 M	GB120	120	150	200	26,50
25480302 M	GB150	150	200	300	34,90
25480401 M	GB200	200	300	500	39,90
25489010 M	GB250	250	500	600	44,50
25489020 M	GB300	300	600		92,50

Limit



Gradenboog. Speciaal staal. Met glijdend been. Schaalverdeling 10-170°. Matverchromde schaal. Met stelschroef.

Order nr. 25500109 M 25500208 M 25500406 M

Orig. nr.	GBO150		GBO200	GBO300
Diameter gradenboog	mm	150	200	300
Lengte been	mm	300	400	600
Prijs	€	42,50	55,50	103,00

Limit



Precisiegradenboog. Roestvrij staal. Met roterende schaal voor snelaflezing en naald voor fijnaflezing. Verschuifbare lineaal en 360° draaibare hoekaanslag.

Order nr. 119190106 M

Orig. nr.	GBH300	
Lengte meetlat	mm	300
Lengte hoekmeter	mm	65
Bereik per toer van de naald	mm	10
Prijs	€	102,00

Limit



Precisiegradenboog. Roestvrij staal. Met roterende schaal voor snelaflezing en naald voor fijnaflezing met vergrootglas voor lezing. Verschuifbare lineaal en 360° draaibare hoekaanslag nonius $1/12^\circ = 5 \text{ min.}$

Order nr. 122580103 M

Orig. nr.	GBEC1/12	
Lengte meetlat	mm	150-300
Prijs	€	89,50

Limit



Digitale gradenboog. Roestvrij staal. Mogelijk lezingen: 0-360°, 0-180° of 0-90°. Kan gebruikt worden in alle posities. Vastzetten van de gemeten waarden. 2 meetlatten 150 en 300mm. Vastzethoek 90°. Geleverd zonder batterijen (batterij 1x CR2032).

Order nr. 151270105 M

Orig. nr.	GBDIG	
Schaalverdeling	°	0-360, 0-180 of 0-90
Resolutie	°	0,1
Nauwkeurigheid	°	+/- 0,2
Lengte meetlat	mm	150 - 300
Prijs	€	420,00

Limit



Digitale gradenboog met waterpas op bovenkant. Kan in alle posities gebruikt worden. Vastzetten van de gemeten waarden met vastzetgroef. Geleverd zonder batterijen (batterij 1x CR2032).

Order nr. 166580100 M

Orig. nr.	DG250	
Schaalverdeling	°	0-360
Resolutie	°	0,1
Nauwkeurigheid	°	+/- 0,25
Lengte	mm	250
Hoogte display	mm	13
Prijs	€	72,90

Limit



Mini digitale waterpas en gradenboog. De display duidt twee waarden aan: een absolute waarde en een relatieve waarde. Gekantelde display voor een duidelijke aflezing. Nulstelling in elke positie. Magneet op de basis voor vaststelling op zaagblad, stalen frame, enz. Schakelt automatisch uit na 3 minuten. 2 batterijen AAA 1,5V niet meegeleverd.

Order nr. 174250209 M

Orig. nr.	WPD10	
Bereik	°	0 - 180
Minimum aflezing	°	0,1
Nauwkeurigheid	°	+/- 0,3
Stof -en waterdicht		IP 54
Prijs	€	52,50



Digitale precisie waterpas. Aflezing 0-90°. Alternative hoek 0-100%. Magnetisch met V-groef. Kan in alle posities gebruikt worden. Vastzetten van de gemeten waarden. Display draait wanneer pas met 180° gedraaid wordt. Verlichte display. Met automatische uitschakeling na 3 minuten. Geleverd zonder batterijen.

Order nr.	174260109
Orig. nr.	DW150
Graden	4x90°
Lezingshoek	0-100%
Resolutie	mm 0,1°
Nauwkeurigheid	+/- 0,3°
Batterijen	1x3V CR2032
Afmetingen	mm 150x50x33
Prijs	€ 105,00

Graveermachines



Elektrisch graveerapparaat. Isolatieklasse II. Trilt teneinde stippen te maken. Met klem voor vastzetten van punten en besturingsregeling voor gewenste bewegingsafstand, om zowel diepte als breedte van de inslagen te wijzigen. Kan gebruikt worden op de meeste materialen zoals metaal, glas, porselein, plastic, hout, leder e.d. Voor het markeren van objecten tegen diefstal. Bij een continu gebruik dient het apparaat na 20 minuten stilgelegd te worden voor een periode van 30 minuten. 230 V. Geleverd met 4 graveerpunten voor metaal.

Order nr.	85140101
Orig. nr.	HANDYENGR
Trilfrequentie	slagen/min 6000
Verbruik	W 20
Gewicht	kg 0,62
Afmetingen (l x b x h)	mm 300 x 300 x 70
Prijs	€ 143,00



Accessoires voor graveerapparaat. 7400119: Hardmetalen punt met extra fijne top voor glas en metaal. 7400041: 2 hardmetalen punten (extra hard) met ruwe punt voor harde metalen. 90275: Een ring voor verbinding van hardmetalen en diamanten punten in het graveergereedschap. A8: Slijppunt en bevestigingsring.

Order nr.	Orig. nr.	Powerline nummer	Gewicht kg	Afmetingen (l x b x h) mm	Prijs €
65610404	TIP7400119	7400119	0,01	300 x 300 x 70	33,50
65610206	TIP74041	7400041	0,01	300 x 300 x 70	40,50
65611006	TIP90275	90275	5,60	300 x 300 x 70	4,00
65611105	TIPA8	A8	0,50	300 x 300 x 70	33,00

Hardheidsmeters



Deze digitale hardheidsmeter meet de hardheid van zachte materialen zoals rubber, neoprene, silicone, vinyl enz. Een veerbediende-pin wordt tegen het materiaal gedrukt en de Shore A waarde verschijnt op de display. Het te meten werkstuk moet vlak zijn en de voet van de tester loodrecht op het werkstuk. Minimum diameter van het werkstuk is 12mm met eveneens 12mm afstand van het uiteinde van het meetstuk. Calibrering kan uitgaan van een teststuk. Een gemiddelde hardheid kan worden bepaald na 2 à 9 metingen. Automatische shut-off na 1 minuut. Toestel conform volgende standaards : DIN 53505, ISO 868, ASTM D 2240. Geleverd zonder batterijen.

Order nr.	144850104
Orig. nr.	LIM40
Batterij	V 1,5 (4 pcs LR03 AAA)
Bereik	Shore A 0-100
Minimum dikte materiaal	mm 6
Nauwkeurigheid	% +/-1
Vochtigheidsgraad	% 0-80
Werktemperatuur	°C 0-50
Gewicht	kg 0,17
Afmetingen (l x b x h)	mm 150 x 50 x 30
Prijs	€ 374,00



Hoogtemeters

Limitr



Hoogtemeter in werkplaatsstaal. DIN 862. Met fijnafstelling en vastzetschroef. Gehard en geslepen. Matverchroomde schaal en nonius. Nonius 0,05mm. Geleverd in een houten opbergdoos.

Order nr.	22490056 ^M	22490106 ^M	22490205 ^M
Orig. nr.	HM300	HM500	HM1000
Afmetingen basis	mm 110x60	150x90	220x150
Hoogte kraspen	mm 300	500	1000
Prijs	€ 97,00	148,00	555,00

Limitr

Accessoires voor hoogtemeters HMKR.

Order nr.	22490304 ^M	22490403 ^M
Orig. nr.	HMKR300	HMKR500100
Accessoire	extra kraspunt voor 22490056	extra kraspunt voor 22490106 en 22490205
Prijs	€ 15,90	19,50

Limitr



Digitale hoogtemeter in roestvrij staal. DIN 862. Instelbare meetrichting. Gehard en geslepen. On/off switch. Aflezing 0,01 mm. 0,0005. Mm/inch omstelbaar. Connectie met PC mogelijk. Geleverd in een houten opbergdoos, zonder batterijen (batterij 1 x CR2032).

Order nr.	21461108 ^M	21461306 ^M
Orig. nr.	HMD300	HMD500
Meetbereik	mm 300	500
Nauwkeurigheid	mm +/- 0,03	+/- 0,03
Prijs	€ 295,00	442,00

Limitr

Accessoires voor digitale hoogtemeters HMDIG.

Order nr.	21461207 ^M	21461405 ^M
Orig. nr.	HMK300	HMK500
Accessoire	Extra kraspunt voor 21461108	Extra kraspunt voor 21461306
Prijs	€ 25,50	35,90

Inspectieapparatuur

Limitr



Inspectiespiegel. Verstelbare telescopische arm. Met extra magneet voor het terugvinden van onderdelen op moeilijk bereikbare plaatsen. De spiegel kan in verschillende posities geplaatst worden. Vernikkeld. Met pocket clip.

Order nr.	53070108 ^M
Orig. nr.	INSP69-45
Diameter spiegel	mm 35
Lengte	mm 200 - 685
Lengte met magneet	mm 150 - 625
Prijs	€ 27,00

TENGTTOOLS



581TMI. Telescopische spiegel met kogelkop en pocket-clip. Handvat in rode anti-slip materie.

Order nr.	112280102 ^T
Orig. nr.	581TMI
Lengte	mm 250 - 850
Diameter spiegel	mm 57
Gewicht	kg 0,08
Afmetingen (l x b x h)	mm 30 x 57 x 250
Prijs	€ 18,90

TENGTTOOLS



Telescopisch vergrootglas met kogelkop en pocket-clip. Handvat in rode anti-slip materie.

Order nr.	112270103 ^T
Orig. nr.	581TMG
Maximum lengte	mm 250 - 850
Diameter vergrootglas	mm 55
Gewicht	kg 0,08
Afmetingen (l x b x h)	mm 20 x 60 x 250
Prijs	€ 16,50

TENGTTOOLS



581TMP. Telescopische pick-up magneet met pocket-clip. Handvat in rode anti-slip materie. Een prima lange magneet om magnetisch-metalen voorwerpen in moeilijk te bereiken plaatsen te bereiken.

Order nr.	112290101 ^T
Orig. nr.	581TMP
Diameter magneet	mm 12
Lengte ingetrokken-uitgetrokken	mm 180 - 850
Gewicht	kg 0,07
Afmetingen (l x b x h)	mm 20 x 19 x 180
Prijs	€ 18,90

Limit



Inspectiecamera. Met Pc connectie. Met led verlichting. Waterproof camera kop en flexible arm (IP 67). Zelfdragende flexible arm. Geleverd met magneet, haak, Pc Kabel, software. Te gebruiken in combinatie met een PC.

Order nr.	167770106 M	
Orig. nr.	IC90	
Lengte camera arm en kop	m	0,9
Diameter camerakop	mm	14
Arm diameter	mm	9
Focus	mm	60 - ∞
Zichthoek	°	54
Pixels	640x480	
Lengte USB kabel	m	2
Prijs	€	84,00

Limit



Inspectie video camera met 2,4" LCD monitor. Voor inspectie en het oplossen van problemen in muren, elektrische kasten, motoren, enz. Gemakkelijke inspectie in donkere en onbereikbare ruimtes. Geïntegreerde LED verlichting in camerakop. Het beeld kan op de monitor getoond worden. De camera en flexibele arm zijn zelfdragend en waterdicht IP67.

Accessoires zoals spiegel, haak en magneet vergemakkelijken het opvangen van gevallen voorwerpen. Geleverd met spiegel, haak en magneet. Batterijen (4x1,5V AA) en SD-kaart niet inbegrepen.

Order nr.	190120105 M	
Orig. nr.	IC24	
Diameter camerakop	mm	9
Zichthoek	°	50
Pixels	640x480	
Werktemperatuur	°C	-10... +50
Monitor	2,4" LCD	
Lengte arm en camerakop	mm	900
Diameter arm	mm	9
Water- en stofbestendig	IP	67
Prijs	€	122,00

Limit



Inspectiecamera met afneembare draadloze monitor. Tot 10 meter vrije afstand vereenvoudigt de inspectie vooral in smalle en ontoegankelijke ruimten en wanneer u een inspectie wilt verrichten voor een lange periode. Voor de inspectie en het oplossen van problemen binnen muren, machines, elektrische kasten, riolering, enz. Het beeld kan met 180° gedraaid worden op de monitor. Waterdichte camerakop en slang. Accessoires : spiegel, haakje en magneet inbegrepen.

Order nr.	174270108 M	
Orig. nr.	DVS24	
Diameter camerakop	mm	17
Zichthoek	°	50
Pixels	640x480	
Lengte arm en kop	m	0,9
LED	inch	2,4
Batterij	4 x 1,5V AA	
Batterij monitor	Li batterij (herlaadbaar)	
Diameter cameraarm	mm	8
Werktemperatuur	°C	-10 - +50
Prijs	€	232,00

Limit



Accessoires voor inspectiecamera
174270108

Order nr.	Orig. nr.	Omschrijving	Prijs €
174270405 M	ICH58	camerakop 5,8mm voor inspectie camera, met slanglengte 0,9m	91,50
174270207 M	INSPT	Verlengstuk slang 2m, aan te sluiten op camerakop van 9mm en op de slang van 0,9m, voor een totale lengte van 2,9m.	87,00
174270306 M	INSPH9	camerakop - 9mm met slang lengte 0,9m	119,00

Limit



Inspectie camera met 3,5" LCD kleurenscherm en opname functie. Afneembare monitor met draadloze camera-eenheid aansluiting tot 10 m. De beelden kunnen opgeslagen worden op een SD-kaart, om later op de monitor of op een PC of TV-scherm bekeken te worden. De afneembare monitor vergemakkelijkt inspectie, vooral in gesloten en moeilijk bereikbare ruimtes, en voor een lange periode. Geschikt voor inspectie en het oplossen van problemen in muren, elektrische kasten, motoren, enz. Geïntegreerde LED-verlichting in de camerakop met instelbare helderheid. De camera en de flexibele arm zijn zelfdragend en water- en stofbestendig IP67.

De accessoires zoals spiegel, haak en magneet vergemakkelijken het opvangen van gevallen voorwerpen. Geleverd met 2G geheugenkaart, USB-kabel en TV-aansluitingskabel, kleurenmonitor, haak en magneet. Batterijen niet inbegrepen (4x1,5V AA).

Order nr.	190110106 M		
Orig. nr.		IC35	
Zichthoek	°	50	
Pixels		640x480	
Werktemperatuur	°C	-10... +50	
Monitor		3,5" LCD	
Lengte arm en camerakop	mm	900	
Diameter arm	mm	8	
Prijs	€	288,00	

Limit



Accessoires voor inspectiecamera
174270108

Order nr.	Orig. nr.	Omschrijving	Prijs €
174270405 M	ICH58	camerakop 5,8mm voor inspectie camera, met slanglengte 0,9m	91,50
174270207 M	INSPT	Verlengstuk slang 2m, aan te sluiten op camerakop van 9mm en op de slang van 0,9m, voor een totale lengte van 2,9m.	87,00
174270306 M	INSPH9	camerakop - 9mm met slang lengte 0,9m	119,00

Limit



Werkplaatsloep. Transparante acrylbuis aan de basis zorgt voor een goede verlichting.

Order nr.	53360103 M	53360202 M	167790104 M
Orig. nr.	LOP1960	LOP1966	LOP10
Vergroting	x 5	10	10
Diameter focus	mm 29	29	25
Prijs	€ 22,50	34,90	12,50

Limit



Werkplaatsloep. Met geïntegreerd licht. Transparante acrylbuis aan de basis. Zonder batterijen geleverd (batterij 2x LR14).

Order nr.	53370102 M		
Orig. nr.		LIGHTLUPE1966	
Focus	mm	29	
Vergroting	x	10	
Prijs	€	58,50	

Limit



Vergrootglas met schaalverdeling lengte, hoek, radius en licht. ring voor het instellen van de focus. Geleverd zonder batterij (batterij 1x4LR44).

Order nr.	167800200 M		
Orig. nr.		LOP10A	
Vergroting	x	10	
Diameter focus	mm	30	
Schaal	mm	25	
Schaalverdeling	mm	0,1	
Prijs	€	67,90	

Limit



Loep. Met schaalverdeling lengte. Ring voor het instellen van de focus. Transparante acrylbuis voor een goede verlichting.

Order nr.	17100108 M		
Orig. nr.		SCALELUPE	
Vergroting	x	10	
Diameter focus	mm	28	
Schaal	mm	20	
Schaalverdeling	mm	0,1	
Prijs	€	133,00	

Limtr



Loep. Met schaalverdeling. 5 veranderlijke schalen. Lengte, diepte, dikte en draad schalen. Nauwkeurigheid 0,1 mm (nauwkeurigheid dikte 0,01 mm). Ring voor focus. Transparante acrylbuis aan de basis zorgt voor een goede verlichting. Geleverd in een plastic koffer.

Order nr.	53380101 M		
Orig. nr.	SCALUPE2004		
Vergroting	x	10	
Diameter focus	mm	25	
Schaalverdeling	mm	20	
Prijs	€	175,00	

Limtr



Mini microscoop. Met schaalverdeling en led verlichting. Ring voor het instellen geleverd of zonder batterij v.d. focus. (batterij 3 xSR44). Roterende schaalverdeling 360°.

Order nr.	167810100 M		
Orig. nr.	MSC20		
Vergroting	x	20	
Diameter focus	mm	6	
Schaal	mm	6	
Schaalverdeling	mm	0,05	
Prijs	€	159,00	

TENGOOLS



587. Vergrootglas met handgreep of op magnetische voet. Geleverd zonder batterijen.

Order nr.	172850109	172850208
Orig. nr.	587H	587S
Type	hand	stand
Uitvergroting x	3	3
Glas diameter	mm 100	100
LED wattage	W 1.3	1.3
Batterijen	AAA/2	AAA/2
Lichtsterkte	lumen 72	72
Prijs	€ 59,90	76,90

Krasblokken

Limtr



Krasblok. Met ronde gietijzeren voet. Stalen punt. Zonder fijnafstelling.

Order nr.	52380102 M		
Orig. nr.	SG38		
Hoogte as	mm	300	
Prijs	€	31,50	

Limtr



Krasblok. Met prisma-vormige gietijzeren voet. Stalen punt. Met verstelbare stang.

Order nr.	52430105 M		
Orig. nr.	SG43		
Hoogte as	mm	300	
Prijs	€	54,50	

Kraspennen

Limtr



Kraspen. 2-zijdig model.

Order nr.	52530102 M	52530201 M	52539010 M
Orig. nr.	KPDST	KPDHSS	KPDSTBULK
Lengte	mm 240	240	250
Diameter	mm 4	4	4
Type	stalen top	hss top	stalen top
Verpakking	indiv. - pvc zakje	indiv. - pvc zakje	bulk
Prijs	€ 4,20	8,10	3,10

Limtr



Kraspen. Hardmetalen punt. K30 kwaliteit.

Order nr.	24750101 M		
Orig. nr.	KPK30		
Lengte	mm	130	
Verpakking	indiv. - pvc zakje		
Prijs	€	7,30	

Limtr



Kraspen. Hardmetalen punt. K20 kwaliteit.

Order nr.	24741001 M		
Orig. nr.	KPK20		
Lengte	mm	150	
Diameter	mm	6	
Verpakking	indiv. - pvc zakje		
Prijs	€	3,09	

Limtr



Kraspen met puntslag. Hardmetalen punt. Wanneer de centerpunt wordt ingedrukt, lost een veer en wordt een indruk geslagen.

Order nr.	102300100 M		
Orig. nr.	KPPU		
Lengte	mm	140	
Prijs	€	28,50	



Accessoires kraspenen KPPU

Order nr.	102300209 ^M
Orig. nr.	KPPUPT
Accessoire	Vervangpunt 40x3mm
Prijs	€ 8,50



Kraspen met puntslag. Met handvat. Hardmetalen omkeerbare punt met 2 hardmetalen kanten.

Order nr.	24850109 ^M
Orig. nr.	KPREV
Totale lengte	mm 100
Diameter	mm 7
Prijs	€ 21,50



Accessoire voor kraspenen KPREV

Order nr.	24850208 ^M
Orig. nr.	KPREVPT
Accessoire	Vervangpunt voor kraspen
Prijs	€ 13,50



Automatische kraspen met vergrendeling. Hardmetalen punt. Met clip.

Order nr.	24821001 ^M
Orig. nr.	KPK20150
Lengte	mm 150
Prijs	€ 7,50



Accessoire kraspenen KPK20150.

Order nr.	24820201 ^M
Orig. nr.	KPK20PT
Lengte	mm 20x2
Accessoire	Vervangpunt voor kraspen
Prijs	€ 4,30



SCR01. Kraspen. Hardmetalen punt. Rond, gekarteld handvat.

Order nr.	173480107 ^T
Orig. nr.	SCR01
Lengte	mm 135
Prijs	€ 12,50

Lamptesters



Testlamp. Gemaakt in messing. Met naaldpunt voor doorprikken van de isolatie. Met kabel en pocketclip.

Order nr.	26460105 ^T
Orig. nr.	9850
Lengte	mm 120
Lengte kabel	mm 520
Lengte naaldpunt	mm 10
Voor voltage	V 6-24
Gewicht	kg 0,04
Afmetingen (l x b x h)	mm 18 x 70 x 220
Prijs	€ 7,90

Laskalibers



Laskaliber. Met 12 bladen.

Order nr.	74031006 ^M
Orig. nr.	LKA314
Schaalverdeling	mm 3-12
Prijs	€ 22,50



Laskaliber voor het meten in hoeken, verpakt in plastic doos.

Order nr.	97541007 ^M
Orig. nr.	LKA60DEGR
Lasnaad	mm 0-10
Hoogte	mm 0-10
Hoeken	° 70-90-150
Lengte	mm 45
Prijs	€ 41,50



Laskaliber. 60°-70°-80°-90°. Nauwkeurigheid 1/10mm.

Order nr.	25690108 ^M
Orig. nr.	LKA90DEGR
Schaalverdeling	mm 20
Prijs	€ 27,50

Maatlatten



Maatlat. Gehard roestvrij veerstaal. Extra dun. Schaalverdeling in mm. Met montageopening.

Order nr.	Orig. nr.	Lengte mm	Prijs €
27020106	MLF100	100	6,00
27020205	MLF150	150	6,00
27020304	MLF200	200	6,20
27020403	MLF300	300	6,60
27020502	MLF500	500	12,50
27020601	MLF1000	1000	33,50



Maatlat. Gehard roestvrij veerstaal. Zeer leesbare matverchromde schaal. Schaalverdeling in mm en 1/2mm. Tot 500mm: dubbelzijdige schaal. Met montageopening. EG Din 1L - Din 2768 M.

Order nr.	Orig. nr.	Lengte mm	Prijs €
121900100	LFL100	100	4,30
121900150	LFL150	150	3,20
121900200	LFL200	200	3,80
121900250	LFL250	250	4,30
121900300	LFL300	300	4,30
121900500	LFL500	500	8,40
121901000	LFL1000	1000	28,50
121902000	LFL2000	2000	48,50



Maatlat. Gehard roestvrij veerstaal. Zeer leesbare matverchromde schaal. Schaalverdeling in mm en inch. Met montageopening.

Order nr.	Orig. nr.	Lengte mm	Prijs €
27030055	MLFB150	150	8,50
27030105	MLFB300	300	13,50
27030204	MLFB500	500	27,50
27030303	MLFB1000	1000	52,90



Maatlat. Gehard roestvrij veerstaal. Zeer leesbare matverchromde schaal. Schaalverdeling in mm aan de bovenkant en in 1/2mm aan de onderkant. Met montageopening.

Order nr.	Orig. nr.	Lengte mm	Nauwkeurigheid mm	Prijs €
84270107	MLFF150	150	0,12	7,50
84270206	MLFF300	300	0,13	12,50
84270305	MLFF600	600	0,16	29,50
84270404	MLFF1000	1000	0,20	61,50
84270503	MLFF2000	2000	0,30	385,00
84270602	MLFF300A	3000	0,40	785,00



Maatlat. Gehard roestvrij veerstaal. EG DIN II - DIN 7168 M. Matverchromde schaal. Schaalverdeling in 1/2 mm. Dubbelzijdige schaalverdeling. Met montageopening.

Order nr.	Orig. nr.	Lengte mm	Omschrijving	Prijs €
121920500	LFLD500	500	alu	12,50
121923000	MIBLAFD3000	3000	inox	179,00
121925000	LFLD5000	5000	inox	275,00



Maatlat. EG DIN II - DIN 7168 M. Matverchromde schaal. Schaalverdeling in mm 1/2mm en inch (1/32, 1/64, 1/16). Met montageopening. Tot 500mm: dubbelzijdige schaalverdeling.

Order nr.	121930300	121930500
Orig. nr.	LFL300	LFL500
Lengte mm	300	500
Prijs €	9,50	19,50



Precisie maatlat met afgeschuinde rand. Schaalverdeling in mm.

Order nr.	27050608
Orig. nr.	MLP1500
Lengte mm	1500
Prijs €	235,00



Flexibele omtrekmeter conform DIN 7168 m. Maat 16 x 0,2mm. Met nonius Voor het meten van omtrek en diameter. Schaal in mm. Aflezing in 0,1mm. Uitvoering in inox.

Order nr.	Orig. nr.	Voor omtrek-meting mm	Voor diameter-meting mm	Prijs €
121941519	OMTR1500	60-5980	20-1900	193,00
121952030	OMTR20	60-950	20-300	90,50
121953070	OMTR3100	60-2200	20-700	120,00
121957011	OMTR700	60-3780	20-1200	145,00
121951115	OMTR1100	60-4720	20-1500	173,00
121951519	OMTR1500S	60-5980	20-1900	202,00
121951923	OMTR1900	60-7540	20-2400	243,00
121952327	OMTR2300	60-8500	20-2700	260,00
121952731	OMTR2700	60-9760	20-3100	290,00
121953135	LIOM3100	60-11310	20-3600	319,00

TENGTOOLS



Professionele rolmeter. Stevige kunststof behuizing met platte onderkant voor binnenmeting. Met stevige terugveer en sluiting voor het vastzetten van de rolmeter. Gegradueerd op 1 zijde in mm. Gereguleerde versie Klasse II. Leverbaar in lengtes van 3, 5 of 8m.

Order nr.	131920100	131920209	131920308
Orig. nr.	MT03MM	MT05MM	MT08MM
Lengte	m 3	5	8
Breedte	mm 13	19	25
Prijs	€ 6,40	9,20	18,50

Limit



Aluminium duimstok. Gradueerd op beide kanten in mm schaal. Samenplooibaar op 10cm of 20cm. EG CLASS III.

Order nr.	105900205	105900306
Orig. nr.	DSA1M	DSA2M
Lengte	mm 1000	2000
Opdeling	mm 5x200	10x200
Prijs	€ 10,50	20,50

Limit



Houten duimstok. Geel gelakt. Gegradueerd op beide kanten in mm-schaal. Samenplooibaar op 20cm. EG CLASS III.

Order nr.	105900407
Orig. nr.	FOLDWOOD
Lengte	mm 2000
Opdeling	mm 10x200
Prijs	€ 4,25

Limit



Meetlat. Getrokken staal. DIN 874/2 (25070) of DIN874/1 (25071-2). Rechthoekig profiel. Fijn gepolierd en gekalibreerd. (Vanaf 2500mm met I-profiel en 2 handgrepen).

Order nr.	Orig. nr.	Lengte mm	Prijs €
25070103	ML12500	500	123,00
25070202	ML121000	1000	204,00
25070301	ML121500	1500	351,00
25070400	ML122000	2000	459,00
25070509	ML122500	2500	739,00
25070608	ML12300	3000	1.105,00
25070707	ML1240	4000	2.495,00
25071507	ML11500	500	165,00
25071606	ML111000	1000	308,00
25071705	ML111500	1500	505,00
25071804	ML112000	2000	1.200,00
25071903	ML112500	2500	1.465,00
25072000	ML11300	3000	2.165,00
25072109	ML1140	4000	3.499,00

Limit



Meetlat. Werkplaatskwaliteit. Gepolierd. Zonder maatverdeling. Rechthoekig profiel. DIN 874/00. Zwarte 30° meethoek. Geleverd in een houten koffer.

Order nr.	Orig. nr.	Lengte mm	Prijs €
52090107	MLA75	75	19,90
52090206	MLA100	100	22,90
52090305	MLA200	200	33,90
52090404	MLA300	300	63,50

Limit



Meetlat. Werkplaatskwaliteit. Gepolierd. Zonder maatverdeling.

Order nr.	Orig. nr.	Lengte mm	Prijs €
25069010	ML3004	300	12,50
25069020	ML400	400	16,90
25060104	ML500	500	19,50
25069030	ML600	600	24,90
25069040	ML800	800	29,50
25060302	ML1000	1000	36,50
25060500	ML1500	1500	66,50
25060609	ML2000	2000	82,50
25060807	ML300	3000	264,00

Limit



Meetlat. Werkplaatskwaliteit. Gepolierd. Profiel met afgeschuinde hoek. Zonder maatverdeling.

Order nr.	Orig. nr.	Lengte mm	Prijs €
25059000	MLS300	300	16,90
25059011	MLS400	400	19,50
25050204	MLS500	500	23,90
25059012	MLS600	600	29,50
25059013	MLS800	800	36,50
25050501	MLS1000	1000	42,50
25050600	MLS1500	1500	77,50
25050709	MLS2000	2000	126,00
25059015	MLS3005	3000	276,00

MLL



Meetlat. Werkplaatsstaal. Gepolierd. Met mm-maatverdeling. Profiel met afgeschuinde hoek.

Order nr.	Orig. nr.	Prijs €
27109010	PML500	32,50
27109011	PML800	54,50
27109012	PML1000	60,50
27109013	PML1500	100,00
27109014	PML2000	137,00
27109015	PML300	236,00



Zelfklevende meetlint. Wit gelakt staal. Schaalverdeling in mm boven- en onderaan. cm (zwart) en dm (rood) aanduiding. Ook voor verticale paneelzaagmachines.

Order nr.	Orig. nr.	Lengte mm	Omschrijving	Voor type	Prijs €
801200802	MLZ1000	1000	links naar rechts	PPRO, C4,	12,00
801200803	MLZ2000	2000	links naar rechts	C5, H5, H6, P5, P6	21,50
801200813	MLZ2000A	2000	rechts naar links		22,50
801200804	MLZ300		rechts naar links	H7, P7	29,50
801200805	MLZ5000	5000	links naar rechts		46,50
801200814	MLZ5000B	5000	rechts naar links		47,50

Mallen



Schroefdraadmal. Voor type draad. Voor binnen- en buitenmaten.

Order nr.	25801002	25801200	25801101
Orig. nr.	SDM28W	SDM24M	SDM55MUNC
Type draad	W	M/UNC	M
Hoek	° 55	60	60
Aantal bladen	28	55	24
Voor type draad	per inch 4-62	4-42	-
Voor stijgingen	mm -	0,25-6	0,25-6
Prijs	€ 8,60	11,50	7,20

Order nr.	25801309	25801408
Orig. nr.	SDM30UNCF	SDM6PIPE
Type draad	M	G-pipe (R)
Hoek	° 60	55
Aantal bladen	24	6
Voor type draad	per inch 4-42	8-28
Voor stijgingen	mm -	-
Prijs	€ 8,80	3,70



Radiusmallen. Ter controle van holle en bolle oppervlaktes.

Order nr.	25841008	25841107	25841206
Orig. nr.	RADGA7	RADGA15	RADGA25
Aantal bladen	17+17	16+16	15+15
Voor radius	mm 1,7	7,5-15	15,5-25
Intervallen	mm (1-3)=0,25 en (3-17)=0,5	0,5	(15,5-20)=0,5 en (20-25)=1
Prijs	€ 12,50	13,50	13,50



Openingsmal. Voor het meten en checken van openingen en kleine gaten.

Order nr.	26390203
Orig. nr.	DIK3
Diameter	mm 1,5 - 3
Aantal pinnen	16
Prijs	€ 11,00



Openingsmal. Voor het meten van kegelvormige gaten. Matverchromde schaalverdeling-innox lichaam.

Order nr.	14411003
Orig. nr.	DIK15S
Schaalverdeling	mm 1-15
Lezen	mm 0,1
Schaal	mm 120
Dikte	mm 1,2
Prijs	€ 25,50



Openingsmal. Gehard en geslepen staal. Kegelvormigheid 1:10. Direct afleesbaar 0,1 mm. Nonius afleesbaar 0,01 mm. Geleverd met een beschermhuls voor de meetnaald.

Order nr.	26410209
Orig. nr.	DIKCONE
Voor diameter	mm 0 - 5
Prijs	€ 164,00



Profielmal. Om een afdruk te maken van het gewenste profiel bij ronde of onregelmatige lijnen. Bij het leggen van tapijt en vloeren, het maken van kasten en banken, bochten, etc. Ronde pinnen in roestvrij staal.

Order nr.	97390108	97390207
Orig. nr.	PFM150	PFM300
Lengte	mm 150	300
Maximum profiel diepte	mm 48	105
Prijs	€ 26,50	103,00

Markeerkrijt

Limit



Markeerkrijt. Voor het markeren van staal of andere metalen. Kan ook gebruikt worden op buiten gestockeerd metaal of metaal dat heropgewarmd moet worden. Wordt niet verwijderd door vuur of water. Kleur: wit. Rechthoekig (130x13x5). 100 stuks.

Order nr.	166380105 M
Orig. nr.	LKR130
Prijs	€ 23,50

Limit



Industrieel krijt. Stofvrij. Magnesium. Voor markering op metaal e.d. Smelt niet bij verhitting. Rechthoekig (90x12x12). Kleur: wit. VE = Verpakkingseenheid.

Order nr.	24690109 M
Orig. nr.	CHALK50
VE	50
Prijs/VE	€ 36,50

Limit



Geperste houder met clip. Vernikkeld. Geschikt voor krijt 166380105. Lengte 145mm.

Order nr.	166480103 M
Orig. nr.	LKH130
Prijs	€ 4,15

Markeerstiften

Limit



Markeerstift. Artline 400-XF. Voor duurzame markering en belettering op moeilijke oppervlaktes zoals metaal, plastic, glas, rubber, e.d. . Kan buiten gebruikt worden en op moeilijke plaatsen . Extra kleuroverdekkend. Ronde punt 2mm. Sneldrogend . VE = verpakkingseenheid. Xyleen vrij.

Order nr.	Orig. nr.	Artline 400-XF	Temperatuurbestendig	VE	Prijs/VE
27100106 M	ART400BLCK	zwart	370	12	79,00
27100155 M	ART400RE	rood	290	12	79,00
27100171 M	ART400GR	groen	290	12	79,00
27100205 M	ART400WH	wit	260	12	79,00
27100254 M	ART400BL	blauw	290	12	79,00
27100304 M	ART400YE	geel	290	12	79,00

Limit



Markeerstift Artline 725. Voor markering op poreuse en harde oppervlaktes. Zelfs op glanzende oppervlaktes. Fijne punt - 0,4 mm. Waterproof en Sneldrogend. Extra luchtdichting in dop. Met clip. Xyleen-vrij. Verkleurt niet. VE = verpakkingseenheid.

Order nr.	Orig. nr.	Artline 725	VE	Prijs/VE
23630106 M	ART725BLCK	zwart	12	41,50
23630205 M	ART725RE	rood	12	41,50
23630304 M	ART725BL	blauw	12	41,50

Meetstandaards

Limit



Meetstandaard. Magnetische kracht kan aan-of uitgeschakeld worden. Basisplaat in V vorm. Opname 6-8mm .

Order nr.	151280104 M
Orig. nr.	MB40
Maximum instelbare hoogte	mm 230
Afmetingen basis	mm 30x35x36
Diameter montageopening	mm 6-8
Magnetische kracht	kg 40
Netto gewicht	kg 2
Prijs	€ 43,50

Limit



151290202



151290103

Voet voor meettaster. Met opname 6-8mm.

Order nr.	151290103	151290202
Orig. nr.	DHOUNIV	FJFLOHOUNIV
Diameter opening/niveau type	mm 8 en 6	8
Afmetingen houder arm	mm 6 x 12	diam. 8
Lengte	mm 100	65
Prijs	€ 16,90	16,90

Limit



Meetstandaard op magnetische basis. Met on/off switch op de basis. V-vormige geslepen basis.

Order nr.	60191004 M
Orig. nr.	LIMS
Maximum instelbare hoogte	mm 250
Afmetingen basis	mm 50x55x58
Diameter montageopening	mm 8
Magnetische kracht	kg 75
Netto gewicht	kg 1,5
Prijs	€ 29,50

Limit



Magnetische basis voor meetstandaard 60191004.

Order nr.	60190600 M
Orig. nr.	MBS100
Magnetische kracht	kg 100
Prijs	€ 35,00

Limit



Meetstandaard op magnetische basis. Extra-zware uitvoering. Fijjinstelling. Opname 8mm. Met on/off switch op de basis. V-vormige geslepen basis.

Order nr.	119080208
Orig. nr.	MAGMSKL
Maximum instelbare hoogte	mm 330
Afmetingen basis	mm 50x55x58
Diameter montageopening	mm 8
Magnetische kracht	kg 80
Netto gewicht	kg 1,9
Prijs	€ 64,00

Limit



Meetstandaard 119080208 met meetklok 119110104

Order nr.	119081008
Orig. nr.	MAGMSD
Maximum instelbare hoogte	mm 330
Afmetingen basis	mm 58x50x55
Diameter montageopening	mm 8
Magnetische kracht	kg 80
Netto gewicht	kg 1,9
Meetbereik	mm 10
Schaalverdeling	0-100 - 100-0
Bereik per toer van de naald	mm 1
Diameter klok	mm 58
Prijs	€ 95,50

Meetklokken

Limit



Mini meetklok. Non-shock proof. Draaibare schaal. DIN 878.

Order nr.	103900106
Orig. nr.	DMINI
Bereik per toer van de naald	mm 0,5
Diameter klok	mm 40
Diameter stop	mm 8
Meetbereik	mm 5
Schaalverdeling	mm 0-50 - 50-0/0,01
Lengte pin	mm 13,00
Aantal schroeven	3
Achterkant	174240101
Prijs	€ 46,50

Limit



Meetklok. Non-shock proof. Draaibare schaal. DIN 878.

Order nr.	119110104	119110203
Orig. nr.	DNSH10	DNSH25
Bereik per toer van de naald	mm 1	1
Diameter klok	mm 58	58
Diameter stop	mm 8	8
Meetbereik	mm 10	25
Schaalverdeling	mm 0-100 - 100-0/0,01	0-100 - 100-0/0,01
Lengte pin	mm 21	34
Aantal schroeven	3	4
Achterkant	174240101	174240200
Prijs	€ 36,50	74,50

Limit



Meetklok. Non-shock proof. Draaibare schaal. DIN 878.

Order nr.	119120103
Orig. nr.	DNSH001
Bereik per toer van de naald	mm 0,2
Diameter klok	mm 58
Diameter stop	mm 8
Meetbereik	mm 1
Schaalverdeling	mm 0-100 - 100-0/0,001
Lengte pin	mm 34,00
Achterkant	174240200
Prijs	€ 74,50

Limit



Meetklok. Shock proof.
Veranderlijke schaal. DIN 878.
Kan niet gebruikt worden met montagehaak.

Order nr.	43970201 M		
Orig. nr.	DSHPRS SHORT		
Bereik per toer van de naald	mm	1	
Diameter klok	mm	58	
Diameter stop	mm	8	
Meetbereik	mm	10	
Schaalverdeling	mm	0-100 - 100-0/0,01	
Lengte pin	mm	21,00	
Aantal schroeven		3	
Achterkant		174240101	
Prijs	€	56,00	

Limit



Meetklok. Shock proof.
Veranderlijke schaal. DIN 878.

Order nr.	119130102 M	119130201 M	
Orig. nr.	DSHPRL50	DSHPRL80	
Bereik per toer van de naald	mm	1	1
Diameter klok	mm	58	58
Diameter stop	mm	8	8
Meetbereik	mm	50	80
Schaalverdeling	mm	0-100 - 100-0/0,01	0-100 - 100-0/0,01
Lengte pin	mm	58	88
Aantal schroeven		4	4
Achterkant		174240200	174240200
Prijs	€	128,00	226,00

Limit



Meetklok voor groter meetbereik met afzonderlijk naald voor volledige mm. Koperen behuizing. Din 878. Nauwkeurigheid 0,1mm.

Order nr.	87620050 M		
Orig. nr.	DJOH30		
Bereik per toer van de naald	mm	10	
Diameter klok	mm	58	
Diameter stop	mm	8	
Meetbereik	mm	30	
Schaalverdeling	mm	0-100	
Prijs	€	125,00	

Limit



Digitale meetklok. Met tolerant functie. Absolute en toenemende meting. Reset knop. Mm/ inch omstelbaar. Din 878. Met automatische uitschakeling. Geleverd zonder batterijen (batterij 1x CR 2025).

Order nr.	151300100 M	151300209 M	151300308 M	
Orig. nr.	DDIG125	DDIG25	MD125	
Nauwkeurigheid	mm	0,02	0,02	0,013
Meetbereik	mm	0-12,5	0-25	0-12,5
Lengte pin	mm	24	34	24
Aantal schroeven		4	4	4
Achterkant		174240200	174240200	174240200
Aflezing	mm	0,01	0,01	0,001
Hoogte cijfers op display	mm	12	12	12
Diameter schijf	mm	57	57	57
Dikte meter	mm	26	26	26
Diameter pin	mm	8	8	8
Prijs	€	88,00	144,00	102,00

Limit



Hefarm en magnetisch voetje voor meetklokken. Montageopening diameter 8mm.

Order nr.	53180204 M	53180303 M	
Orig. nr.	DHE	DMAGVO	
Omschrijving	Hefarm	Magnetisch voetje	
Prijs	€	16,90	160,00

Limit



Achterkant voor Limit meetklok diameter 58mm.

Order nr.	174240101 M	174240200 M	
Orig. nr.	DVERS3	DVERS4	
Prijs	€	6,30	6,30

Limit

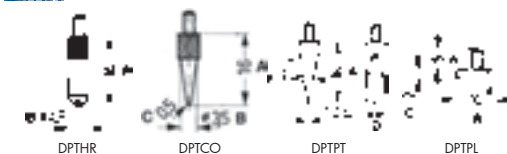

Meetpunten voor meetklokken

Order nr.	53181004 M	53181103 M	53181202 M	53181301 M	
Orig. nr.	DPTHR	DPTCO	DPTPT	DPTPL	
Tip	Half rond	Konisch	Plat	Plat	
Afmeting A	16	16	16	5	
Afmeting B	4,5	3,5	-	10	
Afmeting C	-	0,5	0,2	2	
Afmeting D	-	-	5	-	
Afmeting E	mm	-	20°	-	
Prijs	€	8,30	12,50	16,50	10,50

Kantentasters

TICHHORN



De 3-D taster onderscheidt zich door een zeer slank en attractief design. De precisie en veelzijdige inzetmogelijkheden maken het snel en eenvoudig bepalen van werkstuk nulpunten en lengtematen mogelijk. In zowel de X- Y- als Z-as een gelijke aflezing op de meetklok. Slankste tastereenheid ter wereld met een diameter van 26 mm. Europese kwaliteit.

Om beschadiging van de 3-D taster te voorkomen, heeft de tasterpunt een grote uitslag (X/Y) welke is begrensd met een mechanische eindaanslag. Het "breekpunt" boven in de tasterpunt voorkomt beschadiging van het gepatenteerde binnenwerk van de taster, indien deze toch over het mechanische eindaanslagpunt gevoerd wordt. Tastpunt met hardmetalen kogel. Tasterpunten (lang en kort) zijn eenvoudig zelf uit te wisselen. De 3-D taster wordt geleverd met de standaard tasterpunt \varnothing 3 mm, in een mooie kunststof koffer!

Order nr.	713539001 M	
Orig. nr.	3DCEN	
Nauwkeurigheid	mm	0,01
Diameter opnameschacht	mm	12
Diameter taster	mm	3
Prijs	€	369,00

METALWORKS



Mechanische kantentaster. Set uit 2 stuks. Uit hoog carbonstaal. Nauwkeurigheid 0,003 mm. Beide schacht diameter 10 mm en lengte 78 en 145 mm. Tpm 600 - 1.000.

Order nr.	713351170 M	
Orig. nr.	3351170	
Prijs	€	84,50

METALWORKS



Mechanische kantentaster. Ideaal om uw referentievlak / werkstuknulpunt eenvoudig vast te leggen. Werking: als de kantentaster het werkstuk aanraakt, lijkt de kantentaster uit een stuk vervaardigd, wanneer de taster en de schacht in lijn komen te staan, glijdt de taster uit zijn draaicenter. Nu bevindt zich de spindel center 5 mm weg van het te meten oppervlak. Tpm 450-600, nauwkeurigheid van nulpunt tot punt is binnen de 0.003 mm.

Order nr.	790003964 M	
Orig. nr.	KTM104	
Prijs	€	6,10

METALWORKS



Optische kantentaster met geluid. Ideale tool om uw werkstuknulpunt te bepalen en te gebruiken in meetopstellingen. Werking: als het rode licht oplicht, wordt ook de beeper geactiveerd. Zo blijft u ten allen tijde gewaarschuwd.

Voorbeeld: als u een diep gat dient op te meten en u kunt het licht niet meer zien, hoort u nog steeds het beep geluid. Rondlooppauwkeurigheid binnen de 0.005 mm.

LR 1 N batterijen. 1 set batterijen inbegrepen.

Order nr.	790003955 M	
Orig. nr.	KTL20	
Prijs	€	30,90

Limit



Hoogtemeter. Analog hoogte-meetapparaat met meetklok en magneetvoet voor snel en nauwkeurig bepalen van de Z-as positie tussen spindel en werkstuk. Referentiehoogte 50mm. Met kalibratie mechanisme.

Order nr.	153200100 M	
Orig. nr.	DDQ50	
Hoogte	mm	50
Schaalverdeling	mm	0,01
Prijs	€	309,00

Meetsets

TENGOOLS



5-delige meetset. Bestaande uit een digitale schuifmaat 150 mm, micrometer 0-25 mm, winkelhaak 150x100 mm, een stalen maatlat 150 mm en een kraspen 135 mm. Geleverd zonder batterijen (1x SR44). TC-tray.

Order nr.	167500206 T	
Orig. nr.	TTCM05D	
Aantal stuks	5	
Digitale schuifmaat	mm	0-150
Micrometers	mm	0-25
Winkelhaak	mm	150x100
Maatlat	mm	150
Kraspen	mm	135
Afmetingen (l x b x h)	mm	265 x 142 x 50
Prijs	€	115,00

Meetstokken

Limit



Telescopische meetstokken set 6-delige. Twee verende en geharde meetpunten. Vergrendeling aan bovenkant van de schacht. Lezing gebeurt door een micrometer of schuifmaat.

Order nr.	52910106 M		
Orig. nr.	MSTST		
Meetbereik	mm	8-150	
Prijs	€	34,50	

Limit



Afzonderlijke meetstokken uit set 52910106

Order nr.	Orig. nr.	Meetbereik mm	Prijs €
52910205 M	MST127	8-12,7	7,60
52910304 M	MST19	12,7-19	7,60
52910403 M	MST34	19-32	7,60
52910502 M	MST54	32-54	7,60
52910601 M	MST90	54-90	7,60
52910700 M	MST150	90-150	12,50

Micrometers

Limit



Micrometer in roestvrijstaal. DIN863. Nonius 0,01mm. Gehard en geslepen meetvlakken. Matverchroomde schaal in mm. Gesmede klem. Harde as 6,5mm. Met slijpknop en vergrendeling.

Order nr.	Orig. nr.	Meetbereik mm	Nauwkeurigheid mm	Prijs €
95380101 M	MICA25	0-25	+/- 0,004	34,50
95380200 M	MICA50	25-50	+/- 0,004	35,00
95380309 M	MICA75	50-75	+/- 0,005	36,50
95380408 M	MICA100	75-100	+/- 0,005	43,50

Limit



Micrometer in roestvrijstaal. DIN863/1. Geëmailleerde stalen beugel. Nonius 0,01mm. Gehard en geslepen meetvlakken. Matverchroomde schaal. Harde as 6,5mm. Met slijpknop en vergrendeling.

Order nr.	Orig. nr.	Meetbereik mm	Nauwkeurigheid mm	Prijs €
95420105 M	MICAL125	100-125	+/- 0,006	47,50
95420204 M	MICAL150	125-150	+/- 0,006	56,50
95420303 M	MICAL175	150-175	+/- 0,007	63,50
95420402 M	MICAL200	175-200	+/- 0,007	70,50

OPTIMUM



Buitenmicrometers. 6-delige set van 0 tot 150mm. Aflezing 0,01mm Matverchroomde schaalverdeling. Meetspil diam. 6,35mm. Meetvlakken van hardmetaal. Beugel met handbescherming. Meettrommel diam. 17mm. Met ratelinrichting. Spilspoed 0,5mm. Vanaf 25mm meetbereik met instellingsmaat. Inclusief houten kist. Nauwkeurigheid conform DIN 863/1.

Order nr.	713385100 M		
Orig. nr.	OPBM6		
Meetbereik	mm	0-150	
Micrometers	mm	0-25, 25-50, 50-75, 75-100, 100-125, 125-150	
Prijs	€	249,00	

Limit



Micrometer met teller in roestvrijstaal. DIN863. Lezing op 0,01mm. Nonius 0,001mm. Gehard en geslepen meetvlakken. Matverchroomde schaal. Gesmede klem. Harde as 6,5mm. Met slijpknop en vergrendeling.

Order nr.	87499101 M	87499102 M	87499103 M
Orig. nr.	MICXT50	MICXT75	MICXT100
Meetbereik	mm 25-50	50-75	75-100
Nauwkeurigheid	mm +/- 0,0004	+/- 0,0005	+/- 0,0005
Prijs	€ 66,90	74,50	87,00

Limit



Micrometer met digitale aflezing. DIN 863. Absolute en toenemende meting. Gehard en geslepen. On/off switch. Aflezing 0,001mm - 0,0005". Mm/inch omstelbaar. Met slijpknop en vergrendeling. Geleverd zonder batterijen (batterij 1xSR44).

Order nr.	132680109 M		
Orig. nr.	MICDIGA25		
Meetbereik	mm	0-25	
Nauwkeurigheid	mm	+/- 0,004	
Prijs	€	267,00	

Limit



Micrometer met digitale aflezing. IP54. DIN863. Lezing 0,001mm. Absolute en toenemende meting. Gehard en geslepen. On/off switch. Mm/inch omstelbaar. Met tolerantiefunctie; knipperend symbool wanneer de waarde onder de tolerantie ligt. Geleverd zonder batterijen (batterij 1x SR44).

Order nr.	Orig. nr.	Meetbereik mm	Nauwkeurigheid mm	Prijs €
96640107 M	MICAD25	0-25	+/- 0,004	154,00
96640206 M	MICAD50	25-50	+/- 0,004	174,00
96640305 M	MICAD75	50-75	+/- 0,005	204,00
96640404 M	MICAD100	75-100	+/- 0,005	227,00



Micrometer met digitale aflezing aan beide kanten van de micrometer. IP54. Aflezing mogelijk voor zowel links- als rechshandige. Lezing 0,001 mm. Absolute en toenemende meting. Gehard en geslepen. On/off switch. Mm/inch omstelbaar. Met tolerantiefunctie ; knipperend symbool wanneer de waarde onder de tolerantie ligt. Geleverd zonder batterijen (batterij 1x CR2032).



Order nr.	120600101	
Orig. nr.	MICDIGC	
Meetbereik	mm	0-30
Nauwkeurigheid	mm	+/- 0,004
Prijs	€	274,00



Micrometerset met 2 meetstukken. Hardmetalen meetvlakken. Lezing 0,001 mm. Diam. meetvlakken 8mm. Spoed 0,5 mm met ratelsysteem. Geëmailleerde stalen beugel en matverchroomde schaal. Digitale aflezing. DIN 863. Geleverd zonder batterijen (batterij 1x SR44).

Order nr.	96760103	
Orig. nr.	MICAD150	
Meetbereik	mm	0-150
Nauwkeurigheid	mm	+/- 0,006
Prijs	€	300,00



Micrometerset met 2 meetstukken. Hardmetalen meetvlakken. Lezing 0,01 mm. Diam. meetvlakken 8mm. Spoed 0,5 mm met ratelsysteem. Geëmailleerde stalen beugel en matverchroomde schaal. DIN 863.

Order nr.	95440103	95440200	95440202
Orig. nr.	MMS20150	MMS21020	MMS215030
Meetbereik	mm 0-150	100-200	150-300
Nauwkeurigheid	mm 0,006	-	0,006
Meetstukken	mm 0-25 - 25-50 - 50-75 - 75-100 - 100-125 - 125-150	100-125 - 150-175	150-175 - 175-200 - 200-225 - 225-250 - 250-300
Maatstukken	mm 25 - 50 - 75 - 100 - 125	100 - 125 - 150 - 175	150 - 175 - 200 - 225 - 275
Prijs	€ 241,00	234,00	302,00



Micrometerset met 2 meetstukken. Hardmetalen meetvlakken. Lezing 0,01 mm. Diam. meetvlakken 8mm. Spoed 0,5mm met ratelsysteem. Geëmailleerde stalen beugel en matverchroomde schaal. DIN 863.

Order nr.	Orig. nr.	Meetbereik	Nauwkeurigheid	Meetstukken	Prijs
		mm	mm	mm	€
95450102	MMS2L3040	300-400	0,011	325 en 375	292,00
95450201	MMS2L4050	400 - 500	0,013	425 en 475	326,00
95450300	MMS2L5060	500 - 600	0,015	525 - 575	390,00
95450409	MMS2L6070	600 - 700	0,016	625 en 675	461,00
95450508	MMS2L7080	700 - 800	0,018	725 en 775	430,00
95450607	MMS2L8090	800 - 900	0,020	825 - 875	499,00
95450706	MMS2L90100	900 - 1000	0,020	925 - 975	559,00
95451200	MMS2L10120	1000 - 1200	0,020	1050 en 1150	1.025,00
95451400	MMS2L120140	1200 - 1400	0,024	1250 - 1350	1.219,00
95451600	MMS2L140160	1400 - 1600	0,028	1450 en 1550	1.385,00
95451800	MMS2L160180	1600 - 1800	0,031	1650 en 1750	1.535,00
95452000	MMS2L180200	1800 - 2000	0,034	1850 - 1950	1.875,00



Micrometer met conische meetpunten. Buismicrometer. Lezing 0,01 mm. Gesmede beugel en matverchroomde schaal. Geharde as 6,5 mm. Diameter raakvlak 4,8 mm. Met slipknop en vergrendeling. DIN863.

Order nr.	95480109	
Orig. nr.	MICCON25	
Meetbereik	mm	0-25
Nauwkeurigheid	mm	+/- 0,006
Prijs	€	76,50



Micrometer. Lezing 0,01 mm. Gesmede beugel en matverchroomde schaal. Geharde as 6,5 mm met hardmetalen meetpunten. Met slipknop en vergrendeling. DIN 863.

Order nr.	95640108	
Orig. nr.	MICPT25	
Meetbereik	mm	0-25
Nauwkeurigheid	mm	+/- 0,004
Prijs	€	92,00

Limit



Micrometer met platte meetvlakken. Lezing 0,01 mm. Gesmede beugel en matverchroomde schaal. Geharde as 8,0 mm. Met slipknop en vergrendeling. DIN 863.

Order nr.	96090105 <small>M</small>
Orig. nr.	MICFL25
Meetbereik	mm 0-25
Nauwkeurigheid	mm +/- 0,004
Bladdikte	mm 0,75
Hoogte x breedte been	mm 6,5x6
Prijs	€ 180,00

Limit



Micrometer met afgeronde platte meetvlakken. Lezing 0,01 mm. Gesmede beugel en matverchroomde schaal. Geharde as 7,5 mm. Met slipknop en vergrendeling. DIN 863.

Order nr.	96130109 <small>M</small>
Orig. nr.	MICROUND25
Meetbereik	mm 0-25
Nauwkeurigheid	mm +/- 0,004
Hoogte x breedte been	mm 6x6
Dikte been	mm 3,5
Prijs	€ 180,00

Limit



Draadmicrometer. Lezing 0,002 mm. Gesmede beugel en matverchroomde schaal. Geharde as 6,5 mm. Fijngeslepen meetvlakken. Met slipknop en vergrendeling. DIN 863.

Order nr.	96140108 <small>M</small>
Orig. nr.	MICDR13
Meetbereik	mm 0-13
Nauwkeurigheid	mm +/- 0,004
Hoogte meting	mm 5
Prijs	€ 84,90

Limit



Speermicrometer. Voor gebruik in meettoestellen, controleapparaatuur of machines. Lezing 0,01 mm. Geharde as diam. 6 mm. Fijngeslepen hardmetalen meetvlakken. Matverchroomde houder en gegradueerde drum. Met slipknop en vergrendeling. DIN 863/1.

Order nr.	73240103 <small>M</small>
Orig. nr.	MICSP25
Meetbereik	mm 0-25
Diameter x lengte	mm 12x17
Prijs	€ 56,50

Limit



Binnenmicrometer in roestvrijstaal. Nonius 0,01 mm. Gehard en geslepen meetvlakken. Matverchroomde schaal. Met slipknop en vergrendeling. Lezing 0,01 mm. DIN 863.

Order nr.	Orig. nr.	Nauwkeurigheid	Meetbereik	Prijs
			mm	€
96150107	MMI30	+/- 0,007	5-30	89,50
96150206	MMI50	+/- 0,007	25-50	95,00
96150305	MMI75	+/- 0,008	50-75	123,00
96150404	MMI100	+/- 0,008	75-100	147,00

Limit



Micrometerhouder. Draaibaar.

Order nr.	102380102 <small>M</small>
Orig. nr.	MICHDROT
Breedte x lengte basis	mm 80x120
Klembereik	mm 7-16
Prijs	€ 35,00

Limit



Micrometerhouder. Zeer zware en stabiele uitvoering. Uit speciaal gietijzer. Voor micrometers van 20 tot 300 mm.

Order nr.	123040100 <small>M</small>
Orig. nr.	MICHD
Maximum klembereik	mm 20
Prijs	€ 29,50

Limit



Controleschroefmaten. Voor controleren en kalibreren van micrometers en ander meetgereedschap. Gehard hoogwaardig staal.

Order nr.	Orig. nr.	Nauwkeurigheid	Lengte	Prijs
			mm	€
26243006	MTS25	+/- 0,5 um	25	5,90
26243105	MTS50	+/- 1 um	50	6,50
26243204	MTS75	+/- 1 um	75	7,50
26243303	MTS100	+/- 1,5 um	100	8,60
26243402	MTS125	+/- 1,5 um	125	10,50
26243501	MTS150	+/- 2 um	150	10,50
26243600	MTS175	+/- 2 um	175	12,50
26243709	MTS200	+/- 2,5 um	200	13,50



3-punts interne micrometers. Heeft drie meetvlakken wat resulteert in een betere centrering en nauwkeurigheid dan tweepuntsmeting. Lezing 0,005 mm. Hardmetalen meetvlakken met verlangstuk van 150mm. Matverchroomde schaal en gegradueerde drum. Met slipknop. Koffer met instelring.

Order nr.	127810109	127810208	127810307	127810406
Orig. nr.	MM3P1216	MM3P1620	MM3P2025	MM3P2530
Meetbereik mm	12-16	16-20	20-25	25-30
Nauwkeurigheid mm	+/- 0,004	+/- 0,004	+/- 0,004	+/- 0,004
Dieptemeting mm	80	80	90	90
Prijs €	179,00	179,00	390,00	390,00

Order nr.	127810505	127810604	127810703
Orig. nr.	MM3P3040	MM3P4050	MM3P5063
Meetbereik mm	30-40	40-50	50-63
Nauwkeurigheid mm	+/- 0,004	+/- 0,005	+/- 0,005
Dieptemeting mm	97	97	114
Prijs €	279,00	319,00	505,00



Complete set met driepuntsmicrometer en instelring. Heeft drie meetvlakken wat resulteert in een betere centrering en nauwkeurigheid dan tweepuntsmeting. Lezing 0,005 mm. Hardmetalen meetvlakken. Matverchroomde schaal en gegradueerde drum. Met slipknop. Koffer met instelring.

Order nr.	127820108	127820207
Orig. nr.	MM3PST2050	MM3PST50100
Meetbereik mm	20-50	50-100
Aantal instelringen	2	2
Aantal micrometers	4	4
Dieptemeting mm	240-247	264
Verlengstuk mm	150	150
Prijs €	929,00	1.219,00



Set met micrometerkop en verlengstukken. Matverchroomde houder en gegradueerde drum. Geharde bolvormige hardmetalen meetvlakken. Geleverd met montagebeugel. Lezing 0,01 mm. DIN 863.

Order nr.	96230107	96230206	96230305
Orig. nr.	MMSS250	MMSS600	MMSS1400
Meetbereik mm	50-200	50-600	150-1400
Aantal	5	7	9
Prijs €	147,00	218,00	1.269,00



Cilindrische binnenmeetaster. Voor het meten van diameter van gaten en breedte van groeven. Set met vervangtips met stappen van 1 mm. Meetpunten uit hardmetaal. Compleet met meetklok. DIN 878.

Order nr.	Orig. nr.	Meetbereik mm	Dieptemeting mm	Aantal meetpunten	Prijs €
61931002	MTS1018	10-18	100	9	143,00
61931101	MTS1835	18-35	125	9	112,00
61931200	MTS3550	35-50	150	4	112,00
61931309	MTS50160	50-160	150	12	112,00
61931408	MTS160250	160-250	400	12	149,00



Cilindrische binnenmeetaster. Met meetklok. Aflezing 0,01 mm. Werkplaatsuitvoering.

Order nr.	110100010	110100018	110100035	110100050
Orig. nr.	BMTC1610	BMTC11018	BMTC11835	BMTC13550
Meetbereik mm	6-10	10-18	18-35	35-50
Aantal meetstukken	4	9	5	3
Meetstukken mm	6,65 - 7,5 - 8,6 - 10	10-18 mm (+0,1 mm)	21 - 24,5 - 28 - 31 - 35	40 - 45 - 50
Diameter klok mm	50	40	58	58
Meetdiepte mm	40	100	125	150
Diameter meetpin mm	25	34	40	-
Prijs €	193,00	152,00	154,00	154,00

Order nr.	110100100	110100160	110100250
Orig. nr.	BMTC150100	BMTC150160	BMTC1100250
Meetbereik mm	50-100	50-160	100-250
Aantal meetstukken	5+1	6+1	4+1
Meetstukken mm	60 - 70 - 80 - 90 - 100 - verlengstuk 50 mm	60 - 70 - 80 - 90 - 100 - 110 + 1 verlengstuk 50 mm	120 - 140 - 160 - 180 + 1 verlengstuk 80 mm
Diameter klok mm	58	58	58
Meetdiepte mm	150	150	220
Diameter meetpin mm	52	52	72
Prijs €	154,00	154,00	180,00



Multimeters

TOOLS

Limit

NEW



LI200



LI210



LI300 in opbergtas

Digitale multimeter met roterende functiekноп voor manuele instelling. Voor het meten van DC/AC voltage, DC stroom, weerstand, frequentie, capaciteit en temperatuur (afhankelijk van het type). Eveneens diode test, continuïteitstest met zoemer, opslaan van gegevens en waarschuwing bij platte batterij. Compleet geleverd met testsnoeren, temperatuursonde en handleiding, zonder batterijen. Met holster en steunklep. Limit 200 in zakformaat. Geleverd in een handige kleine opbergpochette. Zeer dun (ong. 12mm). Kan gemakkelijk worden opgeborgen in de werkkleding. Weergave van AC/DC spanning, weerstand, doorgang (met buzzer), diode, capaciteit en frequentie. Voorzien van datahold, laag-batterij waarschuwing en auto-off na 15 minuten. Geleverd met testsnoeren, batterij en handleiding. Limit 610 met RMS functie voor metingen van niet-lineaire signalen. Connecteerbaar met pc. Geleverd met pc kabel en software. LIMIT300 in opbergtas.

Order nr.	144880101 M	198650103 M	128600103 M
Orig. nr.	LI200	LI210	LI300
AC Stroomsterkte	ACA	-	-
AC Stroomsterkte: resolutie/nauwkeurigheid	mA	-	-
AC Voltage: resolutie/nauwkeurigheid	mV	1 mV +/-1,2% +3	0,1mV/ +/-1,2% +10
AC Voltage	ACV	4-40-300 V	4-40-400-600 V
Batterij	V	1 x 3 V (CR2032)	1 x 3 (CR2032)
Capaciteit	F	4-40-400 nF-4-40-200 µF	4-40-400 nF-4-40-200µF
Capaciteit: resolutie/nauwkeurigheid	pF	0,001 nF +/-4% +3	0.001 nF/ +/- 4% + 3 pF
DC Stroomsterkte	DCA	-	2000 µA-20-200 mA-10A
DC Stroomsterkte: resolutie/nauwkeurigheid	µA	-	0,1 µV/ +/-1% +2
DC Voltage	DCV	400 mV-4-40-300 V	4-40-600
DC Voltage: resolutie/nauwkeurigheid	mV	0.1 mV +/-0,8% +1	0.1 mV -4-40-300 V DCV
Dwell tachymeter: resolutie/nauwkeurigheid	-	-	200-2000 mV-20-200-500 V
Frequentie	Hz	10 Hz-100 KHz	0,1mV/ +/-1,2% +2
Frequentie: resolutie/nauwkeurigheid	Hz	0,01 Hz +/-0.5% +3	-
Maximum display	-	3999	3999
Motor tachymeter: resolutie/nauwkeurigheid	-	-	1999
Temperatuur	°C	-	-40 +1000
Temperatuur: resolutie/nauwkeurigheid	°C	-	1°C +/-1% +3
Veiligheidsisolatie	-	CATI1300V IEC61010	CATI1300V IEC61010
Weerstand	Ohm	400 Ohm-4-40-40KOhm-4-40 M Ohm	400 Ohm-4-40-40KOhm-4-40 M Ohm
Weerstand: resolutie/nauwkeurigheid	Ohm	0,1 +/-1% +2	0.1 +/-1% + 20
Duty Cycle	-	0.1 - 99.9%	0.1 - 99.9%
Frequentie: resolutie/nauwkeurigheid	-	-	+/- 0.5% + 3 digits
Batterij	-	-	1pc type CR2032
Gewicht	kg	0,60	0,19
Afmetingen (l x b x h)	mm	108 x 58 x 12	110 x 58 x 11
Prijs	€	25,50	30,00
			35,90



LI400



LI500



LI500A



LI610

Order nr.		190180109 M	128590106 M	128580107 M	153220108 M
Orig. nr.		LI400	LI500	LI500A	LI610
AC Stroomsterkte	ACA	2:200mA-20A	2:200mA-10A	-	600-6000 μ A-60-600 mA-6-10A
AC Stroomsterkte: resolutie/nauwkeurigheid	mA	1 μ A +/-1% +3	1 μ A +/-1% +3	-	0,1 μ A +/-1,2% +5
AC Voltage: resolutie/nauwkeurigheid	mV	1mV +/-0,8% +3	1mV +/-0,8% +3	1mV +/-0,8% +5	0,01mV +/-1% +5
AC Voltage	ACV	2:20-200-750V	2:20-200-1000V	2:20-200-750V	6-60-600-750V
Batterij	V	1x9V (6F22)	1x9V (6F22)	1 x 9 V (6F22)	1 x 9V (6F22)
Capaciteit	F	2:200 nF-20 μ F	2:200 nF-100 μ F	-	40-400 nF-4-40-400-4000 μ F
Capaciteit: resolutie/nauwkeurigheid	pF	0,01nF +/-4% +3	1pF +/-4% +3	-	0,01 nF +/-3% +5
DC Stroomsterkte	DCA	2:200mA-20A	2:200mA-10A	200 mA-10A	600-6000 μ A-60-600mA-6-10A
DC Stroomsterkte: resolutie/nauwkeurigheid	μ A	0,01 μ A +/-0,8% +1	0,01 μ A +/-0,8% +1	0,1 μ A +/-0,8% +5	0,1 μ A +/-1% +3
DC Voltage	DCV	400 mV-4-40-300 V	200 mV-2:20-200-1000 V	200 mV-2:20-200-1000 V	60-600 mV-6-60-600-1000V
DC Voltage: resolutie/nauwkeurigheid	mV	100 μ V +/-0,5% +1	0,1 mV +/-0,5% +1	0,1mV +/-0,5% +5	0,1mV +/-1,0% +3
Dwell tachymeter: resolutie/nauwkeurigheid	-	-	-	0,1° +/-3% +5	-
Frequentie	Hz	2:20KHz	2:20KHz	-	10Hz-10MHz
Frequentie: resolutie/nauwkeurigheid	Hz	1 Hz +/-1,5% +5	1 Hz +/-1,5% +5	-	0,001 Hz +/-0,1% +4
Maximum display	-	1999	1999	1999	6000
Motor tachymeter: resolutie/nauwkeurigheid	-	-	-	10rpm +/-3% +5	-
Temperatuur	°C	-40 +1000	-40 +1000	-	-
Temperatuur: resolutie/nauwkeurigheid	°C	1°C +/-4% +4	1°C +/-1% +3	1°C +/-1% +3	-
Veiligheidsisolatie	-	CATII600V/CATII1000V IEC 61010	CATII1000V/CATII600V IEC 61010	CATII1000V/CATII600V IEC 61010	CATIII1000V/CATIV600V, IEC 61010
Weerstand	Ohm	200 Ohm-2:20 K Ohm-2:20 M Ohm	200 Ohm-2:20-200 K Ohm-2:20 M Ohm	200 Ohm-2:20-200 K Ohm-2:20 M Ohm	600 Ohm-6-60-600 K Ohm-6-60 M Ohm
Weerstand: resolutie/nauwkeurigheid	Ohm	0,1 Ohm / +/-0,8% +1	0,1 Ohm / +/-0,8% +1	0,1 Ohm +/-0,8% +1	0,10 Ohm +/- 1,2% +2
Duty Cycle	-	-	-	-	-
Frequentie: resolutie/nauwkeurigheid	-	-	-	-	-
Batterij	-	-	-	-	-
Gewicht	kg	0,54	0,38	0,38	0,30
Afmetingen (l x b x h)	mm	172 x 83 x 38	179 x 88 x 39	179 x 88 x 39	177 x 85 x 40
Prijs	€	61,00	86,90	71,90	126,00



Accessoires voor multimeters.

Order nr.	Orig. nr.	Omschrijving	Prijs €
128600202	TCAB100	extra testsnoeren	7,30
128600301	LIM300SENS	kabel voeler type K -50 - +260°C, lengte kabel 900mm	8,50
128590205	LIM500AAN-SL	extra universele aansluiting voor verschillende doeleinden	9,10



Opberggas Limit. Voor Limit 500, 610.

Order nr.	198660102
Orig. nr.	L500SB
Prijs	16,90



LI20 LI21 LI23

Digitale multi- en ampèremeter met klem. Weergave van stroom AC (Limit 20) en AC/DC (Limit 21 en 23), AC/DC spanning, weerstand, doorgang (met zoemer), diode, capaciteit en frequentie. Het model Limit 23 heeft een zeer hoge meetnauwkeurigheid dankzij de RMS-meting (voor AC stroom). Voorzien van datahold, laag-batterij waarschuwing. Geleverd met testsnoeren, draagtas en handleiding. Geleverd zonder batterijen.

Order nr.	128560109	144870102	144860103
Orig. nr.	LI20	LI21	LI23
AC Voltage: resolutie/nauwkeurigheid	mV 1mV / +/- 1,2%+5	1mV / +/-1% + 5	1mV / +/- 1,2% + 5
AC Voltage	ACV 220-200-600V	4-40-400-600V	6,6-66-600V
Batterij	V 2 x 1,5 V (LR06)	9V (6F22)	9V (6F22)
DC Stroomsterkte	DCA -	40-400A	66-1000A
DC Stroomsterkte: resolutie/nauwkeurigheid	µA -	0,01A / +/-2% + 3	0,01A / +/- 1,5% + 8
DC Voltage	DCV 200 mV-220-600V	400mV-4-40-400-600V	6,6-66-600V
DC Voltage: resolutie/nauwkeurigheid	mV 100mV / +/- 0,8% + 1	0,1mV / +/- 0,8% + 1	0,1mV / +/- 0,8% + 1
Frequentie	Hz -	10Hz-1MHz	660Hz-6,6-66-660Hz
Maximum display	1999	3999	6666
Veiligheidsisolatie	CATII600V/CATIII300V IEC61010-	CATII600V/CATIII300V IEC61010	CATII600V/CATIII300V IEC61010
Weerstand	Ohm 200 Ohm-220-200 K Ohm 220 M Ohm	400 Ohm-4-40-400K Ohm 4-40M Ohm	46,6-66-600K Ohm-6,6-66M Ohm
Duty Cycle	-	0,1% - 99,9%	0,1% - 99,9%
AC Stroomsterkte	mA 220-200-400A	40-400A	66-1000A
AC Stroomsterkte: resolutie/nauwkeurigheid	Ohm 0,1 mA / +/- 4% + 5	0,01A / +/- 2,5% + 5	0,01A / +/-2% + 8
Weerstand: resolutie/nauwkeurigheid	F 0,1 Ohm / +/-1% + 2	0,1 Ohm / +/-1% + 2	0,1 Ohm / +/-1,2% + 2
Frequentie: resolutie/nauwkeurigheid	-	0,001Hz / +/-0,1% + 3	0,1Hz / +/- 0,1% + 3
Gewicht	kg 0,26	0,20	0,53
Afmetingen (l x b x h)	mm 208 x 75 x 30	210 x 76 x 30	285 x 105 x 45
Prijs	€ 53,50	84,90	179,00

Passers

Limtr



Stokpasser. Roestvrijstaal. Met vastzetschroef. Matverchroomde schaal en nonius. Geharde punt. Graduatie in mm. Nonius 1/10mm van lengte 39mm.

Order nr.	97170104 <small>M</small>	
Orig. nr.	SCRG200	
Meetlengte	mm	200
Diameter schrijfpunt	mm	2
Lengte kraspen	mm	32
Prijs	€	42,50

Limtr

Accessoire voor stokpassers SCRG200.

Order nr.	97170203 <small>M</small>	
Orig. nr.	SCRG200PT	
Accessoire	Extra schrijfpunt	
Prijs	€	4,30

Limtr



Stokpasser. Speciaal staal. Met fijnafstelling en vastzetschroef. Matverchroomde schaal en nonius 0,1mm. Gehard punt diam. 5mm. Graduatie in mm.

Order nr.	24130205 <small>M</small>	
Orig. nr.	STP3001	
Lengte staaf	mm	300
Prijs	€	207,00

Limtr

Accessoire stokpassers STP3001.

Order nr.	24130304 <small>M</small>	
Orig. nr.	STPPT1	
Accessoire	Extra markeerpunt diameter 5x56mm	
Prijs	€	22,50

Limtr



Gecombineerde passer en schuifmaat. Speciaal staal. Gehard en geslepen. Matverchroomde schaal en nonius 0,1mm.

Order nr.	24360208 <small>M</small>	
Orig. nr.	COMGA	
Lengte	mm	200
Lengte punten	mm	45
Prijs	€	117,00

Limtr



Stokpasser. Rechthoekige staaf uit speciaal staal. Graduatie in mm. Nonius 0,05 mm.

Order nr.	Orig. nr.	Lengte mm	Maximum diameter mm	Prijs €
24200107 <small>M</small>	STP50005	500	1000	380,00
24200206 <small>M</small>	STP100050	1000	2000	505,00
24200305 <small>M</small>	STP150005	1500	3000	615,00

Limtr



Passer voor potlood. Speciaal staal. Potlood niet inbegrepen.

Order nr.	24280109 <small>M</small>	24280208 <small>M</small>
Orig. nr.	STPEN175	STPEN300
Maximum capaciteit	mm 190	350
Lengte	mm 175	300
Prijs	€ 18,50	28,50

Limtr



Steekpasser. DIN 6486. Gesmeed staal. Geklonken. Met geharde punten en vierkante benen.

Order nr.	Orig. nr.	Lengte benen mm	Prijs €
24290207 <small>M</small>	STP150	150	8,90
24290405 <small>M</small>	STP200	200	9,80
24299010 <small>M</small>	STP250	250	11,50
24290702 <small>M</small>	STP300	300	15,50
24290801 <small>M</small>	STP400	400	36,50
24299020 <small>M</small>	STP500	500	40,50
24299030 <small>M</small>	STP600	600	74,50

Limtr



Steekpasser met vastzetschroef. DIN 6486. Gesmeed staal. Geklonken. Met geharde punten en vierkante benen.

Order nr.	24291007 <small>M</small>	
Orig. nr.	STPSCHR500	
Lengte benen	mm	500
Prijs	€	46,50

Limit



Krompasser. DIN 6484. Gesmeed staal. Geklonken. Met vlakke gepolijste benen.

Order nr.	Orig. nr.	Lengte benen mm	Maximum capaciteit mm	Prijs €
24399010	KRP150	150	-	7,50
24390502	KRP200	200	300	7,50
24399020	KRP250	250	-	11,50
24390700	KRP300	300	348	11,50
24391005	KRP500	500	850	32,90
24399030	KRP600	600	-	44,50
24391104	KRP800	800	1250	56,50
24399040	KRP1000	1000	-	105,00

Limit



Voetjespaser. DIN 6482. Gesmeed staal. Geklonken. Met vlakke gepolijste benen.

Order nr.	Orig. nr.	Lengte benen mm	Prijs €
24409010	VP150	150	7,50
24400509	VP200	200	7,50
24409020	VP250	250	10,50
24400707	VP300	300	11,50
24409030	VP600	600	44,50
24409040	VP800	800	74,50
24409050	VP1000	1000	105,00

Limit



Steekpaser met veer. DIN 6487. Met veer en snelspanschroef. Gesmeed staal. Geklonken. Met geharde punten en vierkante benen.

Order nr.	Orig. nr.	Lengte benen mm	Prijs €
24440208	24440208	100	8,90
24449010	STP125V	125	8,50
24440406	STP150V	150	11,50
24449020	STP175V	175	12,50
24440505	STP200V	200	13,50
24449030	STP250V	250	14,90
24441206	STP300V	300	14,90
24449040	STP400V	400	22,50
24449050	STP500V	500	26,50
24449060	STP600V	600	29,50

Limit



Voetjespaser met veer. DIN 6487. Gesmeed staal. Met veer en snelspanschroef. Geklonken. Met vlakke gepolijste benen.

Order nr.	Orig. nr.	Lengte benen mm	Prijs €
24459010	VP125V	125	8,50
24450405	VP150V	150	11,50
24450504	VP200V	200	13,50
24459020	VP250V	250	13,50
24450702	VP300V	300	20,50
24459030	VP400V	400	20,50
24459040	VP500V	500	23,90
24459050	VP600V	600	29,50

Limit



Precisie-afschrijfflineaal. Vlakke uitvoering. Werkplaatsstaal. Matverchromde mm-schaalverdeling. Gehard snijvlak.

Order nr.	Orig. nr.	Verstelbare lengte mm	Breedte mm	Prijs €
23790108	ASL200	200	40	24,50
23799010	ASL250	250	40	31,90
23790207	ASL300	300	40	30,90

Limit



Krompasser met veer. DIN 6487. Gesmeed staal. Met veer en snelspanschroef. Geklonken. Met vlakke gepolijste benen.

Order nr.	Orig. nr.	Lengte benen mm	Prijs €
24430407	KRP150V	150	11,50
24430506	KRP20V	200	13,50
24430704	KRP30V	300	20,50

Limit



Krompasser met veer. DIN 6487. Gesmeed staal. Met veer en snelspanschroef. Geklonken. Met vlakke gepolijste benen.

Order nr.	Orig. nr.	Lengte benen mm	Prijs €
24439005	KRP125VL	125	8,50
24439010	KRP250VL	250	12,50
24439020	KRP40VL	400	22,50
24439030	KRP50VL	500	23,90
24439040	KRP60VL	600	30,00

Limit



Steekpaser met vastzetschroef DIN 6486. Gesmeed staal. Geklonken met vastzetschroef. Met geharde punten en vierkante benen.

Order nr.	Orig. nr.	Lengte benen mm	Prijs €
122010150	STP150SCH	150	10,50
122010200	STP200SCH	200	12,50
122010250	STP250SCH	250	17,00
122010300	STP300SCH	300	21,50



Schuifmaten

Limit



Klassieke schuifmaat in messing. Lengte 100mm. MM en inch graduatie. Nonius 0,1mm. Buitenkant van de bekken kan worden gebruikt voor binnenmeting.

Order nr.	26540203 M		
Orig. nr.	CALMES100		
Meellengte	mm	100	
Lengte bek	mm	19	
Prijs	€	10,50	

Limit



Klassieke schuifmaat in roestvrij staal. DIN 862. Lengte 100mm. Gehard en geslepen. Met vastzetschroef. Met topspitsen en dieptemeter. Matverchroomde schaal en nonius. MM graduatie. Nonius 0,05mm. Geleverd in een praktisch opbergzakje.

Order nr.	60060100 M		
Orig. nr.	CALA100		
Meellengte	mm	100	
Lengte bek	mm	27	
Prijs	€	49,90	

Limit



Klassieke schuifmaat in roestvrij staal. DIN 862. Monobloc uitvoering. Gehard en geslepen. Met momentverstelling. Met topspitsen en dieptemeter. Matverchroomde schaal en nonius. MM en inch graduatie. Nonius 0,05mm.

Order nr.	26700302 M		
Orig. nr.	CALMON150		
Meellengte	mm	150	
Lengte bek	mm	40	
Prijs	€	21,90	

Limit



Klassieke schuifmaat in werkplaatsstaal. DIN 862. Gehard en geslepen. Met momentverstelling. Met topspitsen en dieptemeter. Matverchroomde schaal en nonius. MM en inch graduatie. Nonius 0,05mm. Geleverd in een praktisch opbergzakje.

Order nr.	119090108 M		69509010 M	
Orig. nr.	CALB150		CALB200	
Meellengte	mm	0-150	0-200	
Lengte bek	mm	40	40	
Prijs	€	14,90	43,50	

Limit



Schuifmaat met meetklok in roestvrijstaal. DIN 862. Gehard en geslepen. Met topspitsen en dieptemeter mm graduatie. Matverchroomde schaal en nonius. Geleverd in een kunststof opbergdoos.

Order nr.	52700309 M	52709200 M	52709300 M	
Orig. nr.	CALD150	CALD20	CALD300	
Meellengte	mm	150	200	300
Lengte bek	mm	40	50	60
Aflezings	mm	0,02	0,01	0,01
Prijs	€	58,50	76,90	121,00

Limit



Klassieke schuifmaat in roestvrij staal. DIN 862. Met momentverstelling en vastzetschroef. Gehard en geslepen. Met topspitsen en dieptemeter. Matverchroomde schaal en nonius. MM en inch graduatie. Nonius 0,05mm. Voor linkshandigen. Geleverd in opbergzakje.

Order nr.	102369150 M		102360104 M	
Orig. nr.	CALL150MO		CALL150VZ	
Meellengte	mm	150	150	
Lengte bek	mm	40	40	
Type	met momentverstelling		met vastzetschroef	
Prijs	€	39,50	41,50	

Limit



Klassieke schuifmaat in roestvrij staal. DIN 862. Met momentverstelling en vastzetschroef. Gehard en geslepen. Met topspitsen en dieptemeter. Matverchroomde schaal en nonius. MM en inch graduatie. Nonius 0,05mm.

Order nr.	152380101 M		
Orig. nr.	CALD300A		
Meellengte	mm	300	
Lengte onderste bek	mm	125	
Lengte bovenste bek	mm	56	
Prijs	€	197,00	

Limit



Schuifmaat in roestvrij staal voor het meten van remtrommels. DIN 862. Met vastzetschroef. Gehard en geslepen. Matverchromde schaal en nonius. Dubbele mm schaalverdeling voor binnen- en buitenmeting. Aflezing 0,1 en 0,05mm.

Order nr.	109090050 M	109090100 M	109090209 M
Orig. nr.	CALDR340	CALDR50	CALDR60
Meellengte	mm 40-340	50-500	50-600
Lengte bek	mm 105	150	200
Prijs	€ 193,00	311,00	423,00

Limit



Schuifmaat voor remschijven in roestvrij staal. DIN 862. Met fijninstelling en vastzetschroef. Gehard en geslepen. Matverchromde schaal en nonius. Aflezing 0,1mm.

Order nr.	109100107 M
Orig. nr.	CALDI60
Meellengte	mm 0-60
Lengte bek	mm 85
Prijs	€ 73,50

Limit



Digitale schuifmaat voor remschijven. Roestvrij gehard staal. "Hold" functie om de waarde te onthouden wanneer de schuifmaat wordt verwijderd na het meten. Nulpunt op elk ogenblik mogelijk. Mm en inch graduatie. (Batterij type V13GSV37 8SR 44).

Order nr.	139490106 M
Orig. nr.	SPD75RT
Meellengte	mm 75
Lengte bek	mm 92
Hoogte cijfers	mm 11
Aflezing	mm 0,01
Prijs	€ 104,00

Limit



Drie- en vijfpuntsschuifmaat. Voor het meten van 3- en 5-zijdig gereedschap. In roestvrij staal. Met vastzetschroef. Gehard en geslepen. Matverchromde schaal en nonius. MM en inch graduatie. Nonius 0,05mm.

Order nr.	23940109 M	23949900 M
Orig. nr.	CAL3PT	CAL5PT
Meetbereik diameter	mm 4-45	2-40
Type	3 puntsschuifmaat	5 puntsschuifmaat
Prijs	€ 98,00	89,50

Limit



Schuifmaat in roestvrij staal. Voor binnenmaatname met dubbele meetpunten. DIN 862. Met fijninstelling en vastzetschroef. Gehard en geslepen. Matverchromde schaal en nonius. Aflezing 0,1mm.

Order nr.	128170107 M
Orig. nr.	CALID150
Meellengte	mm 9-150
Lengte onderste bek	mm 74
Lengte bovenste bek	mm 35
Prijs	€ 125,00

Limit



Klassieke schuifmaat in roestvrij staal. DIN 862. Met momentverstelling en vastzetschroef. Gehard en geslepen. Met topspitsen en dieptemeter. Matverchromde schaal en nonius. MM en inch graduatie. Nonius 0,05mm.

Order nr.	122590102 M
Orig. nr.	CAL300
Meellengte	mm 300
Lengte bek	mm 60
Prijs	€ 50,90



Klassieke schuifmaat in roestvrij staal. Met fijnafstelling en vastzetschroef. Met gepunte bekken voor binnenmeting. Met bovenspitsen. Gehard en geslepen. Matverchroomde schaal en nonius. Nonius 0,05mm + 1/128". Geleverd in een houten opberghoos.

Order nr.	Orig. nr.	Meet- lengte	Lengte bek	Nauw- keurig- heid	D	E	B	F	Prijs
		mm	mm	mm	mm	mm	mm	mm	€
68762006	M CALI2060	200	60	0,05	20	5	40	12	80,50
68762508	M CALI25080	250	80	0,05	20	5	40	12	110,00
68763009	M CALI3090	300	90	0,05	20	5	40	12	123,00
68763010	M CALI30100	300	100	0,05	20	5	40	12	160,00
68763015	M CALI30150	300	150	0,05	20	5	40	12	266,00
68764010	M CALI40100	400	100	0,06	24	10	56	18	221,00
68764012	M CALI40125	400	125	0,06	24	10	56	18	261,00
68764015	M CALI40150	400	150	0,06	24	10	67	18	262,00
68764020	M CALI4020	400	200	0,06	24	10		18	329,00
68765015	M CALI50150	500	150	0,06	31	10	67	24	315,00
68765020	M CALI5020	500	200	0,07	31	10	67	24	370,00
68765025	M CALI50250	500	250	0,07	31	10	67	24	415,00
68766015	M CALI60150	600	150	0,07	31	10	67	24	361,00
68766020	M CALI6020	600	200	0,07	31	10	67	24	415,00
68766030	M CALI6030	600	300	0,12	31	10	67	24	595,00
68768015	M CALI80150	800	150	0,07	31	10	67	24	585,00
68768020	M CALI8020	800	200	0,07	31	10	67	24	639,00
68768030	M CALI8030	800	300	0,16	31	10	67	24	855,00
68768040	M CALI8040	800	400	0,16	31	10	67	24	1.029,00
68761015	M CALI10150	1000	150	0,10	31	10	67	24	639,00
68761020	M CALI1020	1000	200	0,10	31	10	67	24	775,00
68761030	M CALI1030	1000	300	0,14	31	10	67	24	1.045,00
68761220	M CALI12020	1200	200	0,14	42	10	80	24	989,00
68761230	M CALI12030	1200	300	0,14	42	10	80	24	1.510,00
68761520	M CALI15020	1500	200	0,20	42	10	80	24	1.405,00
68761530	M CALI15030	1500	300	0,20	42	10	80	24	1.720,00
68762020	M CALI2020	2000	200	0,30	42	10	80	24	1.825,00
68763020	M CALI3020	3000	200	0,30	50	10	80	24	3.599,00



Klassieke schuifmaat in roestvrijstaal. Met fijnafstelling en vastzetschroef. Met gepunte bekken voor binnenmeting. Zonder bovenspitsen. Gehard en geslepen. Matverchroomde schaal en nonius. Nonius 0,05mm + 1/128". Geleverd in een houten opberghoos.

Order nr.	Orig. nr.	Meet- lengte	Lengte bek	Nauw- keurig- heid	D	E	F	Prijs
		mm	mm	mm	mm	mm	mm	€
23052006	M CAL2060	200	60	0,05	20	5	12	62,90
23052508	M CAL25080	250	80	0,05	20	5	12	87,00
23050057	M CAL3090	300	90	0,05	20	5	12	95,00
23053010	M CAL30100	300	100	0,05	20	5	12	102,00
23053015	M CAL30150	300	150	0,05	20	5	12	212,00
23054010	M CAL40100	400	100	0,06	24	10	18	174,00
23054012	M CAL40125	400	125	0,06	24	10	18	213,00
23054015	M CAL40150	400	150	0,07	24	10	18	232,00
68764020	M CALI4020	400	200	0,06	24	10	18	329,00
23050206	M CAL50150	500	150	0,07	31	10	24	221,00
23055020	M CAL5020	500	200	0,07	31	10	24	285,00
23055025	M CAL50250	500	250	0,08	31	10	24	345,00
23056015	M CAL60150	600	150	0,08	31	10	24	281,00
23056020	M CAL6020	600	200	0,10	31	10	24	345,00
23056030	M CAL6030	600	300	0,16	31	10	24	469,00
23050404	M CAL80150	800	150	0,10	31	10	24	379,00
23058020	M CAL8020	800	200	0,10	31	10	24	479,00
23058030	M CAL8030	800	300	0,14	31	10	24	709,00
23058040	M CAL8040	800	400	0,20	31	10	24	915,00
23055053	M CALI10150	1000	150	0,12	31	10	24	494,00
23051020	M CALI1020	1000	200	0,12	31	10	24	625,00
23051030	M CALI1030	1000	300	0,16	31	10	24	815,00
23051050	M CALI1050	1000	500	0,24	31	10	24	1.235,00
23051220	M CALI2020	1200	200	0,14	42	10	24	805,00
23051230	M CALI2030	1200	300	0,14	42	10	24	1.145,00
23051520	M CALI5020	1500	200	0,16	42	10	24	1.029,00
23051530	M CALI5030	1500	300	0,16	42	10	24	1.405,00
23052020	M CAL2020	2000	200	0,22	42	10	24	1.400,00
23052030	M CAL2030	2000	300	0,30	42	10	24	1.750,00
23053020	M CAL3020	3000	200	0,30	42	10	24	2.980,00



Klassieke schuifmaat in speciaal staal. Met fijnafstelling en vastzetschroef. Gehard en geslepen. Matverchroomde schaal en nonius. Nonius 0,05mm. Geleverd in een houten opberghoos. Din 862.

Order nr.	Orig. nr.	Meet- lengte	Lengte bek	D	E	F	Prijs
		mm	mm	mm	mm	mm	€
23045009	M CALG5090	500	90	25	5	12	105,00
23045015	M CALG50150	500	150	25	5	12	158,00
23040108	M CALG50100	500	100	-	-	-	133,00
23040207	M CALG80125	800	125	-	-	-	360,00
23041012	M CALG10120	1000	120	-	-	-	308,00
23040306	M CALG10125	1000	125	-	-	-	407,00
23041015	M CALG10150	1000	150	32	10	18	411,00
23040405	M CALG150150	1500	150	-	-	-	659,00
23041520	M CALG15020	1500	200	48	15	18	675,00
23042020	M CALG2020	2000	200	48	15	20	1.029,00

Limit



Digitale schuifmaat in roestvrij staal. Absolute functie (nulpunt en tijdelijk relatief nulpunt). Het originele nulpunt blijft in geheugen na uitschakelen. DIN863. Batterij 3V - CR1632. Geleverd in een doos.

Order nr.	174230102	
Orig. nr.	CALDI150	
Lengte bekken	mm	40
Hoogte cijfers	mm	8
Meetbereik	mm	0 - 150
Aflezings	mm	0,01
Prijs	€	69,00

Limit



Digitale schuifmaat. Roestvrijstaal. mm/inch omstelbaar. Reset knop. Automatisch uit. DIN863. Batterij 3V type CR2032.

Order nr.	190140103	190140202	190140301
Orig. nr.	CAD150N	CAD200N	CAD300N
Meellengte	mm	150	200
Lengte bek	mm	40	40
Hoogte cijfers	mm	8	8
Resolutie	mm	0,01	0,01
Prijs	€	32,90	51,90

Limit



Digitale schuifmaat in roestvrij staal. Met extra-grote display en anti-slip duimgreep. DIN 862. Lengte 150mm. Gehard en geslepen. Met topspitsen en dieptemeter. On/off switch. Aflezings 0,01 mm - 0,0005". Mm/inch omstelbaar. Geleverd in een kunststof opbergdoos, zonder batterijen (batterij 1x SR44).

Order nr.	132330101	
Orig. nr.	SPD150B	
Meellengte	mm	150
Lengte bek	mm	40
Hoogte cijfers	mm	11
Schaalverdeling	mm	0,01
Prijs	€	59,90

Limit



Digitale schuifmaat in roestvrij staal. DIN 862. Water- en olie bestendig (IP67). Lengte 150mm. Gehard en geslepen. Met topspitsen en dieptemeter. On/off switch. Aflezings 0,01 mm - 0,0005". Mm/inch omstelbaar. Geleverd in een kunststof opbergdoos, zonder batterijen (batterij 1x SR44).

Order nr.	122560105	
Orig. nr.	SPD150	
Meellengte	mm	150
Lengte bek	mm	40
Prijs	€	168,00

Limit



Digitale schuifmaat in roestvrij staal. DIN 863. Lengte 150mm. Gehard en geslepen. Met topspitsen en dieptemeter. Automatische switch off. Aflezings 0,01 mm/0,0005"/1/128". Mm/inch/Inch breuk instelbaar. Geleverd in een kunststof opbergdoos, zonder batterijen (batterij 1x SR44).

Order nr.	144550100	144550209
Orig. nr.	SPD150C	CADTR200
Meellengte	mm	150
Lengte bekken	mm	40
Prijs	€	65,00



Digitale schuifmaat in roestvrij staal. DIN 862. Lengte 500 tot 1500mm (1500mm zonder schaal). Gehard en geslepen. Zonder topspitsen. On/off switch. Aflezing 0,01mm - 0,0005". Mm/ inch omstelbaar. Geleverd in een houten opbergdoos, zonder batterijen (batterij 1x SR44).

Order nr.	Orig. nr.	Meetlengte mm	Lengte bek mm	Prijs €
22890107 M	CALDI500	500	100	199,00
22890156 M	CALDI600	600	300	579,00
22890172 M	CALDI800	800	200	569,00
22890206 M	CALDI1000	1000	150	845,00
22899150 M	CALDI1500	1500	200	1.139,00



Digitale schuifmaat in roestvrij staal. Model voor linkshandigen. DIN 862. Lengte 150mm. Gehard en geslepen. Met topspitsen en dieptemeter. On/off switch. Aflezing 0,01mm - 0,0005". Mm/ inch omstelbaar. Geleverd in een kunststof opbergdoos, zonder batterijen (batterij 1x SR44).

Order nr.	Orig. nr.	Meetlengte mm	Lengte bek mm	Prijs €
	223000152 M			
Orig. nr.	CALDI150L			
Meetlengte	mm	150		
Lengte bek	mm	40		
Prijs	€			89,50



Vervangbatterijen 1,50V voor digitale meetinstrumenten. Type AG13-V357-SR44. Diam. 11,5 x 5.2mm.

Order nr.	Orig. nr.	Prijs €
	22899000 M	
Orig. nr.	BATTLR44	
Prijs	€	6,10



Vervangbatterijen 3,0V voor digitale meetinstrumenten. Type 2032. Diam. 19,8 x 3,0mm.

Order nr.	Orig. nr.	Prijs €
	109600304 M	
Orig. nr.	BATT2032	
Prijs	€	9,50

Spanningstesters



Spanningsdetector. Detecteert of er al of niet spanning (AC) aanwezig is. Geen contact vereist. LED lamp en zoemgeluid (afzetbaar) in geval van contact. Automatische of manuele off. Continue batterij-controle van de LED. Geleverd met handleiding, zonder batterijen. Veiligheidsisolatie : CAT IV 1000V.

Order nr.	Orig. nr.	Spanning	Batterij	Gewicht	Afmetingen (l x b x h)	Prijs €
	145010104 M	U1100	AC 90-1000 V	2x 1,5 AAA	0,09 kg	18 x 150 x 0
Prijs	€					17,90



U110

U112

Spanningstesters tot 690V. Met aanduiding van draaiveldrichting en onderscheid tussen fase en neutre. Test de werking van een aardlekschakelaar. Weergave van AC/DC spanning en doorgang (met buzzer). Aanduiding DC polariteit met + / -. Automatische on/off. Geleverd met testsnoerbescherming en handleiding, zonder batterijen. Veiligheidsisolatie CAT IV 600 V, IEC 61010. Beschermingsgraad IP65. Limit 110. Aanduiding voltage met LED-lampjes in 7 niveaus : 1-2-24-50-120-230-400-690V. Limit 112. Aanduiding van het reële voltage op een display en eveneens via de LED-lampjes in 7 niveaus (cfr. Limit 110).

Order nr.	Orig. nr.	Display	LED lampen	Spanning DC/AC	Gewicht	Afmetingen (l x b x h)	Prijs €
	144890100 M						
	144890209 M						
Orig. nr.	U110	Nee	✓	12-690	0,33 kg	260 x 56 x 20	47,50
Display							
LED lampen							
Spanning DC/AC							
Gewicht							
Afmetingen (l x b x h)							
Prijs	€						57,50

Stempelsets

Limit



Cijferstempelset. Bevat 9 stempels met de cijfers van 0 tot en met 9. 1733: Geharde graveerzone tot 58-60 HRC. 5175: Geharde graveerzone tot 60-61 HRC.

Order nr.	Orig. nr.	Hoogte cijfers	Schacht vierkant	Hardheid graveerzone	Aantal stuks	Prijs
		mm	mm	HRC		€
17330101	CSS2	2	6	58-60	9	18,00
17330200	CSS3	3	6	58-60	9	18,00
17330309	CSS4	4	7	58-60	9	18,00
17330408	CSS5	5	8	58-60	9	22,50
17330507	CSS6	6	9	58-60	9	22,50
17330606	CSS8	8	11	58-60	9	34,90
17330705	CSS10	10	12	58-60	9	62,90
17330804	CSS12	12	14	58-60	9	69,00
17330903	CSS15	15	16	58-60	9	117,00
51750107	CSSXL2	2	7	60-61	9	62,00
51750206	CSSXL3	3	8	60-61	9	62,00
51750305	CSSXL4	4	9	60-61	9	68,90
51750404	CSSXL5	5	10	60-61	9	72,50
51750503	CSSXL6	6	12	60-61	9	91,50
51750602	CSSXL8	8	14	60-61	9	112,00
51750701	CSSXL10	10	16	60-61	9	144,00

Limit



Letterstempelset. Bevat de 26 letters van A tot Z en het teken en . 1735 : Geharde stempelzone tot 60-63 HRC . 5176 : Geharde stempelzone tot 60-61 HRC.

Order nr.	Orig. nr.	Schacht vierkant	Hardheid graveerzone	Aantal stuks	Hoogte letters	Prijs
		mm	HRC		mm	€
17350109	STA2	6	60-63	26	2	44,50
17350208	STA3	6	60-63	26	3	44,50
17350307	STA4	7	60-63	26	4	44,50
17350406	STA5	8	60-63	26	5	61,00
17350505	STA6	9	60-63	26	6	60,90
17350604	STA8	11	60-63	26	8	95,00
17350703	STA10	12	60-63	26	10	128,00
17350802	STA12	14	60-63	26	12	208,00
17350901	STA15	16	60-63	26	15	328,00
51760106	STAL2	7	60-61	26	2	175,00
51760205	STAL3	8	60-61	26	3	185,00
51760304	STAL4	9	60-61	26	4	195,00
51760403	STAL5	10	60-61	26	5	213,00
51760502	STAL6	12	60-61	26	6	286,00
51760601	STAL8	14	60-61	26	8	324,00
51760700	STAL10	16	60-61	26	10	432,00

Limit



Complete stempelset met stempelhouder bestaande uit 58 letters, 35 cijfers en 7 speciale merktekens

Order nr.	Orig. nr.	Hoogte mm	Capaciteit houder	Lengte mm	Prijs
					€
58890104	STS3	3	10	40	745,00
58890203	STS4	4	8	40	799,00
58890302	STS5	5	6	40	845,00

Limit



Letter- en cijfersjablonen. Met sluitgroef voor assemblage. De cijferset bevat 15 stempels waaronder cijfers van 0 tot en met 9, een koppelteken, een extra nul, een punt en twee eindstukken. De letterset, bevat 36 stempels waaronder letters van A tot en met Z, een koppelteken, een punt, een en-teken, een spatie en twee eindstukken. De stempels worden enkel verkocht in volledige sets.

Order nr.	Orig. nr.	Hoogte teken mm	Type	Aantal	Prijs
					€
17320102	CC25	25	Cijfer	15	30,90
17320409	CC38	38	Cijfer	15	38,50
17320607	CC50	50	Cijfer	15	46,50
17320805	CC62	62	Cijfer	15	54,50
17321209	CC78	75	Cijfer	15	73,50
17321258	CC100	100	Cijfer	15	108,00
17321308	CAL25	25	Letter	36	86,50
17321605	CAL38	38	Letter	36	102,00
17321803	CAL50	50	Letter	36	124,00
17322009	CAL62	62	Letter	36	135,00
17322405	CAL75	75	Letter	36	173,00
17322454	CAL100	100	Letter	36	199,00

Tachometers

Limit



Digitale tachometer. Geschikt voor foto-meten en voor contact-meten. Meetafstand voor foto-meten: 50-150mm. Het geheugen houdt de laatst gemeten waarde, minimum waarde en maximum waarde bij. Geleverd zonder batterijen.

Order nr.	132370107	
Orig. nr.	R2000	
Batterij	4x 1,5V LR06	
Bereik: contact	m/min	0,05-2000
Bereik: foto	rpm	2,5-100000
Gewicht	kg	0,35
Afmetingen (l x b x h)	mm	124 x 35 x 20
Prijs	€	147,00

Limit



Accessoires voor R2000.

Order nr.	132370206	132370305
Orig. nr.	R2000TA	R2000ACC
Omschrijving	reflecterende tape	3 meetpunten
	5x350 mm	
Gewicht	kg	0,01
Prijs	€	8,50
		11,50

Limit



Tachometer Limit 2200.

Digitale tachometer/teller met optische contactloze aflezing. Richt de laser spot op een reflecterende tape of andere contrasterende oppervlakte van het roterende voorwerp en lees het toerental. Afwisselend het aantal getelde items tijdens een metingperiode. De gemeten waarde kan vergrendeld worden en het apparaat geeft de min.-max. waarden en de gemiddelde waarde. Geleverd met reflecterende tape, batterij en handleiding.

Extra reflecterende tape 5x350 mm 13237-0206.

Order nr.	198620106
Orig. nr.	L2200
Afstandbereik	mm 50-200
Batterij	4pcs. 1.5V AA
Bereik: contact	m/min 10-99999
Nauwkeurigheid	0.05% + 2 digits
Batterij	V 1.5
Gewicht	kg 0,10
Afmetingen (l x b x h)	mm 184 x 56 x 34
Prijs	€ 116,00

Thermometers

Limit



Infrarood thermometer voor het meten van buitentemperatuur zonder contact. Gecombineerd met een lamp aan de tegenovergestelde kant. Automatische shut-off na 15 seconden. Richt het apparaat naar een voorwerp en druk vervolgens op het knopje. Lees de temperatuur op de display. Geleverd zonder batterijen.

Order nr.	131560104
Orig. nr.	LITH80
Batterij	5x SR44/LR1154
Meetbereik	°C -33 - +110
Nauwkeurigheid	+/-2,5°C alternatief +/-2,5°C
Type	80
Resolutie	°C 0,2
Gewicht	kg 0,16
Prijs	€ 67,00

Limit



L91

L92

Infrarood afstandsthermometer voor het meten van de meeste oppervlaktes. Automatisch shut-off na 6 seconden. Laser straal met on/off knop. Verstelbaar tussen °C en °F. Verlichte display. Limit 92en93: met USB datatransfer fiche en kabel.

Waarschuwing bij bijna-lege batterij. Geleverd zonder batterijen.

Order nr.	153180104	153190103	153190202
Orig. nr.	L91	L92	L93
Batterij	1 x 9V 6F22	1 x 9V 6F22	1 x 9V 6F22
Emissiviteit	vast 0,95%	0,10 - 1,00	0,10 - 1,00
Meetafstand	1 : 10	1 : 12	1 : 30
Nauwkeurigheid	2°C of 2%	1,8°C of 1,8%	1,8°C of 1,8%
Opslagtemperatuur	°C -20 - +65	-20 - +65	-20 - +65
Temperatuur	°C -18 - +380	-18 - +550	-32 - +1050
Werktemperatuur	°C 0-50	0-50	0-50
Resolutie	°C 0,1	0,1	0,1
Gewicht	kg 0,08	0,52	0,52
Prijs	€ 105,00	189,00	409,00

Limit



Digitale thermometer. Geschikt om oppervlaktes, gas en vloeistof te meten. Twee inputs om te werken met 2 voelers tegelijkertijd. Er kunnen tot 99 metingen opgeslagen worden. Met display die max-min-gemiddelde en waardeverschil tussen de 2 voelers weergeeft. Met verlichte display. Verstelbaar tussen °C en °F. Waarschuwing bij lege batterij. Geschikt voor voelers type K, J en E. Geleverd met voeler type K max 260°C, pc kabel met software en handleiding. Geleverd zonder batterijen.

Order nr.	153210109
Orig. nr.	L60
Batterij	1 x 9V 6F22
Opslagtemperatuur	°C -40 - +60
Werktemperatuur	°C -10 - +50
Resolutie	°C 0,1
Gewicht	kg 0,45
Afmetingen (l x b x h)	mm 175 x 8 x 30
Prijs	€ 132,00



Accessoires voor thermometer Limit 60.

Order nr.	Orig. nr.	Omschrijving	Prijs €
153210208	M LIM60AIRFLU	voeler voor lucht en vloeistof type K -50 - +600°C, lengte voeler 180mm, lengte kabel 1000mm	55,50
153210307	M LIM60SURF	voeler voor oppervlakte type K -50 - +500°C, lengte voeler 125mm, lengte kabel 1000mm	61,50
128600301	M LIM300SENS	kabel voeler type K -50 - +260°C, lengte kabel 900mm	8,50
198660102	M L500SB	opbergzak	16,90



Infrarood afstandthermometer met camera. Meet ook de omgevingstemperatuur, vochtigheid en berekent het dauwpunt. Een thermokoppel sensor type K kan aangesloten worden, om bijvoorbeeld een ander oppervlak of in een andere omgeving, of om de emissiefactor te controleren/aan te passen. Zeer enge IR-straal, 1:50, maakt de metingen heel betrouwbaar, zelfs bij kleine meetvlakken. Twee laserpunten markeren de meetpunten. De 2,7" LCD kleurmonitor toont het meetbereik, het meetpunt, en alle meetgegevens. Slaat max.-min. en gemiddelde op. Zowel stilstaande als bewegende beelden kunnen worden opgeslagen en daarna op het scherm afgespeeld of op een PC gedownload. Geen software nodig. Een USB kabel verbindt de thermische camera rechtstreeks met uw PC. Ingebouwde oplaadbare batterij. Geleverd met geheugenkaart 2G, USB kabel, batterijlader en handleiding. De sensor type K is niet inbegrepen.

Order nr.	190380105 M		
Orig. nr.	L96		
Afmetingen	mm	210 x 150 x 86	
Bereik IR	°C	-40... +1000	
Bereik type K	°C	-40 - +1000	
Dauwpunt	°C	0... 50	
Emissiviteit		0,10-1,00	
Herhaalbaarheid	30 - 1000 °C	+/-0,5%	
Minimum aflezing meetpunt-afstand	mm	2	
Nauwkeurigheid (0 - 1370 °C)	°C	+/-0,5% +1,5°C	
Omgevingstemperatuur	°C	0... 50	
Vochtigheid	RH%	0... 100	
Gewicht	kg	0,52	
Prijs	€	459,00	

Vibrometers



Vibrometer Limit 4800. Voor de controle van machines, elektrische en pneumatische werktuigen. Het meten van vibraties is een middel om ergonomische letsels te voorkomen, en om het onderhoud van machines te voorzien. Gemakkelijk te gebruiken: bevestig de sensor op de machine, druk op de knop, en lees de aangeduide waarde. Geleverd met sensor en handleiding.

Order nr.	190370106 M	
Orig. nr.	LIMIT4800	
Afmetingen	mm	160 x 68 x 30
Diameter sensor	mm	25
Minimum aflezing		1
Snelheid	mm/s	0 - 200
Verplaatsing	µm	2000
Versnelling	m/s ²	0 - 199
Gewicht	kg	0,20
Afmetingen (l x b x h)	mm	160 x 68 x 30
Prijs	€	463,00

Vlaktafels

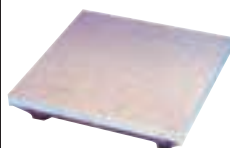

Gietijzeren vlaktafel. Stabiele constructie. Conform DIN 876/1.

Order nr.	190170409 M	
Orig. nr.	VP400600	
Gewicht	kg	42,00
Afmetingen (l x b x h)	mm	600 x 400 x 65
Prijs	€	442,00

Voelermaten



Hoekvoelermaten. Voor het meten van diverse hoeken.

Order nr.	25861006 M	
Orig. nr.	ANGGA45	
Aantal bladen		18
Voor hoeken	°	1 - 2 - 3 - 4 - 5 - 6 - 7 - 8 - 9 - 10 - 12 - 14 - 16 - 18 - 20 - 25 - 30 - 40 - 45
Prijs	€	34,90

Limit



Voelermaat voor boren en tappen. Intervallen met een stap van 0,1 mm. Aantal gaten 100.

Order nr.	25900309 <small>M</small>	
Orig. nr.	DRIGA10	
Diameter	mm	0,1 - 10
Intervallen	mm	0,1
Aantal gaten	100	
Dikte	mm	2
Prijs	€	230,00

TENGOOLS



Voelermaat. Gehard en gewalst staal. Lengte 75mm. 20 stalen bladen.

Order nr.	116860107 <small>T</small>	
Orig. nr.	FG21	
Aantal bladen	21	
Meetbereik	mm	0,05 - 1,00
Niet-magnetisch brons-blad	mm	0,10
Prijs	€	13,90

Limit



Voelermaat. Gehard en gewalst staal. Breedte 12,7mm.

Order nr.	Orig. nr.	Aantal bladen	Meetbereik mm	Lengte bladen mm	Prijs €
25953001 <small>M</small>	FG10081	8	0,03 - 0,10	100	3,70
25953100 <small>M</small>	FG10085	8	0,05 - 0,50	100	3,90
25953209 <small>M</small>	FG100215	21	0,10 - 0,50	100	8,30
25953308 <small>M</small>	FG100131	13	0,05 - 1,00	100	4,20
25959014 <small>M</small>	FG100261	26	0,03 - 1,00	100	10,50
25953407 <small>M</small>	FG100201	20	0,05 - 1,00	100	7,30
25950601 <small>M</small>	FG10010	20	0,10 - 2,00	100	24,50
25953506 <small>M</small>	FG200131	13	0,05 - 1,00	200	11,50
25953605 <small>M</small>	FG200201	20	0,05 - 1,00	200	16,50
25951104 <small>M</small>	FG200202	20	0,10 - 2,00	200	43,90

Limit



Voelermaat. Gehard en gewalst staal. Breedte 10mm. 6 bladen. Speciaal model voor het afregelen van motorkleppen.

Order nr.	25959015 <small>M</small>	
Orig. nr.	FG75	
Aantal bladen	6	
Meetbereik	mm	0,10 - 0,40
Lengte bladen	mm	75
Prijs	€	3,00

Limit



Voelermaat. Gehard en gewalst staal. Breedte 12,7mm.

Order nr.	25971003 <small>M</small>	
Orig. nr.	FG300	
Aantal bladen	13	
Meetbereik	mm	0,05 - 1,00
Lengte bladen	mm	300
Prijs	€	15,50

Limit



Voelermaat. Gecalibreerd DIN 2275. Gehard en gewalst staal. Met ingesloten certificaat. Gecalibreerd op 2 meetpunten per blad.

Order nr.	25952003 <small>M</small>	25952102 <small>M</small>	25952201 <small>M</small>
Orig. nr.	FGAL81	FGAL131	FG100201C
Aantal bladen	8	13	20
Meetbereik	mm	0,03 - 0,10	0,05 - 1,00
Bladlengte	mm	100	100
Prijs	€	43,50	70,90
			108,00

Limit



Voelermaat. Messing. Breedte 12,7mm.

Order nr.	Orig. nr.	Aantal bladen	Schaalverdeling mm	Bladlengte mm	Prijs €
67921007 <small>M</small>	FGM5	8	0,05 - 0,50	100	10,90
67921106 <small>M</small>	FGM131	13	0,05 - 1,00	100	15,90
67921205 <small>M</small>	FGM201	20	0,05 - 1,00	100	23,90
67920306 <small>M</small>	FGM1NE	20	0,05 - 1,00	100	24,00



Voelerstrips. Koudgewalste, geharde en witgepolierde stalen band. Afmeting gemarkeerd elke 150mm. Lengte 3m. Breedte 13mm.

Order nr.	Orig. nr.	Bladdikte mm	Tolerantie mm	Prijs €
25990102	VB02	0,02	+/- 0,004	19,90
25990201	VB03	0,03	+/- 0,004	14,50
25990300	VB04	0,04	+/- 0,004	14,50
25990409	VB05	0,05	+/- 0,004	11,50
25990508	VB06	0,06	+/- 0,004	10,50
25990607	VB07	0,07	+/- 0,004	10,50
25990706	VB08	0,08	+/- 0,004	9,80
25990805	VB09	0,09	+/- 0,004	9,80
25990904	VB10	0,10	+/- 0,005	9,80
25991308	VB15	0,15	+/- 0,005	9,80
25991506	VB20	0,20	+/- 0,007	9,80
25991605	VB25	0,25	+/- 0,008	9,80
25991704	VB30	0,30	+/- 0,009	9,80
25991902	VB35	0,35	+/- 0,009	12,90
25992009	VB40	0,40	+/- 0,011	12,90
25992108	VB45	0,45	+/- 0,011	13,50
25992207	VB50	0,50	+/- 0,013	15,50
25992405	VB60	0,60	+/- 0,015	15,50
25992504	VB70	0,70	+/- 0,015	18,50
25992702	VB80	0,80	+/- 0,017	20,50
25992801	VB90	0,90	+/- 0,017	24,90
25992900	FEESTRI1	1,00	+/- 0,017	24,90



Houder voor voelerstrips type 2599. Lengte 135mm. Breedte 13mm.

Order nr.	26000109
Orig. nr.	FEESTRIHO
Prijs	€ 8,30



Vlakte voelermaat. Wordt gebruikt bij het visueel vaststellen van ruwe oppervlaktes of het voelen met de vingertop. 6 verschillende bewerkingsmethodes, elk met 6 Ra waarden.

Order nr.	53700100
Orig. nr.	SURFGAU
Polieren, ruimen, vlakschuren	Ra 1,6 - 0,8 - 0,4 - 0,2 - 0,1 - 0,005
Horizontaal frezen, vlakdraaien, langsdraaien	Ra 12,5 - 6,3 - 3,2 - 1,6 - 0,8 - 0,4
Prijs	€ 226,00

V-blokken



Set van 2 V-blokken. Werkplaatskwaliteit. Geslepen. Per paar. Uniformiteit en parallelisme +/- 0,03mm. Hoek V-groef: 90°.

Order nr.	Orig. nr.	Breedte mm	Hoogte mm	V-groef		Prijs €	
				Dikte mm	Diepte mm		
25020108	VBL7503	75	60	32	44	23	44,50
25020207	VBL10003	100	65	41	50	28	57,50
25020405	VBL15003	150	90	63	82	39	122,00
25020603	VBL20003	205	140	100	100	56	279,00



Set van 2 V-blokken. Uit speciaal staal. Geslepen, bewerkt en genummerd per paar. ingangshoek 90°. Uniformiteit en parallelisme +/- 0,008mm.

Order nr.	Orig. nr.	Lengte mm	Afmetingen vierkant mm	Diameter V-groef mm	Prijs
					€
121700075	VBL75008	75	40	5-40	108,00
121700100	VBL100008	100	45	6-45	135,00
121700150	VBL150008	150	55	8-55	221,00



Set van 2 V-blokken. Met 2 spanbeugels. Uit speciaal staal. Geslepen, bewerkt en genummerd per paar. 2 ingangshoeken 90°. Uniformiteit en parallelisme +/- 0,01mm.

Order nr.	Orig. nr.	Maximum diameter klemmen mm	Prijs €
52520202	VBL2501	25	47,50
52520301	VBL3501	37	51,50
52520400	VBL7501	40	138,00



Set van 2 V-blokken. Met 2 spanbeugels. Uit speciaal staal. Geslepen, bewerkt en genummerd per paar. 2 ingangshoeken 90°. Uniformiteit en parallelisme +/- 0,008mm. Din 876/0

Order nr.	Orig. nr.	Voor assen diameter mm	Prijs €
121800045	VBL45008	5-20	108,00
121800070	VBL7025008	5-25	137,00
121800071	VBL7032008	5-32	206,00
121800125	VBL125008	5-45	275,00

Waterpassen

TENGOOLS



SLA040. Waterpas in aluminium.
Nauwkeurigheid 1.0 mm/m.

Order nr.	173260100	
Orig. nr.	SLA040	
Lengte	mm	400
Prijs	€	14,00

Limit



Mini digitale waterpas en gradenboog. De display duidt twee waarden aan: een absolute waarde en een relatieve waarde. Gekantelde display voor een duidelijke aflezing. Nulstelling in elke positie. Magneet op de basis voor bevestiging op zaagblad, stalen frame, enz. Schakelt automatisch uit na 3 minuten. 2 batterijen AAA 1,5V niet meegeleverd.

Order nr.	174250209	
Orig. nr.	WPD10	
Bereik	0 - 180	
Minimum aflezing	0,1	
Nauwkeurigheid	+/- 0,3	
Stof- en waterdicht	IP 54	
Prijs	€	52,50

Limit



Digitale precisie waterpas. Aflezing 0-90°. Alternative hoek 0-100%. Kan in alle posities gebruikt worden. Vastzetten van de gemeten waarden. Display draait wanneer pas met 180° gedraaid wordt. Verlichte display. Met automatische uitschakeling na 3 minuten. Geleverd zonder batterijen.

Order nr.	174260109	
Orig. nr.	DW150	
Graden	4x90°	
Lezingshoek	0-100%	
Resolutie	mm	0,1°
Nauwkeurigheid	+/- 0,3°	
Batterijen	1x3V CR2032	
Afmetingen	mm	150x50x33
Prijs	€	105,00

Limit



0749



12187

Machine precisiewaterpas. Gemaakt uit hoogwaardig gietijzer staal. Met prisma-basis. Met verticaal en horizontaal waterpas. DIN 877.

Order nr.	Orig. nr.	Lengte	Schaalverdeling	Nauwkeurigheid	Prijs
		mm	mm/m	mm	€
07490055	WP100	100	0,05	0,025	141,00
07490154	WP150	150	0,05	0,025	138,00
07490204	WP2001	200	0,10	0,025	153,00
07490402	WP20002	200	0,02	0,005	153,00
121870300	WP300	300	0,02	0,02	255,00

Limit



Raamwaterpas. Gietijzer. Nauwkeurig geslepen. Groef V-geslepen. Instelbare hellingmeter. DIN 877.

Order nr.	Orig. nr.	Lengte	Hoogte	Schaalverdeling	Nauwkeurigheid	Prijs
		mm	mm	mm/m	mm/m	€
07570039	RWP100	100	100	0,05	0,025	203,00
07570054	RWP150	150	150	0,05	0,025	203,00
07570104	RWP2001	200	200	0,10	0,025	203,00
07570203	07570203	200	200	0,02	0,005	278,00



Winkelhaken



Winkelhaak. Platte uitvoering. Werkplaatsstaal. Verzinkt. Vervaardigd uit 1 stuk. (1250-1500-2000mm : gepolierd - niet-verzinkt.)

Order nr.	Orig. nr.	Lang been mm	Kort been mm	Prijs €
25389010 M	WHP10070	100	70	7,50
25389020 M	WHP150100	150	100	8,20
25380304 M	WHP200130	200	130	9,50
25389030 M	WHP250160	250	165	10,50
25380502 M	WHP300180	300	180	11,50
25389040 M	WHP400230	400	230	13,50
25380700 M	WHP500280	500	280	16,90
25380809 M	WHP600330	600	330	22,50
25389050 M	WHP750375	750	375	25,90
25381005 M	WHP5001000	1000	500	38,50
25389060 M	WHP1250625	1250	625	67,50
25381104 M	WHP1500750	1500	750	125,00



Winkelhaak. Platte uitvoering. DIN 875/2. Werkplaatsstaal. Verzinkt.

Order nr.	Orig. nr.	Lang been mm	Kort been mm	Prijs €
25331505 M	WHVL7550	75	50	13,50
25331604 M	WHVL10070	100	70	13,50
25331703 M	WHVL150100	150	100	20,50
25331802 M	WHVL200130	200	130	28,50
25339250 M	WHVL250	250	165	23,00
25331901 M	WHVL300200	300	200	58,50
25339500 M	WHVL500	500	250	60,50
25332008 M	25332008	400	265	75,50



Winkelhaak. Uitvoering met voet. Werkplaatsstaal. Vervaardigd uit 1 stuk. Din 875/2.

Order nr.	Orig. nr.	Lang been mm	Kort been mm	Prijs €
25342007 M	WH210075	100	70	24,50
25342106 M	WH2200130	200	130	39,00
25342205 M	WH2300200	300	200	67,90
25342304 M	WH2400265	400	265	128,00



Winkelhaak. Uitvoering met voet. Werkplaatsstaal. Verzinkt. Vervaardigd uit 1 stuk. (1250mm : gepolierd - niet-verzinkt.)

Order nr.	Orig. nr.	Lang been mm	Kort been mm	Prijs €
25341000 M	WHV10070	100	70	10,50
25341500 M	WHV150100	150	100	12,50
25342000 M	WHV200130	200	130	14,90
25342500 M	WHV250160	250	165	17,50
25343000 M	WHV300180	300	180	21,50
25344000 M	WHV400230	400	230	25,50
25455000 M	WHV500280	500	280	33,90
25456000 M	WHV600330	600	330	47,50
25457500 M	WHV750375	750	375	54,50
25450100 M	WHV5001000	1000	500	74,50
25450125 M	WHV1250625	1250	625	163,00



Winkelhaak. Uitvoering met voet. DIN 875/2. Werkplaatsstaal. Verzinkt.

Order nr.	Orig. nr.	Lang been mm	Kort been mm	Prijs €
120110075 M	WH275	75	50	13,50
120110100 M	WH2100	100	70	15,00
120110150 M	WH2150	150	100	21,00
120110200 M	WH2200	200	130	24,50
120110250 M	WH2250	250	165	34,00
120110300 M	WH2300	300	175	43,50
120110400 M	WH2400	400	200	71,00
120110500 M	WH2500	500	250	90,50



Verstelbare winkelhaak. Geslepen staal. Verzinkt. Met vastzetschroef.

Order nr.	25449010 M	25449020 M
Orig. nr.	WHG150	WHG250
Lengte been	mm 150	250
Prijs	€ 17,90	24,50



Blokwinkelhaak. Uit speciaal staal. DIN 875/2. Met zware blok-basis. Geslepen aan beide zijden.

Order nr.	Orig. nr.	Lang been mm	Kort been mm	Prijs €
25319100 M	BWH10070	100	70	22,50
25319125 M	BWH12575	125	75	24,50
25319150 M	BWH150100	150	100	29,50
25319200 M	BWH200130	200	130	39,50
25319250 M	BWH250160	250	160	48,90
25319300 M	BWH300200	300	200	54,50



Winkelhaak met scherpe hoeken. Gehard staal. Gepolierde hoeken. DIN875/00.

Order nr.	52171402 M			
Orig. nr.	WH875/00			
Lang been	mm	200		
Kort been	mm	130		
Prijs	€	60,50		



Hartzoeker. Werkplaatsstaal. Kan worden gebruikt als blokwinkelhaak of T-haak. Graduatie in mm. Matverchromd. Te gebruiken voor markeren van centers, plateninden of ronde stukken.

Order nr.	Orig. nr.	Lengte blad mm	Lengte basis mm	Voor assen diameter mm	Prijs €
25429100 M	HZ10070	100	70	90	40,50
25429150 M	HZ150130	150	130	200	47,50
25420209 M	HZ200150	200	150	220	65,00
25429250 M	HZ250160	250	160	230	88,00
25429300 M	HZ300180	300	180	280	114,00



Verstelbare stop op gegradueerde metalen maatlat. Tolerantie volgens DIN 875/2.

Order nr.	151250107 M		151250206 M	
Orig. nr.	WHLA10070		WHLA150100	
Lengte winkelhaak	mm	100	150	
Lengte aanpasbare stop	mm	70	100	
Prijs	€	19,00	21,50	



Gecombineerde winkelhaak. Met gradenbooghoek en middelpuntzoeker. Waterpas op de hoekmeter en gradenboog. Maatlat is gegradueerd aan beide zijden in mm en inch. Eenvoudig om hoogte, diepte en de 45° - 135° hoek of center te meten.

Order nr.	119180107 M	
Orig. nr.	CWH3	
Gradenboog	°	0-180
Meetlat lengte	mm	300
Hoekmeter	mm	110
Middelpuntzoeker	mm	63
Prijs	€	85,00



Set van 12 hoekplaten. Voor meting, inspectie en instellen van machines, snijgereedschappen of gradenboog. In kwaliteitsstaal, geaard en gehard. De platen zijn licht magnetisch zodat ze makkelijk kunnen geplaatst worden. Nauwkeurigheid van de hoek +/- 0,01mm per 100mm. Geleverd in een stevige plastic doos.

Order nr.	153230107 M	
Orig. nr.	LIPH12	
Hoek	°	1/4 - 1/2 - 1 - 2 - 3 - 4 - 5 - 10 - 20 - 25 - 30
Lengte	mm	76
Prijs	€	90,50



Gecombineerd precisie winkelhaak. Verschuifbare en vastzetbare middelpuntzoeker en rechte hoek. Met waterpas op hoekmeter. 300mm maatlat is gegradueerd aan beide zijden mm en inch. Met kraspen.

Order nr.	61380101 M	
Orig. nr.	CWH3002	
Prijs	€	339,00



Gecombineerde winkelhaak. Met verschuifbare gradenbooghoek en middelpuntzoeker. Waterpas op hoekmeter en gradenboog. Maatlat is gegradueerd aan één zijde in mm en aan andere zijde in inch. Met kraspen.

Order nr.	61390100 M	
Orig. nr.	CWH3003	
Gradenboog	°	0-180
Meetlat lengte	mm	300
Hoekmeter	mm	110
Prijs	€	565,00



Vlakke winkelhaak.
Gereedschapsstaal. Geslepen kanten.

Order nr.	190150409 ^M
Orig. nr.	WH2000
Lang been	mm 2000
Kort been	mm 1000
Prijs	€ 304,00



Winkelhaak + voet 750 mm DIN 875/2.

Order nr.	120110750 ^M
Orig. nr.	WH2750
Lang been	mm 750
Kort been	mm 375
Prijs	€ 133,00



Winkelhaak 100x70mm Workshop Quality. DIN 875/2.

Order nr.	162460208 ^M
Orig. nr.	WHBL10070
Lang been	mm 100
Kort been	mm 70
Lengte basis	mm 20x9
Lengte been	mm 20x1.5
Prijs	€ 18,50



Blokwinkelhaak. Uit speciaal staal. DIN 875/1. Met zware blok-basis. Geslepen aan beide zijden.

Order nr.	25301706 ^M
Orig. nr.	WHBL875/1
Lang been	mm 400
Kort been	mm 265
Prijs	€ 137,00

Weegschalen



Weegschaal met wijzerplaat en analoge display. Voor magazijnen, burelen en bedrijven, etc.. Roesvrij stalen weegplaat en omkasting. Grote en gemakkelijke te lezen schaal met veiligheidsglas. Nulpunt instelling tot ongeveer 5 % van de capaciteit.

Order nr.	28000107	28000305	28000404
Orig. nr.	LKC38 ^M	LKC430 ^M	LKC450 ^M
Capaciteit	kg 8	30	50
Gradatie	g 20	100	200
Afmetingen weegplaat	mm 196x310	255x310	270x350
Gewicht	kg 3,00	6,50	11,00
Prijs	€ 179,00	305,00	305,00



Hangweegschaal voor verschillende toepassingen. Kc serie : analoog met acrylaat beschermglas, vijs voor nul positie (tarra).

CLH4 serie : electronisch met 14mm grote digits en sneltoets voor tarra positie. Haak en oog in staal. totale lengte 342 mm. Batterijen inclusief (2x1.5V).

Order nr.	Orig. nr.	Capaciteit	Gradatie	Gewicht	Prijs
		kg	g	kg	€
27970102 ^M	LKC0825	25	100	1,20	129,00
27970300 ^M	LKC0850	50	200	1,30	129,00
27970409 ^M	LKC08100	100	500	1,30	129,00
27970557 ^M	LKC230	200	500	3,80	549,00
27970607 ^M	LKC11	250	1000	3,30	249,00
27970615 ^M	CLH430	30	20	0,50	189,00
27970623 ^M	CLH460	60	50	0,50	189,00
27970706 ^M	CLH4150	150	100	0,50	189,00
27970805 ^M	CLH4300	300	200	0,50	189,00

Limit



NEW

Precisie weegschaal.
Compact tafel model met digitaal display met grote en gemakkelijk te lezen cijfers, Functies : on/off, tarreren,tellen, weegeenheden..RVS weegplaat met beschermend deksel.
LEM 7-0.5 touch display achtergrond verlichting . Batterij gevoed 2x1.5V type AAA (incl.).
LEM7-10 precisie weegschaal, geleverd met netadapter 230V.

Order nr.		168900108 M	168900207 M
Orig. nr.		LEM705	LEM710
Capaciteit	kg	0,50	10
Gradatie	g	0,1	1
Nauwkeurigheid	g	0,1	1
Afmetingen weegplaat	mm	60x60	170x180
Gewicht	kg	1,20	1,44
Prijs	€	69,00	205,00

Limit

NEW



Elektronische pakjes weegschalen met digiaal display. Display en RVS weegplaat afzonderlijk. De weegschaal kan vrijstaand worden gebruikt of aan de muur. Duidelijk onder hoek gezette display met 25mm hoge digits met achtergrond verlichting. Nulfunctie,weeg unit, tarra, netto/bruto. Oplaadbare batterij (werkzaam 80 uur) of netstroom gevoed.

Order nr.	Orig. nr.	Gradatie	Nauwkeu- righeid	Afmetingen weegplaat	Ge- wicht	Prijs
		kg	g	mm	kg	€
109290031 M	LE230	30	10	315x325	38,00	299,00
109290056 M	LE260	60	20	315x325	38,00	299,00
109290072 M	LE2150	150	50	315x325	38,00	309,00
109290098 M	LE3150	150	50	450x350	68,00	409,00
109290197 M	LE4300	300	100	600x600	124,00	579,00

Slangklemmen

Slangklemmen



RVS

100-delige Jubilee display van roestvrijstalen slangklemmen bestaande uit 10 x 10 verschillende maten.

Order nr.	745661001 €
Aantal stuks	100
Bevat	10 stuks elks 9,5-12 / 11-16 / 13-20 / 16-22 / 18-25 / 22-30 / 25-35 / 30-40 / 35-50 / 40-55mm
Prijs	€ 260,00



VERZINKT STAAL

143-delige set van staalverzinkte standaard slangklemmen in stevige ABS-koffer.

Order nr.	745661430 €
Aantal stuks	143
Bevat	24 x 9,5-12 / 32 x 11-16 / 28 x 13-20 / 13 x 16-22 / 14 x 18-25 / 12 x 22-30 / 13 x 25-35 / 7 x 30-40mm
Prijs	€ 136,00

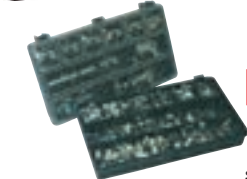

VERZINKT STAAL

165-delige set JUNIOR slangklemmen in stevige ABS-koffer.

Order nr.	745661650 €
Aantal stuks	165
Bevat	25 x 7-9 / 25 x 8-10 / 25 x 9-11 / 30 x 10-12 / 30 x 11-13 / 30 x 12-14mm
Prijs	€ 89,00



VERZINKT STAAL

175-delige set O-CLIPS slangklemmen in stevige ABS-koffer.

Order nr.	745661750 €
Aantal stuks	175
Bevat	20 x 5-7 / 20 x 7-9 / 20 x 8-11 / 20 x 9-11 / 20 x 11-13 / 15 x 13-15 / 20 x 15-17 / 20 x 15-18 / 20 x 17-20mm
Prijs	€ 77,50



VERZINKT STAAL

Stalen slangklemmen. Light versie. Verzinkte uitvoering. Breedte 9,9 mm. Banddikte 0,76mm. Conform DIN 3017 norm. VE = verpakkingseenheid.

Order nr.	Capaciteit mm	Band-breedte mm	Band-dikte mm	Z maximum mm	VE	Prijs/VE €
745681304	14-22	9,9	0,76	24	20	18,00
745681405	16-25	9,9	0,76	24	20	18,00
745681506	22-30	9,9	0,76	24	20	19,00
745681607	20-32	9,9	0,76	24	20	19,00
745681708	25-35	9,9	0,76	28	20	20,90
745681809	30-40	9,9	0,76	28	20	20,90
745681910	35-45	9,9	0,76	28	20	20,90
745682011	35-50	9,9	0,76	28	20	22,90
745682112	40-55	9,9	0,76	33	20	22,90
745682213	45-60	9,9	0,76	33	20	24,00
745682314	55-70	9,9	0,76	33	20	25,00
745682415	60-80	9,9	0,76	33	1	1,46
745682516	70-90	9,9	0,76	33	1	1,46
745682617	80-100	9,9	0,76	33	1	1,69
745682718	90-110	9,9	0,76	33	1	1,69
745682819	100-120	9,9	0,76	33	1	1,80
745682920	110-130	9,9	0,76	33	1	1,92
745683021	120-140	9,9	0,76	33	1	1,92
745683122	130-150	9,9	0,76	33	1	2,03
745683223	140-160	9,9	0,76	33	1	2,14



VERZINKT STAAL

Stalen slangklemmen. Standaard versie. Verzinkte uitvoering. Breedte 13mm. (9mm voor kleine maten) Conform BS7479 48 Hrs. NSS. Band BS1449RCSH 4BR. 620-740N-mm2. Huis BS1449RCSS03BR. Schroef BS970220M07. VE = verpakkingseenheid.

Order nr.	Capaciteit mm	Band-breedte mm	Doos nummer	Z maximum mm	VE	Prijs/VE €
745731001	9,5-12	9	OOO	21	10	8,50
745731102	11-16	9	MOO	21	10	8,50
745731203	13-20	9	OO	21	10	9,00
745731304	16-22	13	O	25	10	10,50
745731405	18-25	13	OX	25	10	10,50
745731506	22-30	13	1A	29	10	11,50
745731607	25-35	13	1	29	10	12,00
745731708	30-40	13	1X	29	10	12,00
745731809	32-45	13	1M	29	10	12,00



Order nr.	Capaciteit mm	Band- breedte mm	Doos nummer	Z maxi- mum mm	VE	Prijs/VE €
745731910	35-50	13	2A	33	10	13,50
745732011	40-55	13	2	33	10	13,50
745732112	45-60	13	2X	33	10	14,50
745732213	55-70	13	3	33	10	15,50
745732314	60-80	13	3X	33	1	1,70
745732415	70-90	13	4	33	1	1,69
745732516	85-100	13	4X	33	1	1,92
745732617	90-120	13	5	33	1	1,99
745732718	110-140	13	6	33	1	2,25
745732819	130-150	13	6X	33	1	2,37
745732920	135-165	13	7	33	1	2,35
745733021	158-190	13	7,5	33	1	2,99
745733122	184-216	13	8,5	33	1	3,38
745733223	210-242	13	9,5	33	1	3,61
745733324	235-267	13	10,5	33	1	3,93
745733425	260-292	13	11,5	33	1	4,27
745733526	286-318	13	12,5	33	1	4,50



Roestvrijstalen slangklemmen. Light versie. RVS staal type 316. BS1449PT.2 DIN 14401 A4 Breedte 9,9 mm. VE = verpakkingseenheid.

Order nr.	Capaciteit mm	Band- breedte mm	Band- dikte mm	Z maxi- mum mm	VE	Prijs/ VE €
745671304	14 - 22	9,9	0,76	24	20	52,90
745671405	16 - 25	9,9	0,76	24	20	52,90
745671506	22 - 30	9,9	0,76	24	20	56,90
745671607	20 - 32	9,9	0,76	24	20	57,90
745671708	25 - 35	9,9	0,76	28	20	58,90
745671809	30 - 40	9,9	0,76	28	20	59,90
745671910	35 - 45	9,9	0,76	28	20	63,90
745672011	35 - 50	9,9	0,76	28	20	67,90
745672112	40 - 55	9,9	0,76	33	20	70,90
745672213	45 - 60	9,9	0,76	33	20	73,50
745672314	55 - 70	9,9	0,76	33	20	79,90
745672415	60 - 80	9,9	0,76	33	1	4,27
745672516	70 - 90	9,9	0,76	33	1	4,50
745672617	80 - 100	9,9	0,76	33	1	4,60
745672718	90 - 110	9,9	0,76	33	1	4,85
745672819	100 - 120	9,9	0,76	33	1	5,30
745672920	110 - 130	9,9	0,76	33	1	5,40
745673021	120 - 140	9,9	0,76	33	1	5,60
745673223	140 - 160	9,9	0,76	33	1	6,20



Roestvrijstalen slangklemmen. Standaard versie. RVS staal. Type 316. BS1449PT.2 DIN 14401 A4. Breedte 13 mm. VE = verpakkingseenheid.

Order nr.	Capaciteit mm	Band- breedte mm	Doos nummer	Z maxi- mum mm	VE	Prijs/VE €
745721001	9,5-12	9	OOO	21	10	25,90
745721102	11-16	9	MOO	21	10	25,90
745721203	13-20	9	OO	21	10	26,50
745721304	16-22	13	O	25	10	30,90
745721405	18-25	13	OX	25	10	30,90
745721506	22-30	13	1A	29	10	31,50
745721607	25-35	13	1	29	10	35,00
745721708	30-40	13	1X	29	10	35,00
745721809	32-45	13	1M	29	10	37,50
745721910	35-50	13	2A	33	10	39,90
745722011	40-55	13	2	33	10	41,50
745722112	45-60	13	2X	33	10	43,50
745722213	55-70	13	3	33	10	46,90
745722314	60-80	13	3X	33	1	4,95
745722415	70-90	13	4	33	1	5,30
745722516	85-100	13	4X	33	1	5,40
745722617	90-120	13	5	33	1	6,10
745723021	158-190	13	7,5	33	1	8,20
745723223	210-242	13	9,5	33	1	10,50
745723526	286-318	13	12,5	33	1	12,90

Slangklemmen



RVS

Hight Torque slangklemmen. Roestvrijstalen uitvoering. Aanspankoppel is 2x groter dan bij de normale slangklem. Voor de zeer veeleisende industriële toepassing. Geleverd per stuk.

Order nr.	Capaciteit mm	Prijs €
745742035	20-35	8,70
745742540	25-40	8,90
745743050	30-50	9,00
745744070	40-70	9,50
745746080	60-80	9,80
745747095	70-95	10,50
745740100	80-100	10,50
745740120	90-120	10,90
745740140	110-140	11,50
745740160	130-160	11,90
745740180	150-180	12,50
745740200	170-200	13,50
745740220	190-220	13,50
745740240	210-240	14,50
745740260	230-260	14,50
745740280	250-280	17,50
745740300	270-300	17,50
745740320	290-320	18,50
745740340	310-340	16,90
745740360	330-360	17,50
745740380	350-380	17,90
745740460	430-460	20,50
745740480	450-480	20,50
745740500	470-500	21,00



VERZINKT STAAL

Super-slangklem extra-zware uitvoering. Staalverzinkte stalen uitvoering (ook leverbaar in roestvrijstalen uitvoering op aanvraag). Geleverd per stuk.

Order nr.	Capaciteit mm	Band-breedte mm	Band-dikte mm	Aan-bevolen torsie Nm	Schroef mm	Prijs €
745661720	17-19	18	0.60	6	8	2,14
745662325	23-25	18	0.60	6	8	2,25
745662931	29-31	18	0.60	6	8	2,37
745663639	36-39	18	0.60	6	8	2,71
745664043	40-43	18	0.60	6	8	3,27
745664447	44-47	20	1.00	8	10	3,38
745664851	48-51	20	1.00	8	10	3,38
745665255	52-55	20	1.00	8	10	3,49
745665659	56-59	20	1.00	8	10	3,61
745666467	64-67	20	1.00	8	10	4,50
745666873	68-73	20	1.00	8	10	4,50
745667479	74-79	20	1.00	8	10	5,20
745668085	80-85	20	1.00	8	10	5,20
745669297	92-97	25	1.50	25	13	5,40
745660103	98-103	25	1.50	25	13	5,50
745660112	104-112	25	1.50	25	13	5,60
745660130	122-130	25	1.50	25	13	5,90
745660139	131-139	25	1.50	25	13	6,10
745660148	140-148	25	1.50	25	13	6,10
745660161	149-161	25	1.50	25	13	6,50
745660174	162-174	25	1.50	25	13	6,90



VERZINKT STAAL

Wingspade slangklem met kunststof vleugelmoer. Band, schroef en huis in verzinkt staal. VE = verpakkingseenheid.

Order nr.	Capaciteit mm	VE	Prijs/VE €
745600812	8-12	20	32,50
745601017	10-16	20	33,00
745601220	12-20	20	33,00
745601625	16-25	20	29,90
745602032	20-32	20	33,50
745602540	25-40	20	35,50
745603250	32-50	20	35,50
745604060	40-60	20	38,50
745605070	50-70	20	42,50



VERZINKT STAAL

Junior slangklemmen. Staalverzinkte uitvoering. 9mm brede band. Band BS1449CS. Schroef 7mm. Geschikt voor bvb kleine brandstofleidingen ed. Max. kracht 1,2Nm. VE = verpakkingseenheid.

Order nr.	Capaciteit mm	VE	Prijs/VE €
745691001	7-9	50	32,50
745691102	8-10	50	32,50
745691203	9-11	50	32,50
745691304	10-12	50	32,50
745691405	11-13	50	32,50
745691506	12-14	50	32,50
745691607	13-15	50	32,50
745691708	14-16	50	35,00
745691809	15-17	50	35,00
745691910	16-18	50	35,00



VERZINKT STAAL

2-Oors-slangklemmen. Staalverzinkte uitvoering. Voor slangbevestigingen in lage en middeldruk. VE = verpakkingseenheid.

Order nr.	Capaciteit mm	VE	Prijs/VE €
745701304	5,0-7,0	50	22,50
745701405	7,0-9,0	50	25,00
745701506	8,0-11,0	50	25,00
745701607	9,0-11,0	50	27,50
745701708	11,0-13,0	50	27,50
745701809	13,0-15,0	50	29,90
745701910	15,0-17,0	50	29,90
745702011	15,0-18,0	50	32,50
745702112	16,0-19,0	50	35,00
745702213	17,0-20,0	50	35,00
745702314	19,0-22,0	50	47,50
745702415	20,0-23,0	50	47,50
745702516	22,0-25,0	25	26,50
745702617	23,0-27,0	25	27,50
745702718	25,0-28,0	25	27,50
745702819	27,0-31,0	25	29,90
745702920	28,0-31,0	25	29,90
745703021	31,0-34,0	25	31,50
745703122	34,0-37,0	25	32,50
745703324	40,0-43,0	25	35,00
745703425	43,0-46,0	25	36,50



NEW

VERZINKT STAAL

Multi-band. Maak uw eigen slangklem op de gewenste lengte met de multi-band. Assortiment met een slangklemmenband met schroeven en dito schroefhuls. Slangklemmenband is in verzinkte en stalen uitvoering - breedte 11 mm.

Order nr.	Aantal schroeven	Lengte m	Prijs €
745651100	25	10	90,50
745747104	100	-	104,00
745747102	0	10	41,50
745747103	0	30	102,00



NEW

RVS

Multi-band. Maak uw eigen slangklem op de gewenste lengte met de multi-band. Assortiment met een slangklemmenband met schroeven en dito schroefhuls. Slangklemmenband is in RVS - breedte 11 mm.

Order nr.	745747101	745651102	745651101
Aantal schroeven	25	100	0
Lengte m	10	-	30
Prijs €	114,00	187,00	164,00



VERZINKT STAAL

100-delige display van standaard staalverzinkte slangklemmen bestaande uit 10 x 10 verschillende maten.

Order nr.	745661000
Aantal stuks	100
Bevat	10 stuks elks 9.5-12 / 11-16 / 13-20 / 16-22 / 18-25 / 22-30 / 25-35 / 30-40 / 35-50 / 40-55mm
Prijs €	92,50



Schroevendraaier voor slangklemmen. Snelle en gemakkelijke instelling van de Jubilee klemringen dank zij onze Flexidriver.

De Jubilee Flexidriver is een hoge kwaliteitsproduct met een 7mm A/F doppenkop geschikt voor Jubilee klemringen en zijn flexibele schacht vergemakkelijkt het werk in ontoegankelijke hoekjes.

Order nr.	745661010
Aantal stuks	2
Bevat	Jubilee flexdriver
Aansluiting	mm 7
Lengte	mm 280
Prijs €	18,50

TENGOOLS



Schroevendraaier voor slangklemmen. Met flexibele schacht voor een goede toegankelijkheid. Met omwisselbare dop van 6 en 7mm. Totale lengte 260mm.

Order nr.	68180108
Prijs €	13,90

TENGOOLS

Bi-ervangdop 6 en 7mm voor MD503.

Order nr.	61180207
Prijs €	1,70

TENGOOLS



Schroevendraaier voor slangklemmen met flexibel schat. Geschikt voor 7mm slangklemmen. Totale lengte van 270mm.

Order nr.	117720102
Prijs €	10,50



NEW

Jubilee tang voor oors-slangklemmen. Normale sluiting (JUCLP) of zijsluiting (JUCLPS), voor moeilijk bereikbare klemmen.

Order nr.	745661030	745747107
Orig. nr.	JUCLP	JUCLPS
Prijs €	45,50	45,50

Werklampen

METALWORKS

EQUIPMENT



Werklamp koudlicht Profi Work op S-voet (ZBLK436SF) of op hoge voet (ZBLK436HF).

Energiebesparend werklucht op lage S-voet. De 4x36W fluorescentielampen bieden een lichtsterkte van 11000 Lumen, vergelijkbaar met een halogeenlamp van 500W. Schokbestendige rubber behuizing. Geschikt voor gebruik op werven en buitengebruik. Met elektronische ballast. IP 54.

Voorzien van 3 veiligheidsstopcontacten 2P+T 230V/15A op de achterkant. (max. 3500W-16A) en on/off schakelaar. Stevige neopreen aansluitkabel L.5m (H07RN-F 3G1.5) met veiligheidsstekker.

Koudlicht-werklampen bieden tal van voordelen tegenover klassieke halogeenlampen: Ze verbruiken tot 4x minder energie. Het witte licht is tot 4x helderder en aangener om in te werken. De levensduur van de lampen is tot 10x langer. Tot 10x lagere temperatuur: veiliger.

Order nr.	105270660	105270661
Orig. nr.	ZBLK436SF	ZBLK436HF
Capaciteit	W 4x36	4x36
Capaciteit	lumen 11000	11000
Lichttemperatuur	K 4100	4100
Prijs	€ 99,90	135,00

METALWORKS



Hoge voet met adapters voor ZBLK436 SF fluorescentielamp.

Order nr.	105270663
Orig. nr.	ZBLK436A
Prijs	€ 39,50

METALWORKS



Adapter voor muurmontage van fluoresciëntielamp ZBLK436SF.

Order nr.	105270664
Orig. nr.	ZBLK436A2
Prijs	€ 8,20

VC



TL Lampen 12-24W voor voertuigen. Plafondlicht met neonlamp voor perfecte verlichting van de laadruimte. Uitergest met schakelaar en beschermkap uit stevig polycarbonaat. Dit is een krachtige lamp die het licht voldoende verspreidt en die toch weinig energie verbruikt. CE-gekeurd.

Order nr.	815611001	815611002
Orig. nr.	LPD	LPDP
Capaciteit	W 11	18
Lengte	mm 660	320
Spanning	V 12	12
Prijs	€ 111,00	110,00

LED handlampen

TENGTOOLS



LED-looplamp met pocket-clip. Voorzien van 3 hoogkwalitatieve LED-diodes. Handig zakmodel lamp. 2 x AAA batterij niet geleverd.

Order nr.	144330107	
Orig. nr.	584	
Lengte	mm	130
Prijs	€	21,00

TENGTOOLS



Zwarte LED zaklamp Cree. Met extra lange duur. Batterij niet meegeleverd.

Order nr.	172310104	172310203	172310302
Orig. nr.	581	582	583
Lengte	mm	107	136
LED wattage	W	1	3
Batterijen	AA/2	AAA/3	C/2
Prijs	€	31,50	38,00

TENGTOOLS



LED-looplamp. Voorzien van 5 hoogwaardige LED-diodes. Met een antislip rubber handvat. Waterdichte uitvoering. 2 x AA batterij niet geleverd.

Order nr.	132390105	
Orig. nr.	585	
Prijs	€	21,00

TENGTOOLS



Flexibele LED lamp met magneet. Met 3 LEDs. 3 x LR44 niet meegeleverd.

Order nr.	167910108	
Orig. nr.	587M	
Lengte	mm	370
Diameter	mm	25
Prijs	€	13,90

TENGTOOLS



Werklamp op lang flexibel handvat. Voor mobiel gebruik in gesloten ruimte. Magnetisch. Te gebruiken met batterijen 2 x R6 (niet meegeleverd).

Order nr.	69060101	
Orig. nr.	586	
Lengte	mm	595
Lengte kabel	mm	400
Prijs	€	45,90



METALWORKS



NEW

LUMEN

100

MODE

Power saving

MODE

Alarm flashing



Krachtige 100 lumen hoofdlamp op 3xAAA batterijen (inbegrepen). 3 standen: witte en rode alarmverlichting. Incl. hoofdband.

Order nr.	801106030 €	
Orig. nr.	W	HL100
LED wattage	h	3
Levensduur	lumen	10000
Lichtsterkte	h	100
VE		1
Min. bestelhoeveelheid		10
Prijs/VE	€	8,90

METALWORKS



NEW

LUMEN

80+10



bevestigbaar met magneet en met clip



Super compacte en veelzijdige LED zaklamp. 80 lumen lichtopbrengst op zijkant en 10 lumen spot op bovenkant van de zaklamp. Geselecteerde SMD LEDS met lange autonomie. Grote lichthoek 120° (zijkant) en 40° bundel (bovenkant). Met 2 sterke magneten op rug en voet, en draagclips voor broekzak of riem. Werkt op 3xAAA standaard batterijen. Anti-slip rubberhandvat.

Verkocht per 16 stuks in een Metalworks display.

Order nr.	801106032 €	
Orig. nr.	W	WLP80
Levensduur	h	10000
Lichtsterkte	lumen	80+10
Autonomie	h	3
VE		1
Min. bestelhoeveelheid		16
Prijs/VE	€	9,90



auto oplader

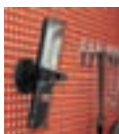

magnetische bevestigingsclip



(bevestigings) standaard

METALWORKS



LUMEN

250



Handlamp met superkrachtige COB LED 4W. Draadloos met heroplaadbare NiMH 1800MAH batterij. Met AC (230V) en DC (12V) oplader en LED laadindicator. Quasi onbreekbare polycarbonaat cover, geïntegreerde riemclip en multifunctionele haak. Handig en compact. Vekocht per 10 stuks in een Metalworks display.

Order nr.	801106010 €	
Orig. nr.	W	WLO010S
Lengte	mm	185
Kleurtemperatuur	K	8000
Lichtsterkte	lumen	250
Autonomie	h	2,5
Opladtid	h	4
VE		1
Min. bestelhoeveelheid		10
Prijs/VE	€	30,90

METALWORKS



(auto) oplader



bevestigingsclip



standaard



bevestigbaar met magneet



Super krachtige LED handlamp met herlaadbare batterijen. 600 lumen fel witte lichtbundel zorgt voor een royaal en ruim verlicht werkgebied in alle omstandigheden.

*Brede lichtbundel 120° die het ganse gezichtsveld bereikt.

*12 SMD LEDS gekenmerkt door lange levensduur (door lage opwarming).

*2 lichtstanden: 100% en 50% voor langere standtijd.

*Met herlaadbare li-ion battery 3.7V 2200mAh, oplaadbaar via AC (230V)- en DC- (12V) auto-oplader.

*Met krachtige rugmagneet en 360° draaibare, onbreekbare nylon haak bovenaan.

*Geleverd met extra lampsteun voor het rechtop zetten van de lamp

*Onbreekbare cover uit polycarbonaat.

*Anti-slip handvat.

Verkocht per 8 stuks in een Metalworks display.

Order nr.		801106060 €
Orig. nr.		WLT600
Levensduur	h	10000
Lichtsterkte	lumen	600-300
Autonomie	h	4-8
VE		1
Min. bestelhoeveelheid		8
Prijs/VE	€	37,90

METALWORKS



vaste stekker



bevestigbaar met magneet



Super krachtige LED looplamp met kabel. 400 lumen fel witte lichtopbrengst zorgt voor voldoende licht in alle omstandigheden. Brede lichtbundel 120° die het ganse gezichtsveld bereikt.

12 SMD LEDS gekenmerkt door lange levensduur door lage opwarming.

Met krachtige rugmagneet en 360° draaibare, onbreekbare nylon haak bovenaan. Werkt via 230V netroom met kabel H05RNF 3 meter. Onbreekbare cover uit polycarbonaat. Anti-slip handvat.

Verkocht per 8 stuks in een Metalworks display.

Order nr.		801106045 €
Orig. nr.		WLT400
Spanning	V	230
Lichtsterkte	lumen	400
Maximum lengte	mm	3000
Prijs	€	24,50

★ HEY! LOOK ★

e.g. chemical splashes. Even protection against radiation, for example UV radiation or bright lights, can be hazards that you may be subjected to over the course of a working day.

In order to be able to safely choose the right protection, it is important to determine what risks exist in the surrounding environment and that you are careful to ensure that the protection is tailored to the person using it.

Eye protection is worn in order to provide protection against risks directed towards the eyes and face. These risks can be partly mechanical, e.g. flying particles and partly chemical,



CHOOSING THE BEST FIT



In order for protective eyewear to protect in a safe manner it is important that they are fitted to the person wearing them. If the eyewear does not fit as designed, there is a risk of gaps occurring where dangerous particles or radiation can penetrate and damage the eye. We all have different shaped faces and there is no single eyewear product that fits all.

We have chosen to divide our eyewear into three categories - Small, Medium and Large to make the choice easier.

THIS CAN GIVE YOU GUIDANCE IN CHOOSING YOUR EYEWEAR, BUT IT IS STILL IMPORTANT TO TRY THE EYEWEAR TO ENSURE THEY SIT PROPERLY ON YOU.

There are many things that come into play, such as the width of the face and face shape which determine the optimal fit of the eyewear.

TYPE OF PROTECTION



GLASSES

Must have side protection. Some glasses can be used over prescription glasses. The lenses are made of impact resistant polycarbonate.



GOGGLES

Suitable where there is a risk of splashing from chemicals or in environments with a lot of particles.



VISORS

Protects both the eyes and face. Replaceable visors are available in different materials to suit different environments.



WELDING

Protects eyes and face from radiation when welding. There are also goggles that only protect your eyes, for example when brazing/cutting

AUTOMATIC DARKENING WELDING GLASS (AUTO/VARIABLE)

Protects the eyes and face. Darkens when the arc is struck. This allows you to work with both hands during the entire welding process, which increases quality and eliminates the risk of "welder's neck". The welding cassette and shield protect the welder from harmful UV and IR radiation. Recommended use of the different filter shades according to the table on www.zekler.com.

WELDING SHIELDS WITH COLOURED LENSES (FIXED)

Protects the eyes and face from radiation when welding. Also goggles that only protect your eyes, for example when brazing/cutting. Recommended use of the different filter shades according to the table on www.zekler.com.

FUNCTIONS



HC

SCRATCH RESISTANCE

A coating is applied to the lens to provide a strong scratch resistance, which prolongs the life of your eyewear.

HC/AF

SCRATCH/ANTIFOG RESISTANCE

A combined antifog and anti-scratch coating is applied to the lens. Prevents misting of the lens while providing good scratch resistance.

ADJUSTABLE LENS ANGLE

Allows you to adjust the lens angle against the face for an optimum fit.



ADJUSTABLE SIDEPIECE LENGTH

Allows you to change the sidearm length for maximum comfort and fit.

OVER GLASSES

Designed to fit over existing glasses. Protects your eyes and your regular glasses while maintaining visual acuity.

SOFT NOSE BRIDGE

Soft nose bridge for optimum user comfort.

LENS TYPES FOR PROTECTIVE EYEWEAR



CLEAR PC

Impact-resistant
For mechanical hazards
Useful in low light conditions
UV protection
Optical class 1
Lens marking 2-1.2 or 2C-1.2 SK 1F
Complies with
EN166 and EN170



BROWN PC

Impact-resistant
Sunscreen lens
Suitable for outdoor work
UV 400
Optical class 1
Lens marking 5-2.5 SK 1F
Complies with
EN166 and EN172



WELD FILTER PC

Impact-resistant
Shade 3
Shade 5
Suitable for gas welding, brazing
UV protection
Optical class 1
Lens marking 3 or 5 SK 1F
Complies with
EN166 and EN169



YELLOW PC

Impact-resistant
Contrast enhancement
Suitable for inspection work
UV protection
Optical class 1
Lens marking 2-1.2 SK 1F
Complies with
EN166 and EN170



GREY PC

SILVER MIRROR PC

BLUE MIRROR PC

Impact-resistant
Sunscreen lens
Suitable for outdoor work
UV 400
Optical class 1
Lens marking 5-2.5 or 5-3.1 SK 1F
Complies with
EN166 and EN172



BIFOCAL (READING GLASSES) PC

Impact-resistant
Protective eyewear/Reading glasses
Positive bifocal lens in strengths
+1.0/+1.5/+2.0/+2.5
Suitable for inspection of precision work, drawings, machining, instructions, etc. With Zekler's ground protective eyewear you will not have problems with double glasses while working.



ORANGE PC

Impact-resistant
Contrast enhancement
Experienced as restful to the eye
UV protection
Suitable for inspection work
Optical class 1
Lens marking 2-1.7 SK 1F
Complies with
EN166 and EN170



1/0 PC

Impact-resistant
Sunscreen lens (light gold mirror)
Suitable for varied work, indoors/outdoors
UV 400
Optical class 1
Lens marking 5-1.7 SK 1F
Complies with
EN166 and EN172

UV PROTECTION
>99.9% UV radiation up to
min. 385 nm

UV 400
100% UV radiation up to
min. 400 nm

Veiligheidsbrillen

ZEKLER



- Bezoekersbril.
 -heldere polycarbonaten glazen
 -UV bescherming
 -breed panorama lens met zijdelingse bescherming en ventilatie
 -kan gedragen worden met de meeste correctiebrillen
 -geschikt als bezoekersbril
 -EN166 klasse 1FT

Order nr.	380600338	€	2,80
Orig. nr.	ZE33C		
Kleur glazen	helder		
Prijs		€	2,80

ZEKLER



- Veiligheidsbril.
 -heldere, gele of grijze polycarbonaten glazen
 -anti-condens (380600304+380600312+380600320)
 -krasvast
 -UV bescherming
 -breed panorama lens met zijdelingse bescherming
 -geschikt als bezoekersbril
 -EN 166 klasse 1FT, EN 170 (380600312+380600510), EN 172 (380600320)

Order nr.	Orig. nr.	Kleur glazen	Anti-condens	Krasvast	Prijs €
380600304	ZE30C	helder	✓	✓	5,10
380600312	ZE30Y	geel	✓	✓	5,10
380600320	ZE30G	grijs	✓	✓	5,10
380600502	ZE30CHC	helder	x	✓	3,50
380600510	ZE30YHC	geel	x	✓	3,60

ZEKLER



- Veiligheidsbril.
 -heldere, gele, grijze of oranje polycarbonaten glazen
 -anti-condens (380600478+380600486)
 -krasvast
 -UV bescherming
 -zachte neusbrug
 -verstelbare veren
 -EN 166 klasse 1F, EN 170 (380600460) en EN 172 (380600478)
 -verscherpt het zicht voor contrasten (380600460+380600486)

Order nr.	Orig. nr.	Kleur glazen	Anti-condens	Krasvast	Prijs €
380600452	ZE45C	helder	x	✓	11,50
380600460	ZE45Y	geel	x	✓	11,50
380600478	ZE45G	grijs	✓	✓	13,50
380600486	ZE45O	oranje	✓	✓	13,50

ZEKLER



- Veiligheidsbril.
 -heldere, gele, grijze of groene polycarbonaten glazen
 -krasvast
 -UV bescherming (niet voor 380605097)
 -zachte neusbrug
 -verstelbare veren
 -aanpasbare lenshoek
 -EN 166 klasse 1F

Order nr.	Orig. nr.	Kleur glazen	Krasvast	Prijs €
380600551	ZE55C	helder	✓	9,80
380600569	ZE55Y	geel	✓	10,50
380600577	ZE55G	grijs	✓	10,50
380605097	ZE55GR	groen	✓	19,00

ZEKLER



Veiligheidsbril.
-heldere polycarbonaat glazen
-anti-condens
-zijdelingse bescherming
-UV bescherming
-krasvast
-speciaal aangepast voor smallere hoofd vormen
-EN166 klasse 1FH en EN 170

Order nr.	380650200
Orig. nr.	ZE235C
Kleur glazen	helder
Anti-condens	✓
Krasvast	✓
Prijs	€ 5,20

ZEKLER



Veiligheid- en leesbril.
-heldere polycarbonaten glazen
-UV bescherming
-krasvast
-verstelbare veren
-aanpasbare lenshoek
-zachte neusbrug
-Bifocale glazen
-EN 166 klasse 1F en EN 170

Order nr.	Orig. nr.	Correctie	Prijs €
380605105	ZE55B1	+ 1.0	15,90
380605154	ZE55B1.5	+ 1.5	15,90
380605204	ZE55B2	+ 2.0	15,90
380605253	ZE55B2.5	+ 2.5	15,90

ZEKLER



Veiligheidsbril met zonnebescherming.
-polycarbonaten, krasvaste en anti-condens glazen
-UV bescherming
-zachte neusbrug
-zacht, soepel veereinde

Order nr.	380670018	380670026
Orig. nr.	Z101G	Z101MR
Kleur montuur	grijs zebra	metaal rood
Kleur glazen	grijs	grijs
Anti-condens	✓	✓
Krasvast	✓	✓
Prijs	€ 14,90	14,90

ZEKLER



Veiligheidsbril met zonnebescherming.

- Polycarbonaten, krasvaste en anti-condens glazen
- UV bescherming (UV 400)
- Zachte neusbrug
- Zacht, soepel veereinde
- Grijs glazen
- EN 166, klasse 1 F, EN 172

Order nr.	380670091
Prijs	€ 14,50

ZEKLER



Veiligheidsbril met zonnebescherming.
-polycarbonaten, krasvaste en anti-condens glazen
-UV bescherming

Order nr.	380670141
Orig. nr.	ZE106GY
Kleur montuur	zwart
Kleur glazen	grijs
Anti-condens	✓
Krasvast	✓
Prijs	€ 14,90

ZEKLER



Overzetbril.
 -heldere polycarbonaat
 -anti-condens & antikras
 -gesloten, goed aansluitend design
 -6 afgedekte openingen voor ventilatie
 -regelbare hoofdband
 -kan gedragen worden met de meeste correctiebrillen
 -Beschermt tegen vloeistoffen (3) en grote stofdelen (4)
 -EN 166, klasse 1B

Order nr.	380600445
Orig. nr.	ZE44IMF
Kleur glazen	helder
Anti-condens	✓
Prijs	€ 5,80

ZEKLER



Overzetbril.
 -heldere polycarbonaat
 -anti-condens
 -gesloten, goed aansluitend design
 -2 afgedekte openingen voor ventilatie
 -regelbare hoofdband
 -kan gedragen worden met de meeste correctiebrillen
 -beschermt tegen vloeistoffen (3) en grote stofdelen (4)
 -EN 166, klasse 1B

Order nr.	380600882
Orig. nr.	ZE88IMF
Kleur glazen	helder
Anti-condens	✓
Prijs	€ 10,50

ZEKLER



Overzetbril.
 -heldere of gele polycarbonaat glazen
 -anti-condens
 -krasvast
 -UV bescherming
 -zijdelings verstelbaar
 -aanpasbare lenshoek
 -kan gedragen worden met de meeste correctiebrillen
 -EN 166 klasse 1F en EN 170 (3806900221)

Order nr.	380600213	380600221
Orig. nr.	ZE25C	ZE25Y
Kleur glazen	helder	geel
Anti-condens	✓	✓
Krasvast	✓	✓
Prijs	€ 8,70	8,70

ZEKLER



Overzetbril.
 -anti-kras en anti-condens acetaat lens
 -flexibele PVC die goed aansluit bij de gelaatsvorm
 -regelbare ventilatie
 -compatibel met andere PBM
 -verstelbare hoofdband
 -EN 166

Order nr.	380600916
Orig. nr.	ZE90
Kleur glazen	helder
Anti-condens	✓
Krasvast	✓
Prijs	€ 17,00

ZEKLER



Vervanglens voor ZE90.

Order nr.	380600924	380600932
Orig. nr.	ZEL90PC	ZEL90AC
Kleur glazen	polycarbonaat	acetaat
Anti-condens	✓	✓
Krasvast	✓	✓
Prijs	€ 5,90	9,90

ZEKLER



Overzetbril Zekler 95 HC/AF.

- Heldere polycarbonaat
- Anti-condens & anti-kras
- Gesloten, goed aansluitend design
- Regelbare hoofdband
- Geventileerd
- Beschermt tegen vloeistoffen (3) en grote stofdelen (4).
- EN 166, klasse 1B T34 en EN170

Order nr.		380600940
Prijs	€	17,50

ZEKLER



Opbergglas voor ZEKLER veiligheidsbrillen.

Order nr.	380600403	380600783
Orig. nr.	ZEACMV	ZEACCH
Omschrijving	in microvezels	hard
Prijs	€ 2,30	4,20

ZEKLER



Opbergglas voor ZEKLER veiligheidsbrillen met riemhouder.

Order nr.	380600767
Orig. nr.	ZEACCHR
Prijs	€ 10,50

ZEKLER



Zachte opbergglas voor ZEKLER veiligheidsbrillen.

Order nr.	380600775
Orig. nr.	ZEACCK
Prijs	€ 5,70

ZEKLER



Brilkenoord voor ZEKLER veiligheidsbrillen.

Order nr.	380600791	380600809
Orig. nr.	ZEACCK	ZEACCK2
Prijs	€ 2,80	1,10

Gezichtschermen

ZEKLER



Gezichts scherm.

- polycarbonaat
- met hoofd en voorhoofd bescherming in impact bestendig polycarbonaat
- regelbare hoofdband
- scherm rondom versterkt met een metaalband
- het scherm kan opgetrokken worden
- een stoffen band neemt het zweet op en geeft een maximum aan comfort
- EN 166, klasse 1B

Order nr.	380601005
Orig. nr.	ZE10
Kleur glazen	helder
Prijs	€ 20,90

ZEKLER



Vervangscherm voor ZEKLER 10.

Order nr.	380601013
Orig. nr.	ZE10PC
Kleur glazen	helder
Prijs	€ 9,70

METALWORKS



NEW

Beschermkap voor zandstralen.

Order nr.	754750020
Orig. nr.	CATSBH
Gewicht	kg 5,00
Afmetingen (l x b x h)	mm 470 x 300 x 560
Prijs	€ 20,50

Lashelmen



Automatische lashelm voor elektrodelassen MIG en slijpen. Groot zichtvenster. Effectieve en handenvrije bescherming van ogen en hals tegen straling en vonken. Instelling van gevoeligheid (DIN-waarde). Werkt volautomatisch op zonnecellen. Getest volgens normen EN379 en EN175. Met testfunctie.

Model XL-W is uiterst licht en heeft 3 terugschakeltijden. Voorzien van een hoofdband met dubbel scharnier voor optimale reksteun.

Order nr.	711654001
Orig. nr.	1654001
Toepassing	Elekt./MIG/Slijpen
Zichtvenster	98x55
Stroom	zonnecellen + batterij
Aan/uit	volautomatisch
DIN waarde	DIN 9 tot 13
Omschakel reactietijd (helder naar donker)	s 1/30000
Omschakel reactietijd (donker naar helder)	s 0,25-0,8
Slijpfunctie	✓
Testfunctie	✓
Sensoren	2
Prijs	€ 79,00



Automatische lashelm voor elektrodelassen MIG, TIG (XL-W) en slijpen. Groot zichtvenster. Effectieve en handenvrije bescherming van ogen en hals tegen straling en vonken. Instelling van gevoeligheid (DIN-waarde). Werkt volautomatisch op zonnecellen. Getest volgens normen EN379 en EN175. Met testfunctie.

Model XL-W is uiterst licht en heeft 3 terugschakeltijden. Voorzien van een hoofdband met dubbel scharnier voor optimale reksteun.

Order nr.	711654005
Orig. nr.	1654005
Toepassing	Elekt./MIG/TIG
Zichtvenster	mm 98x55
Stroom	zonnecellen + batterij
Aan/uit	volautomatisch
DIN waarde	DIN 9 tot 13
Omschakel reactietijd (helder naar donker)	s 1/30000
Omschakel reactietijd (donker naar helder)	s 0,25-0,4-0,8
Slijpfunctie	✓
Testfunctie	✓
TIG	✓
Sensoren	4
Prijs	€ 95,00

AUTOMATIC

METALWORKS



Automatische lashelm voor MIG en MMA.

- Complete bescherming van ogen en hals tegen straling en vonken tijdens het lassen.
- Kijkvenster van 90x35mm.
- Onbreekbare en buigzame nylon kap.
- Hoge filterklasse 1/1 / 1/2 van de cassette garandeert minimale schadelijke instraling en een maximale helderheid van het zichtvenster.
- 1 regeling op de buitenkant van de kap: DIN 9-13.
- Comfortabele hoofdband.
- Energiebron: zonnecellen + vervangbare knooppellen. Batterij met levensduur tot 5000h.
- 2 sensoren voor detectie van vlamboog.

Order nr.	829000015 E	
Orig. nr.	PROTECT413	
Zichtvenster	mm	90x35
Stroom	zonne-energie en batterij	
DIN waarde	DIN	9 tot 13 (traploos)
Optische klasse	1/1/1/2	
Werkbereik	A	15
Omschakeltijd	ms	0,5
Vertraging	s	0,1 - 0,7 (auto)
Ultraviolet bescherming	%	0,0003 (313nm)
Infrarood bescherming	%	0,01 (780-2000nm)
Gebruikstemperatuur	°C	-10 - 60
Sensoren	2	
Bescherming	DIN	15
Gewicht	kg	0,49
Prijs	€	41,50

METALWORKS



NEW
AUTOMATIC
TIG + SLIJEN

Automatische lashelm voor alle lasprocedures (MIG, MMA, TIG) alsook plasmasnijden, autogeen lassen, puntlassen en slijpen.

- Laat toe te lassen in lage stroomsterkte, vanaf 5A.
- Complete bescherming van ogen en hals tegen straling en vonken tijdens het lassen.
- Zeer groot kijkvenster van 98x55mm voor een perfect zicht op de werkomgeving.
- Onbreekbare en buigzame nylon kap.
- Hoge filterklasse 1/2/1/2 van de cassette garandeert minimale schadelijke instraling en een maximale helderheid van het zichtvenster.
- 4 regelingen op de buitenkant van de kap: DIN-waarde 9-13, gevoeligheid, keuzestand lassen/slijpen en vertraging.
- Ideaal om tijdens het lassen snel bij te regelen, zelfs met lashandschoenen aan.
- Testknop binnenin de lashelm garandeert de veiligheid van de gebruiker.
- Comfortabele hoofdband met dubbele scharnieren, met diverse instelmogelijkheden voor een optimale ergonomie.
- Energiebron: zonnecellen + vervangbare knooppellen. Batterij met levensduur tot 5000h.
- 4 sensoren voor detectie van vlamboog.
- Gelanzende gelakte afwerking voor gemakkelijk reinigen
- Geleverd met 2 x reserve buitenspatruut en 1 x binnenspatruut

Order nr.	829000020 E	
Orig. nr.	PROTECT550	
Zichtvenster	mm	98x55
Stroom	zonne-energie en batterij	
DIN waarde	DIN	9-13 (traploos)
Optische klasse	1/2/1/2	
Werkbereik	A	5
Slijpfunctie	✓	
Batterijalarm	✓	
Testfunctie	✓	
TIG	✓	
Omschakeltijd	ms	0,04
Vertraging	s	0,15-0,8
Ultraviolet bescherming	%	0,0003 (313nm)
Infrarood bescherming	%	0,01 (780-2000nm)
Gebruikstemperatuur	°C	-5 - 55
Sensoren	4	
Bescherming	DIN	16
Gewicht	kg	0,49
Prijs	€	69,00



Accessoires voor lashelmen.

Order nr.	Orig. nr.	Omschrijving	Voor type	Afmetingen	VE	Min. bestelhoeveelheid	Prijs/VE
				mm			€
830445650	445650	donker glas DIN 11	AX400FU	110x60	1	1	7,00
830445660	445660	binnenspatruit	AX400FU	110x52	1	1	20,00
830445530	1660115	binnenspatruit	AX400V	47x97	10	1	30,00
711662003	1662003	binnenspatruit	Varioprotect L/XL	107x58	10	1	13,00
830445507	1660112	buitenspatruit	protect - AX400V	90x110	10	1	18,00
830445640	445640	buitenspatruit	AX400FU	110x60	1	1	50,00
711662001	1662001	buitenspatruit	Varioprotect L/XL	114x89	10	1	16,00
711662005	1662005	zweetband	Varioprotect L/XL		1	1	2,00
830445540	1660007	zweetband	Vario-protect - AX400V		10	1	5,40
711660118	1660118	instelband	Varioprotect L/XL		1	1	13,00
711662007	1662007	vervangbatterij	Varioprotect L/XL		1	1	2,00
711662021	1662021	Binnenspatruit	Varioprotect XL-W		10	1	13,00
891567290	1662020	Buitenspatruit	Varioprotect XL-W		10	1	16,00
829000011	PRO-TECT311-B	buitenspatruit	PRO-TECT311		1	10	1,80
829000016	PRO-TECT413-BU	buitenspatruit	PRO-TECT413		1	1	1,80
829000017	PRO-TECT413-BI	buitenspatruit	PRO-TECT413		1	1	1,60



Omhoogklapbare beschermbril voor snijbranders en autogeen lassen. Zacht en stabiel PVC. Ook geschikt voor bril dragers. Omhoogklapbare DIN-glazen, daaronder kleurloze glazen. DIN glazen met een doormeter van 50mm. Volgens EN 166 3 4 F 0196 CE.

Order nr.	711600305
Orig. nr.	1600305
Prijs	€ 16,50



Vervangglazen voor omhoogklapbare beschermbril 711600305. Minimum bestelhoeveelheid = 10 stuks.

Order nr.	711600800	711600805
Orig. nr.	1600800	1600805
Omschrijving	Doorzichtige glazen 50 mm	DIN-glazen (gekleurd) 50 mm
VE	1	1
Min. bestelhoeveelheid	10	10
Prijs/VE	€ 2,10	1,20



Laskap handmodel. Economy uitvoering. Geleverd met donker glas 802575.

Order nr.	830802545
Orig. nr.	802545
Prijs	€ 16,00



Vervangglazen DIN10-11.

Order nr.	Orig. nr.	Omschrijving	Voor type	Prijs
				€
830802547	802547	donker glas 75x98 mm DIN11	-	5,50
830802548	802548	Transparant glas 75x98 mm (2st.)	-	4,80
830802575	802575	Donker glas 51x107mm DIN11	830802545	5,00
830802580	802580	Transparant glas 90x110 mm (2st)	830802546	6,00
830802581	802581	Donker glas 90x110 mm DIN10	830802546	6,00

Mutsen



Muts. 100% acrylic.

Order nr.	207912494	207912502
Orig. nr.	LBH563B	LBH563R
Kleur	zwart	rood
Prijs	€ 6,70	6,70



Lasmuts. 100% katoen.
Minimum besteleenheid = 10 stuks.

Order nr.	800012825
Orig. nr.	LBH580B
VE	1
Min. bestelhoeveelheid	10
Prijs/VE	€ 1,70

Ademhalingsbescherming



Hygiënemasker.
VE = verpakkingseenheid.

Order nr.	850001001
Orig. nr.	JOPMA10
Verpakking	carded
VE	10
Prijs/VE	€ 4,00



FIJNSTOFMASKER FFP1.
-conform CE 0086 EN149:2001
-bevestiging : elastiek
-regelbare neusclip : aan de binnenkant
-bescherming tegen calciumcarbonaat-magnesium-cement-zacht hout
-minimale bescherming tegen onschadelijke vaste-en vloeistofdeeltjes tot 10mg/m3 en tot 4X MDW
VE = verpakkingseenheid.

Order nr.	850001003	850001004
Orig. nr.	JOFMP12	JOFMP120
Verpakking	carded	doos
VE	3	20
Prijs/VE	€ 6,60	29,50



FIJNSTOFMASKER FFP1 MET VENTIEL.
-conform CE 0086 EN149:2001
-bevestiging : elastiek
-regelbare neusclip : aan de binnenkant
-met uitademingventiel
-bescherming in een vochtige omgeving tegen calciumcarbonaat-magnesium-cement-zacht hout
-minimale bescherming tegen onschadelijke vaste-en vloeistofdeeltjes tot 10mg/m3 en tot 4X MDW
VE = verpakkingseenheid.

Order nr.	850001005	850001006
Orig. nr.	JOFMP1V3	JOFMP1V15
Verpakking	carded	doos
VE	3	15
Prijs/VE	€ 8,80	35,00



FIJNSTOFMASKER FFP2 MET VENTIEL.
-conform CE 0086 EN149:2001
-bevestiging : elastiek
-regelbare neusclip : aan de binnenkant
-met uitademingventiel
-bescherming tegen schadelijke stoffen in een vochtige omgeving : glasfiber-kwarts-hardhout-zware metalen
-minimale bescherming tegen schadelijke vaste-en vloeistofdeeltjes tussen 0,1 en 10mg/m3 en tot 10X MDW
VE = verpakkingseenheid.

Order nr.	850001010
Orig. nr.	JOFMP2V1
Verpakking	doos
VE	15
Prijs/VE	€ 42,50



FIJNSTOFMASKER FFP3 MET VENTIEL.
-conform CE 0086 EN149:2001
-bevestiging : elastiek
-regelbare neusclip : aan de binnenkant
-met uitademingventiel
-bescherming tegen giftige stoffen : asbestfiber-zware metalen als nickel, chroom, lood-farmaceutische produkten
-minimale bescherming tegen schadelijke vaste-en vloeistofdeeltjes minder dan 0,1 mg/m3 en tot 30X MDW
VE = verpakkingseenheid.

Order nr.	850001011	850001012
Orig. nr.	JOFMP3V	JOFMP3V1
Verpakking	carded	doos
VE	3	10
Prijs/VE	€ 18,50	51,50

3M



VERFSPUITMASKER. Licht wegwerpmasker voor verf- en laksputwerkzaamheden, bij gebruik van lijmen en verdunningsmiddelen.

- conform CE EN405:2002
- onderhoudsvrij ontwerp voor maximale veiligheid en eenvoud
- 2 grote actiefkoolfilters zorgen voor een lage ademweerstand
- ergonomisch ontwerp voor goed zicht
- uitademventiel met lage weerstand, voorkomt warmteopbouw
- zacht en hypoallergeen materiaal
- lichtgewicht en goed gebalanceerd ontwerp
- instelbare hoofdband
- nekband met snelsluiting
- p2 filter
- bescherming tegen organische dampen (kookpunt boven 65°C) tot 50 keer (3M aanbeveling 10) de MAC/Belgische Grenswaarde of 1000ppm (de laagste waarde geldt) en tegen stofdeeltjes tot 50 keer de MAC/Belgische Grenswaarde.

MAC = maximaal aanvaarde concentratie.

Order nr.	388200990
Orig. nr.	3MFFA1P2D
Prijs	€ 54,50

3M



VERFSPUITMASKER. Licht wegwerpmasker voor verf- en laksputwerkzaamheden, bij gebruik van lijmen en verdunningsmiddelen.

- conform CE EN405:2002
- onderhoudsvrij ontwerp voor maximale veiligheid en eenvoud
- 2 grote actiefkoolfilters zorgen voor een lage ademweerstand
- ergonomisch ontwerp voor goed zicht
- uitademventiel met lage weerstand, voorkomt warmteopbouw
- zacht en hypoallergeen materiaal
- lichtgewicht en goed gebalanceerd ontwerp
- instelbare hoofdband
- nekband met snelsluiting
- p3 filter
- bescherming tegen organische dampen (kookpunt boven 65°C) tot 50 keer (3M aanbeveling 10) de MAC/Belgische Grenswaarde of 5000ppm (de laagste waarde geldt) en tegen stofdeeltjes tot 50 keer de MAC/Belgische Grenswaarde.

MAC = maximaal aanvaarde concentratie.

Order nr.	388231003
Orig. nr.	3MFFA2P3
Prijs	€ 65,50

Gehoorbescherming

METALWORK



Rode oorkap met abs cup.

- conform CE EN352-1
- zachte oorkussentjes in synthetisch leder voor een langdurig draagcomfort
- verstelbare hoofdband in 3 verschillende standen
- demping : 27db (SNR)

Order nr.	850001501
Orig. nr.	JOK27DB
Demping	dB (SNR) 27
Prijs	€ 6,40

METALWORK



Gele vouwbare oorkap met extra hoge demping.

- conform CE EN352-1
- zachte oorkussentjes in synthetisch leder voor een langdurig draagcomfort
- verstelbare hoofdband met een zachte binnenbekleding
- demping : 30db (SNR)

Order nr.	850001502
Orig. nr.	JOK30DB
Demping	dB (SNR) 30
Prijs	€ 11,50

ZEKLER



Comfortabele oorkap. Verstelbare hoofdband, met wisselbare bekleding

- conform EN 352-1
- brede, gemakkelijk wisselbare oorkussentjes

Order nr.	380682062	380682096	380682120
Orig. nr.	ZE401	ZE402	ZE403
Demping	dB (SNR) 26	30	33
Beschermingsniveau	1	2	3
Prijs	€ 15,90	20,50	22,50



Comfortabele oorkap met nekband. Verstelbare hoofdband met wisselbare bekleding en brede oorkussentjes.
-conform EN 352-1
-brede, gemakkelijk wisselbare oorkussentjes

Order nr.	380682088	380682112
Orig. nr.	ZE401N	ZE402N
Demping dB (SNR)	26	30
Beschermingsniveau	1	2
Prijs	€ 17,50	21,90



Comfortabele oorkap voor helm. Verstelbare hoofdband met wisselbare bekleding en brede oorkussentjes.
-conform EN 352-1
-brede, gemakkelijk wisselbare oorkussentjes
Helm niet inbegrepen.

Order nr.	380682070	380682104	380682138
Orig. nr.	ZE401H	ZE402H	ZE403H
Demping dB (SNR)	25	29	31
Beschermingsniveau	1	2	3
Prijs	€ 20,50	24,50	28,50



Oorkap met ingebouwde stereo FM radio. Aansluiting voor MP3. Goede bescherming (niveau 2) tegen lage en hoge frequenties. De verstelbare hoofdband en de brede oorkussentjes zorgen voor een uitgebalanceerd gewicht en een groot comfort.
-conform EN 352-1, 352-6, 352-8
-stereo FM radio 88-108 MHz met geluidsbegrenzer (82dB(A))
-3,5mm AUX ingang
-2x3,5mm stereo stekkers inbegrepen
-2x1,5V AA batterijen – ongeveer 130 gebruiksuren
-zachte, wisselbare hoofdbandbekleding
-brede, gemakkelijk wisselbare oorkussentjes

Order nr.	380682005	380682021	380682047
Orig. nr.	ZE412RD	ZE412R	ZE412D
Demping dB (SNR)	30	30	30
Beschermingsniveau	2	2	2
Aux in	✓	✓	✓
FM Radio	✓	✓	x
Level dependent	✓	x	✓
Prijs	€ 166,00	94,50	168,00



Comfortabele oorkap voor helm. Goede bescherming tegen lage en hoge frequenties. Verstelbare hoofdband en brede oorkussentjes.
-conform EN 352-1
-zachte en wisselbare hoofdbandbekleding
-brede, gemakkelijk wisselbare oorkussentjes
Helm niet inbegrepen.

Order nr.	380682013	380682039	380682054
Orig. nr.	ZE412RDH	ZE412RH	ZE412DH
Demping dB (SNR)	29	29	29
Beschermingsniveau	2	2	2
Aux in	✓	✓	✓
FM Radio	✓	✓	x
Level dependent	✓	x	✓
Prijs	€ 167,00	94,50	168,00

ZEKLER



Gezichtschermbreuk te gebruiken in combinatie met hoofd en/of oorbekkerung.

Order nr.	380686006	380686014	380686022	380686030
Orig. nr.	ZE67PC200	ZE67PC200C	ZE67PC250	ZE67AC200
Breedte mm	200	200	200	200
Dikte mm	1	1	1	1
Hoogte mm	200	220	220	200
Te gebruiken met	61A, 61B, 61E en 61F	61B, 61E, 61F	61A, 61B, 61F	61B, 61E, 61F
Norm	EN166, klasse 1B9	EN166, klasse 1B9	EN166, klasse 1B9	EN166, klasse 1FN
Materie	polycarbonaat	polycarbonaat	polycarbonaat	cellulose acetaat
Extra	-	kinbescher- ming	anti-condens	anti-condens
Prijs	€ 22,50	31,90	29,50	36,50

ZEKLER



Gezichtschermbreuk met gasvizier. Roestvrij stalen gaas.

Order nr.	380686055	380686063
Orig. nr.	ZE67ME185	ZE67MS185
Breedte mm	200	200
Hoogte mm	185	185
Te gebruiken met	61A, 61F, 61E, 61B	61A, 61F, 61E, 61B
Norm	EN 1731 klasse S	EN 1731 klasse S
Doorzichtigheid	82-85,5%	67-70%
Prijs	€ 68,50	15,50

ZEKLER



Comfortabele bevestiging voor gezichtschermbreuk, wanneer een helm en hoorbeschermbreuk niet gebruikt wordt. Verstelbare hoofdbekkerung en elastische halsband verzekeren comfort. Geschikt voor 67PC200, 67PC200C, 67PC250, 67AC200, 67ME185 en 67MS185. De combinatie gezichtschermbreuk en bevestiging is conform EN166 en EN1731.

Order nr.	380686543
Orig. nr.	ZE61B
Prijs	€ 26,50

ZEKLER



Clips voor het bevestigen van gezichtschermbreuk op helm, zonder hoorbeschermbreuk. Geschikt voor 67PC200, 67PC200C, 67PC250, 67AC200, 67ME185 en 67MS185. De combinatie gezichtschermbreuk en houder is conform EN166 en EN1731.

Order nr.	380686527
Orig. nr.	ZE61E
Prijs	€ 7,60

ZEKLER



Gezichtschermbreukhouder voor helm, geschikt voor alle Zekler hoorbeschermbreuk serie 400 voor helmbevestiging. Geschikt voor 67PC200, 67PC200C, 67PC250, 67AC200, 67ME185 en 67MS185. De combinatie gezichtschermbreuk en houder is conform EN166 en EN1731.

Order nr.	380686535
Orig. nr.	ZE61F
Prijs	€ 22,50

ZEKLER



OORDOPJES. Gele wegwerpoordopjes ear classic.
 -conform CE EN 352
 -demping : 28db (SNR)
 -ideale beschermbreuk bij werkzaamheden die permanente hoorbeschermbreuk vereisen
 -gemaakt van geschuimd polymeer en past in de meeste gehoorgangen
 -dermatologisch veilig schuim
 -klassieke roll-down oordop, gemakkelijk in te brengen.
 VE = verpakkingseenheid.

Order nr.	012300059
Orig. nr.	JOD250
Verpakking	doos
VE	250
Prijs/VE	€ 96,50



HEARING PROTECTION

Hearing is one of your most important senses and we would like to show you the best way to protect your hearing when you are at work. First and foremost 100% usage applies and to wear hearing protectors an entire day means they must fit perfectly and make you feel content and at ease.

★ HEY! LOOK ★

In order to achieve the best hearing protection, it is important to know what levels of noise are in the surrounding environment as well as in

what frequencies the sound occurs. This means the noise environment where you work needs to be measured. The results of the measured noise environment are used when choosing your hearing protectors. The recorded attenuation capability of hearing protectors together with the results of the measured noise environment provide a picture of the expected protection given by a pair of hearing protectors.

MEASUREMENT METHODS

The attenuation capability of the hearing protection is described in the methods set out below. The various attenuation values are stated for each hearing protector in the product section or in the User guide supplied with the hearing protectors.

OCTAVE BAND METHOD

used to determine the attenuation of the hearing protection in terms of average value and standard deviation in the eight octave bands required by the standard.

H-M-L

are used to measure hearing protector attenuation in high (H), medium (M) and low frequency dominated (L) noise.

SNR

(SINGLE NUMBER RATING) is a simplified description of hearing protector attenuation. A value is calculated based on the hearing protector's octave band values.

ATTENUATION LEVELS

To simplify the choice we have divided the protectors into three levels.

1
LEVEL ONE

Level 1. Good attenuation that suits a low noise level in industrial environments. Especially good attenuation at medium and high frequencies.

3
LEVEL THREE

Level 3. Extra high attenuation particularly medium and low frequencies.

2
LEVEL TWO

Level 2. Higher attenuation in both low and high frequencies, for a more demanding noise environment.

It is important to choose protection that does not "over attenuate". We can only tolerate a certain amount of noise per day before we risk permanent hearing damage. Factors that have an effect are the noise intensity and the time we spend in the noisy environment. For example, we are affected as much by 15 minutes at 100 dB(A) as 8 hours at 85 dB(A). Remember that it is not just in the workplace that your hearing may be affected by noise.

Well-designed protection has a noise level of between 70 and 80 dB (A) under the cups. This is to prevent being isolated and it should be possible to hear sounds in the surrounding environment. If the right protection is chosen there is a far greater chance that it will be used throughout the shift, which is a prerequisite to obtain the desired protective effect. Even a short period of "carelessness" can seriously reduce the effect of the hearing protection.

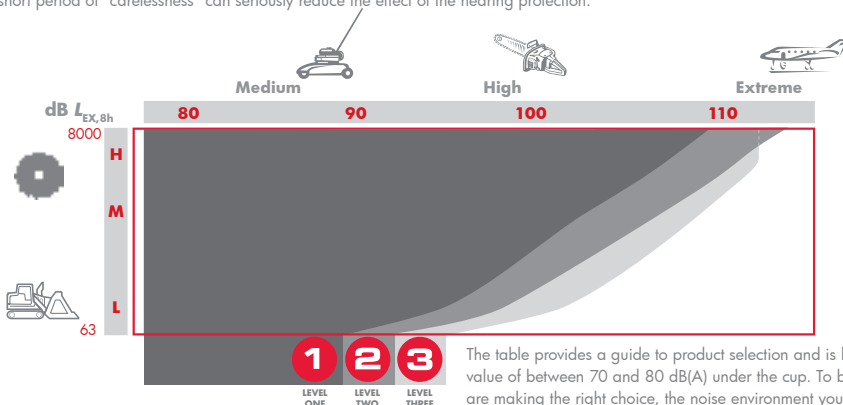

The table provides a guide to product selection and is based on the expected value of between 70 and 80 dB(A) under the cup. To be absolutely sure you are making the right choice, the noise environment you work in must be measured and calculated together with the hearing protector attenuation values.



TYPE OF PROTECTION



HEADBAND

An adjustable headband with fork attachment for the cups. The combination together with the cup's wide sealing cushions give a comfortable protector that can be used for long periods. The soft headband cushion pad and sealing cushions are easily replaceable.



NECKBAND

Plastic coated stainless steel neckband. Together with the cup's wide sealing cushions it provides a uniform band pressure and comfortable use. For use with other protective equipment, e.g. a visor, welding helmet or hard hat.



VISOR SYSTEM

Zekler Visor System can be combined with a headband and hard hat attachment in the Zekler 400 series and with a separate head frame. There is also a separate attachment for hard hat mounting. This is used when you do not use hearing protection with the hard hat. See visor in the Eye protection chapter on pages 28-29.



HARD HAT MOUNTING

For attaching on a hard hat (30 mm slot attachment) The band with fork attachment of the cups together with the wide sealing cushions provide uniform headband pressure and comfortable use. The hard hat adapter is prepared for mounting a Zekler visor system.

APPROVED FOR ATTACHMENT ON THESE HARD HATS

IRIS 2	Balance AC
Style 300	Balance HD
Style 600	Peltor G2000
	Peltor G3000



ACCESSORIES

Old, rigid and/or worn sealing cushions impair the hearing protector's attenuation capacity and noise "leaks in". Maintain protection performance and comfort by replacing the sealing cushions regularly.

If you work in extremely dirty environments or share the protection with others we recommend that you fit the sealing rings with a hygienic disposable cover.

ELECTRONIC FUNCTIONS



FM RADIO

FM RADIO

Allows you to listen to the radio instead of noise without disturbing anyone else. Promotes job satisfaction, while increasing the use of the hearing protectors. Level restrictors in the cups make it impossible to deliver dangerously high sound levels

in the speakers.



LEVEL DEPENDENT

LEVEL DEPENDENT SYSTEM

The function is exactly that "Level dependent". The microphones pick up the ambient noise so you can hear what's going on around you and facilitate communication with your colleagues. Should the sound reach harmful levels the electronics react immediately and take down the level to max. 82 dB. Extremely good in environments with impulse noise, or varying levels of noise. The volume control also allows you to increase the ambient noise and still feel safe. The function reduces the risk of over attenuation and gives you the opportunity of using the protection at all times when there is a risk of damaging noise levels.



AUX IN

AUX INPUT

3.5 mm audio input for connecting an external audio source, such as MP3 player or FM radio.





We are serious about work.
(So you don't have to worry about that)

Let us at Guide take care of all the practical details of your job, at least when it comes to gloves. We take your job seriously and have what it takes to make your days at work safer, better and more fun.



Guidoball
RACE

55

GUIDE
The right gloves

Chemical protection table

Chemical	CAS No.	Guide 4011 Nitrile Permeation time	GUIDE 4012 Latex/Neoprene Permeation time	Guide 4013 Neoprene Permeation time	Guide 4014 Nitrile Permeation time	Guide 4015 Nitrile Permeation time	Guide 4016 Latex Permeation time
Acetic Acid 99%	64-19-7	> 120	> 240	> 480	> 120	> 120	> 60
Acetone	67-64-1	< 10	> 30	> 30	< 10	< 10	> 10
Ammonia 10%	1336-21-6	> 480	> 240	> 240	> 480	> 480	> 120
Ammonia Acetate	631-61-8	> 480	> 480	> 480	> 480	> 480	> 480
Ammonia Chloride	12125-02-9	> 480	> 480	> 240	> 480	> 480	> 480
Ammonia Nitrate	6484-52-2	> 240	> 480	> 480	> 240	> 240	> 60
Calcium Chloride	10043-52-4	> 240	> 240	> 480	> 240	> 240	> 240
Calcium Hydroxide	1305-62-0	> 240	> 240	> 480	> 240	> 240	> 240
Calcium Hypochloride	7778-54-3	> 240	> 480	> 480	> 240	> 240	> 240
Calcium Nitrate	10124-37-5	> 480	> 480	> 240	> 480	> 480	> 240
Carbon Tetra Chloride	56-23-5	> 120	< 10	< 10	> 120	> 120	> 30
Chloroform	865-49-6	< 10	< 10	< 10	< 10	< 10	> 10
Citric Acid (Pure)	77-92-9	> 480	> 480	> 480	> 480	> 480	> 480
Cyclo-hexane	110-82-7	> 480	> 10	> 30	> 480	> 480	> 60
Cyclo-Hexanol	108-93-0	> 480	> 480	> 480	> 480	> 480	> 240
Diesel Oil	68334-30-5	> 480	> 60	> 240	> 480	> 480	< 10
Diethylether	60-29-7	> 60	< 10	< 10	> 60	> 60	> 10
Diethylamine	109-89-7	> 60	< 10	< 10	> 60	> 60	< 10
DOP	117-84-0	> 480	> 480	> 480	> 480	> 480	> 480
Ethanol	64-17-5	> 240	> 30	> 240	> 240	> 240	> 60
Ethylene Glycol	107-21-1	> 480	> 480	> 480	> 480	> 480	> 480
Formaldehyde 30%	50-00-0	> 480	> 480	> 480	> 480	> 480	> 480
Formic Acid 90%	64-18-6	> 60	> 240	> 480	> 60	> 60	> 120
Glycerine	56-81-5	> 480	> 480	> 480	> 480	> 480	> 480
Glycol	111-46-6	> 480	> 480	> 480	> 480	> 480	> 480
Heptane	142-82-5	> 480	< 10	> 30	> 480	> 480	< 10
Hexane	110-54-3	> 480	> 10	> 60	> 240	> 240	> 10
Hydrochloric Acid (30%)	7647-01-0	> 240	> 480	> 480	> 240	> 240	> 120
Hydrofluoric Acid (14%)	7664-39-3	> 480	> 480	> 480	> 480	> 480	> 480
Hydrogen Peroxide 31%	7722-84-1	> 480	> 120	> 480	> 480	> 480	> 480
ISO-Propanol	67-63-0	> 480	> 60	> 240	> 480	> 480	> 60
Kerosene	8008-20-6	> 480	> 480	> 120	> 480	> 480	> 60
Methanol	67-56-1	> 60	> 240	> 60	> 30	> 30	> 30
Methylene Chloride	27639	< 10	< 10	> 10	< 10	< 10	< 10
Methylethylketone (MEK)	78-93-3	< 10	> 10	> 10	< 10	< 10	> 10
Nitric Acid 20%	7697-37-2	> 480	> 480	> 480	> 480	> 480	> 480
Octane	111-65-9	> 480	> 30	> 30	> 480	> 480	> 10
Oliec Acid	112-80-1	> 480	> 480	> 480	> 480	> 480	> 480
Oxalic Acid (Pure)	144-62-7	> 480	> 480	> 480	> 480	> 480	> 480
Paraffin oil	8012-95-1	> 480	> 480	> 480	> 480	> 480	> 480
Phosphoric Acid (85%)	7664-38-2	> 480	> 480	> 480	> 480	> 480	> 480
Potassium Nitrate	7757-79-1	> 480	> 480	> 30	> 480	> 480	> 60
Potassium Phosphate	2139900	> 480	> 480	> 480	> 480	> 480	> 480
Sodium Nitrate	7631-99-4	> 480	> 480	> 30	> 480	> 480	> 60
Sodium Phosphate	7601-54-9	> 480	> 480	> 480	> 480	> 480	> 480
Sodium Sulphate	7757-82-6	> 480	> 480	> 480	> 480	> 480	> 480
Sulphuric Acid 98%	7664-93-9	> 60	> 240	> 120	> 30	> 30	> 30
Tetrahydrofuran (THF)	109-99-9	< 10	< 10	< 10	< 10	< 10	< 10
Toluene	108-88-3	> 30	< 10	> 10	< 10	< 10	< 10

EN standards for protective gloves

Protective gloves are divided into three categories depending on type and which risk or danger the gloves are to protect against:



CATEGORY 1 - gloves used in minimal risk situations.

Examples of gloves in this category are household gloves for protection against washing powder, detergents, cleaning fluids, and gloves for protection against heated objects or temperatures not exceeding +50° C. Other gloves in this category can be used for lighter jobs, for example gardening or tasks where there is only a slight risk of injury.



CATEGORY 2 - all types of gloves not classified under categories 1 or 3.

This category covers gloves that are used where the risks involved are neither minimal nor complex. There is a requirement for gloves in this category to be tested by an accredited institute and to be type approved by a notifiable body. These gloves must be marked with a pictogram showing the glove's protective function. This category often covers gloves that protect against mechanical risks in accordance with EN 388.



CATEGORY 3 - gloves that are to be used in hazardous environments and where there is a significant risk for serious injury.

Gloves in this category are used when there is a risk of serious or permanent injury, for example involving the handling of dangerous chemicals. In order for these gloves to be CE marked they have to be tested by an accredited institute, type approved by a notifiable body and be subjected to manufacture control of the product or production process.

EN-420

General requirements for protective gloves

All gloves in this catalogue meet the basic requirements

- The gloves in themselves shall not constitute a risk or cause injury.
- The glove material shall have a neutral pH value, wherein leather gloves must fall into the range of 3.5-9.5.
- The highest allowable limit for chromium content is 3 mg/kg (hex chrome).
- The manufacturer must declare if any known substance is present that may be allergenic.
- The size of the gloves is also standardised - for, amongst other things, the minimum length.

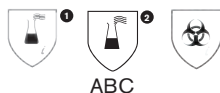

EN-374

Protection against chemicals and micro-organisms

In Sweden there are around 15 000 different substances estimated as being used in 70 000 products within commerce, industry, households, agriculture, etc. Tested and approved chemical protection gloves are the only correct solution for protection against many of these chemicals. There are only two things you need to know - the name of the chemical, its datasheet information if available, and the length of time you estimate to be in contact with it. We can then help you to select

the right glove. Those gloves which are not certified in accordance with EN 374-2003, but which are certified to the old EN 374-1994 have this pictogram: (1). If the chemical protection glove is certified in accordance with EN 374-2003, it has this pictogram: (2).

Scope

This standard specifies the glove's performance concerning the protection of the user against chemicals and/or micro-organisms.

Definitions - The gloves length of life

Degradation has a detrimental effect on one or more elements of the glove's material. The speed of degradation depends on the type of chemical the glove has been in contact with.

Penetration

Means the chemical's and/or microorganism's route through porous materials, seams, pinholes or through imperfections, at a non-molecular level, in the glove's protective film.

Permeation - the glove's protective film in, e.g. natural rubber or plastic is not always a protective barrier against chemicals. If the surface of the glove is porous it can in certain cases function as a sponge, absorbing chemicals, and thereby also penetrate the glove material and reach the skin faster. It is therefore of the utmost importance to measure the penetration time, or the time it takes for a chemical to penetrate the protection film and come into contact with the skin.

Measured

- **Density:** The shortest allowable length that is sealed against liquids is to equal the minimum length of the gloves as specified in EN 420.
- **Penetration:** The glove shall show no sign of leakage in tests with air and/or water, and shall be tested in accordance with an accepted quality level - the so-called AQL level.

The pictogram for chemical protection gloves must display a code consisting of at least 3 letters. These refer to the code letters for 3 chemicals (from a list of 12 defined standard chemicals - refer to the table below), which have achieved a penetration time of a minimum of 30 minutes.



Performance levels	Accepted Quality Level according AQL	Inspection levels
Level 3	> 0.65	G1
Level 2	> 1.5	G1
Level 1	> 4.0	S4

Code	Chemical	CAS Number	Category
A	Methanol	67-56-1	Primary alcohol
B	Acetone	67-64-1	Ketone
C	Acetone nitrile	75-05-08	Nitrile compound
D	Dichloromethane	75-09-2	Chlorinated paraffin
E	Carbon sulphide	75-15-0	Sulphur containing an organic compound
F	Toluene	108-88-3	Aromatic hydrocarbon
G	Diethylamine	109-89-7	Amines
H	Tetrahydrofuran	109-99-9	Heterocyclic and etheric compound
I	Ethyl acetate	141-78-6	Ester
J	n-Heptane	142-85-5	Saturated hydrocarbons
K	Sodium Hydroxide 40%	1310-73-2	Inorganic base
L	Sulphuric acid 96%	7664-93-9	Inorganic mineral acid

Permeation: Each tested chemical is classed according to its permeation time (level 0 to 6)

Measured permeation time	Protection index
> 10 minutes	Cat 1
> 30 minutes	Cat 2
> 60 minutes	Cat 3
> 120 minutes	Cat 4
> 240 minutes	Cat 5
> 480 minutes	Cat 6



The pictogram for "Low chemical protection" or "Liquid seal" (1) must be displayed in cases where the gloves have not achieved a penetration time of a minimum of 30 minutes against at least three chemicals from the above list, but that meet the requirements of the penetration test. The pictogram for "Micro-organisms" (2) must be displayed when the glove achieves a minimum of performance level 2 in the penetration test. The table at the side gives a general overview of different glove materials that afford suitable protection against different groups of chemicals.

Groups of chemicals	Natural rubber	Nitrile	Neoprene	PVC	PVA	Butyl
Solvents	X	X	-	-	-	
Ketones	X	-	X	-	X	X
Acids	X	X	X	X	-	
Hydrocarbons	-	X	X	-	X	
Oils	-	X	X	X	X	
Grease	-	X	X	X	-	
Organic solvents	X	X	X	-	X	

Caution: This information about chemicals cannot always reflect the actual time of usage at the workplace. It is therefore important to establish which glove is suitable for use and its effective length of protection in each work situation.

EN-455

Requirements for medicinal disposable gloves

This standard specifies requirements and testing methods concerning disposable gloves for medicinal use. Requirements are made and measured regarding, inter alia.

- Density.
- Sizing
- Durability and thickness.
- Tensile strength before and after accelerated ageing.
- Biological safety.



EN-388

Protection against mechanical hazards



Four properties are tested. All gloves that have been tested and approved in accordance with EN388 shall in conjunction with the pictogram for this EN norm, display the performance level in a 4 figure code wherein the recorded test result can be seen.

1. Abrasion resistance

The material is subjected to abrasion using sandpaper under a pre-determined pressure. The protective function is then stated according to a scale of 1 to 4 depending on how many revolutions

are required to breach the material. The higher the figure in the table, the better the glove is - refer to the table.

2. Blade cut resistance

The least number of revolutions is counted (using a rounded cutting blade) to cut through the glove material. The protective function is stated on a scale of 1 to 5 where 5 is the best result.

3. Tear resistance

The force required to tear apart the glove material is recorded. The protective function is stated on a scale of 1-4.

4. Puncture resistance

The amount of force required to puncture the glove material with a point. The protective function is stated on a scale of 1-4.



Static electricity

The pictogram by the glove indicates that the glove is approved and resistant to electrostatic charges.

If a glove achieves a 0 result in any of the tests, it means that that particular glove falls below the minimum performance requirements for a particular risk factor.

If any of the test results are marked with a X, it means that the physical properties were not tested.

Test	Performance levels				
	1	2	3	4	5
Abrasion resistance (cycles)	100	500	2000	8000	
Blade cut resistance (factor)	1,2	2,5	5	10	20
Tear resistance (newton)	10	25	50	75	
Puncture resistance (newton)	20	60	100	150	

EN-511

Protection against cold



Measurements are made to determine how the material in the glove conducts cold, and the material's insulation properties (on contact) The last figure in conjunction with the pictogram indicates if water permeation occurred after 30 minutes. In conjunction with the pictogram a 3 figure code is shown.

• The first figure indicates the resistance to gradually penetrating cold (performance level 0-4)

• The second figure indicates the resistance for direct contact with cold objects (performance level 0-4) The higher the performance level, the better the insulation properties.

• The third figure indicates the resistance to water permeation (performance level 0 or 1)

0 = water permeation after 30 min
1 = no water permeation after 30 min



EN-407



Protection against heat

The figures by the pictogram for EN standard indicates which result the glove has attained in each test. The higher the figure, the better the result. The following elements have been tested:

1. Resistance to flammability

The glove material is fixed into position and is set alight with a gas flame. The flame shall be held against the material for at least 15 sec. After the flame has been extinguished the glow or afterburn time is measured.

2. Resistance to contact heat

The glove material is exposed to temperatures between + 100°C and 500°C. Following this, the time taken for the inside of the material to become 10° warmer than the starting temperature of the material (approx 25°C) is measured. The time must be exactly 15 seconds to be approved. Exception- for class 2 the inside of the glove material must withstand at least 250°C for 15 seconds before the material exceeds 35°C.

3. Resistance to convective heat

Here the length of time taken for a gas flame (80Kw/m²) to increase the heat on the inside of the glove material by 24° is measured.

4. Resistance to radiant heat

The glove material is fixed into position in front of a heat source with an effect of 20-40 kW/m². The average time for heat penetration of 2.5 kW/m² is measured.

5. Resistance to small splashes of molten metal

A test based on a number of drops of molten metal which causes the temperature between material and the skin to increase by 40°.

6. Resistance to large splashes of molten metal

An artificial skin made from PVC is fastened to the inside of the material. Then molten iron is poured onto the glove material. Measurements are taken of the amount of grammes of molten iron required to damage the PVC film.

Test No	Results are measured in:		Result levels			
			1	2	3	4
1.	After-burn time	Seconds	≤ 20	≤ 10	≤ 3	≤ 2
1.	After-glow time	Seconds	infinite	≤ 120	≤ 25	≤ 5
2.	Contact heat	Temp °C after 15 sec.	100°	250°	350°	500°
3.	Convective heat	Seconds	≤ 4	≤ 7	≤ 10	≤ 18
4.	Radiant heat	Seconds	≤ 5	≤ 30	≤ 90	≤ 150
5.	Drops of molten metal	Number of drops	≥ 5	≥ 15	≥ 25	≥ 35
6.	Molten metal	Gram	30	60	120	200

≥ Is equal to or greater than ≤ = Is equal to or less than



EN 10819

Protection against vibration – vibration attenuation

The standard states that the glove may not amplify vibrations at a medium level frequency (31.5 Hz to 200 Hz).

At high frequency (200 Hz to 1250 Hz), the glove must reduce the vibration level by 40%.



EN 12477

Welding gloves

This standard describes how the glove must be shaped in order to provide protection for the hand and wrist during welding and similar tasks, and is a combination of tests covered by EN 388 and EN 407.

Welding gloves must provide good protection against splashes of molten metal, short-term exposure to naked flames, radiation heat and conductive heat.

EN 12477 also has minimum requirements concerning the glove's length. In addition, welding gloves must protect against mechanical risks. The gloves are also judged according to their design and purpose where:

Type A indicates gloves that must provide a slightly higher degree of protection against heat.

Type B indicates gloves that provide a slightly lower degree of protection against heat, but which have higher flexibility and versatility.

EN 60903

Electrical risks

In order to protect against electrical risks you'll need to use special gloves. Gloves that are manufactured and approved in accordance with EN standard 60903 are the only ones you can use where there is a risk of electric shock.

In order to establish which glove gives the best protection, it is important to know the level of voltage that can occur.

Which glove for which voltage - see below.

In order to protect the gloves against hard wear, sharp cable ends, etc., there are also suitable gloves to put on over them.

Class work at:	Tested at:	Approved for
00	2500 V	500 V
0	5000 V	1000 V
1	10 000 V	7500 V
2	20 000 V	17 000 V
3	30 000 V	26 500 V
4	40 000 V	36 000 V



Handschoenen voor precisiewerk



Vingergevoelige handschoenen in nylon met een poreuze nitril coating.
 -conform CE Cat.2 EN 388-4121
 -toepassing : automotive-assemblage
 -excellente vingergevoeligheid en draagcomfort (naadloos gebreid nylon)
 -vocht- en olieafstotend
 -poreuze nitrilcoating voor uitstekende grip
 -open rug voor ventilatie

Order nr.	Orig. nr.	Maat	Verpakking	VE	Min. bestelhoeveelheid	Prijs/VE
223600867	GU540217C	7	carded	1	6	2,40
223510215	GU540217B	7	non-carded	1	12	2,00
223600875	GU540218C	8	carded	1	6	2,40
223510223	GU540218B	8	non-carded	1	12	2,00
223600883	GU540219C	9	carded	1	6	2,40
223510231	GU540219B	9	non-carded	1	12	2,00
223600891	GU5402110C	10	carded	1	6	2,40
223510249	GU5402110B	10	non-carded	1	6	2,00



Soepele handschoenen in nylon met nitrile coating.
 -naadloos gebreid voor beter comfort
 -goede grip
 -open rug voor ventilatie
 -nitrile coating op vingertoppen en handpalm
 -minimum besteleenheid non carded 12 paar
 Verpakt in kartons van 120 paar

Order nr.	223540584	223540592
Orig. nr.	GU5809B	GU58010B
Maat	9	10
Verpakking	non-carded	non-carded
VE	1	1
Min. bestelhoeveelheid	12	12
Prijs/VE	€ 4,40	4,40



Waterproof nylon handschoenen met latex coating.
 -volledig gecoate handschoenen
 -beschermt tegen de vochtigheid
 -houdt de handen droog zelfs in extreme condities
 -zeer goede grip
 -minimum besteleenheid non carded 12 paar

Verpakt in kartons van 120 paar

Order nr.	223542663
Orig. nr.	GU58510B
Maat	10
Verpakking	non-carded
VE	1
Min. bestelhoeveelheid	12
Prijs/VE	€ 6,40



Handschoenen voor precisiewerk in nylon met een PU-coating.
 -conform CE Cat.2 EN 388-4131
 -toepassing : assemblage-automotive
 -naadloos gebreid voor beter comfort en extra hoog vingertipgevoel
 -PU-coating op de vingertoppen voor een goede grip en bescherming

Order nr.	Orig. nr.	Maat	Verpakking	VE	Min. bestelhoeveelheid	Prijs/VE
223530858	GU525217B	7	non-carded	1	12	1,40
223530866	GU525218B	8	non-carded	1	12	1,40
223530874	GU525219B	9	non-carded	1	12	1,40
223530882	GU5252110B	10	non-carded	1	12	1,40
223530890	GU5252111B	11	non-carded	1	12	1,40

Handschoenen voor assemblage en licht werk

GUIDE



- Zeer plooibare handschoen in water-en olieafstotend, met Teflon behandelde Clarino.
- conform CE Cat.2 EN 388-2131
- toepassing : bouw
- wasbaar 40°C
- versterkte vingertoppen
- handpalm water-en olieafstotend
- rug in flexibel en beschermend Spandex
- velcro sluiting

Order nr.	223559972
Orig. nr.	GU500511C
Maat	11
VE	1
Min. bestelhoeveelheid	3
Prijs/VE	€ 25,90

GUIDE



- Zeer plooibare handschoen.
- conform CE Cat.1 EN 388-1131
- toepassing : bouw
- wasbaar 40°C
- versterkte vingertoppen
- versterkte handpalm met speciale grip (zelfs nat)
- rug in flexibel en beschermend Spandex
- velcro sluiting

Order nr.	223521030
Orig. nr.	GU501011C
Maat	11
VE	1
Min. bestelhoeveelheid	3
Prijs/VE	€ 24,50

GUIDE



- Flexibele, lichte handschoen in Golf Verde PU materiaal.
- conform CE Cat.2 EN 388-1111
- toepassing : fijn mechanisch werk
- goed vingergevoel
- wasbaar 40°C
- rug in zacht synthetisch materiaal
- velcro sluiting

Order nr.	223535576
Orig. nr.	GU57011C
Maat	11
VE	1
Min. bestelhoeveelheid	3
Prijs/VE	€ 18,50

GUIDE



- Lichte handschoen in zacht en slijtvast varkensnerfleder.
- conform CE Cat.1 EN 420
- toepassing : assemblagewerk-automotive-verpakken
- versterkte vingertoppen, wijsvinger en naden
- rug in elastisch katoen
- velcro sluiting

Order nr.	223520925	223520933	223520941
Orig. nr.	GU439B	GU4310B	GU4311B
Maat	9	10	11
Verpakking	non-carded	non-carded	non-carded
VE	1	1	1
Min. bestelhoeveelheid	12	12	6
Prijs/VE	€ 6,10	6,10	6,10

GUIDE



Soepele, plooibare handschoen in gebreid katoen/polyester met latex coating.
 -conform CE Cat. 2 EN388-2243
 -toepassing : bouw-industrie
 -naadloos gebreid voor beter comfort
 -goede droge en natte grip
 -latex coating op palm en vingertoppen
 -open rug voor ventilatie
 Verpakt in kartons van 120 paar.

Order nr.	223530734	223530742
Orig. nr.	GU1509B	GU15010B
Maat	9	10
Verpakking	non-carded	non-carded
VE	1	1
Min. bestelhoeveelheid	12	6
Prijs/VE	€ 2,60	2,60

GUIDE



Handschoen in keperdoek met noppen in pvc.
 -conform CE Cat.1 EN 420
 -toepassing : verpakking-automotive-tuinbouw
 -gewicht : 7oz
 -zwarte noppen in pvc op handpalm, duim en wijsvinger voor een betere grip
 -polsboord

Order nr.	223532193
Orig. nr.	GU42010B
Verpakking	non-carded
Maat	10
VE	1
Min. bestelhoeveelheid	12
Prijs/VE	€ 1,40

GUIDE



Soepele, elastische handschoen in geitenleder.
 -conform CE Cat.2 EN 388-2121
 -toepassing : automotive-assemblagewerk-verpakken
 -versterkte wijsvinger
 -rug in synthetisch elastisch materiaal
 -gevoerd

Order nr.	Orig. nr.	Maat	Verpakking	VE	Min. bestel-hoeveelheid	Prijs/VE
223533696	GU308B	8	non-carded	1	12	5,40
223533704	GU309B	9	non-carded	1	12	5,40
223533712	GU3010B	10	non-carded	1	12	5,40
223533720	GU3011B	11	non-carded	1	12	5,40

GUIDE



Soepele handschoen in geitenleder
 - Conform EE Cat. 2 EN 388 2111
 - Toepassing: automotive-assemblagewerk-verpakken
 - Versterkte wijsvinger en vingertoppen
 - Rug in synthetisch elastisch materiaal
 - Niet gevoerd

Order nr.	223600065
Orig. nr.	GU516110C
Maat	10
VE	1
Min. bestelhoeveelheid	12
Prijs/VE	€ 7,20

Handschoenen voor zwaarder werk



Slijtvaste handschoenen in kwaliteits rundssplit leder.
 -conform CE Cat.2 EN 388-3123
 -toepassing : bouw-industrie
 -versterkte vingertoppen en wijsvinger
 -rug in groen katoen/knokkelbescherming
 -kap in rubber van 7cm
 -half gevoerd in katoen op handpalm
 Verpakt in kartons van 120 paar.

Order nr.	223533456
Orig. nr.	GU19310B
Maat	10
Verpakking	non-carded
VE	1
Min. bestelhoeveelheid	12
Prijs/VE	€ 5,20



All-round handschoen gemaakt in soepel en duurzaam rundsnerf leder.

- conform Cat.1 EN 420
 - toepassing : bouw en industrie
 - versterkte wijsvinger en vingertoppen
 - versterkte knokkels
 - half gevoerd met katoen
 - rug van de hand is van zacht katoenen materiaal

Order nr.	223531906
Orig. nr.	GU19511B
Maat	11
Verpakking	non-carded
VE	1
Min. bestelhoeveelheid	12
Prijs/VE	€ 10,50



Handschoen in blauw nitril.

- conform CE Cat.2 EN 388-4211
 - toepassing : automotive-assemblage-bouw, handelingen met scherpe en ruwe materialen in de steen-hout-metaal industrie.
 - hoge weerstand tegen oliën, vetten en oplosmiddelen
 - gladde nitril coating op handpalm en 3/4 op rug
 - open rug voor ventilatie
 - manchet voor extra bescherming van de pols
 - zachte katoenvoering

Order nr.	223600446	223533977
Orig. nr.	GU80210C	GU80210B
Maat	10	10
Verpakking	carded	non-carded
VE	1	1
Min. bestelhoeveelheid	12	12
Prijs/VE	€ 3,70	3,40



Handschoen in blauw nitril.

-conform CE Cat.2 EN 388-4111
 -toepassing : automotive-assemblage-bouw
 -hoge weerstand tegen oliën, vetten en oplosmiddelen
 -gladde nitril coating op handpalm en 3/4 op rug
 -open rug voor ventilatie
 -tricot boord
 -zachte katoenvoering

Order nr.	223534066
Orig. nr.	GU80410B
Maat	10
Verpakking	non-carded
VE	1
Min. bestelhoeveelheid	12
Prijs/VE	€ 3,30





Soepele, plooibare handschoen in gebreid nylon met nitrile coating. Conform CE Cat.2 en 388-4121.

- Toepassing: bouw-industrie
- Naadloos gebreid voor beter comfort
- Goede droge en natte grip
- Nitrile coating op palm, vingertoppen en rug
- Waterbestendig

Verpakt in kartons van 120 paar.

Order nr.	223603465
Orig. nr.	GU58310C
Maat	10
VE	1
Min. bestelhoeveelheid	12
Prijs/VE	€ 4,10



Volledig gevoerde synthetische winter werkhandschoenen.

- conform CE cat.2 EN388-2221, EN511-12X
- toepassing : constructie en industrie in koude omgevingen
- waterdicht membraan in de handpalm
- gevoerd
- rug in hi-viz flexibele spandex.

Order nr.	223603184
Orig. nr.	GU5148W10C
Maat	10
VE	1
Min. bestelhoeveelheid	6
Prijs/VE	€ 8,20



Handschoen in begreid bamboe vezel met latex coating.

- conform CE Cat.1 en EN420
- toepassing: bouw, industrie, automotive en tuin latex coating op palm en vingers
- open rug voor ventilatie
- tricot boord

Verpakt in kartons van 120 paar.

Order nr.	223603390
Orig. nr.	GU16110C
Maat	10
VE	1
Min. bestelhoeveelheid	12
Prijs/VE	€ 5,30



Slijtveste handschoen in rundsplit leder.

- Conform CE Cat.2 EN 388-4032
- Toepassing : bouw-metaalindustrie
- Versterkte vingertoppen en wijsvinger
- Rug in rood katoen/knokkelbescherming
- Kap in rubber van 7cm
- Half gevoerd in katoen op handpalm/lederen handpalmversterking

Order nr.	320000052
Orig. nr.	GU50110B
Maat	10
VE	1
Min. bestelhoeveelheid	12
Prijs/VE	€ 2,90

Handschoenen voor wintertemperatuur



All-round winterhandschoenen in varkensnerfleder.
 -conform CE Cat.1 EN 420
 -toepassing : bouw-industrie
 -rug in katoen
 -microfleece wintervoering

Order nr.	223535261
Orig. nr.	GU18910B
Maat	10
Verpakking	non-carded
VE	1
Min. bestelhoeveelheid	12
Prijs/VE	€ 9,80



All-round winterhandschoenen in varkenssplitleder.
 - conform CE Cat.1 EN 420.
 - toepassing : bouw-industrie voor geringe risico's.
 - rug in katoen.
 - versterkte wijsvinger, vingertoppen en knokkels
 - volledig gevoerd
 - trapezium duim voor een hogere flexibiliteit en een hogere ergonomie

Order nr.	223500240	223500265
Orig. nr.	GU88W10B	GU88W11B
Maat	10	11
Verpakking	non-carded	non-carded
VE	1	1
Min. bestelhoeveelheid	6	6
Prijs/VE	€ 14,90	14,90



Soepele, plooibare winterhandschoenen in gebreid katoen/polyester met latex coating.
 -conform CE Cat.2 EN 388-1231, EN 511-010
 -toepassing : bouw-industrie-landbouw-tuinbouw
 -naadloos gebreid voor beter comfort
 -gepatenteerde micro finish voor goede droge en natte grip
 -latex coating op palm en vingertoppen
 -open rug voor ventilatie
 -warme en isolerende gebreide materie

Verpakt in kartons van 120 paar.

Order nr.	Orig. nr.	Maat	Verpakking	VE	Min. bestelhoeveelheid	Prijs/VE €
223534462	GU1588B	8	non-carded	1	12	8,00
223534470	GU1589B	9	non-carded	1	12	8,00
223534488	GU15810B	10	non-carded	1	12	8,00
223534496	GU15811B	11	non-carded	1	1	8,00



Volledig gevoerde synthetische winter werkhandschoenen.

- conform CE cat.2 EN388-2221, EN511-12X
 - toepassing : constructie en industrie in koude omgevingen
 - waterdicht membraan in de handpalm
 - gevoerd
 - rug in hi-viz flexibele spandex

Order nr.	Orig. nr.	Maat	Verpakking	VE	Min. bestelhoeveelheid	Prijs/VE €
223541467	GU5148W8B	8	non-carded	1	6	8,00
223541475	GU5148W9B	9	non-carded	1	6	8,00
223603176	GU5148W9C	9	carded	1	6	8,20
223541483	GU5148W10B	10	non-carded	1	6	8,20
223541491	GU5148W11B	11	non-carded	1	6	8,20
223603192	GU5148W11C	11	carded	1	6	8,80

Handschoenen voor snijbescherming

GUIDE



- Snijbestendige handschoenen in kevlar met pu/nitril coating.
- conform CE Cat.2 EN 388-4432
 - toepassing : glasbehandeling-metaalbewerking
 - automotive
 - uitstekend draagcomfort(naadloos gebreid synthetisch)
 - uitstekend tegen snij-en schuurrisico's
 - vocht-en olieafstotend
 - handpalm met coating voor goede grip
 - elastische polsboord



Order nr.	223539735
Orig. nr.	GU301108
Maat	10
Verpakking	non-carded
VE	1
Min. bestelhoeveelheid	3
Prijs/VE	€ 12,50

GUIDE



Gevoerde snijbestendige handschoenen.

- Naadloze aramidevezel
- Snijbeschermingsniveau 5
- Gevoerde latex palm
- Uitstekende grip



Order nr.	223540758
Orig. nr.	GU358108
Maat	10
Verpakking	non-carded
VE	1
Min. bestelhoeveelheid	6
Prijs/VE	€ 9,80

Handschoenen voor chemische bescherming

GUIDE



- Handschoenen tegen chemische producten in blauwe PVC
- conform CE Cat.3 EN 374/388-4121
 - toepassing : automotive-petrochemie-bouw
 - lengte 30cm
 - gestructureerd oppervlak voor een betere grip
 - zachte binnenvoering in katoen voor een beter comfort



Order nr.	223537788
Orig. nr.	GU143108
Maat	10
Verpakking	non-carded
VE	1
Min. bestelhoeveelheid	12
Prijs/VE	€ 6,90

GUIDE



- Handschoenen tegen chemische producten. Vervaardigd in rode PVC.
- conform CE Cat.3 EN 374/388-4121
 - toepassing : automotive-petrochemie-transport
 - lengte 40cm
 - bestendig tegen benzine/diesel,olie,amoniak en meststoffen
 - versterking tussen duim en wijsvinger
 - zachte binnenvoering in katoen voor een beter comfort



Order nr.	223537705
Orig. nr.	GU137108
Maat	10
Verpakking	non-carded
VE	1
Min. bestelhoeveelheid	12
Prijs/VE	€ 6,00

GUIDE



Chemisch bestendige handschoen in zwarte neopreen.
 -conform CE Cat.3 EN 374-2003/388-3131
 -toepassing : landbouw-tuinbouw-petrochemie-schoonmaak-industrie
 -dikte 0.75mm-lengte 33cm
 -bevat latex voor een betere plooibaarheid
 -zachte binnenvoering in katoen voor een beter comfort

Order nr.	223536319	223536327	223536335
Orig. nr.	GU40138C	GU4139C	GU41310C
Maat	8	9	10
Verpakking	carded	carded	carded
VE	1	1	1
Min. bestelhoeveelheid	12	12	12
Prijs/VE	€ 5,10	5,10	5,10

Lashandschoenen

GUIDE



Lashandschoen in soepel geitenleder.
 -conform EN12477 type B, EN 407-41X4XX, EN 388-3122
 -toepassing : MIG/TIG lassen
 -fijn vingertipgevoel
 -warmtebestendige kevlar draad in alle naden
 -zowel palm als rug in sterk en flexibel geitenleder
 -kap in sterk varkenssplitleder 12cm

Order nr.	223501776
Orig. nr.	GU24010B
Maat	10
Verpakking	non-carded
VE	1
Min. bestelhoeveelheid	12
Prijs/VE	€ 15,50

GUIDE



Lashandschoen in rundsplitleder.
 -conform EN12477 type A, EN 407-413X4X, EN 388-3243
 -toepassing : zwaar laswerk
 -warmtebestendige kevlar draad in alle naden
 -lengte 35cm
 -volledig gevoerd

Order nr.	223538380
Orig. nr.	GU28010B
Maat	10
Verpakking	non-carded
VE	1
Min. bestelhoeveelheid	6
Prijs/VE	€ 9,50

Textielhandschoenen

GUIDE

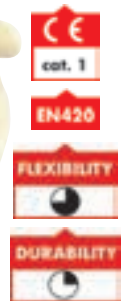

Handschoen in ongebleekt katoen.
 -conform CE Cat.1 EN 420
 -toepassing : verpakking-automotive
 -gebruikt als onderhandschoen in lederen handschoenen

Order nr.	223701632
Orig. nr.	GU405B
Verpakking	non-carded
Maat	10
VE	1
Min. bestelhoeveelheid	12
Prijs/VE	€ 0,60

EQUIPMENT



Handschoen in keperdoek.
-conform CE Cat.1 EN 420
-toepassing : verpakking-automotive-tuinbouw
-gewicht : 8oz
-polsboord

Order nr.	223532144
Orig. nr.	GU41010B
Verpakking	non-carded
Maat	10
VE	1
Min. bestelhoeveelheid	12
Prijs/VE	€ 1,10

Tuinhandschoenen



Soepele en comfortabele nylon tuinhandschoen, PU coating op handpalm. Extra grip en slijtweerstand. Conform CE cat. 1 EN420.

Order nr.	Orig. nr.	Verpak-king	Maat	Kleur	VE	Min. bestelhoeveelheid	Prijs/VE
223602327	GU5326C	carded	6	roze	1	12	1,70
223602335	GU5327C	carded	7	roze	1	12	1,70
223602343	GU5328C	carded	8	roze	1	12	1,70
223602350	GU5329C	carded	9	roze	1	12	1,70
223602368	GU53210C	carded	10	roze	1	12	1,70
223602392	GU5336C	carded	6	groen	1	12	1,70
223602400	GU5337C	carded	7	groen	1	12	1,70
223602418	GU5338C	carded	8	groen	1	12	1,70
223602426	GU5339C	carded	9	groen	1	12	1,70
223602434	GU53310C	carded	10	groen	1	12	1,70



Soepele en comfortabele nylon tuinhandschoen, PU coating op handpalm. Extra grip en slijtweerstand. Conform CE cat. 1 EN420.

Order nr.	Orig. nr.	Verpak-king	Maat	Kleur	VE	Min. bestelhoeveelheid	Prijs/VE
223602467	GU5346C	carded	6	groen	1	12	2,70
223602475	GU5347C	carded	7	groen	1	12	2,70
223602483	GU5348C	carded	8	groen	1	12	2,70
223602491	GU5349C	carded	9	groen	1	12	2,70
223602509	GU53410C	carded	10	groen	1	12	2,70



Tuinhandschoen.
- Conform CE Cat. 1
- Naadloos, synthetisch
- PU handpalm
- Goede grip

Order nr.	223604091
Orig. nr.	GU55317C
Maat	7
VE	1
Min. bestelhoeveelheid	12
Prijs/VE	€ 1,80

Wegwerphandschoenen

GUIDE



Tuinhandschoen.
- Conform CE Cat. 1
- Naadloos, nylon
- PU handpalm
- Goede grip

Order nr.	223604133	223604141
Orig. nr.	GU55327C	GU55328C
Maat	7	8
VE	1	1
Min. bestelhoeveelheid	12	12
Prijs/VE	€ 4,00	4,00



GUIDE



JERSETTE. Sterke handschoen in blauwe latex.
-conform CE Cat.2 EN 388-3141, EN 407 X1XXXX, EN 374
-toepassing : landbouw-tuinbouw
-lengte 33cm, dikte 1.15mm
-zeer confortabel met zachte katoen binnenvoering

Order nr.	Orig. nr.	Maat	VE	Min. bestelhoeveelheid	Prijs/VE
642502058	GUMAP3016	6 - 6,5	1	5	10,00
642502066	GUMAP3017	7 - 7,5	1	5	10,00
642502074	GUMAP3018	8 - 8,5	1	5	10,00
642502082	GUMAP3019	9 - 9,5	1	5	10,00
642502090	GUMAP30110	10 - 10,5	1	5	10,00

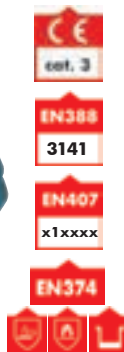

GUIDE



Gepoederde latex handschoenen.
-conform CE Cat.3, EN374, EN 455:1, EN455:2, EN455:3
-toepassing : huishoud-schilderwerken-voeding
-lengte 24cm
-opgerolde polsboord
-100 st.

Minimum besteleenheid : 5.

Order nr.	Orig. nr.	Maat	Prijs
223535675	GU601LA7	7	12,50
223535683	GU601LA8	8	12,50
223535691	GU601LA9	9	12,50
223535709	GU601LA10	10	12,50



GUIDE



Latex handschoenen-poedervrij.
-conform CE Cat.3, EN374, EN 455:1, EN455:2, EN455:3
-toepassing : huishoud-schilderwerken-voeding
-lengte 24cm, dikte : 0,11mm
-opgerolde polsboord
-100 st./doos

Minimum besteleenheid : 5.

Order nr.	Orig. nr.	Maat	VE	Min. bestelhoeveelheid	Prijs/VE
223535733	GU602LAPF7	7	1	5	13,50
223535741	GU602LAPF8	8	1	5	13,50
223535758	GU602LAPF9	9	1	5	13,50
223535766	GU602LAPF10	10	1	5	13,50



GUIDE



Gepoederde transparante vinyl handschoenen.
-conform CE Cat.1, EN455:1, EN455:2, EN455:3
-toepassing : huishoud-schilderwerken
-lengte 24cm
-opgerolde polsboord
-vinyl 100 st.

Minimum besteleenheid : 5.

Order nr.	Orig. nr.	Maat	VE	Min. bestelhoeveelheid	Prijs/VE
223535790	GU611VI7	7	1	5	7,90
223535808	GU611VI8	8	1	5	7,90
223535816	GU611VI9	9	1	5	7,90
223535824	GU611VI10	10	1	5	7,90



Veiligheidsschoenen



POLACCO

Hoge veiligheidsschoenen in hoogwaardig waterafstotend rundsnerf leder.

- veiligheidsklasse : S3
- kleur : zwart
- gewicht : 650gr
- schacht: vol nerfleder Burton
- buitenzool : dubbel densiteiten PU-zool
- binnenzool : anti-statisch en uitneembaar
- tussenzool : staal
- neus : staal
- overneus : pu

Order nr.	Orig. nr.	Maat	Prijs €
860000038	SHPOL38	38	51,90
860000039	SHPOL39	39	51,90
860000040	SHPOL40	40	51,90
860000041	SHPOL41	41	51,90
860000042	SHPOL42	42	51,90
860000043	SHPOL43	43	51,90
860000044	SHPOL44	44	51,90
860000045	SHPOL45	45	51,90
860000046	SHPOL46	46	51,90
860000047	SHPOL47	47	51,90

EQUIPMENT



FORCE

Sandaal Force 29018 S1P. Lage, open veiligheidsschoenen in suèdeleder

Veiligheidsklasse: S1P

Kleur: grijs

Gewicht: 600gr

Buitenzool: Dubbel densiteiten PU-zool

Binnenzool: antistatisch en uitneembaar

Tussenzool: metaal

Neus: staal

Order nr.	Orig. nr.	Maat	Prijs €
861001838	SHFO38	38	61,50
861001839	SHFO39	39	61,50
861001840	SHFO40	40	61,50
861001841	SHFO41	41	61,50
861001842	SHFO42	42	61,50
861001843	SHFO43	43	61,50
861001844	SHFO44	44	61,50
861001845	SHFO45	45	61,50
861001846	SHFO46	46	61,50
861001847	SHFO47	47	61,50





GIOVE S3

Lage veiligheidsschoen in waterafstotend buff burton.
 -veiligheidsklasse: S3
 -kleur: zwart
 -gewicht: 640gr
 -buitenzool: dubbele densiteit
 -PU-zoolbinnenzool: anti-statisch, anatomisch, uitneembaar
 -tussenzool: composit
 -neus: composit
 -voering: air mesh-ademend en vochtabsorberend

Order nr.	Orig. nr.	Maat	Prijs €
860001838	SHGIOL38	38	62,50
860001839	SHGIOL39	39	62,50
860001840	SHGIOL40	40	62,50
860001841	SHGIOL41	41	62,50
860001842	SHGIOL42	42	62,50
860001843	SHGIOL43	43	62,50
860001844	SHGIOL44	44	62,50
860001845	SHGIOL45	45	62,50
860001846	SHGIOL46	46	62,50
860001847	SHGIOL47	47	62,50



MERCURIO S3

Hoge veiligheidsschoen in waterafstotend buff burton.
 -veiligheidsklasse: S3
 -kleur: zwart
 -gewicht: 640gr
 -buitenzool: dubbele densiteit
 -PU-zoolbinnenzool: anti-statisch, anatomisch, uitneembaar
 -tussenzool: composit
 -neus: composit
 -voering: air mesh-ademend en vochtabsorberend

Order nr.	Orig. nr.	Maat	Prijs €
860001938	SHMER38	38	66,50
860001939	SHMER39	39	66,50
860001940	SHMER40	40	66,50
860001941	SHMER41	41	66,50
860001942	SHMER42	42	66,50
860001943	SHMER43	43	66,50
860001944	SHMER44	44	66,50
860001945	SHMER45	45	66,50
860001946	SHMER46	46	66,50
860001947	SHMER47	47	66,50



SH2109

Lage veiligheidsschoen in suèdeleder.
 -veiligheidsklasse: S1P
 -kleur: anthraciet-zwart
 -gewicht: 620gr
 -schacht: suèdeleder anthraciet – nylon zwart
 -buitenzool: dubbel densiteiten PU-zool
 -binnenzool: anti-statisch en uitneembaar
 -tussenzool: staal
 -neus: staal
 -voering: synthetic joe

Order nr.	Orig. nr.	Maat	Prijs €
860001340	SH210940	40	76,50
860001341	SH210941	41	76,50
860001342	SH210942	42	76,50
860001343	SH210943	43	76,50
860001344	SH210944	44	76,50
860001345	SH210945	45	76,50
860001346	SH210946	46	76,50
860001347	SH210947	47	76,50



SH2110

Hoge veiligheidsschoen in suèdeleder.
 -veiligheidsklasse: S1P
 -kleur: anthraciet-zwart
 -gewicht: 650gr
 -schacht: grijs suèdeleder - zwarte nylon
 -buitenzool: dubbel densiteiten PU-zool
 -binnenzool: anti-statisch en uitneembaar
 -tussenzool: staal
 -neus: staal
 -voering: synthetic joe

Order nr.	Orig. nr.	Maat	Prijs €
860001240	SH211040	40	79,50
860001241	SH211041	41	79,50
860001242	SH211042	42	79,50
860001243	SH211043	43	79,50
860001244	SH211044	44	79,50
860001245	SH211045	45	79,50
860001246	SH211046	46	79,50
860001247	SH211047	47	79,50

Voetbescherming



NEPTUN

Lage veiligheidsschoenen in gewaxt waterafstotend rundsnerf leder.-veiligheidsklasse : S3

- kleur : bruin
- gewicht : 620gr
- schacht: gewaxt rundsleer met reflecterende strips
- buitenzool : dubbel densiteiten PU-zool
- binnenzool : anti-statisch, anatomisch en uitneembaar
- tussenzool : composiet
- neus : staal
- overneus : pu
- voering : air mesh-ademend en vochtabsorberend
- hielversterking "torsion control"

Order nr.	Orig. nr.	Maat	Prijs €
860000438	SHNEPL38	38	88,00
860000439	SHNEPL39	39	88,00
860000440	SHNEPL40	40	88,00
860000441	SHNEPL41	41	88,00
860000442	SHNEPL42	42	88,00
860000443	SHNEPL43	43	88,00
860000444	SHNEPL44	44	88,00
860000445	SHNEPL45	45	88,00
860000446	SHNEPL46	46	88,00
860000447	SHNEPL47	47	88,00



SATURN

Hoge veiligheidsschoenen in gewaxt waterafstotend rundsnerf leder.-veiligheidsklasse : S3

- kleur : bruin
- gewicht : 680gr
- schacht: gewaxt rundsleer met reflecterende strips
- buitenzool : dubbel densiteiten PU-zool
- binnenzool : anti-statisch, anatomisch en uitneembaar
- tussenzool : staal
- neus : staal
- overneus : pu
- voering : air mesh-ademend en vochtabsorberend
- hielversterking "torsion control"

Order nr.	Orig. nr.	Maat	Prijs €
860000338	SHSATM38	38	94,50
860000339	SHSATM39	39	94,50
860000340	SHSATM40	40	94,50
860000341	SHSATM41	41	94,50
860000342	SHSATM42	42	94,50
860000343	SHSATM43	43	94,50
860000344	SHSATM44	44	94,50
860000345	SHSATM45	45	94,50
860000346	SHSATM46	46	94,50
860000347	SHSATM47	47	94,50
860000348	SHSATM48	48	94,50



ARIZONA WHITE S2

Lage veiligheidsschoenen in waterafstotend en ademendmicrovezel.-veiligheidsklasse : S2

- kleur : wit
- gewicht : 450gr
- schacht: waterafstotend en ademend microvezel
- buitenzool : enkel densiteiten PU-zool
- binnenzool : anti-statisch en uitneembaar
- neus : staal

Order nr.	Orig. nr.	Maat	Prijs €
860001035	SHARW35	35	50,90
860001036	SHARW36	36	50,90
860001037	SHARW37	37	50,90
860001038	SHARW38	38	50,90
860001039	SHARW39	39	50,90
860001040	SHARW40	40	50,90
860001041	SHARW41	41	50,90
860001042	SHARW42	42	50,90
860001043	SHARW43	43	50,90
860001044	SHARW44	44	50,90
860001045	SHARW45	45	50,90
860001046	SHARW46	46	50,90
860001047	SHARW47	47	50,90
860001048	SHARW48	48	50,90



ARIZONA BLACK S2

Lage veiligheidsschoenen in waterafstotend en ademend microvezel.-veiligheidsklasse : S2

- kleur : zwart
- gewicht : 450gr
- schacht: waterafstotend en ademend microvezel
- buitenzool : enkel densiteiten PU-zool
- binnenzool : anti-statisch en uitneembaar
- neus : staal

Order nr.	Orig. nr.	Maat	Prijs €
860001135	SHARB35	35	44,50
860001136	SHARB36	36	50,90
860001137	SHARB37	37	50,90
860001138	SHARB38	38	50,90
860001139	SHARB39	39	50,90
860001140	SHARB40	40	50,90
860001141	SHARB41	41	50,90
860001142	SHARB42	42	50,90
860001143	SHARB43	43	50,90
860001144	SHARB44	44	50,90
860001145	SHARB45	45	50,90
860001146	SHARB46	46	50,90
860001147	SHARB47	47	50,90
860001148	SHARB48	48	50,90



INTRODUCTION TO STANDARD PLUS LINE

Standard Plus line is a strong and aggressive line for tough workers who require extreme safety. Hard-wearing and stable shoes that do not compromise in terms of lightness and comfort.





WE MAKE GARMENTS THAT LET
YOU ADD A QUARTER OF AN
HOUR TO YOUR BREAK. THAT'S
CALLED EFFICIENCY.

You are probably best at carpentry, truck driving, bending pipes or connecting cables.

We are good at one thing: Work clothes That's all we know, but on the other hand, we are very good. Naturally we then aim to do everything we can to ensure you avoid thinking about your work clothes. We do it for you by developing solutions that make your work easier and more fun. If they also fit well, are nice and stylish, then we believe that you also work better. That is when we are really happy.

You only notice inferior work clothes. When they do not work. When they work as designed, you can devote yourself to what you do best, and do not need to think about your clothes at all. That's our job.

DESIGNED TO WORK



L. BRADOR®
DESIGNED TO WORK



Werkbroeken



Werkbroek 65% polyester, 35% katoen, 320g/m², grijs of bruin geruit:

- binnenzakken voor kniebeschermers 2 hoogtes
- 2 zijzakken
- 2 achterzakken
- 2 loshangende spijkerzakken
- 1 loshangende gsm zak
- rechterbeen : meterzak + pennezak + 2 hamerhouders
- linkerbeen : binnenzak, buitenzak, gsm zak, 2 pennezakken
- knieversterking in cordura
- onderkant versterkt met cordura.

Order nr.	Orig. nr.	Maat	Kleur	Prijs €
800013880	LBTR161BB44	44	zwart	89,50
800013898	LBTR161BB46	46	zwart	89,50
800013906	LBTR161BB48	48	zwart	89,50
800013914	LBTR161BB50	50	zwart	89,50
800013922	LBTR161BB52	52	zwart	89,50
800013930	LBTR161BB54	54	zwart	89,50
800013948	LBTR161BB56	56	zwart	89,50
800013955	LBTR161BB58	58	zwart	89,50
800013963	LBTR161BB60	60	zwart	89,50
800014011	LBTR161B148	148	zwart	89,50
207886847	LBTR161GY44	44	grijs	89,50
207886854	LBTR161GY46	46	grijs	89,50
207886862	LBTR161GY48	48	grijs	89,50
207886870	LBTR161GY50	50	grijs	89,50
207886888	LBTR161GY52	52	grijs	89,50
207886896	LBTR161GY54	54	grijs	89,50
207886904	LBTR161GY56	56	grijs	89,50
207886912	LBTR161GY58	58	grijs	89,50
207886920	LBTR161GY60	60	grijs	89,50
207886961	LBTR161GY146	146	grijs	89,50
207886979	LBTR161GY148	148	grijs	89,50
207886987	LBTR161GY150	150	grijs	89,50
207886995	LBTR161GY152	152	grijs	89,50



Werkbroek vervaardigd uit 65% polyester, 35% katoen, 320gr/m² :

- binnenzakken voor kniebeschermers 2 hoogtes
- 2 zijzakken
- 2 achterzakken
- rechterbeen : meterzak, pennezak, 2 hamerhouders
- linkerbeen : binnenzak + buitenzak, gsm zak, ID kaartzak, 2 pennezakken
- knieversterking in cordura
- onderkant versterkt met cordura.

Order nr.	Orig. nr.	Maat	Kleur	Prijs €
207701798	LBTR162N44	44	navy	74,50
207701806	LBTR162N46	46	navy	74,50
207701814	LBTR162N48	48	navy	74,50
207701822	LBTR162N50	50	navy	74,50
207701830	LBTR162N52	52	navy	74,50
207701848	LBTR162N54	54	navy	74,50
207701855	LBTR162N56	56	navy	74,50
207701863	LBTR162N58	58	navy	74,50
207701871	LBTR162N60	60	navy	74,50
207701913	LBTR162N146	146	navy	74,50
207701921	LBTR162N148	148	navy	74,50
207701939	LBTR162N150	150	navy	74,50
207701947	LBTR162N152	152	navy	74,50
207701954	LBTR162N154	154	navy	74,50
207701962	LBTR162N156	156	navy	74,50
207887969	LBTR162GY44	44	grijs	74,50
207887977	LBTR162GY46	46	grijs	74,50
207887985	LBTR162GY48	48	grijs	74,50
207887993	LBTR162GY50	50	grijs	74,50
207888009	LBTR162GY52	52	grijs	74,50
207888017	LBTR162GY54	54	grijs	74,50
207888025	LBTR162GY56	56	grijs	74,50
207888033	LBTR162GY58	58	grijs	74,50
207888041	LBTR162GY60	60	grijs	74,50
207888082	LBTR162GY146	146	grijs	74,50
207888090	LBTR162GY148	148	grijs	74,50
207888108	LBTR162GY150	150	grijs	74,50
207888116	LBTR162GY152	152	grijs	74,50
207888124	LBTR162GY154	154	grijs	74,50
207888132	LBTR162GY156	156	grijs	74,50
800014268	LBTR162BB44	44	zwart/zwart	74,50
800014276	LBTR162BB46	46	zwart/zwart	74,50
800014284	LBTR162BB48	48	zwart/zwart	74,50
800014292	LBTR162BB50	50	zwart/zwart	74,50
800014300	LBTR162BB52	52	zwart/zwart	74,50
800014318	LBTR162BB54	54	zwart/zwart	74,50
800014334	LBTR162BB58	58	zwart/zwart	74,50
800014326	LBTR162BB56	56	zwart/zwart	74,50



Order nr.	Orig. nr.	Maat	Kleur	Prijs €
800014342	LBTR162BB60	60	zwart/zwart	74,50
800001422	LBTR162CN44	44	navy geruit	74,50
800001430	LBTR162CN46	46	navy geruit	74,50
800001448	LBTR162CN48	48	navy geruit	74,50
800001455	LBTR162CN50	50	navy geruit	74,50
800001463	LBTR162CN52	52	navy geruit	74,50
800001471	LBTR162CN54	54	navy geruit	74,50
800001489	LBTR162CN56	56	navy geruit	74,50
800001497	LBTR162CN58	58	navy geruit	74,50
800001505	LBTR162CN60	60	navy geruit	74,50



Werkbroek, 65% polyester, 35% katoen, 300gr/m2.
 -2 zijzakken
 -2 achterzakken
 -rechterbeen : meterzak, pennezak, hamerhouder
 -linkerbeen : binnenzak + buitenzak, ID kaartzak, 2 gsm zakken, pennezak
 -onderkant versterkt met cordura
 -bijhorende werkvest : 172PB

Order nr.	Orig. nr.	Maat	Kleur	Prijs €
207892225	LBTR171GY44	44	grijs	72,00
207892233	LBTR171GY46	46	grijs	72,00
207892241	LBTR171GY48	48	grijs	72,00
207892258	LBTR171GY50	50	grijs	72,00
207892266	LBTR171GY52	52	grijs	72,00
207892274	LBTR171GY54	54	grijs	72,00
207892282	LBTR171GY56	56	grijs	72,00
207892290	LBTR171GY58	58	grijs	72,00
207892308	LBTR171GY60	60	grijs	72,00



Werkbroek. Met teflon behandeling. Bijhorende werkvest : 253PB.

Order nr.	Orig. nr.	Maat	Kleur	Prijs €
207891409	LBTR153B44	44	zwart	66,90
207891417	LBTR153B46	46	zwart	66,90
207891425	LBTR153B48	48	zwart	66,90
207891433	LBTR153B50	50	zwart	66,90
207891441	LBTR153B52	52	zwart	66,90
207891458	LBTR153B54	54	zwart	66,90
207891466	LBTR153B56	56	zwart	66,90
207891474	LBTR153B58	58	zwart	66,90
207891482	LBTR153B60	60	zwart	66,90
207891490	LBTR153GY44	44	grijs	66,90
207891508	LBTR153GY46	46	grijs	66,90
207891516	LBTR153GY48	48	grijs	66,90
207891524	LBTR153GY50	50	grijs	66,90
207891532	LBTR153GY52	52	grijs	66,90
207891540	LBTR153GY54	54	grijs	66,90
207891557	LBTR153GY56	56	grijs	66,90
207891565	LBTR153GY58	58	grijs	66,90
207891573	LBTR153GY60	60	grijs	66,90



Bretelbroek. 100% katoen. 375gr/m².
 - 2 richting rits.
 - 2 spijkerzakken versterkt met cordura.
 2 borstzakken, pennenzak, meshouder.
 2 achterzakken.

Beenzakken met klep, gsm zak, meterzak, pennenzak, 2 hamerhouders.
 Knieversterking en achterkant onderkant been versterkt met Cordura.

Binnenzakken voor kniebeschermers 2 hoogtes.
 - super sterke 3 dubbele naden

Order nr.	Orig. nr.	Maat	Kleur	Prijs €
810001917	LBSA181B4648	46/48	zwart	95,50
810001925	LBSA181B5052	50/52	zwart	95,50
810001933	LBSA181B5456	54/56	zwart	95,50
810001941	LBSA181B5860	58/60	zwart	95,50
810001958	LBSA181B6264	60/62	zwart	95,50



Werkshort, 100% katoen, 375gr/m² :
 -2 loshangende zakken versterkt met cordura
 -2 voorzakken
 -2 achterzakken waarvan 1 met klep
 -meterzak met regelbare meshouder, pennenzak
 -zakken voor gsm
 -2 hamerhouders.

Order nr.	Orig. nr.	Maat	Kleur	Prijs €
810003210	LBS111B44	44	zwart	66,50
810003228	LBS111B46	46	zwart	66,50
810003236	LBS111B48	48	zwart	66,50
810003244	LBS111B50	50	zwart	66,50
810003251	LBS111B52	52	zwart	66,50
810003269	LBS111B54	54	zwart	66,50
810003277	LBS111B56	56	zwart	66,50
810003285	LBS111B58	58	zwart	66,50
810003293	LBS111B60	60	zwart	66,50
810003335	LBS111N44	44	navy blauw	66,50
810003343	LBS111N46	46	navy blauw	66,50
810003350	LBS111N48	48	navy blauw	66,50
810003368	LBS111N50	50	navy blauw	66,50
810003376	LBS111N52	52	navy blauw	66,50
810003384	LBS111N54	54	navy blauw	66,50
810003392	LBS111N56	56	navy blauw	66,50
810003400	LBS111N58	58	navy blauw	66,50
810003418	LBS111N60	60	navy blauw	66,50
810004564	LBS111GY44	44	grijs	66,50
810004572	LBS111GY46	46	grijs	66,50
810004580	LBS111GY48	48	grijs	66,50
810004598	LBS111GY50	50	grijs	66,50
810004606	LBS111GY52	52	grijs	66,50
810004614	LBS111GY54	54	grijs	66,50
810004622	LBS111GY56	56	grijs	66,50
810004630	LBS111GY58	58	grijs	66,50
810004648	LBS111GY60	60	grijs	66,50



Werkbroek, 100% katoen, 375gr/m² : -binnenzakken voor kniebeschermers 2 hoogtes -2 zijzakken -2 achterzakken -2 loshangende spijkerzakken -1 loshangende gsm zak -rechterbeen : meterzak + pennenzak + 2 hamerhouders -linkerbeen : binnenzak, buitenzak, gsm zak, 2 pennenzakken -knieversterking in cordura -onderkant versterkt met cordura.

Order nr.	Orig. nr.	Maat	Kleur	Prijs €
810000778	LBTR101N44	44	navy	80,90
810000786	LBTR101N46	46	navy	80,90
810000794	LBTR101N48	48	navy	80,90
810000802	LBTR101N50	50	navy	80,90
810000810	LBTR101N52	52	navy	80,90
810000828	LBTR101N54	54	navy	80,90
810000836	LBTR101N56	56	navy	80,90
810000844	LBTR101N58	58	navy	80,90
810000851	LBTR101N60	60	navy	80,90

Overalls



Overall 195B, 100% katoen, 375gr/m2 :

- buitenzakken voor kniebeschermers
- verdoken 2 richting ritsluiting
- 1 borstzak met klep + velcro
- 1 borstzak met gsm zak en penzak
- 2 zijzakken -elastiek in de rug
- 2 achterzakken met plooi
- meterzak rechts
- gesloten mouwen met velcro
- 4 mogelijke kleuren

Order nr.	Orig. nr.	Maat	Kleur	Prijs €
810002063	LBOV195B44	44	zwart	99,50
810002071	LBOV195B46	46	zwart	99,50
810002089	LBOV195B48	48	zwart	99,50
810002097	LBOV195B50	50	zwart	99,50
810002105	LBOV195B52	52	zwart	99,50
810002113	LBOV195B54	54	zwart	99,50
810002121	LBOV195B56	56	zwart	99,50
810002139	LBOV195B58	58	zwart	99,50
810002147	LBOV195B60	60	zwart	99,50
810002154	LBOV195B62	62	zwart	99,50
810002188	LBOV195N44	44	navy	99,50
810002196	LBOV195N46	46	navy	99,50
810002204	LBOV195N48	48	navy	99,50
810002212	LBOV195N50	50	navy	99,50
810002220	LBOV195N52	52	navy	99,50
810002238	LBOV195N54	54	navy	99,50
810002246	LBOV195N56	56	navy	99,50
810002253	LBOV195N58	58	navy	99,50
810002261	LBOV195N60	60	navy	99,50
810002279	LBOV195N62	62	navy	99,50
810004887	LBOV195R44	44	royal	99,50
810004895	LBOV195R46	46	royal	99,50
810004903	LBOV195R48	48	royal	99,50
810004911	LBOV195R50	50	royal	99,50
810004929	LBOV195R52	52	royal	99,50
810004937	LBOV195R54	54	royal	99,50
810004945	LBOV195R56	56	royal	99,50
810004952	LBOV195R58	58	royal	99,50
810004960	LBOV195R60	60	royal	99,50
810004978	LBOV195R62	62	royal	99,50



Overall 197PB. 65% polyester, 35% katoen, 245 g/m2 :

- buitenzakken voor kniebeschermers
- verdoken 2 richting ritsluiting
- 2 borstzakken met klep + velcro
- 2 zijzakken
- elastiek in de rug
- 2 achterzakken met plooi
- gsm zak links
- meterzak rechts
- gesloten mouwen met drukknop
- 4 mogelijke kleuren

Order nr.	Orig. nr.	Maat	Kleur	Prijs €
800035123	LBOV197B44	44	zwart	103,00
800035131	LBOV197B46	46	zwart	103,00
800035149	LBOV197B48	48	zwart	103,00
800035156	LBOV197B50	50	zwart	103,00
800035164	LBOV197B52	52	zwart	103,00
800035172	LBOV197B54	54	zwart	103,00
800035180	LBOV197B56	56	zwart	103,00
800035198	LBOV197B58	58	zwart	103,00
800035206	LBOV197B60	60	zwart	103,00
800035214	LBOV197B62	62	zwart	103,00
800035222	LBOV197N44	44	navy	103,00
800035230	LBOV197N46	46	navy	103,00
800035248	LBOV197N48	48	navy	103,00
800035255	LBOV197N50	50	navy	103,00
800035263	LBOV197N52	52	navy	103,00
800035271	LBOV197N54	54	navy	103,00
800035289	LBOV197N56	56	navy	103,00
800035297	LBOV197N58	58	navy	103,00
800035305	LBOV197N60	60	navy	103,00
800035313	LBOV197N62	62	navy	103,00
800035321	LBOV197R44	44	royal	103,00
800035339	LBOV197R46	46	royal	103,00
800035347	LBOV197R48	48	royal	103,00
800035354	LBOV197R50	50	royal	103,00
800035362	LBOV197R52	52	royal	103,00
800035370	LBOV197R54	54	royal	103,00
800035388	LBOV197R56	56	royal	103,00
800035396	LBOV197R58	58	royal	103,00
800035404	LBOV197R60	60	royal	103,00
800035412	LBOV197R62	62	royal	103,00
800036188	LBOV197RE44	44	rood	103,00
800036196	LBOV197RE46	46	rood	103,00
800036204	LBOV197RE48	48	rood	103,00
800036212	LBOV197RE50	50	rood	103,00
800036220	LBOV197RE52	52	rood	103,00
800036238	LBOV197RE54	54	rood	103,00
800036246	LBOV197RE56	56	rood	103,00
800036253	LBOV197RE58	58	rood	103,00
800036261	LBOV197RE60	60	rood	103,00
800036279	LBOV197RE62	62	rood	103,00

EQUIPMENT



Wegweroverall polypropyleen:

- Conform Cat. 3, type 6
- Met ritssluiting en kap
- Comfortabel en ademend
- Elastiek aan polsen, kap, taille en enkels.
- Bescherming tegen stof, en vezels, o.a. asbest, spatten..
- Wit
- Van maat M tot XXL
- Individueel verpakt, karton van 25 stuks

Order nr.	Orig. nr.	Maat	VE	Min. bestelhoeveelheid	Prijs/VE
294500012	WWOVDWM	M	1	5	3,80
294500020	WWOVDWL	L	1	5	3,80
294500038	WWOVDWXL	XL	1	5	3,80
294500046	WWOVDWXXL	XXL	1	5	3,80



- Veiligheidsbroek 129PB. Hi-Viz geel/zwart of oranje/zwart, 80% polyester, 20% katoen, versterking in 100% cordura, 310 gr/m2, 3M reflectors. Conform EN471, klasse 2.
- water en olie bestendig
 - 2 zijzakken
 - 2 achterzakken waarvan 1 met klep + velcro
 - linkerbeen: gsm zak + binnenzak met klep
 - rechterbeen: meterzak

Order nr.	Orig. nr.	Maat	Kleur	Prijs
800043309	HIT129YC44	44	geel	89,90
800043317	HIT129YC46	46	geel	89,90
800043325	HIT129YC48	48	geel	89,90
800043333	HIT129YC50	50	geel	89,90
800043341	HIT129YC52	52	geel	89,90
800043358	HIT129YC54	54	geel	89,90
800043366	HIT129YC56	56	geel	89,90
800043374	HIT129YC58	58	geel	89,90
800045643	HIT129YD84	84	geel	89,90
800045650	HIT129YD88	88	geel	89,90
800045668	HIT129YD92	92	geel	89,90
800043390	HIT129YD96	96	geel	89,90
800043416	HIT129YD104	100	geel	89,90
800043416	HIT129YD104	100	geel	89,90
800043424	HIT129YD108	108	geel	89,90
800043432	HIT129YD112	112	geel	89,90
800043440	HIT129YD116	116	geel	89,90
800043457	HIT129OC44	44	oranje	89,90
800043465	HIT129OC46	46	oranje	89,90
800043473	HIT129OC48	48	oranje	89,90
800043481	HIT129OC50	50	oranje	89,90
800043499	HIT129OC52	52	oranje	89,90
800043507	HIT129OC54	54	oranje	89,90
800043515	HIT129OC56	56	oranje	89,90
800043523	HIT129OC58	58	oranje	89,90
800043531	HIT129OC60	60	oranje	89,90
800045676	HIT129OD84	84	oranje	89,90
800045684	HIT129OD88	88	oranje	89,90
800045692	HIT129OD92	92	oranje	89,90
800043549	HIT129OD96	96	oranje	89,90
800043556	HIT129OD100	100	oranje	89,90
800043564	HIT129OD104	104	oranje	89,90
800043572	HIT129OD108	108	oranje	89,90
800043580	HIT129OD112	112	oranje	89,90
800043598	HIT129OD116	116	oranje	89,90



Veiligheidsbroek 160PB. Hi-Viz geel/zwart of oranje/zwart, 80% polyester, 20% katoen, versterking in 100% cordura, 310 gr/m², 3M reflectors. Conform EN471, klasse 2.

-water en olie bestendig

-2 zijzakken

-2 achterzakken waarvan 1 met klep + velcro

-linkerbeen : gsm zak + binnenzak met klep

-rechterbeen : meterzak

Order nr.	Orig. nr.	Maat	Kleur	Prijs €
800043606	HIT160YC44	44	geel	104,90
800043614	HIT160YC46	46	geel	104,90
800043622	HIT160YC48	48	geel	104,90
800043630	HIT160YC50	50	geel	104,90
800043648	HIT160YC52	52	geel	104,90
800043655	HIT160YC54	54	geel	104,90
800043663	HIT160YC56	56	geel	104,90
800043671	HIT160YC58	58	geel	104,90
800043689	HIT160YC60	60	geel	104,90
800045700	HIT160YD84	84	geel	104,90
800045718	HIT160YD88	88	geel	104,90
800045726	HIT160YD92	92	geel	104,90
800043697	HIT160YD96	96	geel	104,90
800043705	HIT160YD100	100	geel	104,90
800043705	HIT160YD100	104	geel	104,90
800043721	HIT160YD108	108	geel	104,90
800043739	HIT160YD112	112	geel	104,90
800043747	HIT160YD116	116	geel	104,90
800043754	HIT160OC44	44	oranje	104,90
800043762	HIT160OC46	46	oranje	104,90
800043770	HIT160OC48	48	oranje	104,90
800043788	HIT160OC50	50	oranje	104,90
800043796	HIT160OC52	52	oranje	104,90
800043812	HIT160OC56	56	oranje	104,90
800043820	HIT160OC58	58	oranje	104,90
800043838	HIT160OC60	60	oranje	104,90
800045734	HIT160OD84	84	oranje	104,90
800045742	HIT160OD88	88	oranje	104,90
800045759	HIT160OD92	92	oranje	104,90
800043846	HIT160OD96	96	oranje	104,90
800043853	HIT160OD100	100	oranje	104,90
800043861	HIT160OD104	104	oranje	104,90
800043879	HIT160OD108	108	oranje	104,90
800043887	HIT160OD112	112	oranje	104,90
800043895	HIT160OD116	116	oranje	104,90



T-shirt. 100% polyester. 200gr/m². 3 M reflectoren. Geribde ronde nek in lycra.

Conform EN471, klasse 2.

Order nr.	Orig. nr.	Maat	Prijs €
207881038	HVTS284YS	S	29,50
207881046	HVTS284YM	M	29,50
207881053	HVTS284YL	L	29,50
207881061	HVTS284YXL	XL	29,50
207881079	HVTS284YXXL	XXL	29,50
207881178	HVTS284YXXXL	XXXL	29,50



Hi-vis polo. 100% polyester, coolmax. Geel of oranje. 185gr/m². 3M reflectoren. Conform EN471, klasse 2.

Order nr.	Orig. nr.	Maat	Kleur	Prijs €
800025678	HVPS406YXS	XS	geel	39,50
800025686	HVPS406YS	S	geel	39,50
800025694	HVPS406YM	M	geel	39,50
800025702	HVPS406YL	L	geel	39,50
800025710	HVPS406YXL	XL	geel	39,50
800025728	HVPS406YXXL	XXL	geel	39,50
800025736	HVPS406YXXXL	XXXL	geel	39,50
800025777	HVPS406ORXS	XS	oranje	39,50
800025785	HVPS406ORS	S	oranje	39,50
800025793	HVPS406ORM	M	oranje	39,50
800025801	HVPS406ORL	L	oranje	39,50
800025819	HVPS406ORXL	XL	oranje	39,50
800025827	HVPS406ORXXL	XXL	oranje	39,50
800025835	HVPS406ORXXXL	XXXL	oranje	39,50



Veiligheidssweater Hiviz - geel/zwart. Stretch tailleband, polsband en hals. 3M reflectors. 100% polyester, 240gr/m². Conform EN471 classe 1.

Order nr.	Orig. nr.	Maat	Prijs €
800009789	HISW285YBXS	XS	52,90
800009797	HISW285YBS	S	52,90
800009805	HISW285YBM	M	52,90
800009813	HISW285YBL	L	52,90
800009821	HISW285YBXL	XL	52,90
800009839	HISW285YBXXL	XXL	52,90
800009847	HISW285YBXXXL	XXXL	52,90



Veiligheidssweater Hiviz - oranje/zwart. Stretch tailleband, polsband en hals. 3M reflectors. 100% polyester, 240gr/m². Conform EN471 classe 1.

Order nr.	Orig. nr.	Maat	Prijs €
800009888	HISW285OBXS	XS	52,90
800009896	HISW285OBS	S	52,90
800009904	HISW285OBM	M	52,90
800009912	HISW285OBL	L	52,90
800009920	HISW285OBXL	XL	52,90
800009938	HISW285OBXXL	XXL	52,90
800009946	HISW285OBXXXL	XXXL	52,90



Fleece jacket oranje. Kan gebruikt worden met jas 420.

Order nr.	Orig. nr.	Maat	Prijs €
800011587	LBFJ421OXS	XS	63,50
800011595	LBFJ421OS	S	63,50
800011603	LBFJ421OM	M	63,50
800011611	LBFJ421OL	L	63,50
800011629	LBFJ421OXL	XL	63,50
800011637	LBFJ421O2XL	XXL	63,50
800011645	LBFJ421O3XL	XXXL	63,50



Fleece jacket geel. Kan gebruikt worden met jas 420.

Order nr.	Orig. nr.	Maat	Kleur	Prijs €
800011389	HUJ421YXS	XS	geel	63,50
800011397	HUJ421YS	S	geel	63,50
800011405	HUJ421YM	M	geel	63,50
800011413	HUJ421YL	L	geel	63,50
800011421	HUJ421YXL	XL	geel	63,50
800011439	HUJ421YX2XL	XXL	geel	63,50
800011447	HUJ421Y3XL	XXXL	geel	63,50



Veiligheidsvest Hi-Viz oranje, 91% polyester, 9% PU, 3M reflectors, voering in fleece. Water- en windproof. Ademend. Met ritssluiting. Conform EN471, klasse 3.

- 1 borstzak met ritssluiting
- 2 zijzakken met ritssluiting
- 3 binnenzakken waarvan 1 met ritssluiting
- verstelbare trekkoord langs onder
- gesloten mouwen met velcro.

Order nr.	Orig. nr.	Maat	Prijs €
207909268	HIJ289OXS	XS	95,50
207909276	HIJ289OS	S	95,50
207909284	HIJ289OM	M	95,50
207909292	HIJ289OL	L	95,50
207909300	HIJ289OXL	XL	95,50
207909318	HIJ289OXXL	XXL	95,50
207909326	HIJ289OXXXL	XXXL	95,50



Veiligheidsvest Hi-Viz geel, 91% polyester, 9% PU, 3M reflectors, voering in fleece. Water- en windproof. Ademend. Met ritssluiting. Conform EN471, klasse 3.

- 1 borstzak met ritssluiting
- 2 zijzakken met ritssluiting
- 3 binnenzakken waarvan 1 met ritssluiting
- verstelbare trekkoord langs onder
- gesloten mouwen met velcro.

Order nr.	Orig. nr.	Maat	Prijs €
207907320	HIJ289YXS	XS	95,50
207907338	HIJ289YS	S	95,50
207907346	HIJ289YM	M	95,50
207907353	HIJ289YL	L	95,50
207907361	HIJ289YXL	XL	95,50
207907379	HIJ289YXXL	XXL	95,50
207907387	HIJ289YXXXL	XXXL	95,50



L.Brador 208PB. Veiligheidsvest Hi-Viz geel of oranje. 325g/m². Water- en winddicht. ademend. Gevoerd. Conform EN471, klasse 2 (maten XS-M) of 3 (maten L-XXXL) en EN342.

- Met ritssluiting en verwijderbare kap.
- 2 borstzakken en 2 zijzakken met ritssluiting.
- Binnenzak en transparante binnenzak voor smartphone.

Order nr.	Orig. nr.	Maat	Kleur	Prijs €
800044869	HIJ208YXS	XS	geel	229,00
800044877	HIJ208YS	S	geel	229,00
800044885	HIJ210YM	M	geel	229,00
800044893	HIJ211YL	L	geel	229,00
800044901	HIJ212YXL	XL	geel	229,00
800044919	HIJ213YXXL	XXL	geel	229,00
800044927	HIJ214YXXXL	XXXL	geel	229,00
800044935	HIJ215YXXXXL	XXXXL	geel	229,00
800044943	HIJ216OXS	XS	oranje	229,00
800044950	HIJ217OS	S	oranje	229,00
800044968	HIJ218OM	M	oranje	229,00
800044976	HIJ219OL	L	oranje	229,00
800044984	HIJ220OXL	XL	oranje	229,00
800044992	HIJ221OXXL	XXL	oranje	229,00
800045007	HIJ222OXXXL	XXXL	oranje	229,00
800045015	HIJ223OXXXXL	XXXXL	geel	229,00



Hi-vis Regenjas. 55% polyester, 45% PU, 170gr/m², 3 M reflectoren.

- Polyurethaan gecoate polyester jersey
- Kap in kraag
- Met rits en drukknoepen
- 2 zijzakken met klep
- Geventileerde rug
- Gesloten mouwen met velcro
- Licht en plooibaar, comfortabel dankzij de stretch
- Genaaide en geplakte naden

Conform EN471, klasse 3, EN343.

Order nr.	Orig. nr.	Maat	Prijs €
800019739	LBRC903HIVISOXS	XS	74,00
800019747	LBRC903HIVISOS	S	74,00
800019754	LBRC903HIVISOM	M	74,00
800019762	LBRC903HIVISOL	L	74,00
800019770	LBRC903HIVISOXL	XL	74,00
800019788	LBRC903HIVISOXXL	XXL	74,00
800019796	LBRC903HIVISO3XL	3XL	74,00



Werk- & tooljassen



Bodywarmer. 100% polyester powerstretch. 200gr/m²
Met ritssluiting, oranje bies. 2 zijzakken.

Order nr.	Orig. nr.	Maat	Kleur	Prijs €
800016362	LBBW724PBXS	XS	zwart	54,90
800016370	LBBW724PBS	S	zwart	54,90
800016388	LBBW724PBM	M	zwart	54,90
800016396	LBBW724PBL	L	zwart	54,90
800016404	LBBW724PBXL	XL	zwart	54,90
800016412	LBBW724PBXXL	XXL	zwart	54,90
800016420	LBBW724PB3XL	XXXL	zwart	54,90
800016461	LBBW724PBD S	S	zwart dames	54,90
800016479	LBBW724PBD M	M	zwart dames	54,90
800016487	LBBW724PBD L	L	zwart dames	54,90
800016495	LBBW724PBD XL	XL	zwart dames	54,90
800016503	LBBW724PBD XXL	XXL	zwart dames	54,90

Softshells - fleeces



Jacket grijs of oranje. gemaakt uit 100% polyester, 360gr/m².

- ritssluiting
- 2 borstzakken met rits
- net voering
- met logo op linker mouw
- met duim opening.

Order nr.	Orig. nr.	Maat	Kleur	Prijs €
800005498	LBPJ548GYXS	XS	grijs	63,50
800005506	LBPJ548GYS	S	grijs	63,50
800005514	LBPJ548GYM	M	grijs	63,50
800005522	LBPJ548GYL	L	grijs	63,50
800005530	LBPJ548GYXL	XL	grijs	63,50
800005548	LBPJ548GYXXL	XXL	grijs	63,50
800005555	LBPJ548GYXXXL	XXXL	grijs	63,50



Softshell. 100% polyester powerstretch. 200gr/m²
2 zijzakken.

Order nr.	Orig. nr.	Maat	Kleur	Prijs €
800018947	LBSJ725GYXS	XS	grijs	65,90
800018954	LBSJ725GYS	S	grijs	65,90
800018962	LBSJ725GYM	M	grijs	65,90
800018970	LBSJ725GYL	L	grijs	65,90
800018988	LBSJ725GYXL	XL	grijs	65,90
800018996	LBSJ725GYXXL	XXL	grijs	65,90
800019002	LBSJ725GYXXXL	XXXL	grijs	65,90
800019044	LBSJ725GYDS	S	grijs dames	64,50
800019051	LBSJ725GYDM	M	grijs dames	64,50
800019069	LBSJ725GYDL	L	grijs dames	64,50
800019077	LBSJ725GYDXL	XL	grijs dames	64,50
800019085	LBSJ725GYDXXL	XXL	grijs dames	64,50
800019127	LBSJ725NXS	XS	navy	65,90
800019135	LBSJ725NS	S	navy	65,90
800019143	LBSJ725NM	M	navy	65,90
800019150	LBSJ725NL	L	navy	65,90
800019168	LBSJ725NXL	XL	navy	65,90
800019176	LBSJ725NXXL	XXL	navy	65,90
800019184	LBSJ725NXXXL	XXXL	navy	65,90
800019226	LBSJ725NDS	S	navy dames	64,50
800019234	LBSJ725NDM	M	navy dames	64,50
800019242	LBSJ725NDL	L	navy dames	64,50
800019259	LBSJ725NDXL	XL	navy dames	64,50
800019267	LBSJ725NDXXL	XXL	navy dames	64,50



Softshell. 100% polyester powerstretch. 200gr/m².
Met ritssluiting, oranje bias. Aansluitend model. 2 zijzakken.

Order nr.	Orig. nr.	Maat	Kleur	Prijs €
800016198	LBSJ723PBXS	XS	zwart	67,90
800016214	LBSJ723PBM	M	zwart	67,90
800016222	LBSJ723PBL	L	zwart	67,90
800016230	LBSJ723PBXL	XL	zwart	67,90
800016248	LBSJ723PBXXL	XXL	zwart	67,90
800016255	LBSJ723PB3XL	XXXL	zwart	67,90
800016297	LBSJ723PBDS	S	zwart dames	61,50
800016305	LBSJ723PBDM	M	zwart dames	61,50
800016313	LBSJ723PBDL	L	zwart dames	61,50

Order nr.	Orig. nr.	Maat	Kleur	Prijs €
800016321	LBSJ723PBDXL	XL	zwart dames	61,50
800016339	LBSJ723PBDXXL	XXL	zwart dames	61,50
800016867	LBSJ723LXS	XS	LIME	67,90
800016875	LBSJ723LIS	S	LIME	67,90
800016883	LBSJ723LIM	M	LIME	67,90
800016891	LBSJ723LIL	L	LIME	67,90
800016909	LBSJ723LIXL	XL	LIME	67,90
800016917	LBSJ723LIXXL	XXL	LIME	67,90
800016925	LBSJ723LIXXXL	XXXL	LIME	67,90
800016966	LBSJ723LIDS	S	LIME dames	67,90
800016974	LBSJ723LIDM	M	LIME dames	67,90
800016982	LBSJ723LIDL	L	LIME dames	67,90
800016990	LBSJ723LIDXL	XL	LIME dames	67,90
800017006	LBSJ723LIDXXL	XXL	LIME dames	67,90



SOFTSHELL jacket zwart in stretch materiaal, 96% polyester, 4% PU, 300gr/m² :

- wind- en waterafstotend
- ademend
- oranje voering in polar-fleece
- 2 zijzakken met ritssluiting
- 2 binnenzakken met ritssluiting
- verstelbare trekkoord langs onder
- gesloten mouwen met velcro.

Order nr.	Orig. nr.	Maat	Kleur	Prijs €
207905381	LBSJ554BXS	XS	zwart	70,00
207905399	LBSJ554BS	S	zwart	70,00
207905407	LBSJ554BM	M	zwart	70,00
207905415	LBSJ554BL	L	zwart	70,00
207905423	LBSJ554BXL	XL	zwart	70,00
207905431	LBSJ554BXXL	XXL	zwart	70,00
207905449	LBSJ554BXXXL	XXXL	zwart	70,00
207915687	LBSJ554BDS	S	zwart dames	70,00
207915695	LBSJ554BDM	M	zwart dames	70,00
207915703	LBSJ554BDL	L	zwart dames	70,00
207915711	LBSJ554BDXL	XL	zwart dames	70,00
207915729	LBSJ554BDXXL	XXL	zwart dames	70,00



Winterkledij



Winterjas. 100% polyester. Gewatteerde voering. 2 borstzakken met rits, 2 zijzakken met rits en fleece voering. 3 binnenzakken, waarvan 1 gsm zak. Geventileerde onderarmen. Verwijderbare kap. Kraag met fleece voering. Verstelbare trekkoord onderaan. Stretch polsband. Reflecterende banden. 2 richting ritssluiting.

Order nr.	Orig. nr.	Maat	Prijs €
800015901	LBWJ273PBXS	XS	106,00
800015919	LBWJ273PBS	S	106,00
800015927	LBWJ273BM	M	106,00
800015935	LBWJ273PBL	L	106,00
800015943	LBWJ273PBXL	XL	106,00
800015950	LBWJ273PBXXL	XXL	106,00
800015968	LBWJ273PBXXXL	XXXL	106,00



Winteroverall. 100% polyester, oxford. 210gr/m²
Water- en windproof
- Ademend
- vooraan en aan de buitenzijde van de benen 2-richting ritssluiting
- 2 borstzakken met velcro
- 2 zijzakken met ritssluiting, 2 achterzakken met kleppen, 2 binnenzakken waarvan 1 gsm zak.
- gesloten mouwen met velcro
Kraag met fleece voering.
Verwijderbare, gewatteerde kap (met rits).
Elastiek in rug en onderaan benen.
Nylon riem.
Reflectoren op kap, mouwen en benen, borst en rug.
Geplakte naden.

Order nr.	Orig. nr.	Maat	Kleur	Prijs €
800020877	LBOV531BROYXS	XS	zwart/blauw	150,00
800020901	LBOV531BROYL	L	zwart/blauw	150,00
800020919	LBOV531BROYXL	XL	zwart/blauw	150,00
800020927	LBOV531BROYXXL	XXL	zwart/blauw	150,00
800020935	LBOV531BROY3XL	XXXL	zwart/blauw	150,00
800020943	LBOV531BROY4XL	XXXXL	zwart/blauw	150,00

Regenkledij



Regenbroek groen 45% PU, 55% polyester. 170 gr/m². Met aanpasbare beenlengte. Elastische tailleband. Licht en plooibaar, comfortabel dankzij de stretch. Genaaide en geplakte naden. Conform EN343.

Order nr.	Orig. nr.	Maat	Prijs €
800020679	LBRT930GXS	XS	25,50
800020687	LBRT930GS	S	25,50
800020695	LBRT930GM	M	25,50
800020703	LBRT930GL	L	25,50
800020711	LBRT930GXL	XL	25,50
800020729	LBRT930GXXL	XXL	25,50
800020737	LBRT930GXXXL	XXXL	25,50



KORT

Regenjas groen, 45% PU, 55% polyester. 170gr/m². Met kap in kraag. Met ritssluiting en drukknopen. Lengte 82cm (maat L). Licht en plooibaar, comfortabel dankzij de stretch. Geventileerde rug. 2 zijzakken met klep en identiteitskaartszak onder de rechter klep. Verstelbare mouwen met drukknopen. Genaaide en geplakte naden. Conform EN343.

Order nr.	Orig. nr.	Maat	Prijs €
800020372	LBRC903GXS	XS	41,50
800020380	LBRC903GS	S	41,50
800020398	LBRC903GM	M	41,50
800020406	LBRC903GL	L	41,50
800020414	LBRC903GXL	XL	41,50
800020422	LBRC903GXXL	XXL	41,50
800020430	LBRC903GXXXL	XXXL	41,50



LANG

Regenjas, 45% PU, 55% polyester. 170gr/m². Met kap in kraag. Met ritssluiting en drukknoepen. Lengte 110cm (maat L). Licht en plooibaar, comfortabel dankzij de stretch. Geventileerde rug. 2 zijzakken met klep en identiteitskaartszak onder de rechter klep. Verstelbare mouwen met drukknoepen. Genaaide en geplakte naden. Conform EN343.

Order nr.	Orig. nr.	Maat	Kleur	Prijs €
800023442	LBRC904GXS	XS	groen	50,50
800023459	LBRC904GS	S	groen	50,50
800023467	LBRC904GM	M	groen	50,50
800023475	LBRC904GL	L	groen	50,50
800023483	LBRC904GXL	XL	groen	50,50
800023491	LBRC904GXXL	XXL	groen	50,50
800023509	LBRC904GXXXL	XXXL	groen	50,50

Sweaters



Sweater met kap en ritssluiting. 65% katoen, 35% polyester. 360gr/m². Logo op schouder en mouw. Gevoerde kap met trekkoord. 2 zakken. Stevige polsbanden.

Order nr.	Orig. nr.	Maat	Kleur	Prijs €
800024408	LBSW663GYXS	XS	grijs	55,50
800024416	LBSW663GYS	S	grijs	55,50
800024424	LBSW663GYM	M	grijs	55,50
800024432	LBSW663GYL	L	grijs	55,50
800024440	LBSW663GYXL	XL	grijs	55,50
800024457	LBSW663GYXXL	XXL	grijs	55,50
800024465	LBSW663GYXXXL	XXXL	grijs	55,50
800024507	LBSW663NXS	XS	navy	55,50
800024515	LBSW663NS	S	navy	55,50
800024523	LBSW663NM	M	navy	55,50
800024531	LBSW663NL	L	navy	55,50
800024549	LBSW663NXL	XL	navy	55,50
800024556	LBSW663NXXL	XXL	navy	55,50
800024564	LBSW663NXXXL	XXXL	navy	55,50



Sweater met kap. 60% katoen, 40% polyester. 300gr/m². Kangeroezak. Kap met trekkoord. Stretch tailleband en polsband.

Order nr.	Orig. nr.	Maat	Kleur	Prijs €
207914680	LBSW632BXS	XS	zwart	64,50
207914698	LBSW632BS	S	zwart	64,50
207914706	LBSW632BM	M	zwart	64,50
207914714	LBSW632BL	L	zwart	64,50
207914722	LBSW632BXL	XL	zwart	64,50
207914730	LBSW632BXXL	XXL	zwart	64,50
207914748	LBSW632BXXXL	XXXL	zwart	64,50



Sweater 60% katoen, 40% polyester. 300gr/m². V-hals met rits. Stretch tailleband en polsband.

Order nr.	Orig. nr.	Maat	Kleur	Prijs €
207918178	LBSW643BXS	XS	zwart	33,50
207918186	LBSW643BS	S	zwart	33,50
207918194	LBSW643BM	M	zwart	33,50
207918202	LBSW643BL	L	zwart	33,50
207918210	LBSW643BXL	XL	zwart	33,50
207918228	LBSW643BXXL	XXL	zwart	33,50
207918236	LBSW643BXXXL	XXXL	zwart	33,50
207918277	LBSW643NXS	XS	navy	33,50
207918285	LBSW643NS	S	navy	33,50
207918293	LBSW643NM	M	navy	33,50
207918301	LBSW643NL	L	navy	33,50
207918319	LBSW643NXL	XL	navy	33,50
207918327	LBSW643NXXL	XXL	navy	33,50
207918335	LBSW643NXXXL	XXXL	navy	33,50
800016644	LBSW643PBGYS	XS	grijs	33,50
800016651	LBSW643PBGYS	S	grijs	33,50
800016669	LBSW643PBGYM	M	grijs	33,50
800016677	LBSW643PBGYL	L	grijs	33,50
800016685	LBSW643PBGYXL	XL	grijs	33,50
800016693	LBSW643PBGYXXL	XXL	grijs	33,50
800016701	LBSW643PBGYXXXL	XXXL	grijs	33,50

Hemden



Hemd 100% katoen. 150gr/m². 2 borstzakken.

Order nr.	Orig. nr.	Maat	Kleur	Prijs €
207903832	LBSH606BWS	S	geruit	39,50
207903840	LBSH606BWM	M	geruit	39,50
207903857	LBSH606BWL	L	geruit	39,50
207903865	LBSH606BWXL	XL	geruit	39,50
207903873	LBSH606BWXXL	XXL	geruit	39,50
207903881	LBSH606BWXXXL	XXXL	geruit	39,50



Hemd 100% katoen. 190gr/m². 2 borstzakken. Metalen drukknoopen. Geschikt voor industriële was.

Order nr.	Orig. nr.	Maat	Kleur	Prijs €
800021883	LBSLS680BXS	XS	zwart	36,50
800021891	LBSLS680BS	S	zwart	36,50
800021909	LBSLS680BM	M	zwart	36,50
800021917	LBSLS680BL	L	zwart	36,50
800021925	LBSLS680BXL	XL	zwart	36,50
800021933	LBSLS680BXXL	XXL	zwart	36,50
800021941	LBSLS680BXXXL	XXXL	zwart	36,50
800021958	LBSLS680BXXXXL	XXXXL	zwart	36,50
800021990	LBSLS680NXS	XS	navy	36,50
800022006	LBSLS680NS	S	navy	36,50
800022014	LBSLS680NM	M	navy	36,50
800022022	LBSLS680NL	L	navy	36,50
800022030	LBSLS680NXL	XL	navy	36,50
800022048	LBSLS680NXXL	XXL	navy	36,50
800022055	LBSLS680NXXXL	XXXL	navy	36,50
800022063	LBSLS680NXXXXL	XXXXL	navy	36,50
800022105	LBSLS680GYXS	XS	grijs	36,50
800022113	LBSLS680GYS	S	grijs	36,50
800022121	LBSLS680GYM	M	grijs	36,50
800022139	LBSLS680GYL	L	grijs	36,50
800022147	LBSLS680GYXL	XL	grijs	36,50
800022154	LBSLS680GYXXL	XXL	grijs	36,50
800022162	LBSLS680GYXXXL	XXXL	grijs	36,50
800022170	LBSLS680GYXXXXL	XXXXL	grijs	36,50



Hemd 100% katoen. 190gr/m². 2 borstzakken. Metalen drukknoopen. Geschikt voor industriële was.

Order nr.	Orig. nr.	Maat	Kleur	Prijs €
800022212	LBSSS682BXS	XS	zwart	31,50
800022220	LBSSS682BS	S	zwart	31,50
800022238	LBSSS682BM	M	zwart	31,50
800022246	LBSSS682BL	L	zwart	31,50
800022261	LBSSS682BXL	XXL	zwart	31,50
800022279	LBSSS682BXXXL	XXXL	zwart	31,50
800022287	LBSSS682BXXXXL	XXXXL	zwart	31,50
800022329	LBSSS682NXS	XS	navy	31,50
800022337	LBSSS682NS	S	navy	31,50
800022345	LBSSS682NM	M	navy	31,50
800022352	LBSSS682NL	L	navy	31,50
800022360	LBSSS682NXL	XL	navy	31,50
800022378	LBSSS682NXXL	XXL	navy	31,50
800022386	LBSSS682NXXXL	XXXL	navy	31,50
800022394	LBSSS682NXXXXL	XXXXL	navy	31,50
800022436	LBSSS682GYXS	XS	grijs	31,50
800022444	LBSSS682GYS	S	grijs	31,50
800022451	LBSSS682GYM	M	grijs	31,50
800022469	LBSSS682GYL	L	grijs	31,50
800022477	LBSSS682GYXL	XL	grijs	31,50
800022485	LBSSS682GYXXL	XXL	grijs	31,50
800022493	LBSSS682GYXXXL	XXXL	grijs	31,50
800022501	LBSSS682GYXXXXL	XXXXL	grijs	31,50



GEVOERD

Hemd rits. Kleur: zwart/wit. 100% polyester, gewatteerde voering, 2 borstzakken, 2 zijzakken, 2 binnenzakken.

Order nr.	Orig. nr.	Maat	Prijs €
207913641	LBSH553BWXS	XS	44,50
207903733	LBSH553BWS	S	44,50
207903741	LBSH553BWM	M	44,50
207903758	LBSH553BWL	L	44,50
207903766	LBSH553BWXL	XL	44,50
207903774	LBSH553BWXXL	XXL	44,50
207913658	LBSH553BWXXXL	XXXL	44,50

T-shirts



T-shirt, 100% katoen, 190gr/m² :
-geribde ronde nek in lycra

Order nr.	Orig. nr.	Maat	Kleur	Prijs €
207904970	LBTS600NXS	XS	navy	12,50
207904988	LBTS600NS	S	navy	12,50
207904996	LBTS600NM	M	navy	12,50
207905001	LBTS600NL	L	navy	12,50
207905019	LBTS600NXL	XL	navy	12,50
207905027	LBTS600NXXL	XXL	navy	12,50
207905035	LBTS600NXXXL	XXXL	navy	12,50
207905050	LBTS600WXS	XS	wit	12,50
207905068	LBTS600WS	S	wit	12,50
207905076	LBTS600WM	M	wit	12,50
207905084	LBTS600WL	L	wit	12,50
207905092	LBTS600WXL	XL	wit	12,50
207905100	LBTS600WXXL	XXL	wit	12,50
207905118	LBTS600WXXXL	XXXL	wit	12,50
207905134	LBTS600ZXS	XS	zwart	12,50
207905142	LBTS600ZS	S	zwart	12,50
207905159	LBTS600ZM	M	zwart	12,50
207905167	LBTS600ZL	L	zwart	12,50
207905175	LBTS600ZXL	XL	zwart	12,50
207905183	LBTS600ZXXL	XXL	zwart	12,50
207905191	LBTS600ZXXXL	XXXL	zwart	12,50
207905217	LBTS600GYXS	XS	grijs	12,50
207905225	LBTS600GYS	S	grijs	12,50
207905233	LBTS600GYM	M	grijs	12,50
207905241	LBTS600GYL	L	grijs	12,50
207905258	LBTS600GYXL	XL	grijs	12,50
207905266	LBTS600GYXXL	XXL	grijs	12,50
207905274	LBTS600GYXXXL	XXXL	grijs	12,50



Polo in 100% katoen, 190gr/m². Korte mouwen.

Order nr.	Orig. nr.	Maat	Kleur	Prijs €
207915802	LBPO635BXS	XS	zwart	18,90
207915810	LBPO635BS	S	zwart	18,90
207915828	LBPO635BM	M	zwart	18,90
207915836	LBPO635BL	L	zwart	18,90
207915844	LBPO635BXL	XL	zwart	18,90
207915851	LBPO635BXXL	XXL	zwart	18,90
207915869	LBPO635BXXXL	XXXL	zwart	18,90
207916305	LBPO635BDS	S	zwart dames	18,90
207916313	LBPO635BDM	M	zwart dames	18,90
207916321	LBPO635BDL	L	zwart dames	18,90
207916339	LBPO635BDXL	XL	zwart dames	18,90
207916347	LBPO635BDXXL	XXL	zwart dames	18,90
207916008	LBPO635NXS	XS	navy	18,90
207916016	LBPO635NS	S	navy	18,90
207916024	LBPO635NM	M	navy	18,90
207916032	LBPO635NL	L	navy	18,90
207916040	LBPO635NXL	XL	navy	18,90
207916057	LBPO635NXXL	XXL	navy	18,90
207916065	LBPO635NXXXL	XXXL	navy	18,90

EQUIPMENT





Polo in 100% polyester. UV en anti-bacteriële bescherming. Droogt snel, ademend, optimale zweet afvoer. Licht en comfortabel. 180gr/m².

Order nr.	Orig. nr.	Maat	Kleur	Prijs €
207914789	LBPO619BGYXS	XS	zwart/grijs	23,90
207914797	LBPO619BGYS	S	zwart/grijs	23,90
207914805	LBPO619BGYM	M	zwart/grijs	23,90
207914813	LBPO619BGYL	L	zwart/grijs	23,90
207914821	LBPO619BGYXL	XL	zwart/grijs	23,90
207914839	LBPO619BGYXXL	XXL	zwart/grijs	23,90
207914847	LBPO619BGYXXXL	XXXL	zwart/grijs	23,90
207914888	LBPO619RWXS	XS	royal/wit	23,90
207914896	LBPO619RWS	S	royal/wit	23,90
207914904	LBPO619RWM	M	royal/wit	23,90
207914912	LBPO619RWL	L	royal/wit	23,90
207914920	LBPO619RWXL	XL	royal/wit	23,90
207914938	LBPO619RWXXL	XXL	royal/wit	23,90
207914946	LBPO619RWXXXL	XXXL	royal/wit	23,90
207914987	LBPO619WGYXS	XS	wit/grijs	23,90
207914995	LBPO619WGY S	S	wit/grijs	23,90
207915000	LBPO619WGYM	M	wit/grijs	23,90
207915018	LBPO619WGYL	L	wit/grijs	23,90
207915026	LBPO619WGYXL	XL	wit/grijs	23,90
207915034	LBPO619WGYXXL	XXL	wit/grijs	23,90
207915042	LBPO619WGYXXXL	XXXL	wit/grijs	23,90

Ondergoed



VLAMVERTRAGEND

Boxer short. 70% merino wol, 30% protex-M. 210gr/m² Vlamvertragend. In zachte en comfortabele merino wol.

Conform EN531, ENV 50354, Öko-tex 100.

Order nr.	Orig. nr.	Maat	Kleur	Prijs €
207913203	LBBX707BXS	XS	zwart	44,50
207913211	LBBX707BS	S	zwart	44,50
207913229	LBBX707BM	M	zwart	44,50
207913237	LBBX707BL	L	zwart	44,50
207913245	LBBX707BXL	XL	zwart	44,50
207913252	LBBX707BXXL	XXL	zwart	44,50
207913260	LBBX707BXXXL	XXXL	zwart	44,50



VLAMVERTRAGEND

Lange onderbroek. 70% merino wol, 30% protex-M. 210gr/m² vlamvertragend. In zachte en comfortabele merino wol.

Conform EN531, ENV 50354, Öko-tex 100.

Order nr.	Orig. nr.	Maat	Kleur	Prijs €
207913443	LBTO713BXS	XS	zwart	76,90
207913450	LBTO713BS	S	zwart	76,90
207913468	LBTO713BM	M	zwart	76,90
207913476	LBTO713BL	L	zwart	76,90
207913484	LBTO713BXL	XL	zwart	76,90
207913492	LBTO713BXXL	XXL	zwart	76,90
207913500	LBTO713BXXXL	XXXL	zwart	76,90



Lange onderbroek. 50% merino wol, 50% polyester. 230gr/m². Zachte en comfortabele merino wol. Binnenkant is polyester voor een goede vocht afvoer, buitenkant is wol voor een maximale warmte.

Conform öko-tex.

Order nr.	Orig. nr.	Maat	Kleur	Prijs €
800023640	LBTO712GYXS	XS	grijs	43,00
800023657	LBTO712GYS	S	grijs	43,00
800023665	LBTO712GYM	M	grijs	43,00
800023673	LBTO712GYL	L	grijs	43,00
800023681	LBTO712GYXL	XL	grijs	43,00
800023699	LBTO712GY2XL	XXL	grijs	43,00
800023707	LBTO712GY3XL	XXXL	grijs	43,00



T-shirt, lange mouwen. 50% merino wol, 50% polyester. 230gr/m².

Zachte en comfortabele merino wol. Binnenkant is polyester voor een goede vocht afvoer, buitenkant is wol voor een maximale warmte.

Conform öko-tex.

Order nr.	Orig. nr.	Maat	Kleur	Prijs €
800023848	LBTS717GYXS	XS	grijs	51,90
800023855	LBTS717GYS	S	grijs	51,90
800023863	LBTS717GYM	M	grijs	51,90
800023871	LBTS717GYL	L	grijs	51,90
800023889	LBTS717GYXL	XL	grijs	51,90
800023897	LBTS717GY2XL	XXL	grijs	51,90
800023905	LBTS717GY3XL	XXXL	grijs	51,90



VLAMVERTRAGEND

Sweater. 70% merino wol, 30% protex-M. 210gr/m². Vlamvertragend. In zachte en comfortabele merino wol.

Conform EN531, ENV 50354, Öko-tex 100.

Order nr.	Orig. nr.	Maat	Kleur	Prijs €
207913104	LBTO706BXS	XS	zwart	85,50
207913112	LBTO706BS	S	zwart	85,50
207913120	LBTO706BM	M	zwart	85,50
207913138	LBTO706BL	L	zwart	85,50
207913146	LBTO706BXL	XL	zwart	85,50
207913153	LBTO706BXXL	XXL	zwart	85,50
207913161	LBTO706BXXXL	XXXL	zwart	85,50



VLAMVERTRAGEND

T-shirt. 70% merino wol, 30% protex-M. 210gr/m². Vlamvertragend. In zachte en comfortabele merino wol.

Conform EN531, ENV 50354, Öko-tex 100.

Order nr.	Orig. nr.	Maat	Kleur	Prijs €
207913302	LBTO708BXS	XS	zwart	74,50
207913310	LBTO708BS	S	zwart	74,50
207913328	LBTO708BM	M	zwart	74,50
207913336	LBTO708BL	L	zwart	74,50
207913344	LBTO708BXL	XL	zwart	74,50
207913351	LBTO708BXXL	XXL	zwart	74,50
207913369	LBTO708BXXXL	XXXL	zwart	74,50

Riemen



Riem zwart 120cm, polyester en rubber, elastisch, met metalen buckle.

Order nr.	207907403	207907411
Orig. nr.	LBB577B	207907411
Kleur	zwart	gestreept
Prijs	€ 7,40	6,70



Riem in polyester en rubber. Zwart. Rubberen buckle. Velcro bevestiging. 120 cm.

Order nr.	800012783
Orig. nr.	LBB594B
Kleur	zwart met rubberen bekle met velcro
VE	1
Min. bestelhoeveelheid	5
Prijs/VE	€ 12,50

Rug- & polsbescherming



Adapt comfort POLS-EN DUIMBAND. Elastische pols-en duimband met velcro sluiting.
 -verhoogt plaatselijk de lichaamswarmte met 2°C en verhoogt de bloedstroom zodat de pijn wordt verlicht en tegelijkertijd het helingsproces wordt versneld
 -universele maat
 -gebruik tegen polspijn-tendinitis
 -samenstelling : neoprene met stoffen voering (zweetafvoerend)

Order nr.	013220777
Orig. nr.	SKYPOLS
Prijs	€ 31,50



TURBO FIX 844 LENDENBAND. Vaste lendenband met velcro sluiting.
 -gebruik boven de kledij
 -preventie en behandeling tegen lage rugpijnen
 -samenstelling : 70% rubber-30%polyester

Order nr.	850003008	850003009
Orig. nr.	JOLB844XL	JOLB844XXL
Maat	XL	XXL
Prijs	€ 10,50	10,50

Kniebescherming



Knie beschermers grijs.

Order nr.	207887621
Orig. nr.	LBK571G
Prijs	€ 12,50



TUIN. Rubberen kniebeschermer in zwart.
 -standaard model met elastische riem
 -voor tuinwerk

Order nr.	207902669
Orig. nr.	207902669
Gewicht	kg 0,30
Prijs	€ 15,50



Brandbescherming



VLAMVERTRAGEND

- Vlamvertragende vest.
- 100% katoen met Proban behandeling: deze beperkt de vlamverspreiding
- De vlamvertragende eigenschappen gaan niet verloren bij het wassen
- EN 531 (A, B1, C1)
- 350gr/m²
- 2 zijzakken, 2 borstzakken, 2 binnenzakken waarvan 1 telefoonzak
- Reflectors op schouders en armen
- Mouwvernaauwing dmv drukknopen en aan taille

Order nr.	Orig. nr.	Maat	Prijs €
800005969	LBJF322OXS	XS	87,90
800005977	LBJF322OS	S	87,90
800005985	LBJF322OM	M	87,90
800005993	LBJF322OL	L	87,90
800006009	LBJF322OXL	XL	87,90
800006017	LBJF322OXXL	XXL	87,90
800006025	LBJF322OXXXL	XXXL	87,90



VLAMVERTRAGEND

- Vlamvertragende broek.
- 100% katoen met Proban behandeling
- EN 531 (A, B1, C1)
- 350gr/m²
- 2 zijzakken, 2 achterzakken, 1 beenzak met ID kaart zak en GSM zak
- Reflectors onderaan benen

Order nr.	Orig. nr.	Maat	Prijs €
800005803	LBTRF302O44	44	73,90
800005811	LBTRF302O46	46	73,90
800005829	LBTRF302O48	48	73,90
800005837	LBTRF302O50	50	73,90
800005845	LBTRF302O52	52	73,90
800005852	LBTRF302O54	54	73,90
800005860	LBTRF302O56	56	73,90
800005878	LBTRF302O58	58	73,90
800005886	LBTRF302O60	60	73,90
800005894	LBTRF302O62	62	73,90
800005902	LBTRF302O64	64	73,90
800005910	LBTRF302O66	66	73,90
800005928	LBTRF302O68	68	73,90

Valbescherming



Valbeveiligingskit.

CRAC2 : Ideaal voor dakwerken. Bestaande uit harnasgordel (1123), rugzak (9447), ankerpuntband 1m (9284), lijnklem op touw 15m (1222).

CRAC3 : Ideaal voor gebruik in een ramenwasserslift. Bestaande uit : harnasgordel (1111), rugzak (9447), ankerpuntband 1m (9284), oprolsysteem 1,7m (5001).

Order nr.	012220018	012220026
Orig. nr.	CRAC2	CRAC3
Gewicht	kg 2,70	2,20
Prijs	€ 725,00	539,00



EQUIPMENT



Positioneringsharnas met Hiviz vest. 2 zakken. Bevestigingspunten op borst en rug. Met lendenband. Snelsluiting. EN 361.

Order nr.	012201315	012201323
Orig. nr.	CR1144L	CR1144XL
Maat	L	XL
Gewicht	kg 1,93	2,03
Prijs	€ 386,00	386,00



Universele valbeveiligingsharnasgordel.

CR1112 : Bevestigingspunten op borst en rug. Eenvoudig verstelbaar EN 361.

CR1123 : Bevestigingspunten op rug en borst (op lendenhoogte, om vrij te kunnen bewegen). Lendenband. Gepolsterde rug en schouders. Snelsluiting. EN 361.

CR1122 : Bevestigingspunten op borst en rug. Lendenband. Gepolsterde rug en schouders. Snelsluiting. EN 361, EN 358.

Order nr.	012200028	012200127	012200135
Orig. nr.	CR1112	CR1122	CR1123
Gewicht	kg 1,04	1,90	1,40
Prijs	€ 152,00	396,00	290,00



CRESTO[®]

Platformwagens

METALWORKS



Platformwagen. Laadblad in geperste staalplaat met kunststof beschermingslaag. Zacht-vinyl beschermingsboord rondom het laadplatform. Met 2 vaste en 2 draaibare harde rubber wielen. Neerklapbare hendel voor een compact opbergen van de platformwagens.

Order nr.	758621500 €	758623000 €
Orig. nr.	SHC150	SHC300
Capaciteit	kg 150	300
Diameter banden	mm 100	120
Afmetingen laadvlak	mm 740x480	920x610
Hoogte	mm 840	840
Gewicht	kg 20,00	25,00
Prijs	€ 29,00	49,90

METALWORKS



Platformwagen. Laadblad in geperste staalplaat met kunststof beschermingslaag. Zacht-vinyl beschermingsboord rondom het laadplatform. Met 2 vaste en 2 draaibare luchtbanden. Neerklapbare hendel voor een compact opbergen van de platformwagens.

Order nr.	758623100 €
Orig. nr.	SHC300A
Capaciteit	kg 300
Diameter banden	mm 200
Afmetingen laadvlak	mm 920x610
Hoogte	mm 850
Gewicht	kg 29,00
Prijs	€ 77,00

METALWORKS



Platformwagen. Kunststof laadblad. Heel licht en supersterk. Met 2 vaste en 2 draaibare wielen. Grote, geruisloze PU wielen. Neerklapbare hendel voor een compact opbergen van de platformwagens.

Order nr.	758621240 €
Orig. nr.	SHC400K
Capaciteit	kg 400
Diameter banden	mm 150
Afmetingen laadvlak	mm 910x600
Gewicht	kg 20,00
Prijs	€ 102,00

Steekwagens

METALWORKS



Steekwagen. Op slijtvaste en geluiddempende polyurethaanwielen diam. 260 mm op rollagers. SHC01250. Gelaste stalen buisconstructie. SHC01250A. Gelaste aluminium buisconstructie.

Order nr.	758621250 €	758621255 €
Orig. nr.	SHC01250	SHC01250A
Capaciteit	kg 250	250
Afmetingen tafel	mm 400x180	400x200
Afmetingen buizen	mm 25x1,5	25x1,5
Diameter banden	mm 260	260
Materie	staal	alu
Gewicht	kg 10,50	62,00
Afmetingen (l x b x h)	mm 500 x 470 x 1150	500 x 470 x 1150
Prijs	€ 69,00	99,00

METALWORKS



Steekwagen. Op slijtvaste en geluiddempende polyurethaanwielen diam. 260 mm op rollagers. SHC04250. TYPE HIGH. Gelaste stalen buisconstructie. SHC04250A. TYPE HIGH ALU. Gelaste aluminium buisconstructie.

Order nr.	758624250 €	758624255 €
Orig. nr.	SHC04250	SHC04250A
Capaciteit	kg 250	250
Afmetingen tafel	mm 270x200	270x200
Afmetingen buizen	mm 25x1,5	25x1,5
Diameter banden	mm 260	260
Materie	staal	alu
Gewicht	kg 14,00	7,60
Afmetingen (l x b x h)	mm 450 x 500 x 1160	450 x 500 x 1160
Prijs	€ 74,00	107,00

METALWORKS



Steekwagen. TYPE BIG BOX. Gelaste stalen buisconstructie. Op slijtvaste en geluiddempende polyurethaan-wielen diam. 260 mm op rollagers. Met neerklapbare lange voet om groot-volume lasten te kunnen vervoeren bvb. witgoed.

Order nr.	758622612 €	
Orig. nr.	SHCA260	
Capaciteit	kg	150
Afmetingen tafel	mm	400x500
Afmetingen buizen	mm	25x1,5
Diameter banden	mm	260
Materie	staal	
Gewicht	kg	10,00
Afmetingen (l x b x h)	mm	540 x 600 x 1250
Prijs	€	111,00

METALWORKS



Steekwagen TYPE BIG BOX TRAP. Gelaste stalen buisconstructie. Op 2x3 volle rubberwielen diam. 150 mm voor het transporteren op trappen. Met neerklapbare lange voet om groot-volume te kunnen vervoeren.

Order nr.	758624151 €	
Orig. nr.	SHC410	
Capaciteit	kg	200
Afmetingen tafel	mm	400x500
Afmetingen buizen	mm	25x1,5
Diameter banden	mm	150
Materie	staal	
Gewicht	kg	17,50
Afmetingen (l x b x h)	mm	540 x 600 x 1250
Prijs	€	147,00

METALWORKS



Zware steekwagen TYPE GASFLES. Gelaste stalen buisconstructie. Op luchtbanden diam. 260 mm op rollagers. Met opbergvak. Voor het transport van 2 standaard gasflessen.

Order nr.	758625610 €	
Orig. nr.	SHC561	
Capaciteit	kg	200
Afmetingen tafel	mm	490x250
Afmetingen buizen	mm	25x2
Diameter banden	mm	260
Materie	staal	
Gewicht	kg	18,50
Afmetingen (l x b x h)	mm	700 x 680 x 1100
Prijs	€	154,00

METALWORKS



Steekwagen TYPE HEAVY DUTY. Gelaste stalen buisconstructie. Op volle rubberwielen diam. 200mm.

Order nr.	758625612 €	
Orig. nr.	SHC530	
Capaciteit	kg	300
Afmetingen tafel	mm	390x210
Afmetingen buizen	mm	25x1,5
Diameter banden	mm	200
Materie	staal	
Gewicht	kg	15,80
Afmetingen (l x b x h)	mm	550 x 660 x 1130
Prijs	€	90,00

EQUIPMENT



Transpalletwagens



Professionele transpallet met 2T of 2,5T hefkraft. Stabiele en robuuste kwaliteit voor dagelijks gebruik. Volhydraulische hef- en daalinrichting. Pomp met hardverchromde zuiger en overdrukventiel. Daalsnelheid traploos regelbaar via een fijnvoelig aflaatsventiel. Chassis en vorken zeer stabiel. 3 functies via een hendel (heffen, dalen, neutrale positie). Het bereiken van de maximale hoogte in slechts 10 slagen. Zeer wendbaar door een hoge draaislag tot 210°. Gemakkelijk verrolbaar door extra lichte aluminiumwielen met rubber en tandem vorkwielen in PU. Onderhoudsvrij. Gebouwd volgens CE-normen.

Order nr.	716150200	716150255
Orig. nr.	PHW2000	PHW2505
Capaciteit	T 2,0	2,5
Breedte vork	mm 150	160
Totale breedte	mm 520	540
Minimum vorkhoogte	mm 75	85
Hefhoogte	mm 115	200
Lengte vorken	mm 1150	1150
Gewicht	kg 55,00	84,00
Prijs	€ 344,00	411,00



Transpalletwagen - EXTRA LAAG MODEL capaciteit 2,5T. De vorken zijn 20mm lager dan een normale transpallet. Industriële kwaliteit. Pomp met kwaliteits-hydrauliek. Euro-pallet type. Met enkelvoudige topwielen. Veiligheidshandvat met 3 functie-posities. Voorzien van smerpunten. Voor wie geregeld lagere niet-standaard palletten dient te vervoeren.

Order nr.	758702551
Orig. nr.	TPCBY25TSL
Capaciteit	T 2,5
Lengte vorken	mm 1150
Hoogte vorken	mm 71
Topwielen	mm 2x1
Breedte vorken - overmeten	mm 510
Breedte vorken - tussenruimte	mm 220
Gewicht	kg 130,00
Prijs	€ 411,00



Professionele korte transpallet met 2,5T hefkraft. Stabiele en robuuste kwaliteit voor dagelijks gebruik. Volhydraulische hef- en daalinrichting. Pomp met hardverchromde zuiger en overdrukventiel. Daalsnelheid traploos regelbaar. Chassis en vorken zeer stabiel. 3 el. 3 functies via een hendel bedienbaar (heffen, dalen, neutrale positie). Het bereiken van de maximale hoogte in slechts 10 slagen. Zeer wendbaar door een hoge draaislag tot 210°. Gemakkelijk verrolbaar door extra lichte aluminiumwielen met rubber en tandem vorkwielen in PU. Onderhoudsvrij. Gebouwd volgens CE-normen.

Order nr.	716150256
Orig. nr.	PHW2505K
Capaciteit	T 2,5
Lengte extra korte vorken	mm 800
Breedte vork	mm 160
Totale breedte	mm 540
Minimum vorkhoogte	mm 85
Hefhoogte	mm 200
Totale lengte	mm 1170
Gewicht	kg 71,00
Prijs	€ 489,00



Gecombineerde transpalletwagen - schaarlift met capaciteit 1 ton. Pomp met kwaliteits-hydrauliek met hardverchromde stang en overbelastingsventiel. Daalsnelheid regelbaar. Mechanische snelgang maakt het mogelijk om de 800mm pallethoogte in 25 bewegingen te bereiken. Zeer wendbaar dankzij de draaihoek tot 210°. Bij het omhoogpompen zetten de 2 alu-steunen zich op grond en garanderen zo de stabiliteit.

Order nr.	758710001
Orig. nr.	PHH1001
Capaciteit	T 1
Breedte vork	mm 160
Totale breedte	mm 540
Minimum vorkhoogte	mm 85
Hefhoogte	mm 715
Lengte vorken	mm 1150
Chassishoogte	mm 430
Gewicht	kg 110,00
Prijs	€ 745,00

Unicraft



Transpalletwagen 2 ton met weegschaal. Groot LCD-display met goede leesbaarheid. Nauwkeurigheid 0,1%. Functies: tara-correctie, bruto/netto gewicht en sommeringsfunctie. Werkt op batterijen. Daalsnelheid met hendel regelbaar. Met neutrale veiligheidspositie.

Order nr.	716150262 E		
Orig. nr.		PHW2002W	
Capaciteit	T	2	
Breedte vork	mm	182	
Totale breedte	mm	572	
Minimum vorkhoogte	mm	85	
Helhoogte	mm	200	
Lengte vorken	mm	1150	
Gewicht	kg	130,00	
Prijs	€	1.499,00	

Unicraft



Transpallet-stopper. Voorkomt weggrollen van transpallets, heftrucks, ... Vervaardigd uit schokbestendige harde PVC, met handvat. Geschikt voor alle types van palletwagens.

Order nr.	716150001 E		
Orig. nr.		PHS1	
Gewicht	kg	1,47	
Afmetingen (l x b x h)	mm	295 x 290 x 50	
Prijs	€	26,00	

Transportrollen

Unicraft



Complete transportrollenset voor het verplaatsen van zware lasten. Inhoud: 4 transportrollen, 2 draaibare ronde draagplaten, 2 hoekige draagplaten, 2 verbindingstangen, 2 stuurbaren, 1 trekstang en 1 metalen opbergkoffer met wielen en handvaten.

Order nr.	716195020 E		
Orig. nr.		TR20	
Capaciteit	T	20	
Hoogte	mm	108	
Gewicht	kg	50,00	
Prijs	€	549,00	

Unicraft



Set transportrollen voor gemakkelijk verhuizen van zware lasten. Kogelgelagerde Nylonrollen, met anti-slip gummilaag bovenaan. Inhoud: 2 per set, inclusief 2 stangen van 500mm om ze te verbinden.

Order nr.	716192060 E		716192120 E	
Orig. nr.		VTR6	VTR12	
Capaciteit	T	6	12	
Gewicht	kg	30,00	38,00	
Afmetingen (l x b x h)	mm	320 x 290 x 110	420 x 270 x 110	
Prijs	€	242,00	336,00	

Unicraft



Transportplaat met handvat. Met draaibaar plateau voor gemakkelijk verhuizen van zware lasten. Kogelgelagerde Nylonrollen, en anti-slip gummilaagbovenaan. Wordt gebruikt samen met VTR-set rollen.

Order nr.	716191030 E		716191060 E		716191120 E	
Orig. nr.		TF3	TF6		TF12	
Capaciteit	T	3	6		12	
Gewicht	kg	15,00	50,00		66,00	
Afmetingen (l x b x h)	mm	300 x 220 x 105	640 x 530 x 115		640 x 560 x 115	
Prijs	€	144,00	344,00		414,00	

Unicraft



Massieve stalen hefstang met rollen voor hoge stabiliteit. Voor het optillen van zware lasten of machines.

Order nr.	716196015 E		716196050 E	
Orig. nr.		HS1.5	HS5	
Capaciteit	T	1,5	5	
Lengte	mm	2000	2200	
Gewicht	kg	16,00	32,00	
Prijs	€	95,00	199,00	

Unitcraft



Verhuizer voor het verplaatsen van voertuigen, ideaal voor krappe ruimten, garages of depots. Zijwaarts en ter plekke draaien mogelijk. Lichte behuizing. Geschikt voor wiel diameter vanaf 30 cm.

Order nr.	716201600 €	
Orig. nr.		PV680
Capaciteit	kg	680
Maximum wiel diameter	mm	300
Gewicht	kg	21,50
Afmetingen (l x b x h)	mm	68 x 65 x 22
Prijs	€	163,00

Unitcraft



Transporthoekrollen voor het verhuizen van kasten en hoekige meubels. Geleverd per set van 4 hoeken.

Order nr.	716197150 €	
Orig. nr.		ETR4/150
Capaciteit	kg	150
Gewicht	kg	8,00
Afmetingen (l x b x h)	mm	255 x 255 x 85
Prijs	€	134,00

Unitcraft



Mobiele basis voor het verplaatsen van machines. Gemakkelijk opkrikken en verrijden. Eenvoudig aanpasbaar. Met 360° draaibare wielen met rem. Capaciteit 230 kg.

Order nr.	716150230 €	
Orig. nr.		UF230
Minimum grootte vierkant	mm	280x280
Maximum grootte vierkant	mm	890x890
Minimum grootte rechthoekig	mm	430x280
Maximum grootte rechthoekig	mm	1290x480
Afstand tussen openingen	mm	25
Capaciteit	kg	230
Materie		staal
Gewicht	kg	7,62
Prijs	€	82,50

Unitcraft



Set hefroller 1 ton.- Voor het verplaatsen van zware lasten, dozen, kasten, kisten, ...

- Set van 2 hefrollers met hefstang
- Capaciteit 1 ton per set.
- Verzinks stalen frame met gummi beschermlaag en krasvrije PU wielen

Order nr.	716191000 €	
Orig. nr.		6191000
Capaciteit	kg	1000
Gewicht	kg	10,00
Prijs	€	123,00

Unitcraft



Hydraulische machinekriks. Voor het veilig heffen en ondersteunen van diverse lasten. Stabiele gelaste constructie voor zware belasting. Lage minimumhoogte ideaal voor kisten, machines, ... 360° Draaibare pompeenheid voor gemakkelijk positioneren (HMH 5 / HMH 10). Met wielbasis (HMH 25). Hendel afneembaar.

Order nr.	716190050	716190100	716190250
	€	€	€
Orig. nr.	HMH5	HMH10	HMH25
Capaciteit	T 5	10	25
Hoogte minimum	mm 25	30	58
Hefhoogte	mm 205	230	215
Gewicht	kg 25,00	35,00	102,00
Afmetingen (l x b x h)	mm 360 x 190 x 430	380 x 220 x 510	530 x 350 x 610
Prijs	€ 285,00	349,00	1.199,00

Unitcraft



Machinekriks met hoge capaciteit voor het optillen van machines, kratten, werkstukken ...

- Stabiele en compacte kriks voor het veilig heffen en ondersteunen van diverse lasten
- Lage minimumhoogte, direct plaatsbaar onder de last
- Stabiele gelaste constructie voor zware belasting
- Daalsnelheid via aflaatschroef traploos instelbaar
- Voet in hoogte verstelbaar (MH3/ MH8/ MH20)
- Met wielbasis (MH20)

Order nr.	716190003	716190008	716190010	716190020
	€	€	€	€
Orig. nr.	MH3	MH8	MH10	MH20
Capaciteit	T 3	8	10	20
Hoogte minimum	mm 15	20	35	40
Hefhoogte	mm 140	140	160	140
Gewicht	kg 21,50	28,00	25,00	68,00
Prijs	€ 219,00	289,00	239,00	599,00

Heftafels

unicraft



Hydraulische heftafel op wielen. Stevig gelaste constructie. Handig bij montage of nazicht van kleine werkstukken. Hoge stabiliteit door groot eigengewicht. Kwaliteitsvolle hydraulische voetpomp met verchroomde cilinder met PU dichtingen. Secuur leeglooppentiel met constante daalsnelheid. 4 Stevige PU-wielen met rem. Met daal-beveiliging. CE-conform.

Order nr.		758725050 €
Orig. nr.		FHT500
Capaciteit	kg	500
Afmetingen laadvlak	mm	855x550x50
Maximum hoogte	mm	900
Minimum hoogte	mm	340
Gewicht	kg	87,00
Prijs	€	449,00

METALWORKS



Hydraulisch/pneumatische hefbrug met wielklem. Stationair model met capaciteit 700 kg. Voorzien van veiligheid tegen dalen. Uiterust met verbredingsset bestaande uit steunstangen en oprijplaten die zowel tafel als oprijvlak verbreden tot 1218mm. Bij aansluiten van de pneumatische pomp op compressor verhoogt de pompsnelheid. CE-conform.

Order nr.		758725060 €
Orig. nr.		TPSL700
Capaciteit	kg	700
Afmetingen laadvlak	mm	1995x1218
Maximum hoogte	mm	825
Minimum hoogte	mm	185
Afmetingen oprijplaat	mm	550x1218
Afmetingen pomp	mm	600x240x380
Gewicht	kg	174,00
Afmetingen (l x b x h)	mm	206 x 87 x 21
Prijs	€	959,00

unicraft



NEW

Ultracompacte hydraulische motorhefbrug.

- Voor het reinigen, nazien en herstellen van moto's of andere tweewielers
- Oppompen met voethendel
- Compact en tegelijk stabiel met een capaciteit tot 680kg
- Snel opklapbaar, dus ideaal voor kleine werkplaatsen,
- Met 4 meegeleverde spanbanden voor het veilig vastzetten van de voertuigen
- Met 4 wielen, waarvan 2 draaibaar en met rem

Order nr.		716201500 €
Orig. nr.		MH680
Capaciteit	kg	680
Maximum hoogte	mm	410
Minimum hoogte	mm	140
Gewicht	kg	37,00
Afmetingen (l x b x h)	mm	864 x 396 x 315
Prijs	€	177,00

Handstapelaars

unicraft



Manuele stapelaar met capaciteit 1 ton, en maximale werkhogte van 1600mm. Geschikt voor het laden en lossen van vrachtwagens, in magazijnen, etc. Stevig en stabiel gelast stalen frame. door de compacte bouwwijze past deze stapelaar ook in deuropeningen en krappe ruimtes. Nylon loopwielen garanderen een rustige loop op vlakke ondergronden. Veiligheidshandvat met 3 posities.

Order nr.		716151016 €
Orig. nr.		GHHW1000
Capaciteit	T	1
Maximum hoogte	mm	1600
Diameter zwenkwielen	mm	147x40
Diameter topwielen	mm	83x60
Vorken	mm	61x170x1150
Minimum hoogte vorken	mm	90
Chassishoogte	mm	2080
Stuurhoek	°	210
Hefnelheid	mm/s	25
Gewicht	kg	230,00
Afmetingen (l x b x h)	mm	1705 x 755 x 2080
Prijs	€	875,00

HOE KIEST MEN EEN OPRIJPLAAT?

Capaciteit = Gewicht voertuig (in stilstand) x veiligheids capaciteit (15-30%)

vb. 1700 kg = 1300kg x 1,3

Tips:

- Starten/stoppen zorgt voor extra gewicht, hou dus rekening met een veiligheidsmarge(15-30%).
- Grotere overcapaciteit = langere levensduur van de plaat.

- Hou rekening met de opgegeven wielbasis en -breedte van het voertuig.

- Plooibare oprijplaten beschikken over beperkte capaciteit.

- De laadcapaciteit van de plaat mag nooit overschreden worden.

Lengte = Hoogteverschil / helling% x 100

vb. 3m = 0,9m / 30 x 100

Tip:

- Voor uw veiligheid: hellings% mag nooit 30% (= 16,5°) overschrijden

Keuze van de kop (types VAM)

De oprijplaten kunnen optioneel voorzien worden van andere koppen dan de standaardkop.



standaardkop



kop met haak



kop met buis



kop met onderhaak

Keuze van het oppervlak (types VAM)

De oprijplaten kunnen optioneel voorzien worden van rubberstrips (sommige modellen).

Dit is vereist voor voertuigen met stalen rupsen of op rollen. Voorzie 15% extra veiligheids capaciteit.

Oprijplaten

METALWORKS



Loopvlak in polyethyleen, versterkt met stalen kruisen onderaan. Perfect voor op werven of openbare werken. Licht en supersterk tegelijk.

Order nr.	758136858 €	
Orig. nr.	RR1400	
Capaciteit	kg	1000
Lengte	mm	1400
Breedte	mm	800
Gewicht	kg	22,00
Prijs	€	299,00

METALWORKS



NEW

Heavy duty ramp. Gemaakt uit rubber. Geschikt voor zware lasten. Fixatie mogelijk, maar door eigengewicht heel stabiel zonder. Eenvoudig te verplaatsen.

Order nr.	745800727 €	
Orig. nr.	RA10	
Gewicht	kg	70,00
Prijs	€	358,00

METALWORKS

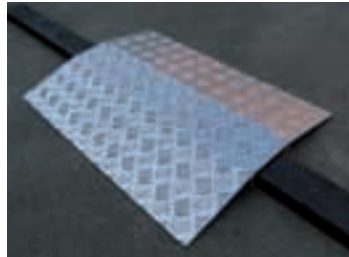

NEW

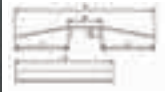

Toegangsbrug.

Order nr.	754752990 €	
Orig. nr.	VAMBAP1	
Capaciteit	kg	450
A	mm	490
B	mm	700
C	mm	40
D	mm	120
E	mm	185
Gewicht	kg	4,00
Afmetingen (l x b x h)	mm	700 x 490 x 40
Prijs	€	234,00

METALWORKS

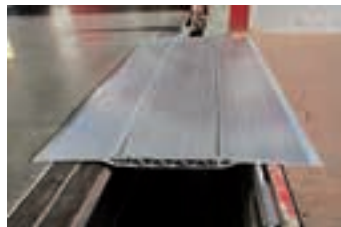

NEW

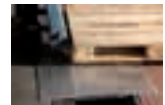

Mobiele laadbrug.

Order nr.	754752991 €	754752992 €
Orig. nr.	MS030/625/2TL	MS030/752/2TL
Capaciteit	kg	3420
Lengte	mm	627
Gewicht	kg	37,40
Afmetingen (l x b x h)	mm	2200 x 637 x 30
Prijs	€	975,00
Order nr.	754752993 €	754752994 €
Orig. nr.	MS030/877/2TL	MS030/1002/2TL
Capaciteit	kg	2510
Lengte	mm	877
Gewicht	kg	48,40
Afmetingen (l x b x h)	mm	2200 x 877 x 45
Prijs	€	1.089,00

METALWORKS



Set van 2 aluminium oprijplaten. Anti-slip oprijplaat met dwarsbuis-structuur. Prima geschikt voor voertuigen met grote banden zoals quads, grasmaaiers enz. Breeksterkte = capaciteit x 1,5. Capaciteit 2x330kg. Superlicht en sterk. Opplooibaar in het midden. Met anti-terugslagbeugel. Gewicht afgebeeld per paar.

Order nr.	754752500 €	
Orig. nr.	VAP2250	
Capaciteit	kg	330
Lengte	mm	2250
Breedte	mm	282
Gewicht	kg	4,50
Prijs	€	174,00

METALWORKS



Aluminium oprijplaat. Scharnierend voor gemakkelijk opbrengen en transporteren. Vlak oppervlak met anti-slip profiel. Geschikt voor lichte objecten tot 200kg. Afgeschuinde kop om gemakkelijk op te rijden. Breeksterkte = capaciteit x 1,5. Laag eigengewicht. Geleverd met veiligheidspal tegen het wegslijpen.

Order nr.	754751810 €	
Orig. nr.	VAP1810	
Capaciteit	kg	200
Lengte	mm	2000
Breedte zijprofiel	mm	294
Interne breedte	mm	250
Gewicht	kg	8,00
Prijs	€	119,00

METALWORKS



Aluminium oprijplaat. Scharnierend voor gemakkelijk opbrengen en transporteren. Vlak oppervlak met anti-slip profiel. Brede uitvoering voor het gemakkelijk laden van voertuigen met 1 oprijplaat. Breeksterkte = capaciteit x 1,5. Capaciteit 400kg. Laag eigengewicht. Geleverd met veiligheidspal tegen het wegslijpen. Met draagbeugels (VAP1910).

Order nr.	754751910 €	754752000 €	754752010 €
Orig. nr.	VAP1910	VAP2000	VAP2010
Capaciteit	kg	400	400
Lengte	mm	2000	2000
Breedte zijprofiel	mm	651	1051
Interne breedte	mm	600	1000
Gewicht	kg	21,00	32,00
Prijs	€	345,00	515,00

METALWORKS

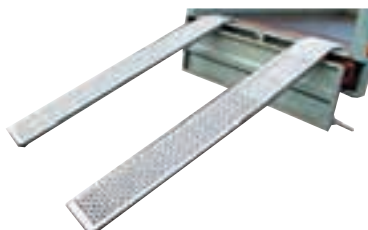

Set vaste oprijplaten met capaciteit 750kg. Met 2,5 of 3 meter zijn deze heel geschikt om grotere hoogtes te overbruggen. Met antislip alu oppervlak. Geleverd per paar. CE-conform en met handleiding. Gewicht afgebeeld per paar.

Order nr.	754752019 €	754752020 €
Orig. nr.	VAM2500-260	VAM3000-260
Lengte	mm	2500
Breedte	mm	260
Capaciteit met wielbasis 0-499mm	kg	650
Capaciteit met wielbasis 500-750mm	kg	750
Capaciteit met wielbasis 751-1200mm	kg	800
Capaciteit met wielbasis engt;1200mm	kg	1000
Gewicht	kg	21,00
Prijs	€	479,00

METALWORKS



Veiligheidsbeugel voor VAM2500 en VAM3000. Dikte 4mm. Deze beugel laat toe om de oprijplaten aan het voertuig vast te maken.

Order nr.	754752013 €	
Orig. nr.	VAM-SRF	
Gewicht	kg	21,00
Prijs	€	20,60

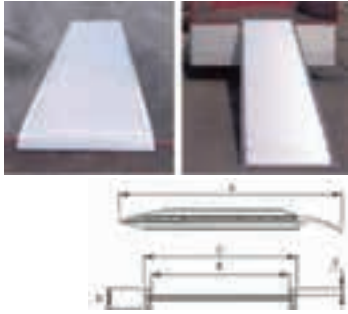

Aluminium oprijplaat in brede uitvoering (1 stuk). Geleverd met standaardkop en veiligheid tegen het wegslaan tijdens het gebruik. Verschillende koppen en veiligheidsopties zijn leverbaar (zie optietabel). Afwijkende afmetingen zijn op bestelling leverbaar

Order nr.	Orig. nr.	Laadcapaciteit	Lengte A	Interne breedte (B)	Externe breedte (C)	Hoogte profiel (D)	Hoogte rand (E)	Gewicht	Prijs
		kg	mm	mm	mm	mm	mm	kg	€
754752956	VAMPC18007501000	1000	1800	690	750	70	23	23,00	645,00
754752957	VAMPC20007501000	1000	2000	690	750	70	23	25,00	670,00
754752958	VAMPC24007501000	1000	2400	690	750	80	23	30,00	710,00
754752959	VAMPC26007501000	1000	2600	690	750	80	23	32,00	790,00
754752960	VAMPC30007501000	1000	3000	690	750	100	23	37,00	840,00
754752961	VAMPC36007501000	1000	3600	690	750	115	36	44,00	970,00
754752962	VAMPC180010001000	1000	1800	940	1000	70	23	34,00	750,00
754752963	VAMPC200010001000	1000	2000	940	1000	70	23	37,00	770,00
754752964	VAMPC240010001000	1000	2400	940	1000	80	23	45,00	800,00
754752965	VAMPC260010001000	1000	2600	940	1000	80	23	48,00	920,00
754752966	VAMPC300010001000	1000	3000	940	1000	100	23	55,00	985,00
754752967	VAMPC360010001000	1000	3600	940	1000	115	36	66,00	1.095,00
754752968	VAMPC400010001000	1000	4000	940	1000	125	36	78,00	1.190,00
754752969	VAMPC440010001000	1000	4400	940	1000	125	36	88,00	1.290,00
754752970	VAMPC500010001000	1000	5000	940	1000	140	32	99,00	1.460,00



Set korte oprijplaten met hoge draagcapaciteit. Flex platen. Uiterst geschikt voor het binnenrijden van containers, of lage drempels. Geleverd per paar. CE conform en met handleiding. Gewicht afgebeeld per paar.

Order nr.	Orig. nr.	Hoogte rand (C)	Profiel hoogte (D)	Capaciteit per paar	Lengte A	Breedte B	Minimum laadhoogte	Gewicht	Prijs
		mm	mm	kg	mm	mm	mm	kg	€
754752021	VAM040B2/05SHF	40	55	1250	500	215	120	6,00	289,00
754752022	VAM040B2/08SHF	40	55	1250	800	215	160	8,00	299,00
754752023	VAM040B3/05SHF	40	55	2000	500	315	120	8,00	299,00
754752024	VAM040B3/08SHF	40	55	2000	800	315	160	12,00	339,00
754752025	VAM080/05SH	80	80	3000	506	300	120	10,00	379,00
754752026	VAM080/08SH	80	80	3000	810	300	160	13,00	419,00
754752027	VAM140/10SH	140	140	7500	1000	500	170	34,00	709,00
754752028	VAM150/12SH	150	150	7500	1256	500	220	41,00	779,00
754752029	VAM150/15SH	150	150	7500	1500	500	270	48,00	849,00
754752030	VAM150/17SH	150	150	7500	1760	500	320	56,00	939,00
754752031	VAM165/20SH	165	165	7500	2000	500	370	69,00	1.009,00

METALWORKS



Set aluminium oprijplaten. Flex platen. Geleverd met standaardkop en aluminium veiligheidshaak tegen het wegslaan tijdens het gebruik. Verschillende koppen en veiligheidsopties zijn leverbaar (zie optietabel). Afwijkende afmetingen zijn op bestelling leverbaar. Gewicht afgebeeld per paar.

Order nr.	Orig. nr.	Lengte	Cap./paar wielbasis 500mm	Cap./paar wielbasis 750mm	Cap./paar wielbasis 1000mm	Externe breedte (A)	Profiel hoogte (B)	Hoogte (C)	Gewicht	Prijs
		mm	kg	kg	kg	mm	mm	mm	kg	€
754752610 E	VAM030B2/15	1500	830	1107	1580	215	30	55	13,00	349,00
754752611 E	VAM030B2/20	2000	553	664	830	215	30	55	16,00	389,00
754752612 E	VAM030B2/25	2500	415	474	553	215	30	55	19,00	409,00
754752613 E	VAM030B2/30	3000	332	369	415	215	30	55	23,00	509,00
754752614 E	VAM030B2/35	3500	277	302	332	215	30	55	26,00	559,00
754752615 E	VAM030B2/40	4000	237	255	277	215	30	55	29,00	589,00
754752616 E	VAM030B2/15/2	1500	1660	2214	2900	415	30	55	24,00	519,00
754752617 E	VAM030B2/20/2	2000	1106	1328	1660	415	30	55	30,00	579,00
754752618 E	VAM030B2/25/2	2500	830	948	1106	415	30	55	37,00	649,00
754752619 E	VAM030B2/30/2	3000	664	738	830	415	30	55	44,00	769,00
754752620 E	VAM030B2/35/2	3500	554	604	664	415	30	55	50,00	799,00
754752621 E	VAM030B2/40/2	4000	474	510	554	415	30	55	57,00	859,00
754752622 E	VAM030B3/15	1500	1178	1570	2355	315	30	55	18,00	399,00
754752623 E	VAM030B3/20	2000	785	942	1178	315	30	55	23,00	439,00
754752624 E	VAM030B3/25	2500	589	673	785	315	30	55	28,00	499,00
754752625 E	VAM030B3/30	3000	471	523	589	315	30	55	33,00	599,00
754752626 E	VAM030B3/35	3500	393	428	471	315	30	55	38,00	659,00
754752627 E	VAM030B3/40	4000	336	362	393	315	30	55	43,00	699,00
754752628 E	VAM030B3/15/2	1500	2356	2900	2900	615	30	55	35,00	619,00
754752629 E	VAM030B3/20/2	2000	1570	1884	2356	615	30	55	45,00	709,00
754752630 E	VAM030B3/25/2	2500	1178	1346	1570	615	30	55	55,00	769,00
754752631 E	VAM030B3/30/2	3000	942	1046	1178	615	30	55	65,00	899,00
754752632 E	VAM030B3/35/2	3500	786	856	942	615	30	55	75,00	999,00
754752633 E	VAM030B3/40/2	4000	672	724	786	615	30	55	85,00	1.079,00



EQUIPMENT

Set aluminium oprijplaten. Flex platen. Model met flexibele eigenschappen zonder opstaande rand. Geleverd met standaardkop en aluminium veiligheidshaak tegen het wegslaan tijdens het gebruik. Verschillende koppen en veiligheidsopties zijn leverbaar (zie optietabel). Afwijkende afmetingen zijn op bestelling leverbaar. Gewicht afgebeeld per paar.

Order nr.	Orig. nr.	Lengte	Cap./paar wielbasis 500mm	Cap./paar wielbasis 750mm	Cap./paar wielbasis 1000mm	Externe breedte (A)	Profiel hoogte (B)	Hoogte (C)	Gewicht	Prijs
		mm	kg	kg	kg	mm	mm	mm	kg	€
754752658 E	VAM040B2/15	1500	1259	1580	1580	215	40	55	14,00	369,00
754752659 E	VAM040B2/20	2000	839	1007	1259	215	40	55	18,00	409,00
754752660 E	VAM040B2/25	2500	630	719	839	215	40	55	22,00	439,00
754752661 E	VAM040B2/30	3000	504	560	630	215	40	55	25,00	539,00
754752662 E	VAM040B2/35	3500	420	458	504	215	40	55	29,00	599,00
754752663 E	VAM040B2/40	4000	360	387	420	215	40	55	33,00	629,00
754752664 E	VAM040B2/15/2	1500	2518	2900	2900	415	40	55	26,00	549,00
754752665 E	VAM040B2/20/2	2000	1678	2014	2518	415	40	55	33,00	609,00
754752666 E	VAM040B2/25/2	2500	1260	1438	1678	415	40	55	41,00	679,00
754752667 E	VAM040B2/30/2	3000	1008	1120	1260	415	40	55	48,00	799,00
754752668 E	VAM040B2/35/2	3500	840	916	1008	415	40	55	56,00	859,00
754752669 E	VAM040B2/40/2	4000	720	774	840	415	40	55	63,00	929,00
754752670 E	VAM040B3/15	1500	2132	2370	2370	315	40	55	21,00	429,00
754752671 E	VAM040B3/20	2000	1421	1705	2132	315	40	55	27,00	479,00
754752672 E	VAM040B3/25	2500	1066	1218	1421	315	40	55	33,00	539,00
754752673 E	VAM040B3/30	3000	853	947	1066	315	40	55	39,00	649,00
754752674 E	VAM040B3/35	3500	711	775	853	315	40	55	45,00	719,00
754752675 E	VAM040B3/40	4000	609	656	711	315	40	55	51,00	779,00
754752676 E	VAM040B3/15/2	1500	2900	2900	2900	615	40	55	40,00	669,00
754752677 E	VAM040B3/20/2	2000	2842	2900	2900	615	40	55	52,00	779,00
754752678 E	VAM040B3/25/2	2500	2132	2436	2842	615	40	55	64,00	829,00
754752679 E	VAM040B3/30/2	3000	1706	1894	2132	615	40	55	76,00	979,00
754752680 E	VAM040B3/35/2	3500	1422	1550	1706	615	40	55	88,00	1.099,00
754752681 E	VAM040B3/40/2	4000	1218	1312	1422	615	40	55	100,00	1.199,00

METALWORKS



PLOOIBAAR

EQUIPMENT

Set aluminium oprijplaten in plooibare versie met scharnieren in het midden. Model met flexibele terugveereigenschappen zonder rand. Geleverd met standaardkop en aluminium veiligheidshaak tegen het wegslaan tijdens het gebruik. Verschillende koppen en veiligheidsopties zijn leverbaar (zie optietabel). Afwijkende afmetingen zijn op bestelling leverbaar. Gewicht afgebeeld per paar.

Order nr.	Orig. nr.	Lengte	Cap./paar wielbasis 500mm	Cap./paar wielbasis 750mm	Cap./paar wielbasis 1000mm	Externe breedte (A)	Profiel hoogte (B)	Hoogte (C)	Gewicht	Prijs	
		mm	kg	kg	kg	mm	mm	mm	kg	€	
754752682	E	VAM040B2/15-P	1500	300	300	300	215	40	55	14,00	579,00
754752683	E	VAM040B2/20-P	2000	300	300	300	215	40	55	18,00	619,00
754752684	E	VAM040B2/25-P	2500	300	300	300	215	40	55	22,00	644,00
754752685	E	VAM040B2/30-P	3000	300	300	300	215	40	55	25,00	754,00
754752686	E	VAM040B2/35-P	3500	300	300	300	215	40	55	29,00	779,00
754752687	E	VAM040B2/40-P	4000	300	300	300	215	40	55	33,00	829,00
754752688	E	VAM040B2/15/2P	1500	300	300	300	415	40	55	26,00	829,00
754752689	E	VAM040B2/20/2P	2000	300	300	300	415	40	55	33,00	879,00
754752690	E	VAM040B2/25/2P	2500	300	300	300	415	40	55	41,00	959,00
754752691	E	VAM040B2/30/2P	3000	300	300	300	415	40	55	48,00	1.069,00
754752692	E	VAM040B2/35/2P	3500	300	300	300	415	40	55	56,00	1.119,00
754752693	E	VAM040B2/40/2P	4000	300	300	300	415	40	55	63,00	1.169,00
754752694	E	VAM040B3/15-P	1500	500	500	500	315	40	55	21,00	634,00
754752695	E	VAM040B3/20-P	2000	500	500	500	315	40	55	27,00	709,00
754752696	E	VAM040B3/25-P	2500	500	500	500	315	40	55	33,00	734,00
754752698	E	VAM040B3/35-P	3500	500	500	500	315	40	55	45,00	839,00
754752697	E	VAM040B3/30-P	3000	500	500	500	315	40	55	39,00	909,00
754752699	E	VAM040B3/40-P	4000	500	500	500	315	40	55	51,00	954,00
754752700	E	VAM040B3/15/2P	1500	500	500	500	615	40	55	40,00	889,00
754752701	E	VAM040B3/20/2P	2000	500	500	500	615	40	55	52,00	984,00
754752702	E	VAM040B3/25/2P	2500	500	500	500	615	40	55	64,00	1.074,00
754752703	E	VAM040B3/30/2P	3000	500	500	500	615	40	55	76,00	1.219,00
754752704	E	VAM040B3/35/2P	3500	500	500	500	615	40	55	88,00	1.329,00
754752705	E	VAM040B3/40/2P	4000	500	500	500	615	40	55	100,00	1.449,00



Set smalle aluminium oprijplaten met veiligheidsrand. Verschillende veiligheidsopties zijn leverbaar (zie optietabel). Afwijkende afmetingen zijn op bestelling leverbaar. Gewicht afgebeeld per paar.

Order nr.	Orig. nr.	Lengte	Cap./paar wielbasis 0mm	Cap./paar wielbasis 500mm	Cap./paar wielbasis 1000mm	Interne breedte (A)	Externe breedte (B)	Hoogte rand (C)	Hoogte (D)	Gewicht	Prijs
		mm	kg	kg	kg	mm	mm	mm	mm	kg	€
754752706	VAM050/10	1000	800	1500	1500	155	246	45	100	9,00	319,00
754752707	VAM050/15	1500	800	1479	1500	155	246	45	100	13,00	359,00
754752708	VAM050/20	2000	739	986	1479	155	246	45	100	17,00	389,00
754752709	VAM050/25	2500	592	739	986	155	246	45	100	20,00	479,00
754752710	VAM050/30	3000	493	592	739	155	246	45	100	24,00	519,00
754752711	VAM050/35	3500	423	493	592	155	246	45	100	28,00	599,00



Set smalle aluminium oprijplaten met veiligheidsrand in plooibare versie met scharnier in het midden. Verschillende veiligheidsopties zijn leverbaar (zie optietabel). Afwijkende afmetingen zijn op bestelling leverbaar. Gewicht afgebeeld per paar.

Order nr.	Orig. nr.	Lengte	Cap./paar wielbasis 0mm	Cap./paar wielbasis 500mm	Cap./paar wielbasis 1000mm	Interne breedte (A)	Externe breedte (B)	Hoogte rand (C)	Hoogte (D)	Gewicht	Prijs
		mm	kg	kg	kg	mm	mm	mm	mm	kg	€
754752712	VAM050/10-P	1000	300	300	300	155	246	45	100	9,00	539,00
754752713	VAM050/15-P	1500	300	300	300	155	246	45	100	13,00	569,00
754752714	VAM050/20-P	2000	300	300	300	155	246	45	100	17,00	599,00
754752715	VAM050/25-P	2500	300	300	300	155	246	45	100	20,00	689,00
754752716	VAM050/30-P	3000	300	300	300	155	246	45	100	24,00	719,00
754752717	VAM050/35-P	3500	300	300	300	155	246	45	100	28,00	779,00

METALWORKS



Set aluminium oprijplaten. Geleverd met standaardkop en aluminium veiligheidshaak tegen het wegslaan tijdens het gebruik. Verschillende koppen en veiligheidsopties zijn leverbaar (zie optietabel). Afwijkende afmetingen zijn op bestelling leverbaar. Gewicht afgebeeld per paar.

Order nr.	Orig. nr.	Lengte	Cap./paar wielbasis 750mm	Cap./paar wielbasis 1000mm	Cap./paar wielbasis 1250mm	Interne breedte (A)	Externe breedte (B)	Hoogte rand (C)	Profiel hoogte (D)	Minimum band- breedte	Gewicht kg	Prijs €
754752718 E	VAM070/15	1500	2457	2457	2457	240	300	23	70	150	19,00	469,00
754752719 E	VAM070/20	2000	1525	1906	2457	240	300	23	70	150	24,00	509,00
754752720 E	VAM070/25	2500	1090	1270	1525	240	300	23	70	150	28,00	609,00
754752721 E	VAM070/30	3000	850	960	1085	240	300	23	70	150	34,00	719,00
754752722 E	VAM070/35	3500	700	765	845	240	300	23	70	150	39,00	774,00
754752723 E	VAM070/40	4000	597	647	706	240	300	23	70	150	43,00	829,00
754752724 E	VAM070/15L	1500	2457	2457	2457	440	500	23	70	300	26,00	584,00
754752725 E	VAM070/20L	2000	1525	1906	2457	440	500	23	70	300	32,00	639,00
754752726 E	VAM070/25L	2500	1090	1270	1525	440	500	23	70	300	38,00	749,00
754752727 E	VAM070/30L	3000	840	960	1085	440	500	23	70	300	46,00	834,00
754752728 E	VAM070/35L	3500	700	765	845	440	500	23	70	300	52,00	899,00
754752729 E	VAM070/40L	4000	597	647	706	440	500	23	70	300	58,00	999,00

METALWORKS



Set aluminium oprijplaten. Geleverd met standaardkop en aluminium veiligheidshaak tegen het wegslaan tijdens het gebruik. Verschillende koppen en veiligheidsopties zijn leverbaar (zie optietabel). Afwijkende afmetingen zijn op bestelling leverbaar. Gewicht afgebeeld per paar.

Order nr.	Orig. nr.	Lengte	Cap./paar wielbasis 1000mm	Cap./paar wielbasis 1250mm	Cap./paar wielbasis 1500mm	Interne breedte (A)	Externe breedte (B)	Hoogte rand (C)	Profiel hoogte (D)	Minimum band- breedte	Gewicht kg	Prijs €
754752730 E	VAM080/20	2000	2457	2457	2457	240	300	23	80	150	26,00	584,00
754752731 E	VAM080/25	2500	1674	2009	2457	240	300	23	80	150	31,00	629,00
754752732 E	VAM080/30	3000	1255	1435	1674	240	300	23	80	150	38,00	759,00
754752733 E	VAM080/35	3500	1004	1116	1255	240	300	23	80	150	43,00	829,00
754752734 E	VAM080/40	4000	837	913	1004	240	300	23	80	150	48,00	860,00
754752735 E	VAM080/45	4500	717	772	837	240	300	23	80	150	55,00	989,00



Set aluminium oprijplaten. Minimale bandbreedte van 200mm, bij de L-types een minimale bandbreedte van 300mm. Geleverd met standaardkop en aluminium veiligheidshaak tegen het wegslaan tijdens het gebruik. Verschillende koppen en veiligheidsopties zijn leverbaar (zie optietabel). Afwijkende afmetingen zijn op bestelling leverbaar. Gewicht afgebeeld per paar.

Order nr.	Orig. nr.	Lengte	Cap./paar wielbasis 1000mm	Cap./paar wielbasis 1250mm	Cap./paar wielbasis 1500mm	Interne breedte (A)	Externe breedte (B)	Hoogte rand (C)	Profiel hoogte (D)	Minimum band- breedte	Gewicht	Prijs
		mm	kg	kg	kg	mm	mm	mm	mm	mm	kg	€
754752736	E VAM100/25	2500	2330	2800	3000	300	360	23	100	200	40,00	714,00
754752737	E VAM100/30	3000	1750	2000	2330	300	360	23	100	200	42,00	719,00
754752740	E VAM100/35	3500	1400	1550	1750	300	360	23	100	200	48,00	879,00
754752741	E VAM100/40	4000	1165	1270	1400	300	360	23	100	200	53,00	969,00
754752742	E VAM100/45	4500	1000	1075	1165	300	360	23	100	200	61,00	1.049,00
754752743	E VAM100/50	5000	875	930	1000	300	360	23	100	200	66,00	1.174,00
754752744	E VAM100/25L	2500	2330	2800	3000	340	400	23	100	300	43,00	749,00
754752745	E VAM100/30L	3000	1750	2000	2330	340	400	23	100	300	52,00	849,00
754752747	E VAM100/35L	3500	1400	1550	1750	340	400	23	100	300	51,00	909,00
754752748	E VAM100/40L	4000	1165	1270	1400	340	400	23	100	300	56,00	994,00
754752749	E VAM100/45L	4500	1000	1075	1165	340	400	23	100	300	64,00	1.049,00
754752750	E VAM100/50L	5000	875	930	1000	340	400	23	100	300	70,00	1.164,00

METAL WORK

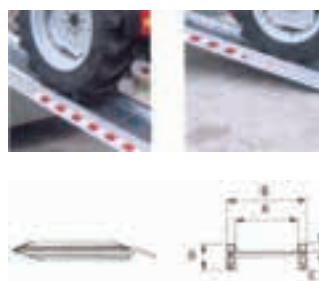

Set aluminium oprijplaten. Geleverd met standaardkop en aluminium veiligheidshaak tegen het wegslaan tijdens het gebruik. Verschillende koppen en veiligheidsopties zijn leverbaar (zie optietabel). Afwijkende afmetingen zijn op bestelling leverbaar. Gewicht afgebeeld per paar.

Order nr.	Orig. nr.	Lengte	Cap./paar wielbasis 1000mm	Cap./paar wielbasis 1250mm	Cap./paar wielbasis 1500mm	Interne breedte (A)	Externe breedte (B)	Hoogte rand (C)	Profiel hoogte (D)	Minimum band- breedte	Gewicht kg	Prijs €
754752751	E VAM115/25	2500	3000	3600	3700	300	360	36	115	200	42,00	739,00
754752752	E VAM115/30	3000	2250	2570	3000	300	360	36	115	200	45,00	799,00
754752754	E VAM115/35	3500	1800	2000	2250	300	360	36	115	200	51,00	799,00
754752756	E VAM115/40	4000	1500	1635	1800	300	360	36	115	200	57,00	999,00
754752757	E VAM115/45	4500	1285	1385	1500	300	360	36	115	200	65,00	1.094,00
754752758	E VAM115/50	5000	1125	1200	1285	300	360	36	115	200	70,00	1.174,00
754752759	E VAM115/25L	2500	3000	3600	4000	340	400	36	115	300	45,00	759,00
754752760	E VAM115/30L	3000	2250	2570	3000	340	400	36	115	300	54,00	859,00
754752762	E VAM115/35L	3500	1800	2000	2250	340	400	36	115	300	62,00	989,00
754752763	E VAM115/40L	4000	1500	1635	1800	340	400	36	115	300	69,00	1.079,00
754752764	E VAM115/45L	4500	1285	1385	1500	340	400	36	115	300	78,00	1.159,00
754752765	E VAM115/50L	5000	1125	1200	1285	340	400	36	115	300	86,00	1.289,00
754752766	E VAM125/25	2500	4500	4500	4500	300	360	36	125	200	47,00	789,00
754752767	E VAM125/30	3000	3435	3925	4500	300	360	36	125	200	58,00	894,00
754752769	E VAM125/35	3500	2750	3050	3435	300	360	36	125	200	66,00	899,00
754752771	E VAM125/40	4000	2290	2500	2750	300	360	36	125	200	73,00	994,00
754752773	E VAM125/45	4500	1965	2115	2290	300	360	36	125	200	84,00	1.199,00
754752774	E VAM125/50	5000	1720	1830	1965	300	360	36	125	200	92,00	1.339,00
754752775	E VAM125/25L	2500	4500	4500	4500	340	400	36	125	300	50,00	769,00
754752776	E VAM125/30L	3000	3435	3925	4500	340	400	36	125	300	61,00	909,00
754752778	E VAM125/35L	3500	2750	3050	3435	340	400	36	125	300	69,00	1.049,00
754752779	E VAM125/40L	4000	2290	2500	2750	340	400	36	125	300	78,00	1.149,00
754752780	E VAM125/45L	4500	1965	2115	2290	340	400	36	125	300	89,00	1.249,00
754752781	E VAM125/50L	5000	1720	1830	1965	340	400	36	125	300	97,00	1.389,00



Set aluminium oprijplaten. Geleverd met standaardkop en stalen veiligheidsbeugel tegen het wegslaan tijdens het gebruik. Verschillende koppen en veiligheidsopties zijn leverbaar (zie optietabel). Afwijkende afmetingen zijn op bestelling leverbaar. Gewicht afgebeeld per paar.

Order nr.	Orig. nr.	Lengte	Cap./paar wielbasis 1000mm	Cap./paar wielbasis 1250mm	Cap./paar wielbasis 1500mm	Interne breedte (A)	Externe breedte (B)	Hoogte rand (C)	Profiel hoogte (D)	Minimum band- breedte	Gewicht	Prijs
		mm	kg	kg	kg	mm	mm	mm	mm	mm	kg	€
754752782 E	VAM140/25	2500	4500	4500	4500	340	400	32	140	300	55,00	889,00
754752783 E	VAM140/30	3000	4155	4500	4500	340	400	32	140	300	67,00	989,00
754752785 E	VAM140/35	3500	3325	3695	4155	340	400	32	140	300	76,00	1.024,00
754752787 E	VAM140/40	4000	2770	3025	3325	340	400	32	140	300	85,00	1.049,00
754752789 E	VAM140/45	4500	2375	2560	2770	340	400	32	140	300	96,00	1.349,00
754752790 E	VAM140/50	5000	2080	2215	2375	340	400	32	140	300	105,00	1.509,00
754752791 E	VAM140/25L	2500	4500	4500	4500	420	480	32	140	300	63,00	1.005,00
754752792 E	VAM140/30L	3000	4155	4500	4500	420	480	32	140	350	77,00	1.079,00
754752794 E	VAM140/35L	3500	3325	3695	4155	420	480	32	140	300	87,00	1.219,00
754752795 E	VAM140/40L	4000	2770	3025	3325	420	480	32	140		98,00	1.340,00
754752796 E	VAM140/45L	4500	2375	2560	2770	420	480	32	140	350	111,00	1.529,00
754752797 E	VAM140/50L	5000	2080	2215	2375	420	480	32	140	350	122,00	1.689,00

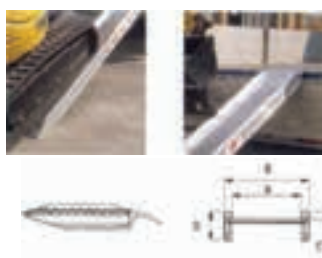

Set aluminium oprijplaten. Geleverd met standaardkop en stalen veiligheidsbeugel tegen het wegslaan tijdens het gebruik. Verschillende koppen en veiligheidsopties zijn leverbaar (zie optietabel). Afwijkende afmetingen zijn op bestelling leverbaar. Gewicht afgebeeld per paar.

Order nr.	Orig. nr.	Lengte	Cap./paar wielbasis 1250mm	Cap./paar wielbasis 1500mm	Cap./paar wielbasis 1750mm	Interne breedte (A)	Externe breedte (B)	Hoogte rand (C)	Profiel hoogte (D)	Minimum band- breedte	Gewicht	Prijs
		mm	kg	kg	kg	mm	mm	mm	mm	mm	kg	€
754752798 E	VAM150/25	2500	6000	6000	6000	340	400	32	150	300	61,00	989,00
754752799 E	VAM150/30	3000	5890	6000	6000	340	400	32	150	300	74,00	1.069,00
754752801 E	VAM150/35	3500	4580	5150	5890	340	400	32	150	300	84,00	1.214,00
754752802 E	VAM150/40	4000	3745	4120	4580	340	400	32	150	300	91,00	1.169,00
754752804 E	VAM150/45	4500	3170	3435	3745	340	400	32	150	300	103,00	1.489,00
754752805 E	VAM150/50	5000	2750	2945	3170	340	400	32	150	300	116,00	1.629,00

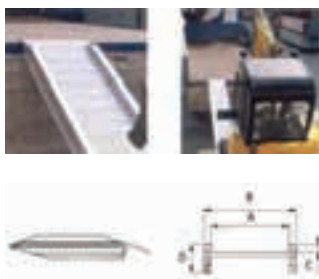

Set aluminium oprijplaten. Geleverd met standaardkop en veiligheidsketting tegen het wegslaan tijdens het gebruik. Verschillende koppen en veiligheidsopties zijn leverbaar (zie optietabel). Afwijkende afmetingen zijn op bestelling leverbaar. Gewicht afgebeeld per paar.

Order nr.	Orig. nr.	Lengte	Cap./paar	Cap./paar	Cap./paar	Interne	Externe	Hoogte	Profiel	Minimum	Gewicht	Prijs
			wielbasis	wielbasis	wielbasis							
		mm	1250mm	1500mm	1750mm	(A)	(B)	(C)	(D)	mm	kg	€
754752806	VAM165/25	2500	6000	6000	6000	420	480	43	165	350	74,00	1.059,00
754752807	VAM165/30	3000	6000	6000	6000	420	480	43	165	350	91,00	1.199,00
754752809	VAM165/35	3500	5620	6000	6000	420	480	43	165	350	103,00	1.359,00
754752810	VAM165/40	4000	4600	5060	5620	420	480	43	165	350	114,00	1.499,00
754752811	VAM165/45	4500	3890	4215	4600	420	480	43	165	350	130,00	1.699,00
754752812	VAM165/50	5000	3375	3615	3890	420	480	43	165	350	142,00	1.849,00
754752813	VAM165/25L	2500	6000	6000	6000	450	510	43	165	400	76,00	1.099,00
754752814	VAM165/30L	3000	6000	6000	6000	450	510	43	165	400	93,00	1.199,00
754752816	VAM165/35L	3500	5620	6000	6000	450	510	43	165	400	105,00	1.419,00
754752817	VAM165/40L	4000	4600	5060	5620	450	510	43	165	400	118,00	1.449,00
754752819	VAM165/45L	4500	3890	4215	4600	450	510	43	165	400	135,00	1.739,00
754752820	VAM165/50L	5000	3375	3615	3890	450	510	43	165	400	147,00	1.899,00

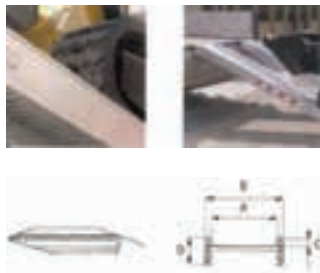

Set aluminium oprijplaten. Geleverd met standaardkop en aluminium veiligheidshaak tegen het wegslaan tijdens het gebruik. Verschillende koppen en veiligheidsopties zijn leverbaar (zie optietabel). Afwijkende afmetingen zijn op bestelling leverbaar. Gewicht afgebeeld per paar.

Order nr.	Orig. nr.	Lengte	Cap./paar	Cap./paar	Cap./paar	Interne	Externe	Hoogte	Profiel	Minimum	Gewicht	Prijs
			wielbasis	wielbasis	wielbasis							
		mm	1500mm	1750mm	2000mm	(A)	(B)	(C)	(D)	mm	kg	€
754752821	VAM170/25	2500	8300	8300	8300	450	530	50	170	400	84,00	1.249,00
754752822	VAM170/30	3000	8300	8300	8300	450	530	50	170	400	103,00	1.399,00
754752823	VAM170/35	3500	7182	8209	8300	450	530	50	170	400	118,00	1.589,00
754752824	VAM170/40	4000	5745	6384	6384	450	530	50	170	400	127,00	1.599,00
754752826	VAM170/45	4500	4788	5254	5745	450	530	50	170	400	144,00	1.799,00
754752828	VAM170/50	5000	4104	4420	4788	450	530	50	170	400	157,00	2.129,00
754752829	VAM170/55	5500	3591	3830	4140	450	530	50	170	400	170,00	2.239,00
754752830	VAM185/25	2500	10000	10000	10000	450	530	57	185	400	100,00	1.369,00
754752831	VAM185/30	3000	10000	10000	10000	450	530	57	185	400	120,00	1.519,00
754752832	VAM185/35	3500	8876	10000	10000	450	530	57	185	400	136,00	1.714,00
754752833	VAM185/40	4000	7100	7889	8876	450	530	57	185	400	148,00	1.869,00
754752834	VAM185/45	4500	5917	6455	7100	450	530	57	185	400	160,00	1.899,00
754752836	VAM185/50	5000	5072	5462	5917	450	530	57	185	400	175,00	2.269,00
754752837	VAM185/55	5500	4438	4733	5072	450	530	57	185	400	190,00	2.380,00



Set aluminium oprijplaten. Geleverd met standaardkop en veiligheidsketting tegen het wegslaan tijdens het gebruik. Verschillende koppen en veiligheidsopties zijn leverbaar (zie optietabel). Afwijkende afmetingen zijn op bestelling leverbaar. Gewicht afgebeeld per paar.

Order nr.	Orig. nr.	Lengte mm	Cap./paar wielbasis	Cap./paar wielbasis	Cap./paar wielbasis	Interne breedte (A) mm	Externe breedte (B) mm	Hoogte rand (C) mm	Profiel hoogte (D) mm	Minimum band- breedte mm	Gewicht kg	Prijs
			1500mm kg	1750mm kg	2000mm kg							€
754752838	ⓔ VAM200/25	2500	12000	12000	12000	500	600	57	200	450	112,00	1.620,00
754752839	ⓔ VAM200/30	3000	12000	12000	12000	500	600	57	200	450	137,00	1.815,00
754752840	ⓔ VAM200/35	3500	10625	12000	12000	500	600	57	200	450	156,00	2.040,00
754752841	ⓔ VAM200/40	4000	8500	9445	10625	500	600	57	200	450	174,00	2.175,00
754752842	ⓔ VAM200/45	4500	7085	7730	8500	500	600	57	200	450	198,00	2.405,00
754752843	ⓔ VAM200/50	5000	6070	6540	7085	500	600	57	200	450	206,00	2.595,00
754752844	ⓔ VAM200/55	5500	5310	5662	6070	500	600	57	200	450	223,00	2.730,00
754752845	ⓔ VAM230/25	2500	12000	12000	12000	500	600	71	230	450	123,00	1.705,00
754752846	ⓔ VAM230/30	3000	12000	12000	12000	500	600	71	230	450	150,00	1.910,00
754752847	ⓔ VAM230/35	3500	120000	120000	120000	500	600	71	230	450	171,00	2.160,00
754752848	ⓔ VAM230/40	4000	120000	120000	120000	500	600	71	230	450	191,00	2.335,00
754752849	ⓔ VAM230/45	4500	10008	10918	12000	500	600	71	230	450	219,00	2.570,00
754752850	ⓔ VAM230/50	5000	8578	9238	10008	500	600	71	230	450	239,00	2.880,00
754752851	ⓔ VAM230/55	5500	7506	8006	8578	500	600	71	230	450	260,00	3.060,00



VAM V1

VAM V2

VAM V3

VAM V4

G

T

A

Accessoires voor oprijplaten.

Order nr.	Orig. nr.	Omschrijving	Voor type	Gewicht kg	Prijs €
754752975	ⓔ VAM V1	Stalen veiligheidsbeugel	VAM140/150	99,00	63,00
754752976	ⓔ VAM V2	Alu veiligheidshaak	VAM030/40/70/80/100/115A/125	99,00	63,00
754752977	ⓔ VAM V3	Veiligheidsketting	VAM	99,00	63,00
754752978	ⓔ VAM V4	Veiligheidspin	VAM	99,00	15,00
754752979	ⓔ VAM K1	Kop met haak 'G'	VAM040/50/70/80/100/115A/125	99,00	187,00
754752980	ⓔ VAM K2	Kop met haak 'G'	VAM120S/140/150/165/170/185/200/230	99,00	-
754752981	ⓔ VAM K3	Kop met buis 'T'	VAM040/50/70/80/100/115A/125	99,00	187,00
754752982	ⓔ VAM K4	Kop met buis 'T'	VAM120S/140/150/165/170/185/200/230	99,00	-
754752983	ⓔ VAM K5	Kop met weerhaak 'A'	VAM040/50/70/80/100/115A/125	99,00	187,00
754752984	ⓔ VAM K6	Kop met weerhaak 'A'	VAM120S/140/150/165/170/185/200/230	99,00	-



Elektrische takels 220V

METALWORKS



Robuuste 220 V takels. Geleverd met afstandsbediening met kabel en haak met veiligheidsclip. Met noodstop op bedieningspaneel. Eindeloopswitch en anti-omkeerswitch. IP54 beschermingsklasse en CE gekeurd. Chassis voorzien voor montage op de takelhouder PP300/1100 of PP600/750. Inschakelduur: 20%: Per 10 minuten kan er 2 minuten gehesen worden.

Order nr.	758611250 €	758612040 €	758613060 €
Orig. nr.	SH125/250	SH200/400	SH300/600-12
Capaciteit	kg 125/250	200/400	300/600
Spanning	V 230	230	230
Type haak	enkel/dubbel	enkel/dubbel	enkel/dubbel
Heffhoogte	m 12/6	12/6	12/6
Heffsnelheid	m/min 8/4	8/4	8/4
Diameter kabel	mm 3	4	5
Vermogen motor	kW 0,5	0,75	1,05
Lengte kabel afstandsbediening	m 1,6	1,6	1,6
Gewicht	kg 12,50	16,50	17,50
Afmetingen (l x b x h)	mm 333 x 132 x 200	381 x 147 x 243	381 x 140 x 235
Prijs	€ 119,00	169,00	239,00

Order nr.	758613070 €	758611012 €
Orig. nr.	SH300/600-18	SH500/1000
Capaciteit	kg 300/600	500/1000
Spanning	V 230	230
Type haak	enkel/dubbel	enkel/dubbel
Heffhoogte	m 18/9	18/9
Heffsnelheid	m/min 8/4	8/4
Diameter kabel	mm 5	6
Vermogen motor	kW 1,05	1,6
Lengte kabel afstandsbediening	m 1,6	1,6
Gewicht	kg 36,00	34,00
Afmetingen (l x b x h)	mm 520 x 440 x 240	540 x 440 x 310
Prijs	€ 289,00	389,00

METALWORKS



Takelhouder voor elektrische takels TPSPE. Geleverd met beugels, montagebouten en -moeren voor montage op ronde buizen diam. 48 mm. Geschikt voor SH125, SH200 en SH300.

Order nr.	758611001 €	758611010 €
Orig. nr.	PP300/1100	PP600/750
Geschikt voor modellen	125/250	200/400, 300/600, 300/600-18
Capaciteit	kg 300	600
Lengte arm	mm 1100	750
Gewicht	kg 30,00	22,00
Prijs	€ 76,90	87,90

Elektrische takels 12V & 24V

Unitcraft



Compacte elektrische takel 12V voor het optakelen van lichte voertuigen, machines, boten, ... tot 900kg. Met afstandsbediening. Met slippkoppeling tegen overbelasting. IP54 spatwater- en stofdicht.

Order nr.	716190900 €	
Orig. nr.	ESW900	
Spanning	V	12
Kabel lengte	m	9
Capaciteit	kg	900
Kabeldikte	mm	5,6
Nominale stroom	A	25
Vermogen	W	300
Treksnelheid	m/min	0,6
Beschermingsklasse	IP	54
Gewicht	kg	13,00
Afmetingen (l x b x h)	mm	570 x 485 x 250
Prijs	€	105,00

HOE KIES JE EEN GESCHIKTE TAKEL?

Het Superwinch-assortiment bevat 4 groepen lieren: De instapmodellen, de all-round lieren, de industriële modellen en de hydraulische lieren. De belangrijkste parameters zijn voltage, snelheid en capaciteit. De grenscapaciteit is de last die de lier kan trekken als de kabel op de eerste laag van de drum ligt. De technische capaciteit geldt voor de 4de laag van de drum, en is dus van toepassing voor het takelen vlakbij de lier.

De last die getrokken dient te worden, kan als volgt berekend worden:

$$\text{FORMULE } (Y \times Z \times 0,017) + (Y \times F)$$

Y = gewicht van het voertuig in kg

Z = aantal graden waaronder de wagen dient getrokken te worden

F = factor van de ondergrond

vb: wagen 2000 kg trekken onder een hoek van 20 graden op een trailer

$$(2000 \times 20 \times 0,017) + (2000 \times 0,05)$$

$$680 \times 100 = 780 \text{ kg (technische capaciteit)}$$

Hiervoor heb je dus minimum een lier nodig die een technische capaciteit heeft van 780 kg.

Type ondergrond	Factor (F)
Hard-metaal-asfalt	0,05
Gras	0,15
Zand (Hard-nat)	0,17
Gravel	0,2
Zand (zacht-nat)	0,2
Zand (zacht-droog/los)	0,25
Modder (ondiep)	0,33
Moeras	0,5
Klei	0,5

OPMERKING: SUPERWINCH TAKELS MOGEN NIET GEBRUIKT WORDEN OM TE HEFFEN - ENKEL OM TE TREKKEN!



LT2000



UT3000

SUPERWINCH

EQUIPMENT

Elektrische lieren 12V. Krachtige en betrouwbare instapmodellen. Compleet geleverd met: rubber afstandsbediening met kabel L.3,5m, kabelgeleider, montageplaat, katrol, manuele koppeling/vrijloop.

Meer info op www.superwinch.com

UT3000: dynamische rem, volmetalen overbrenging.

Order nr.		758201228 ^E	758201230 ^E
Orig. nr.		LT2000	UT300012V
Spanning	V	12	12
Grenscapaciteit	kg	907	1361
Technische capaciteit	kg	630	880
Vermogen motor	kW	0,5	0,9
Overbrenging		153:1	153:1
Kabel diameter	mm	4	4,8
Kabel lengte	m	15,2	12
Diameter drum	mm	31,75	31,80
Lengte drum	mm	73,6	72
Snelheid - benodigde Ampère bij belasting 0 kg	m/min - A	3,0 - 10	2,6 - 5
Snelheid - benodigde Ampère bij belasting 907 kg	m/min - A	2,5 - 100	1,2 - 65
Snelheid - benodigde Ampère bij belasting 1361 kg	m/min - A		0,6 - 110
Gewicht	kg	5,90	8,90
Afmetingen (l x b x h)	mm	317 x 100 x 104	305 x 190 x 178
Prijs	€	266,00	307,00



SUPERWINCH



LP8500



LP10000

Elektrische lieren 12V, betrouwbare en performante modellen. Compleet met : rubber afstandsbediening met kabel L.3,5m, haak, weersbestendige motor, manuele koppeling/vrijloop, kabbeleider (LP10000), circuitbeveiliging, zonder montageplaat.

Meer info op www.superwinch.com

Order nr.		758208500 E	758208600 E
Orig. nr.		LP8500	LP10000
Spanning	V	12	12
Grenscapaciteit	kg	3856	4536
Technische capaciteit	kg	2600	2880
Vermogen motor	kW	3,37	3,8
Overbrenging		235:1	235:1
Kabel diameter	mm	8,3	9,5
Kabel lengte	m	29	26
Diameter drum	mm	63,50	
Lengte drum	mm	224,00	
Snelheid - benodigde Ampère bij belasting 0 kg	m/min - A	5,5 - 84	5,7 - 85
Snelheid - benodigde Ampère bij belasting 1134 kg	m/min - A	3,0 - 156	
Snelheid - benodigde Ampère bij belasting 2041 kg	m/min - A	2,3 - 215	
Snelheid - benodigde Ampère bij belasting 2948 kg	m/min - A	1,8 - 270	
Snelheid - benodigde Ampère bij belasting 3856 kg	m/min - A	1,1 - 320	
Snelheid - benodigde Ampère bij belasting 2721 kg	m/min - A		2,2 - 245
Snelheid - benodigde Ampère bij belasting 4536 kg	m/min - A		1,5 - 350
Gewicht	kg	34,50	40,80
Afmetingen (l x b x h)	mm	533 x 160 x 218	533 x 160 x 218
Prijs	€	819,00	895,00



Elektrische lieren 12 en 24 V. Standaard geleverd met : rubber afstandbediening met kabel van 9m. Automatische mechanische rem. Power in/uit. Manuele koppeling/vrijloop. Continue smering van de aandrijving. Kabel met aansluiting op de takel. Circuitbeveiliging. Kabelgeleiding. De takels kunnen zonder plaat direct gemonteerd worden. Draadloze afst. bediening optioneel.

Meer info op www.superwinch.com

Order nr.		758204302 E	758204303 E	758204402 E	758204403 E	758204502 E	758204503 E
Orig. nr.		S300012V	S300024V	S400012V	S400024V	S500012V	S500024V
Spanning	V	12	24	12	24	12	24
Grenscapaciteit	kg	1360	1360	1820	1820	2270	2270
Technische capaciteit	kg	950	950	1235	1235	1475	1475
Vermogen motor	kW	1	1	1,3	1,3	1,6	1,6
Overbrenging		153:1	153:1	153:1	153:1	153:1	153:1
Kabel diameter	mm	4,8	4,8	5,5	5,5	6,4	6,4
Kabel lengte	m	18,2	18,2	18,2	18,2	15,2	15,2
Diameter drum	mm	41	41	41	41	41	41
Lengte drum	mm	76	76	76	76	76	76
Snelheid - benodigde Ampère bij belasting 0 kg	m/min - A	8,4 - 15		9,7 - 30		9,4 - 36	
Snelheid - benodigde Ampère bij belasting 1134 kg	m/min - A	2,3 - 155		3,2 - 180			
Snelheid - benodigde Ampère bij belasting 907 kg	m/min - A	2,7 - 117		3,8 - 155		3,4 - 135	
Snelheid - benodigde Ampère bij belasting 1361 kg	m/min - A	1,4 - 220		2,7 - 215		2,2 - 200	
Snelheid - benodigde Ampère bij belasting 454 kg	m/min - A	3,8 - 70		4,8 - 90		4,6 - 80	
Snelheid - benodigde Ampère bij belasting 1589 kg	m/min - A			1,9 - 250			
Snelheid - benodigde Ampère bij belasting 1814 kg	m/min - A			1,4 - 311		1,3 - 265	
Snelheid - benodigde Ampère bij belasting 2268 kg	m/min - A					1,4 - 350	
Gewicht	kg	17,30	17,30	18,20	18,20	19,10	19,10
Afmetingen (l x b x h)	mm	384 x 220 x 152	384 x 220 x 152	384 x 220 x 152	384 x 220 x 152	384 x 220 x 152	384 x 220 x 152
Prijs	€	759,00	759,00	775,00	849,00	819,00	899,00



SUPERWINCH



Elektrische lieren 12 en 24 V. Professionele, betrouwbare en snelle takels voor montage op vrachtwagens, aanhangwagens, terreinwagens, ... Gebouwd voor gebruik in zware omstandigheden. Automatische mechanische rem. Manuele vrijloop. 2-traps overbrenging. Circuitbeveiliging met speciaal ontwikkelde, waterdichte solenoïde. Standaard geleverd met kabel, zware haak, 4-weg kabelgeleiding en afstandbediening 4,5m. Op aanvraag leverbaar in uitvoering met synthetisch touw. Draadloze afst. bediening optioneel.

Meer info op www.superwinch.com

Order nr.		758307956 €	758307959 €	758307970 €	758307973 €	758307989 €	758307992 €
Orig. nr.		TALON 95I-12V	TALON 95I-24V	TALON 125I-12V	TALON 125I-24V	TALON 180-12V	TALON 180-24V
Spanning	V	12	24	12	24	12	24
Grenscapaciteit	kg	4309	4309	5670	5670	8165	8165
Vermogen motor	kW	3,8	3,8	4,48	4,48	4,48	4,48
Overbrenging		148:1	148:1	148:1	148:1	346:1	346:1
Kabel diameter	mm	9,5	9,5	9,5	9,5	13	13
Kabel lengte	m	26	26	26	26	27	27
Snelheid - Benodigde Ampère onbelast	m/min - A	18,9 - 75	18,9 - 75	18,89 - 75	18,89 - 75	7,62 - 75	7,62 - 75
Snelheid - Benodigde Ampère bij grenscapaciteit	m/min - A	1,5 - 430	1,5 - 430	3,25 - 530	3,25 - 530	0,76 - 415	0,76 - 415
Gewicht	kg	42,00	42,00	43,00	43,00	78,00	78,00
Afmetingen (l x b x h)	mm	615.2 x 157.5 x 270.75	615.2 x 157.5 x 270.75	624.2 x 157.5 x 270.76	624.2 x 157.5 x 270.76	689.5 x 215 x 294.21	689.5 x 215.5 x 294.21
Prijs	€	1.079,00	1.079,00	1.209,00	1.209,00	1.779,00	1.780,00

SUPERWINCH



Synthetische touwen vervaardigd uit Dyneema (R) kwaliteitsvezels, bestand tegen de meeste chemicaliën zoals motoroliën en zout. Ze bieden ook hoge weerstand tegen UV-straling en water. In tegenstelling tot klassieke staaldraad, verdragen ze hoge piekladingen, tot tegen de breeksterkte. Veilig in gebruik want lage uitrekking, en weinig terugslag zelfs bij heel zware belasting. Extreem sterk, en slechts 1/10 van het gewicht van een even dikke staaldraad.

Order nr.	758209670	758209671
Orig. nr.	771130	771030
Voor type	EP12.5	EP6/9
Lengte	m 30	30
Dikte	mm 11	10
Gewicht	kg 2,00	3,00
Prijs	€ 509,00	459,00

Order nr.	758307981	758308000
Orig. nr.	90-24506	90-24564
Voor type	TALON 9.5 en 12.5	TALON 14 en 18
Lengte	m 24	27
Dikte	mm 9,5	13
Gewicht	kg 1,00	1,00
Prijs	€ 625,00	1.029,00

SUPERWINCH



758205011 758205012 758304811

Afstandsbediening met kabel voor Superwinch takels.

Order nr.	758205011	758205012	758304811
Orig. nr.	2270	2271	87-12869
Voor type	GP1800 - GP2300 GP3000 - S3000 - S4000 - S5000 - EP6 - EP16 - EP9 - EP19 - EP12.5 - EP16.5	GP1800 - GP2300 - GP3000 - S3000 - S4000 - S5000 - EP6 - EP16 - EP9 EP19 - EP12.5 - EP16.5	IT2000
Lengte	m 4,5	9	2
Type afstandsbediening	kabel	kabel	kabel
Gewicht	kg 1,00	1,00	1,00
Prijs	€ 99,90	118,00	79,00

Order nr.	758201666	758308047
Orig. nr.	90-12864	90-32471
Voor type	UT3000-LP8500-IT10000	TALON
Lengte	m 3,5	4
Type afstandsbediening	kabel	kabel
Gewicht	kg 1,00	1,00
Prijs	€ 43,50	57,50

SUPERWINCH



Montageplaat om een Superwinch takel op een vloer of bodem vast te maken.

Order nr.	Orig. nr.	Voor type	Gewicht kg	Prijs €
758208501	258007	LP8500/10000	5,00	174,00
758303223	258001	EP6-EP9-Tal. 9.5-Tal. 12.5	1,00	204,00
758302314	258006	EP12,5 - EP16,5	1,00	159,00
758302315	216001	EP14 - EP18	1,00	174,00

SUPERWINCH



Haken - katrollen voor lieren.

Order nr.	758305617
Orig. nr.	SUP7750
Voor type	EP9,TALON, LP8500, LP10000
Gewicht	kg 1,00
Prijs	€ 119,00

SUPERWINCH



Draadloze Afstandsbediening voor Superwinch takels.

Order nr.	758301508	758301512	758301513
Orig. nr.	06715	6717	6719
Voor type	TALON	S3000-S4000-S5000	TERRA SERIES
Type afstandsbediening	draadloos	draadloos	draadloos
Gewicht	kg 1,00	1,00	1,00
Prijs	€ 319,00	319,00	319,00

Mechanische takels

METALWORKS



Manuele lier met 7,6m staalkabel, haak en veiligheidslip. CE-conform.

Order nr.	758580250	
Orig. nr.	HNHW250	
Lengte kabel	m	7,6
Diameter kabel	mm	4
Capaciteit	kg	1100
Gewicht	kg	5,25
Prijs	€	44,50

METALWORKS

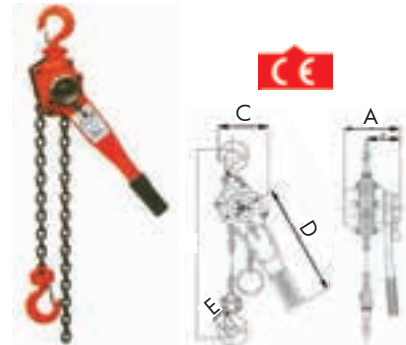

Rateltakel. Deze handtakel is een prima handtakel voor gebruik onder middelzware tot zware omstandigheden. Prima prijs-kwaliteitsverhouding. Kenmerken: Met lastdrukrem die de last op elke positie vasthoudt. Boven- en onderhaak voorzien van veiligheidslip. Verzinkte kettingen.

Order nr.	758580750	758581500	758583000	
Orig. nr.	HNCRT075	HNCRT150	HNCRT300	
Capaciteit	T	0,75	1,5	3
Lengte ketting	m	1,5	1,5	1,5
Testcapaciteit	T	1.13	2,25	4,5
H minimum	mm	325	380	480
Nodige kracht voor maximum lift	N	140	220	320
Schakel kettingen	dia. mm	6	8	10
A	mm	148	172	200
B	mm	90	98	115
C	mm	136	160	180
D	mm	35	47	54
E	mm	29	38	44
L hendel	mm	280	410	410
Gewicht	kg	7,00	11,00	21,00
Prijs	€	105,00	139,00	204,00

METALWORKS



Prima handtakel voor gebruik onder middelzware tot zware omstandigheden. Prima prijs-kwaliteitsverhouding. Kenmerken: Met lastdrukrem die de last op elke positie vasthoudt. Boven- en onderhaak voorzien van veiligheidslip. Verzinkte kettingen.

Order nr.	758580525	758581025	758581060	
Orig. nr.	HNSJ0525	HNSJ1025	HNSJ1060	
Capaciteit	T	0,5	1	1
Lengte ketting	m	2,5	2,5	6
Testcapaciteit	T	0,75	1,5	1,5
H minimum	mm	271	400	400
Nodige kracht voor maximum lift	N	221	304	304
Aantal kettingen		1	1	1
Schakel kettingen	dia. mm	6	6	6
A	mm	138	164	164
B	mm	114	124	124
C	mm	21,5	27	27
D	mm	145	182	182
Lengte aandrijfketting	m	5	5	12
Gewicht	kg	9,00	11,00	16,95
Prijs	€	62,90	82,90	102,00

Order nr.	758581525	758582025	758582060	
Orig. nr.	HNSJ1525	HNSJ2025	HNSJ2060	
Capaciteit	T	1,5	2	2
Lengte ketting	m	2,5	2,5	6
Testcapaciteit	T	2,25	3	3
H minimum	mm	453	420	420
Nodige kracht voor maximum lift	N	343	314	314
Aantal kettingen		1	2	2
Schakel kettingen	dia. mm	8	6	8
A	mm	198	164	164
B	mm	142	124	124
C	mm	30	30	30
D	mm	219	182	182
Lengte aandrijfketting	m	5	5	12
Gewicht	kg	17,00	15,00	23,75
Prijs	€	106,00	109,00	167,00

Order nr.	758583030	758585030	
Orig. nr.	HNSJ3030	HNSJ5030	
Capaciteit	T	3	5
Lengte ketting	m	3	3
Testcapaciteit	T	4,5	6,25
H minimum	mm	620	704
Nodige kracht voor maximum lift	N	343	382
Aantal kettingen		2	2
Schakel kettingen	dia. mm	8	10
A	mm	198	228
B	mm	142	167
C	mm	37	46
D	mm	219	252
Lengte aandrijfketting	m	6	6
Gewicht	kg	24,00	39,00
Prijs	€	139,00	223,00



Unicraft



Domme kracht. Stabiele stalen krik, gebouwd volgens DIN7355. Gemakkelijk hijsen met weinig inspanning. Beveiligde zwen gel is opklapbaar. Met eindeloopbeveiliging.

Order nr.	716170103 E	716170105 E	716170110 E
Orig. nr.	SW3	SW5	SW10
Capaciteit	T 3	5	10
A	mm 83	108	124
B	mm 130	140	140
C	mm 735-1090	730-1076	800-1190
D	mm 70-425	80-425	100-490
Hoogte	mm 735	730	800
Hefhoogte	mm 235	217	187
E	mm 60	71	86
F	mm 45	68	76
G	mm 138	170	170
H	mm 249	275	300
K	mm 170	190	252
R	mm 140	155	185
S	mm 235	217	187
T	mm 128	128	250
Gewicht	kg 21,00	30,00	48,00
Prijs	€ 169,00	211,00	327,00

METALWORKS



HNP20

Kabeltakel 2 of 4 ton met staakabel en bevestigingshaak op beide uiteinden. Werkt onder alle hoeken, verticaal en horizontaal. Ideaal werktuig voor boten, auto's, buitenwerk enz. Geperste stalen constructie met dubbele pinveiligheid. Dubbel wiel en dubbele klauw. Hefratio: 15:1.

Order nr.	758580020 E	758580040 E
Orig. nr.	HNP20	HNP40
Capaciteit	T 2	4
Lengte kabel	m 3	3
Diameter kabel	mm 4,8	5
Gewicht	kg 3,00	5,00
Prijs	€ 21,50	33,90

METALWORKS



Staaldraadtakel met doorgaande kabel. Werkt onder alle hoeken, verticaal en horizontaal, en kan zowel voor hijsen als trekken worden gebruikt. Bvb lasten vereffen, tenten beveiligen, hijsen van kisten, bosbouw, kabels trekken, ... Zeer eenvoudig en robuust systeem. Inclusief 20m staaldraadkabel met haak en veiligheidsklep en hendel. Voorzien van een veiligheidspin tegen overbelasting.

Order nr.	758580140 E	758580160 E	758583200 E
Orig. nr.	KT800	KT1600	KT3200
Hijsvermogen	kg 800	1600	3200
Trekvermogen	kg 1200	2400	4000
Diameter staaldraad x lengte	mm 8.3 x 20m	11 x 20m	16 x 20m
Gewicht	kg 14,50	26,00	14,00
Afmetingen (l x b x h)	mm 426 x 238 x 64	545 x 284 x 97	660 x 325 x 116
Prijs	€ 114,00	215,00	329,00

METALWORKS



Wisselstukken en accessoires voor KT-staaldraadtakels.

Order nr.	Orig. nr.	Omschrijving	Voor type	Gewicht	Prijs
				kg	€
758580161 E	KT1600VP	Breekpen	KT1600	0,20	6,10
758580167 E	KT800VP	Breekpen	KT800	0,20	6,10
758580162 E	KT1600K20	Vervangkabel KT1600 - L20m		4,00	69,00
758580164 E	KT3200VP	Breekpen	KT3200	0,20	6,10
758580168 E	KT800K20	Vervangkabel 20m	KT800	4,00	59,00
758580165 E	KT3200K20	Vervangkabel 20m	KT3200	4,00	68,00
758580169 E	KT800H	Reservehendel	KT800	1,00	17,50
758580163 E	KT1600H	Reservehendel	KT1600	1,00	17,50
758580166 E	KT3200H	Reservehendel	KT3200	1,00	17,50

Permanente hefmagneten

Unicraft



Hefmagneet voor bevestiging aan takels, katrollen, rolbruggen... bijvoorbeeld voor montage van steeldeck dakplaten, vervangen van matrijzen of klauwplaten, montage op de werf, ... Mechanisch instelbaar voor eenvoudig aankoppelen van werkstukken aan takels of hefbruggen. CE-conform.

Order nr.	Orig. nr.	Capaciteit	Gewicht	Afmetingen (l x b x h)	Prijs
		T	kg	mm	€
716170001 E	PLM100	0,1	17,50	265 x 115 x 220	149,00
716170003 E	PLM300	0,3	17,50	265 x 115 x 220	287,00
716170006 E	PLM600	0,6	17,50	265 x 115 x 220	655,00
716170010 E	PLM1000	1,0	37,50	325 x 145 x 250	2.335,00

Rails & sjobanden voor rails

METALWORKS



Bevestigingsrail BARAIL in staal met rechte openingen voor sjobanden PBLSJ of PBLSZ en ronde voor stootbaar BAST24.

Order nr.	751981001	751987013
Orig. nr.	BARAIL1M	BARAIL3MPR
Lengte	mm 1000	3000
Prijs	€ 22,50	43,50

METALWORKS



Bevestigingsrail in aluminium. Geschikt voor opbouw montage.

Te gebruiken in combinatie met volgende items :

- musketons BAM400
- sjoband 2,5m BAS025A of sjoband 5m BAS050A
- stootbaar BAST20

Order nr.	751987025
Orig. nr.	BARA25A
Lengte	mm 3000
Diameter aansluiting	mm 20
Prijs	€ 54,00

METALWORKS



Bevestigingsrail in aluminium. Geschikt voor verzonken montage.

Te gebruiken in combinatie met volgende items : - musketons BAM400 - sjoband 2,5m BAS025A of sjoband 5m BAS050A - stootbaar BAST20

2540mm/vanaf 31/01/'14: 3000mm.

Order nr.	751987026
Orig. nr.	BARA25B
Lengte	mm 3000
Diameter aansluiting	mm 20
Prijs	€ 53,90

METALWORKS



Set van 2 korte rails type B van 120mm en 2 musketons. Klaar voor gebruik. Geleverd met bevestigingsaccessoires.

Order nr.	751987010
Orig. nr.	BAMS22
Lengte	mm 2 x 120
Capaciteit	kg 450
Prijs	€ 22,50

METALWORKS



Set van 4 musketons voor rails BARA25A en BARA25B. Cap. 1500kg.

Te gebruiken in combinatie met volgende items :

- ALU rail BARA25A of ALU rail BARA25B
- sjoband 2,5m BAS025A of sjoband 5m BAS050A

Order nr.	751987028
Orig. nr.	BAM400
Capaciteit	kg 1500
Prijs	€ 9,30

METALWORKS



Set van 4 musketons voor rails BARAIL3MPR en passend voor sjobanden PBLSJ. Cap. 1850kg.

Order nr.	751987032
Orig. nr.	BAM600
Capaciteit	kg 1850
Prijs	€ 16,50

METALWORKS



Complete set van aluminiumrail met 4 verplaatsbare musketons en sjoband 2,5m.

Bij de rails heeft u keuze uit een model voor opbouw (type A) of inbouw (type B).

Order nr.	751987029 €	751987030 €
Orig. nr.	BAM25AS	BAM25BS
Omschrijving	set rail BARA25A + 4 musketons en sjoband BAS025A	set rail BARA25B + 4 musketons en sjoband BAS025A
Lengte rail mm	3000	2540
Prijs €	61,00	60,90

METALWORKS



Sjorband PBLSJ met ratel passend op de bevestigingsrail type BARAIL. Set bestaande uit ratel met band en eindfitting. Leverbaar per 1 of 5 stuks.

Order nr.	Orig. nr.	Lengte m	Breedte mm	Capaciteit LC bij recht gebruik daN	Capaciteit LC bij omsnoering daN	VE	Prijs/VE €
751985181 €	PBLSJ20	2	55	500	1000	1	15,50
751985191 €	PBLSJ30	3	55	500	1000	1	16,90
751985200 €	PBLSJ40	4	55	500	1000	1	16,90
751985201 €	PBLSJ50	5	55	500	1000	1	16,50
751985182 €	PBLS20S	2	55	500	1000	5	60,90
751985192 €	PBLS30S	3	55	500	1000	5	71,50
751985202 €	PBLS40S	4	55	500	1000	5	71,50
751985204 €	PBLS50S	5	55	500	1000	5	77,50

METALWORKS



Sjorband PBLSZ met buckle-sluiting passend op de bevestigingsrail type BARAIL.

Order nr.	757570020 €	757570050 €
Orig. nr.	PBLSZ20	PBLSZ50
Lengte m	2	5
Capaciteit klemgesp kg	1500	1500
Capaciteit band kg	1400	1400
Prijs €	29,50	31,90

VC



Stalen ronde stootbalk. Met geveerd vergrendelingsstelsel. Eenvoudig en vlug te ontgrendelen. Hiermee kan u materiaal vastmaken of blokkeren. Wordt enkel staand gebruikt. Gewicht: 7,5 kg. In combinatie met rail BARAIL te gebruiken.

Order nr.	940001239 €
Orig. nr.	BAST24
Lengte mm	2263-2006
Diameter mm	58
Diameter aansluiting mm	ø 24
Prijs €	47,50

METALWORKS



Ronde stootbaar geschikt voor rails van type BARA25A en BARA25B. Dit stevige stalen steunpunt is ideaal om machines, goederen, etc. veilig vast te sjoeren in vrachtwagens of bestelwagens. Vastklemming gebeurt met een veer. Zowel horizontaal als verticaal bruikbaar.

Order nr.	751987023 €
Orig. nr.	BAST20
Lengte mm	2006-2362
Diameter mm	38
Diameter aansluiting mm	20
Prijs €	43,50



Sjorbanden

METALWORKS



Sjorband met ratel en 2 S-haken.

Order nr.	757571212 €	
Orig. nr.	BAS12A	
Lengte	m	5
Breedte	mm	25
Prijs	€	10,00

METALWORKS



Sjorband met ratel en 2 J-haken. Vrachtgordel 35 mm - 1 kort stuk lengte 0,3 m met ratelspanner en stalen J-haak. Sjorband lengte 6 m. Gekeurd.

Order nr.	757571150 €	
Orig. nr.	BAS115B	
Lengte	m	6,0 + 0,3
Breedte	mm	35
Capaciteit LC bij recht gebruik	daN	1250
Capaciteit LC bij gebruik in omsnoering	daN	2500
Capaciteit STF	daN	150
Prijs	€	7,50

METALWORKS



Vrachtgordel 50 mm - 1 kort stuk lengte 0,5 m met ratelspanner met lange en brede greep en stalen J-haak. Sjorband lengte 9 m. Gekeurd.

Order nr.	757575151 €	
Orig. nr.	BAPCL51S	
Lengte	m	9,0 + 0,5
Breedte	mm	50
Capaciteit LC bij recht gebruik	daN	2500
Capaciteit LC bij gebruik in omsnoering	daN	5000
Capaciteit STF	daN	300
Prijs	€	12,50

METALWORKS



Sjorband met buckle-sluiting. Verpakt op blister. Geschikt voor rails BARA25A en BARA25B.

Order nr.	757572525 €	757575050 €	
Orig. nr.	BAS025A	BAS050A	
Lengte	m	2,5	5,0
Breedte	mm	25	25
Capaciteit (LC)	daN	100	100
Capaciteit (SHF)	daN	50	50
Prijs	€	7,00	4,80

METALWORKS



PP-bindband voor uiteenlopend gebruik en dito kunststof strap. Ideaal voor verpakkingsdoelinden. Rol van 2200m.

Order nr.	757571000 †	
Orig. nr.	PR-W1	
Lengte	m	2200
Breedte	mm	15
Prijs	€	123,00

METALWORKS



Straps voor PP-bindband verpakt per 250 st.

Order nr.	757571010 †	
Orig. nr.	757571010	
Prijs	€	53,50



INRICHTING VAN BEDRIJFSVOERTUIGEN **VOLUME OP MAAT**



VOLLEDIGE CATALOGUS BESCHIKBAAR OP
www.vtc.be

Jerrycans

METALWORKS



Kunststof jerrycan met flexibele tuit. UN gehomologeerd. Niet geschikt voor levensmiddelen. VE = verpakkingseenheid.

Order nr.	756000510	756001006	756002006
Orig. nr.	JERRY5R	JERRY10R	JERRY20R
Capaciteit	5	10	20
VE	10	6	6
Prijs/VE	€ 72,90	€ 62,00	€ 105,00

VTC



Kunststof jerrycan met kraan. Inhoud 10lt. Niet geschikt voor levensmiddelen. Past in jerrycanhouder PTNC10.

Order nr.	815610018
Orig. nr.	TC10L
Prijs	€ 22,50

VTC



Jerrycanhouder. In gelakt ijzer. Geschikt voor TC10L.

Order nr.	815610008
Orig. nr.	PTNC10
Prijs	€ 74,90

VTC



Jerrycanhouder. In gelakt ijzer. Geschikt voor JERRY20M.

Order nr.	815610009
Orig. nr.	PTNC20
Prijs	€ 93,00

Papierrollhouders

VTC



Papierrollhouder geleverd met of zonder papierrol. In gelakt metaal en voorzien van een systeem ter voorkoming van ongewenst afrollen van het papier. Leverbaar in 2 modellen.

Order nr.	940014014	940014015	940014016	940014017
Orig. nr.	PC250E	PC250ES	PC280E	PC280ES
Omschrijving	Papierrollhouder in alu MET papierrol	Papierrollhouder in alu ZONDER papierrol	Papierrollhouder in alu MET papierrol	Papierrollhouder in alu ZONDER papierrol
Gewicht	kg 1,36	kg 0,69	kg 4,13	kg 1,28
Afmetingen (l x b x h)	mm 240 x 90 x 150	mm 240 x 90 x 150	mm 280 x 160 x 210	mm 280 x 160 x 210
Prijs	€ 66,00	€ 56,00	€ 79,00	€ 64,00

VTC



Papierrol apart voor PC250 en PC280.

Order nr.	940001010	815610099
Orig. nr.	CR250	CR280
Voor type	PC250	PC280
Gewicht	kg 0,67	kg 2,85
Afmetingen (l x b x h)	mm 220 x 190 x 0	mm 250 x 250 x 0
Prijs	€ 10,00	€ 24,50

METALWORKS



Metalen papierrollhouder. Muurmodel. Gepoederlakt. Geleverd zonder papierrol.

Order nr.	758621001
Orig. nr.	SHC004
Diameter rol	mm 300
Gewicht	kg 1,20
Afmetingen (l x b x h)	mm 400 x 270 x 0
Prijs	€ 29,00

METALWORKS



Metalen papierrollhouder. Voetmodel. Gepoederlakt. Geleverd zonder papierrol.

Order nr.	758621400
Orig. nr.	SHC014
Diameter rol	mm 300
Gewicht	kg 3,20
Afmetingen (l x b x h)	mm 700 x 480 x 770
Prijs	€ 40,00

Ultrasoonreinigers

METALWORKS



Digitale ultrasoonreiniger met afvoerkraan en timer 1-99 min en temperatuursregeling (tot 80°C). Maakt gebruik van ultrasonische geluidsgolven om alle soorten materiaal te reinigen. Trillingen worden met een hoge frequentie overgebracht aan de reinigingsvloeistof, waardoor de kleinste vuildeeltjes op de meest ontoegankelijke plaatsen worden losgeweekt. De voordelen van ultrasoonreinen:

* Gebruiksgemak: het reinigingsproces heeft minder menselijke interventie nodig.

* Resultaat: precieze reiniging, ook op moeilijk bereikbare plaatsen

* Economisch: kortere reinigingscyclus, minder menselijke interventie nodig

* Milieuvriendelijk: minder reinigingsproducten nodig, beperkt afvalwater

Enkele toepassingen:

* Automotive: Cilinderkoppen, diesel injectie leidingen, brandstofpomp behuizingen, injectoren, cilindervoeringen, uitlaten, ontluchtingsleidingen, compressorleidingen, spiegel onderdelen, sensoren ABS, carburateurs, etc.

* Machines en gereedschappen: Drukvormen, matrijzen, snijgereedschap, schuifmaten, micrometers, meetgereedschappen, frezen, boren, zagen, draaibekers, etc.

* Houtbewerking: Cirkelzagen, zaagbladen, frezen

Vanaf inhoud 60L: reiniger op wielen

Kan gebruikt worden met de universele reiniger WU5

Order nr.	754750070 E	754750071 E	754750072 E	754750073 E	754750074 E	754750075 E	754750076 E
Orig. nr.	UCL010	UCL022	UCL030	UCL060	UCL060T	UCL072	UCL072T
Inhoud	l	10	22	30	60	60	72
Ultrasoon vermogen	W	240	500	500	1000	1200	1500
Verwarming vermogen	W	285	475	475	1500	1500	1500
Totaal vermogen	W	525	975	975	2500	2700	3000
Timer	min	1-99	1-99	1-99	1-99	1-99	1-99
Maximum temperatuur	°C	80	80	80	80	80	80
Frequentie	kHz	40	40	40	28	28	28
Gewicht	kg	10,00	16,50	19,00	65,00	75,00	30,00
Afmetingen inwendig(l x b x h)	mm	300x240x150	500x300x150	500x300x200	500x400x300	500x400x300	600x400x300
Prijs	€	509,00	839,00	1.140,00	2.130,00	2.299,00	2.289,00

METALWORKS

Universele geconcentreerde reiniger. Perfecte ontvetting, reiniging en tijdelijke bescherming tegen roest in één. Bruikbaar voor vele materialen, zoals staal, RVS, non-ferrometaal (koper, nikkel) maar ook voor allerlei kunststoffen en glas, keramiek en alkalibestendig email.

Gebruiksmogelijkheden: De met water mengbare vloeibare reiniger is veelzijdig inzetbaar in zeer verschillende reinigingsprocedures, zoals spuiten (de reiniger is geschikt voor spuiten en laagschuimend), dompelen (geschikt voor ultrageluid), hogedrukstoomstraalreiniging, borstelen/vegen en bodemreinigingsmachines.

Voordelen: uitstekende reinigingswerking, roestende materialen krijgen na reiniging een tijdelijke bescherming tegen roest en krijgen daardoor een langere levensduur, kenmerkende geur, pH-waarde 9,9 +/- 0,5, geen metaalcorrosie, geen indeling volgens bedrijfsveiligheidsverordening



NEW

Order nr.	754753011 E
Orig. nr.	WU5
Inhoud	l
Prijs	€
	5
	49,90



Onderdelenreinigers

METALWORKS



NEW

Onderdelenreiniger 14L wandmodel, inklapbaar. Met reservoir, ingebouwde pomp, metalen flexibel en borstel. Met ingebouwde lamp. 240V, 26W. Kan zowel aan de muur bevestigd worden als staand gebruikt worden. Inklapbaar, neemt weinig plaats in, ideaal om boven de werkbank te bevestigen. Geschikt voor reiniging van kleine mechanische onderdelen, motoronderdelen, etc. Ontvetter "purgasol" apart leverbaar.

Order nr.	754751314 €	
Orig. nr.	CAT140	
Afmetingen werkblad (l x b x h)	mm	560x545x630
Spanning	V	240
Vermogen motor pomp	W	26
Capaciteit	l	14
Gewicht	kg	24,00
Afmetingen (l x b x h)	mm	280 x 560 x 660
Prijs	€	154,00

METALWORKS



19L

Onderdelenreiniger. Tafelmodel met een inhoud van 19lt. Met reservoir, ingebouwde pomp en metalen flexibel. De ontvetter circuleert in de reiniger tot deze wordt afgelaten via de aflaatstop. Met smeltveiligheid tegen ontbranding in de reiniger. Ontvetter "purgasol" apart leverbaar.

Order nr.	754751350 €	
Orig. nr.	CAT135	
Spanning	V	220
Totale inhoud tank	l	19
Minimum inhoud solvent	l	7,5
Maximum inhoud solvent	l	10
Doorstroomsnelheid	l/min	2,7 - 3,3
Gewicht	kg	6,50
Afmetingen (l x b x h)	mm	340 x 430 x 220
Prijs	€	67,00

METALWORKS



75L

Onderdelenreiniger. Voetmodel met een inhoud van 220lt. Met reservoir, ingebouwde vloeistofpomp en metalen flexibel. De ontvetter circuleert in de reiniger tot deze wordt afgelaten via de aflaatstop. Met smeltveiligheid tegen ontbranding in de reiniger. Ontvetter "purgasol" apart leverbaar.

Order nr.	754752222 €	
Orig. nr.	CAT220	
Spanning	V	220
Totale inhoud tank	l	75
Minimum inhoud solvent	l	40
Maximum inhoud solvent	l	50
Doorstroomsnelheid	l/min	2,7 - 3,3
Gewicht	kg	23,00
Afmetingen (l x b x h)	mm	540 x 760 x 880
Prijs	€	159,00

METALWORKS



150L

Onderdelenreiniger. Voetmodel met een inhoud van 150lt. Met reservoir, ingebouwde vloeistofpomp en metalen flexibel. De ontvetter circuleert in de reiniger tot deze wordt afgelaten via de aflaatstop. Met smeltveiligheid tegen ontbranding in de reiniger. Ontvetter "purgasol" apart leverbaar.

Order nr.	754751340 €	
Orig. nr.	CAT340	
Afmetingen werkblad (l x b x h)	mm	560x545x360
Spanning	V	220
Totale inhoud tank	l	150
Minimum inhoud solvent	l	70
Maximum inhoud solvent	l	83
Doorstroomsnelheid	l/min	2,7 - 3,3
Gewicht	kg	42,00
Afmetingen (l x b x h)	mm	540 x 1130 x 890
Prijs	€	234,00

METALWORKS



Professionele staande onderdelenreiniger Type M. Stevige en robuuste plaatstalen constructie. Groot werkblad voor het reinigen van grote en zware onderdelen. Geleverd met een onderhoudsvrije IBS gebreveteerde circulatiepomp, voetpedaalbediening en reinigingsborstel. Zonder reinigingsmiddel of opvangbak. "Purgasol" ontvetter apart beschikbaar.

Order nr. 754753115 €

Orig. nr.		IBSTYPM
Geschikt voor vaten van	l	200
Afmetingen werkblad (l x b x h)	mm	1145x660x900
Belastbaarheid werkblad	kg	150
Spanning	V	230
Frequentie	Hz	50
Gewicht	kg	47,00
Prijs	€	935,00

METALWORKS



Professionele mobiele onderdelenreiniger Type F2. Stevige en compacte plaatstalen constructie. Geleverd met een onderhoudsvrije IBS gebreveteerde circulatiepomp, voetpedaalbediening en reinigingsborstel. Zonder reinigingsmiddel. "Purgasol" ontvetter apart beschikbaar.

Order nr. 754753080 €

Orig. nr.		IBSTYPF2
Geschikt voor vaten van	l	50
Afmetingen werkblad (l x b x h)	mm	800x540x900
Belastbaarheid werkblad	kg	60
Spanning	V	230
Frequentie	Hz	50
Gewicht	kg	43,00
Prijs	€	1.019,00

METALWORKS



Reinigingsborstel voor onderdelenreinigers type M en F2. Zachte of harde borstel beschikbaar.

Order nr. 754753990 € 754753995 €

Orig. nr.		IBSBH	IBSBZ
Omschrijving	l	hard	zacht
Gewicht	kg	1,00	1,00
Prijs	€	15,90	15,90

METALWORKS



Universele borstel met PVC-aansluitingslang voor onderdelenreinigers.

Order nr. 754752225 €

Orig. nr.		CAT220BR
Gewicht	kg	0,13
Prijs	€	6,90

METALWORKS



Special cleaner PURGASOL. Universele reiniger en ontvetter geschikt voor het effectief reinigen van met olie en vet vervuilde producten (pompen, armaturen, motoren, rollagers,...). Voor gebruik in elke werkplaats waar een snelle en gelijkmatige verdamping van de reinigingsvloeistof aangewezen is. Door de geringe oppervlaktenspanning dringt de ontvetter in de kleinste openingen door. Milde geur, Ph-neutraal en niet reactief op metalen. Max. gebruikstemperatuur 61°C. Bussen van 5 en 25 liter voor toepassing in kleine onderdelenreinigers. Vaten van 50 en 200 liter voor gebruik in IBS onderdelenreinigers (geschikt voor recyclage van afgewerkt vat). Staal op aanvraag leverbaar.

Order nr.	Orig. nr.	Inhoud l	Gewicht kg	Prijs €
754753005 €	IBSP5	5	5,00	39,00
754753025 €	IBSP25	25	25,00	99,00
754753500 €	IBSP50	50	1,00	179,00
754753200 €	IBSP200	200	1,00	689,00

METALWORKS



Verfpijstoolreiniger met een uniek pneumatisch bediend reinigingssysteem. Geschikt voor verf op waterbasis en verf op solventbasis. Snel en eenvoudig in gebruik. Reinigt in 1 minuut een compleet verfpijstool met luchtdruk uit verschillende sproeiers in de tank. Volledig onderhoudsvrij. Voorgemonteerd en gebruiksklaar geleverd. Conform de CE en EX normen.

Order nr. 754756030 €

Orig. nr.		KC6000
Gewicht	kg	17,00
Afmetingen (l x b x h)	mm	700 x 380 x 860
Prijs	€	615,00



Zandstraalcabines

METALWORKS



NEW

Mobiele zandstraalketel om o.a. roest en oude laklagen te verwijderen. Inhoud 75L. Dankzij de stevige wielen en handvaten, kan de zandstraler eenvoudig verplaatst worden, ook wanneer hij vol is. Ook de 2.43 m lange slang zorgt voor een goede mobiliteit. Geleverd met trechter en beschermmasker.

Order nr.	754750026 €	
Orig. nr.	CAT020	
Capaciteit	l	75
Lengte slang	m	2,43
Werkdruk en luchtverbruik	4,5 - 8,6 bar (170-700 l/min)	
Gewicht	kg	15,00
Afmetingen (l x b x h)	mm	380 x 780 x 920
Prijs	€	179,00

METALWORKS



NEW

Mobiele zandstraalketel om o.a. roest en oude laklagen te verwijderen. Inhoud 75L. Dankzij de trechtervorm, kan straalmiddel eenvoudig en zonder morsen in de ketel gegoten worden. Dankzij de stevige wielen en handvaten, kan de zandstraler eenvoudig verplaatst worden, ook wanneer hij vol is. Ook de 3 m lange slang zorgt voor een goede mobiliteit. Geleverd met beschermmasker en verwisselbare koppen.

Order nr.	754750025 €	
Orig. nr.	CAT020RA	
Capaciteit	l	75
Lengte slang	m	3
Werkdruk en luchtverbruik	4,5 - 8,6 bar (170-700 l/min)	
Gewicht	kg	16,00
Afmetingen (l x b x h)	mm	420 x 560 x 890
Prijs	€	179,00

METALWORKS



Zandstraalcabine met lamp, tafelform. Stalen cabine met kijkscherm uit verhard glas. Grote zijdeur om gemakkelijk grotere materialen te reinigen. Zware handschoenen zorgen voor bescherming van de handen. Inclusief zandstraalpistool en keramische kopjes. Geschikt voor o.a. glaskorrels, siliciumzand aluminiumoxide.

Order nr.	754751210 €	
Orig. nr.	CAT210	
Afmetingen toegangsdeur (l x b x h)	mm	457x37x455
Maximum werkdruk	bar	8,6
Gewicht	kg	28,00
Afmetingen (l x b x h)	mm	460 x 710 x 690
Prijs	€	149,00

METALWORKS



Zandstraalcabine, voetmodel. Voorzien van afvoeropening voor het verwijderen van het sableerzand. Stalen cabine met kijkscherm uit verhard glas. Grote deur om gemakkelijk grotere materialen te reinigen. Zware handschoenen zorgen voor bescherming van de handen. Inclusief zandstraalpistool en 4 pistooltips (4mm, 5mm, 6mm en 7mm). Geschikt voor o.a. glaskorrels, siliciumzand aluminiumoxide.

Order nr.	754751410 €	
Orig. nr.	CAT410	
Afmetingen toegangsdeur (l x b x h)	mm	565x37x482
Maximum werkdruk	bar	8,6
Gewicht	kg	48,00
Afmetingen (l x b x h)	mm	900 x 570 x 1400
Prijs	€	354,00

METALWORKS



NEW

Zandstraalcabine voor middelgrote werkzaamheden, 340-420L met stofafzuiging. 240V Geleverd met hoge kwaliteit latex handschoenen, verlichting in afzonderlijke behuizing, beschermglas en vervangbare beschermfolie, inclusief 5 reserve films voor verlichting en 5 voor raam, afzuiging met microfilter, blaaspistool met keramische koppen 6,6,7,7 mm. Max. werkdruk 8.6 bar. Drukregelaar met manometer. Snel en gemakkelijk te laden door 2 zijdeuren + 1 frontdeksel. Met voetpedaal voor eenvoudige bediening. Meer info & foto's: zie www.vynckier.biz.

Order nr.	754751442 €	
Orig. nr.	CAT420	
Luchtverbruik @ 8,5 bar	l/min	35
Spanning	V	240
Capaciteit	l	340-420
Maximum werkdruk	bar	8,6
Luchtverbruik @ 8 bar	l/min	340
Gewicht	kg	122,00
Afmetingen (l x b x h)	mm	900 x 1300 x 1700
Prijs	€	999,00

METALWORKS



NEW

Zandstraalmiddel in kunststof container met schroefdoop.

ALS15 en ALS120: Aluminium silicaat voor het verwijderen van roest, verf en schilfers, alsook voor de oppervlaktebehandeling van gevels, glas, enz. Aanbevolen werkdruk 6-7 bar. OPGELET: niet geschikt voor zandstraalcabines.

ALM25: Straalzand 2 – Natuurlijk straalzand, snelle actie en lage stofproductie. Geschikt voor vrij zandstralen alsook voor zandstraalcabines. Hoge densiteit, wat de verspreiding van het materiaal limiteert en het afvalvolume reduceert. Aanbevolen werkdruk 7-8 bar.

Order nr.	96020300 €	96020706 €	96020904 €
Orig. nr.	ALS15	ALS120	ALM25
Inhoud	l	5	20
Werkdruk	bar	6-7	7-8
Korrelgrootte	mm	0.20.5	0.20.6
Gewicht	kg	8,00	26,00
Prijs	€	15,50	41,50



COMPRESSOREN

p.564



NEW

Professionele zandstraalcabine 990L, met stofafzuiging. 240V, 110W. Geleverd met hoge kwaliteit latex handschoenen, 4 fluorescerende werklampen van 26 Watt, 5 beschermfolies voor raam en lampen, afzuiging met microfilter, blaaspistool met keramische koppen 6,6,7,7 mm. Totale binnenafmetingen: 107 x 88 x 82,5 cm. Max werkdruk 8,6 bar. Drukregelaar met manometer. Met voetpedaal voor eenvoudige bediening. Meer info & foto's: zie www.vynckier.biz.

Order nr.	754751990 €	
Orig. nr.	CAT990	
Spanning	V	240
Capaciteit	l	990
Binnenafmetingen (l x b x h)	mm	1070x880x825
Vermogen	W	1100
Maximum werkdruk	bar	8,6
Luchtverbruik @ 8 bar	l/min	680
Gewicht	kg	160,00
Afmetingen (l x b x h)	mm	1240 x 1320 x 1760
Prijs	€	1.249,00

METALWORKS



NEW

Beschermkap voor zandstralen.

Order nr.	754750020 €	
Orig. nr.	CATSBH	
Gewicht	kg	5,00
Afmetingen (l x b x h)	mm	470 x 300 x 560
Prijs	€	20,50

Olieopvang

METALWORKS



NEW

Olieopvangpan 15 liter.

Order nr.	724561004 €	
Orig. nr.	ODP15	
Gewicht	kg	1,20
Afmetingen (l x b x h)	mm	560 x 480 x 460
Prijs	€	13,50

METALWORKS



NEW

Vloeistofafzuiger handbediend en pneumatisch. Capaciteit 7.3 liter. Een schone, snelle en eenvoudige manier om allerlei vloeistoffen af te zuigen, geschikt voor het verwijderen van een groot aantal vloeistoffen: motorolie, transmissie vloeistof, versnellingsbakolie, koelvloeistof, remvloeistof en andere. Bevat 1,5 m flexibele slang en twee stijve buizen voor motorolie. De zelfsluitende klep voorkomt dat de vloeistof overloopt. Gemaakt van duurzame polyethyleen bestendig tegen huishoudelijke en automotive chemicaliën.

Order nr.	724561008	
Orig. nr.		OD7PN
Capaciteit	l	7,3
Gewicht	kg	10,50
Prijs	€	97,90

METALWORKS



NEW
30L

Olieopvang unit op wielen met een capaciteit van 30 liter en verstelbare hoogte.

Order nr.	724561006	
Orig. nr.		OD30PE
Capaciteit	l	30
Hoogte minimum	mm	680
Hoogte maximum	mm	1650
Verstelbare hoogte	mm	680-1650
Diameter trechter	mm	420
Gewicht	kg	5,50
Prijs	€	69,00

METALWORKS



NEW
65L

Olieopvangunit met pneumatische lediging. Het vat is heel eenvoudig en proper te ledigen aan de hand van luchtdruk. Het oliepeil kan afgelezen worden op het vat. Met 2 vaste en 2 zwenkbare wielen voor uitstekende mobiliteit. Niet geschikt voor benzine of diesel.

Order nr.	724561001	
Orig. nr.		OD68
Capaciteit	l	68
Hoogte minimum	mm	1170
Hoogte maximum	mm	1780
Verstelbare hoogte	mm	1170-1780
Diameter trechter	mm	290
Gewicht	kg	23,00
Afmetingen (l x b x h)	mm	960 x 440 x 420
Prijs	€	179,00

METALWORKS



NEW
65L
REFILL
SUCTION
FLOW DRAINING

Multifunctionele olie opvang- en afzuigunit met een capaciteit van 65 + 9 liter en een verstelbare hoogte van 130-185cm. 2 vaste en 2 zwenkwielen voor uitstekende mobiliteit.

3 functies:

1. Oliedrainage onder auto
2. Olie afzuigen (bijvoorbeeld uit motorkap)
3. Hervullen: Er kan 9 liter afgezogen olie opgeslagen worden in de tussenkamer, bijvoorbeeld ter inspectie. Deze kan dan opnieuw in het voertuig gebracht worden aan de hand van luchtdruk. Niet geschikt voor benzine of diesel.

Order nr.	724561003	
Orig. nr.		ODC65
Capaciteit	l	65
Capaciteit tussenkamer	l	9
Verstelbare hoogte	mm	1300-1850
Lengte trechter	mm	530
Gewicht	kg	32,00
Afmetingen (l x b x h)	mm	480 x 500 x 1850
Prijs	€	279,00

Montagestoelen

METALWORKS



Montagestoelje op 5 PU-wielen. Verstelbaar in de hoogte met cilinder. Met magneetvakje in de basis.

Order nr.	756183650 €
Orig. nr.	MS365
Minimum-maximum hoogte	mm 440/555
Diameter basis	mm 440
Diameter zijje	mm 365
Gewicht	kg 6,60
Prijs	€ 49,90

METALWORKS



Klapstoelje. Met PP wielen met schokabsorberende PE-laag. Oplooibaar in 3 delen tot klapstoelje.

Order nr.	756203001 €
Orig. nr.	MTB3D
Diameter wiel	mm 60
Maximum laadcapaciteit	kg 110
Hoogte bed	mm 105
Gewicht	kg 6,70
Afmetingen (l x b x h)	mm 1020 x 400 x 470
Prijs	€ 49,90

METALWORKS



Montagestoel uit harde kunststof. Met zachte hoofdsteun. Wielen in zwart pvc met zachtlopende grijze PU-laag.

Order nr.	756203002 €
Orig. nr.	MTB10
Minimum-maximum hoogte	mm 50/115
Diameter wiel	mm 75
Maximum laadcapaciteit	kg 130
Gewicht	kg 4,80
Afmetingen (l x b x h)	mm 1010 x 490 x 120
Prijs	€ 39,90

Garagestands

METALWORKS



Set van 2 garagestands. Met tandlat. Opmerking : Model 12 T is enkel geschikt voor export buiten de EU.

Order nr.	754753030 €	754756060 €	754751212 €
Orig. nr.	CAGS3T	CAGS6T	CAGS12T
Capaciteit	T 3	6	12
Hoogte minimum	mm 288	406	482
Hoogte maximum	mm 425	629	762
Voet	mm 190x216	254x292	305x317
Tandlat	mm 267x100	366x120	467x162
Gewicht	kg 8,50	13,90	30,00
Prijs	€ 12,50	22,50	42,50

METALWORKS



NEW
CE

Professionele zware assteen 25 ton met versterkte kolom en grote, stabiele grondplaat. CAGS256TH met extra groot werkbereik. CNC-gedraaide glij-as met matzwarte krasbestendige afwerking. Precisie borgpen met 2 inlegsleuven en veiligheidsketting. Met handgreep. CE conform. Geleverd per stuk.

Order nr.	754751227 €	754751225 €
Orig. nr.	CAGS25T	CAGS25TH
Capaciteit	T 25	25
Hoogte minimum	mm 415	675
Hoogte maximum	mm 640	1050
Gewicht	kg 23,50	33,50
Afmetingen (l x b x h)	mm 38 x 380 x 440	380 x 380 x 710
Prijs	€ 129,00	174,00

Motorstands

METALWORKS



Motorsteun. Met 360° draaibare kop in 8 posities, vastzetbaar.

Order nr.	758621600 €
Orig. nr.	CAT1000
Capaciteit	kg 500
Gewicht	kg 21,00
Afmetingen (l x b x h)	mm 750 x 850 x 900
Prijs	€ 71,00



Oprolhaspels

METALWORKS



HPM

Manuele oprolhaspel voor perslucht. Metalen behuizing en unieke HPM slang van 30 meter. Met kabelblokkering, oprolhendel en draaibaar plateau.

Voordelen van de HPM-slang :

Combineert voordelen van PVC en rubber in 1 uniek product :

1. Superieure buigkracht voorkomt kreuken.
2. Resistent tegen olie, warmte, ozon en schuren.
3. Ook in koude omstandigheden nog flexibel.
4. Rolt af zonder te krullen.
5. Heel licht.
6. Werktemperatuur : -10°C -60°C

Order nr.	756200730 €	
Orig. nr.	HAL01430M	
Lengte kabel	m	30 + 0,5
Type oprolhaspel	drukvlucht	
Aansluiting	inch	1/4
Maximum druk	bar	12
Inwendige diameter leiding	mm	6
Kwaliteit kabel	HPM	
Gewicht	kg	10,00
Afmetingen (l x b x h)	mm	360 x 180 x 380
Prijs	€	71,90

METALWORKS



PVC

Stevige automatische oprolhaspel voor perslucht. Behuizing in polypropyleen. Slang in soepele pvc. 180° links-rechts beweegbaar op muurbevestiging. Met kabelgeleiding dmv boven- en onderrol. Op- en afrolbaar met een klikmechanisme. Automatische terugkeer door kort aantrekken. Werktemperatuur: 0° tot 60°C.

Order nr.	756200705 €	
Orig. nr.	HAL00808	
Lengte kabel	m	8 + 0,5
Muurbevestiging	✓	
Type oprolhaspel	drukvlucht	
Aansluiting	inch	1/4
Maximum druk	bar	12
Inwendige diameter leiding	mm	8
Kwaliteit kabel	PVC	
Gewicht	kg	4,00
Afmetingen (l x b x h)	mm	360 x 180 x 380
Prijs	€	62,90

METALWORKS



PVC

Stevige automatische oprolhaspel voor perslucht. Behuizing in polypropyleen. Slang in soepele pvc. 180° links-rechts beweegbaar op muurbevestiging. Met kabelgeleiding dmv boven- en onderrol. Op- en afrolbaar met een klikmechanisme. Automatische terugkeer door kort aantrekken. Werktemperatuur: 0° tot 60°C.

Order nr.	756200707 €	
Orig. nr.	HAL01015	
Lengte kabel	m	15 + 0,5
Muurbevestiging	✓	
Type oprolhaspel	drukvlucht	
Maximum druk	bar	20
Inwendige diameter leiding	mm	10
Kwaliteit kabel	PVC	
Ingang/uitgang	inch	3/8
Gewicht	kg	9,00
Afmetingen (l x b x h)	mm	410 x 200 x 400
Prijs	€	84,90

METALWORKS



PVC

Stevige automatische oprolhaspel voor perslucht. Behuizing in polypropyleen. Slang in soepele pvc. 180° links-rechts beweegbaar op muurbevestiging. Met kabelgeleiding dmv boven- en onderrol. Op- en afrolbaar met een klikmechanisme. Automatische terugkeer door kort aantrekken. Werktemperatuur: 0° tot 60°C.

Order nr.	756200720 ^E	
Orig. nr.	HAL03820	
Lengte kabel	m	20 + 0,5
Muurbevestiging	✓	
Type oprolhaspel	drukluft	
Maximum druk	bar	20
Inwendige diameter leiding	mm	10
Kwaliteit kabel	PVC	
Ingang/uitgang	inch	3/8
Gewicht	kg	8,20
Afmetingen (l x b x h)	mm	460 x 215 x 430
Prijs	€	103,00

METALWORKS



NEW

HPM

Stevige automatische oprolhaspel voor perslucht. Groot luchtdebiet door 13mm slangdiameter (binnendiameter) en 1/2" aansluiting. Behuizing in impactbestendig polypropyleen. Sterke, soepele HPM Slang met uniek gebruiksgemak. 180° links-rechts beweegbaar op muurbeugel. Slanggeleiding dmv boven- en onderrol. Op- en afrolbaar met een klikmechanisme. Automatische terugkeer door kort aantrekken. Werktemperatuur: -10° tot 60°C.

Unieke voordelen van de HPM-slang :

Combineert voordelen van PVC en rubber in 1 product :

1. Superieure buigkracht voorkomt kreuken.
2. Resistent tegen olie, warmte, ozon en schuren.
3. Ook in koude omstandigheden nog flexibel.
4. Rolt af zonder te krullen.
5. Heel licht.
6. Werktemperatuur : -10°C tot 60°C

Order nr.	756200745 ^E	
Orig. nr.	HAL01215	
Lengte kabel	m	15+0.5
Type oprolhaspel	drukluft	
Diameter inwendig	mm	13
Maximum druk	bar	20
Kwaliteit kabel	HPM	
Gewicht	kg	10,00
Afmetingen (l x b x h)	mm	420 x 230 x 490
Prijs	€	109,00

METALWORKS



PVC

Vaste, automatische oprolhaspel voor montage op muur, plafond of vloer. Basis en kabelgeleiding in staal, drum in stevig PVC. Open haspel met automatische retour van de slang. Geleiding instelbaar in 3 posities voor optimale plaatsing. 15m HPM slang met 3/8" in- en uitgang. voorzien van aansluitslang van 0,9m. Voordelen van de HPM-slang :

Combineert voordelen van PVC en rubber in 1 uniek product :

1. Superieure buigkracht voorkomt kreuken.
2. Resistent tegen olie, warmte, ozon en schuren.
3. Ook in koude omstandigheden nog flexibel.
4. Rolt af zonder te krullen.
5. Heel licht.
6. Werktemperatuur : -10°C -60°C

Order nr.	756200735 ^E	
Orig. nr.	HAL03815V	
Lengte kabel	m	15 + 0,5
Muurbevestiging	✓	
Type oprolhaspel	drukluft	
Maximum druk	bar	20
Inwendige diameter leiding	mm	10
Kwaliteit kabel	HPM	
Ingang/uitgang	inch	3/8
Gewicht	kg	7,50
Afmetingen (l x b x h)	mm	365 x 175 x 539
Prijs	€	74,00

aircraft



PU

Automatische oprolhaspel voor perslucht met 15 meter vezelversterkte PU-slang. Behuizing in polypropyleen. 180° links-rechts beweegbaar op muurbevestiging. Op- en afrolbaar met een klikmechanisme. Automatische terugkeer door kort aantrekken. Werktemperatuur : -5° tot 40°C.

Order nr.	712105200 ^T	
Orig. nr.	2105200	
Lengte kabel	m	15 + 01
Muurbevestiging	✓	
Type oprolhaspel	drukluft	
Diameter inwendig	mm	10
Aansluiting	inch	3/8
Maximum druk	bar	15
Inwendige diameter leiding	mm	10
Kwaliteit kabel	PU	
Ingang/uitgang	inch	3/8
Maximum luchtverbruik	bar	15
Werktemperatuur	°C	-5 - +40
Gewicht	kg	6,50
Afmetingen (l x b x h)	mm	230 x 420 x 490
Prijs	€	249,00

METALWORKS



Draagbare kabelhaspel met unieke automatische oprolfunctie. Uw verlengkabel ligt nooit meer in de weg, maar wordt steeds teruggerold op de haspel. Met kabelblokkering, thermische beveiliging en slagvaste behuizing. Perfecte kabelgeleiding. Flexibele rubberkabel H07RN-F die weer-, vet- en oliebestendig is. Regenwaterdicht. Antislipvoeten op 6 plaatsen. Ideaal voor op de werf. EN 61242, VDE, KEMA, CEBEC. Met Schuko-combi strekker.

Order nr.	756200630	
Orig. nr.	HAE31520MO	
Spanning	V	230
Lengte kabel	m	20 + 2
Toegelaten vermogen opgerold	W	720
Toegelaten vermogen ontrol	W	3120
Kabel	mm ²	3x1,5
Type oprolhaspel	elektrische kabel	
Certificaat	VDE, GS, CE	
Gewicht	kg	6,00
Afmetingen (l x b x h)	mm	500 x 310 x 290
Prijs	€	102,00

METALWORKS



Automatische kabelhaspel met elektriciteitskabel. Behuizing in onbreekbaar polypropyleen. Geleverd met 2 stekkers. Flexibele rubberkabel HN07RN-F die weer-, vet- en oliebestendig is (conform de CEI 20-35 norm). Op 180° links-rechts beweegbare muurbevestiging. Met kabelbegeleiding dmv boven- en onderrol. Op- en afrolbaar met een klikmechanisme. Automatische terugkeer door kort aantrekken. Met thermische beveiliging. CE en IP42 conform. Met Schuko-combi strekker.

Order nr.	756200625	
Orig. nr.	HAE31508	
Spanning	V	230
Lengte kabel	m	8 + 1
Toegelaten vermogen opgerold	W	1000
Toegelaten vermogen ontrol	W	2000
Kabel	mm ²	3x1,5
Muurbevestiging	✓	
Type oprolhaspel	elektrische kabel	
Certificaat	VDE, GS, CE	
Gewicht	kg	4,50
Afmetingen (l x b x h)	mm	280 x 160 x 305
Prijs	€	55,90

METALWORKS



Automatische kabelhaspel met elektriciteitskabel. Behuizing in onbreekbaar polypropyleen. Geleverd met 2 stekkers. Flexibele rubberkabel HN07RN-F die weer-, vet- en oliebestendig is (conform de CEI 20-35 norm). Op 180° links-rechts beweegbare muurbevestiging. Met kabelbegeleiding dmv boven- en onderrol. Op- en afrolbaar met een klikmechanisme. Automatische terugkeer door kort aantrekken. Met thermische beveiliging. CE en IP42 conform. Met Schuko-combi strekker.

Order nr.	756200605	
Orig. nr.	HAE31515	
Spanning	V	230
Lengte kabel	m	15 + 1
Toegelaten vermogen opgerold	W	1000
Toegelaten vermogen ontrol	W	2000
Kabel	mm ²	3x1,5
Muurbevestiging	✓	
Type oprolhaspel	elektrische kabel	
Certificaat	VDE, GS, CE	
Gewicht	kg	5,80
Afmetingen (l x b x h)	mm	320 x 180 x 335
Prijs	€	92,90

METALWORKS



Automatische kabelhaspel met elektriciteitskabel. Behuizing in onbreekbaar polypropyleen. Geleverd met 2 stekkers. Flexibele rubberkabel HN07RN-F die weer-, vet- en oliebestendig is (conform de CEI 20-35 norm). Flexibele kabel, die weer-, vet- en oliebestendig is. Op 180° links-rechts beweegbare muurbevestiging. Met kabelbegeleiding dmv boven- en onderrol. Op- en afrolbaar met een klikmechanisme. Automatische terugkeer door kort aantrekken. Met thermische beveiliging. CE en IP42 conform. Met Schuko-combi strekker.

Order nr.	756200620	
Orig. nr.	HAE31520	
Spanning	V	230
Lengte kabel	m	20 + 1
Toegelaten vermogen opgerold	W	1000
Toegelaten vermogen ontrol	W	2000
Kabel	mm ²	3x1,5
Muurbevestiging	✓	
Type oprolhaspel	elektrische kabel	
Certificaat	VDE, GS, CE	
Gewicht	kg	6,50
Afmetingen (l x b x h)	mm	450 x 210 x 440
Prijs	€	102,00

METALWORKS



Automatische kabelhaspel met elektriciteitskabel. Behuizing in onbreekbaar polypropyleen. Geleverd met 2 stekkers. Flexibele rubberkabel HN07RN-F die weer-, vet- en oliebestendig is (conform de CEI 20-35 norm). Op 180° links-rechts beweegbare muurbevestiging. Met kabelbegeleiding dmv boven- en onderrol. Op- en afrolbaar met een klikmechanisme. Automatische terugkeer door kort aantrekken. Met thermische beveiliging. CE en IP42 conform. Met Schuko-combi strekker.

Order nr.	756202520 E	
Orig. nr.	HAE32520	
Spanning	V	230
Lengte kabel	m	20 + 1
Toegelaten vermogen opgerold	W	1600
Toegelaten vermogen ontrollend	W	3200
Kabel	mm ²	3x2,5
Muurbevestiging	✓	
Type oprolhaspel	elektrische kabel	
Certificaat	VDE, GS, CE	
Gewicht	kg	10,00
Afmetingen (l x b x h)	mm	450 x 210 x 440
Prijs	€	169,00

METALWORKS



Paar stekkers voor montage op HAE-haspels (M+F).

Order nr.	891565123 E	
Orig. nr.	BLSTM	
Gewicht	kg	0,20
Prijs	€	12,50

METALWORKS



Automatische kabelhaspel met elektriciteitskabel en ontkoppelbare LED-lamp (400 lumen). Behuizing in onbreekbaar polypropyleen. Geleverd met 2 stekkers. Oliebestendige rubber kabel HN07RN-F (conform de CEI 20-35 norm). Op 180° links-rechts beweegbare muurbevestiging. Met kabelbegeleiding dmv boven- en onderrol. Op- en afrolbaar met een klikmechanisme. Automatische terugkeer door kort aantrekken. CE en IP42 conform. Met Schuko-combi strekker.

Order nr.	756200626 E	756200627 E	756200628 E	
Orig. nr.	HAZ31508	HAZ31515	HAZ31520	
Spanning	V	230	230	
Lengte kabel	m	8 + 0,5	15 + 0,5	20 + 0,5
Toegelaten vermogen opgerold	W	1000	1000	1000
Toegelaten vermogen ontrollend	W	2000	2000	2000
Kabel	mm ²	3x1,5	3x1,5	3x1,5
Muurbevestiging	✓			
Type oprolhaspel	elektrische kabel			
Capaciteit	lumen	400	400	400
Gewicht	kg	6,00	6,00	6,50
Afmetingen (l x b x h)	mm	280 x 160 x 305	320 x 180 x 335	450 x 210 x 440
Prijs	€	95,00	127,00	143,00

METALWORKS



Super krachtige LED looplamp met kabel. 400 lumen fel witte lichtopbrengst zorgt voor voldoende licht in alle omstandigheden. Brede lichtbundel 120° die het ganse gezichtsveld bereikt. 12 SMD LEDs gekenmerkt door lange levensduur door lage opwarming. Met krachtige rugmagneet en 360° draaibare, onbreekbare nylon haak bovenaan. Werkt via 230V netstroom met kabel H05RNF 3 meter. Onbreekbare cover uit polycarbonaat. Anti-slip handvat. Verkocht per 8 stuks in een Metalworks display.

Order nr.	801106045 E	
Orig. nr.	WLT400	
Spanning	V	230
Lichtsterkte	lumen	400
Maximum lengte	mm	3000
Prijs	€	24,50



Motorhangers

METALWORKS



Motorhanger cap 450 kg. Passend op elk type garagekraan met hendel om de last te verdelen in langsrichting. Niet CE gekeurd, enkel geschikt voor export buiten EU.

Order nr.	754751500 €	
Orig. nr.	CAT1500	
Capaciteit	kg	450
Gewicht	kg	5,50
Afmetingen (l x b x h)	mm	445 x 64 x 190
Prijs	€	32,90

Fleskriks

METALWORKS



Hydraulische fleskrik. Met schroefvijzel en overbelastingsventiel. Modellen tot en met 5 T worden geleverd in kunststof opbergdoos. Model 30 T zonder schroefvijzel.

Order nr.	754751103	754751105	754751108
Orig. nr.	CATM11030	CATM11050	CATM11080
Capaciteit	T	3	5
Hoogte minimum	mm	194	216
Hoogte maximum	mm	372	413
Koers	mm	118	127
Uitdraaibaar (vijzel)	mm	60	70
Prijs	€	18,90	30,90

Order nr.	754751112	754751120	754751300
Orig. nr.	CATM11120	CATM11200	CATM11300
Capaciteit	T	12	20
Hoogte minimum	mm	230	242
Hoogte maximum	mm	445	452
Koers	mm	155	150
Uitdraaibaar (vijzel)	mm	60	60
Prijs	€	39,90	39,90

Rolkriks

METALWORKS



2T

PVC KOFFER

COMPACT

Hydraulische rolkrik met capaciteit 2 ton. Metalen wielen en handige pvc draagbeugel op de krik. Basismodel in handige pvc-koffer.

Order nr.	754752220 €	
Orig. nr.	CATM200	
Capaciteit	T	2
Hoogte minimum	mm	130
Hoogte maximum	mm	380
Hefhoogte	mm	250
Gewicht	kg	12,00
Prijs	€	48,50

METALWORKS



2T

PVC KOFFER

LAAG PROFIEL

Hydraulische rolkrik voor lage voertuigen met capaciteit 2 ton. Met gietijzeren wielen en draagbeugel op de krik. Semi-professioneel gebruik. In handige PVC koffer.

Order nr.	754752221 €	
Orig. nr.	CAT2L	
Capaciteit	T	2
Hoogte minimum	mm	85
Hoogte maximum	mm	330
Hefhoogte	mm	245
Gewicht	kg	11,00
Prijs	€	45,50

METALWORKS



2,5T

PROFESSIONEEL

ALU CHASSIS

Hydraulische rolkrik capaciteit 2,5 ton. Licht en gemakkelijk draagbaar door aluminium chassis en wielen. Solide basis uit plaatstaal geschikt voor dagelijks gebruik. Met alu handvat op het chassis. Professioneel toestel.

Order nr.	754752262 €	
Orig. nr.	CAT25ALU	
Capaciteit	T	2,5
Hoogte minimum	mm	100
Hoogte maximum	mm	460
Hefhoogte	mm	360
Gewicht	kg	26,00
Afmetingen (l x b x h)	mm	650 x 292 x 170
Prijs	€	154,00

METALWORKS



2,5T

LAAG PROFIEL

Hydraulische rolkrik - Cap. 2,5T. Extra laag profiel. Voor professioneel gebruik. Gietijzeren wielen en plaatstalen chassis.

Order nr.	754752260 €	
Orig. nr.	CAT25TL	
Capaciteit	T	2,5
Hoogte minimum	mm	89
Hoogte maximum	mm	457
Hefhoogte	mm	368
Gewicht	kg	36,00
Prijs	€	112,00

METALWORKS



3T

QUICKLIFT

Hydraulische rolkrik - Cap. 3.0T. Met quicklift voetpedaal. Stevige gietijzeren wielen en rubber dop. Professioneel gebruik.

Order nr.	754753000 €	
Orig. nr.	CATM300T	
Capaciteit	T	3
Hoogte minimum	mm	145
Hoogte maximum	mm	520
Hefhoogte	mm	375
Quicklift pedaal		✓
Gewicht	kg	39,00
Prijs	€	112,00

METALWORKS



LAAG PROFIEL

SPEED PUMP

LANGE UITBOUW



speed pump

Hydraulische garagekrik met extra lage en lange uitbouw. Zwaar frame met extra steunwiel middenin voor eenvoudig verplaatsen. Grote en geruisloze gecoat PU wielen en rubber dop. Met quick lift voetpedaal.

Order nr.	754752261 €	
Orig. nr.	CAT2TL	
Capaciteit	T	2
Hoogte minimum	mm	75
Hoogte maximum	mm	510
Hefhoogte	mm	435
Quicklift pedaal		✓
Gewicht	kg	42,00
Prijs	€	229,00

METALWORKS



3T

SPEED PUMP

LAAG PROFIEL

LANGE UITBOUW

speed pump

Hydraulische garagekrik met extra lage en lange uitbouw. Zwaar frame met extra steunwiel middenin voor eenvoudig verplaatsen. Grote en geruisloze gecoate PU wielen en rubber dop. Met quick lift voetpedaal.

Order nr.	754752270 €	
Orig. nr.	CAT3TLL	
Capaciteit	T	3
Hoogte minimum	mm	140
Hoogte maximum	mm	525
Hefhoogte	mm	385
Quicklift pedaal		✓
Gewicht	kg	55,00
Prijs	€	307,00

METALWORKS



10T

Zware rolkrik met capaciteit van 10 Ton. Met quick-lift pedaal en grote gietijzeren wielen.

Order nr.	754751000 €	
Orig. nr.	CATM1000N	
Capaciteit	T	10
Hoogte minimum	mm	160
Hoogte maximum	mm	560
Hefhoogte	mm	400
Quicklift pedaal		✓
Gewicht	kg	145,00
Afmetingen (l x b x h)	mm	1640 x 480 x 260
Prijs	€	599,00

NEW 20T 40T 60T

HYDROPNEUMATISCH

METALWORKS

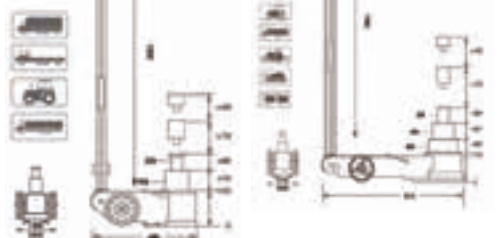

Hydropneumatische rolkriks 40T en 60T. Mobiele garagekriks voor het heffen van vrachtwagens, tractoren, bussen,... met capaciteit 40 of 60 ton. Door de geringe basishoogte is het model HPK2040L ook geschikt voor voertuigen met lage wielen. Hardverchroomde cilinder met lange levensduur wordt geleverd met 2 extensiestukken (75mm en 45mm) voor hogere hefhoogtes. Hoogkwalitatieve rubber dichtingen en olie 'made in USA' (Dow Corning) zijn perfect op elkaar afgestemd, voor een langdurig blijvende smering van de krik. Hendel voor automatische bediening is vergrendelbaar in 3 standen. Bedieningsknop in roestvast staal, met trage slijtage als gevolg. Werktemperatuur: -25°C tot +50°C. Met overbelastingsventiel. CE conform.

Order nr.	754752286 €		754752292 €	
Orig. nr.	HPK2040L		HPK204060	
Hoogte minimum	mm	150	mm	175
Hoogte maximum	mm	409	mm	542
Capaciteit niveau 1	T	40	T	60
Capaciteit niveau 2	T	20	T	40
Capaciteit niveau 3	T	20	T	20
Gewicht	kg	40,00	kg	73,00
Prijs	€	879,00	€	1.369,00

METALWORKS



22T

HYDROPNEUMATISCH

Hydraulisch-pneumatische rolkrik met capaciteit 22 T. Door aansluiten op compressor wordt de hoge hefcapaciteit bereikt. geleverd met 3 verlengstukken voor een hefhoogte tot 448mm. Grote rubbergecoate wielen. CE conform.

Order nr.	754750022 €	
Orig. nr.	CAT822	
Capaciteit	T	22
Hoogte minimum	mm	228
Hoogte maximum	mm	448
Hefhoogte	mm	220
Drukvlucht		✓
Gewicht	kg	40,00
Afmetingen (l x b x h)	mm	660 x 360 x 280
Prijs	€	345,00

Transmissiekriks

METALWORKS



0,5T

Transmissiekrik op wielen. Capaciteit 500 kg. Met pedaal.

Order nr.	754750500 €	
Orig. nr.	CAT755	
Capaciteit	kg	500
Hoogte minimum	mm	1100
Hoogte maximum	mm	1900
Gewicht	kg	32,00
Afmetingen (l x b x h)	mm	570 x 570 x 1100
Prijs	€	199,00

Kolomvijzels

METALWORKS



NEW

2T

Multifunctionele kolomvijzel 2 ton voor het snel optillen van bvb auto's, grasmaaiers, tractoren, werktuigen,.... Licht en direct inzetbaar in alle omstandigheden. Onderhoudsarm. Kan ook liggend toegepast worden voor het duwen of trekken van lasten. Groot werkbereik: 130 tot 1325mm. Met stabiele voet, veiligheidspal en vaste opklapbare hendel. CE conform.

Order nr.	758601032 €	
Orig. nr.	HNFJ2T	
Capaciteit	kg	2000
Hoogte minimum	mm	130
Hoogte maximum	mm	1325
Gewicht	kg	13,00
Afmetingen (l x b x h)	mm	240 x 140 x 1540
Prijs	€	122,00

Uitdeuksets

METALWORKS



Hydraulische uitdeukset 10T. Compleet met handpomp, hydraulische slang, drukcilinder, spreider (0,5T), opzet- en verlengstukken.

Met pvc-koffer uitgerust met wielen voor een gemakkelijk transport.

Order nr.	754751110 €	
Orig. nr.	CATM10CLIP	
Capaciteit	T	10
Gewicht	kg	32,00
Prijs	€	159,00

METALWORKS



Stukken CATM10CLIP.

Order nr.	Orig. nr.	Omschrijving	Prijs €
998140013 €	CATM10PNR40	pomp 10T (zonder slang)	69,50
754751131 €	CATM10RAM	duwcilinder 10T	49,00
998140032 €	CATRAM4TS	duwcilinder 4T	47,50
998140007 €	CAT80411	schaar - spreider 4T/10T	32,00
998140005 €	CATM4/10-NEW	snelkoppeling 1/2" M. universeel	5,50
998140030 €	CATM4/10	snelkoppeling 1/2"-1" M+F (2 dlg)	7,20

Werkplaatskranen

METALWORKS



dodemansventiel



Garagekraan capaciteit 1ton. Oplooibaar model voor eenvoudig opbergen. Draaibare achterwielen en stevige metalen topwielen. Manueel bediende hydraulische cilinder met overbelastingsventiel. Arm met 4 lengte posities. Daalventiel met dodemansknop. CE-conform.

Order nr.	754756100 €	
Orig. nr.	CAT610	
Capaciteit	T	1
Helfbereik	mm	0-1800
Gewicht	kg	72,00
Afmetingen (l x b x h)	mm	1470 x 1190 x 2150
Prijs	€	279,00



METALWORKS



Zwaar uitgevoerde garagekraan met capaciteit 1 ton. Groot stalen chassis laat een hoge hefhoogte toe tot 2320 mm. Hefarm met verschillende lengteposities. Opplooibaar voor gemakkelijk stockeren. Draaibare achterwielen en zware volmetalen topwielen. Hydraulische cilinder met overbelastingsventiel. CE-conform.

Order nr.	754756120 €	
Orig. nr.	CAT6100T	
Capaciteit	T	1
Hefbereik	mm	250-2320
Gewicht	kg	122,00
Afmetingen (l x b x h)	mm	1640 x 510 x 2320
Prijs	€	565,00

METALWORKS



Garagekraan 2 ton. Plooibaar model. Met draaibare achterwielen. Stevige metalen topwielen. Hydraulische cilinder met overbelastingsventiel. Arm met 4 posities. Daalventiel met dodemansknop. CE-conform.

Order nr.	754756200 €	
Orig. nr.	CAT620	
Capaciteit	T	2
Hefbereik	mm	0-1800
Gewicht	kg	87,50
Afmetingen (l x b x h)	mm	1750 x 1020 x 2300
Prijs	€	349,00

METALWORKS



Hydraulische fleskrik, lang model. Met overbelastingsventiel. Geschikt voor garagekranen CAT610/ CAT620.

Order nr.	754756161 €	754756262 €
Orig. nr.	CATRAM610C	CATRAM620
Capaciteit	T	3
Hoogte minimum	mm	670
Hoogte maximum	mm	1165
Koers	mm	495
Gewicht	kg	13,50
Prijs	€	53,50
		80,90



Afscherming - afbakening

METALWORKS



Kunststof afsluitbareel die uitschuifbaar is tot 2 meter en die gemakkelijk verplaatsbaar is. De brede voeten garanderen een prima stabiliteit.

Order nr.	758136714 €
Orig. nr.	FH200
Prijs	€ 119,00

METALWORKS



Uitbreiding voor FH200 die het makkelijk mogelijk maakt om grotere gebieden af te sluiten. Deze uitbreiding is eveneens uitschuifbaar tot 2 meter.

Order nr.	758136716 €
Orig. nr.	FHU200
Prijs	€ 94,00

METALWORKS



Vierkant scharrehcken in metaal, eveneens uitschuifbaar tot maximaal 1.3 meter. Ideaal geschikt om gevaarlijke zones af te schermen.

Order nr.	758136575 €
Orig. nr.	SI130
Prijs	€ 109,00

METALWORKS



Metalen afsluitbareel uitschuifbaar tot 2m (SI200) of tot 4m (SI400). Linker- en rechterkant van de bareel zijn voorzien van haak en ring voor het verbinden van meerdere barelen. Hoogte 1m. Er kunnen wielen met rem worden gemonteerd om het openen van en het verplaatsen van de bareel te vergemakkelijken. SI400 met extra voet in het midden voor een prima stabiliteit bij volledige benutting van de lengte.

Geleverd in 1 karton doos. Ongemonteerd.

Order nr.	745800450 €	745800460 €
Orig. nr.	SI200	SI400
Prijs	€ 79,00	159,00

METALWORKS



Afzetlint uit polypropyleen, leverbaar in rood-wit of zwart-geel.

Order nr.	758136873 €	758136874 €	758136878 €
Orig. nr.	PW100MZG	PW100MRW	PWT500MRW
Type	zwart/geel	rood/wit	
Breedte mm	50	50	80
Lengte m	100	100	500
Prijs	€ 5,20	5,20	23,00

METALWORKS



Kleefbare signalisatielinten uit plastic met een hoogte van 50 mm en op een rol van 33 m. Ideaal geschikt om gevaar te markeren. Recycleerbaar.

Order nr.	758136868 €	758136869 €
Orig. nr.	KS533ZG	KS533RW
Type	zwart/geel	rood/wit
Breedte mm	50	50
Lengte m	33	33
Prijs	€ 10,50	10,50

METALWORKS



Kleefbare signalisatielinten met antislip om uitglijden te vermijden. Gemaakt uit plastic met een hoogte van 50 mm en op een rol van 5 m. Recycleerbaar.

Order nr.	758136871 €	758136872 €
Orig. nr.	KS55Z	KS55ZG
Type	zwart	zwart/geel
Breedte mm	50	50
Lengte m	5	5
Prijs	€ 8,40	8,40

METALWORKS



Verkeerskegel in PE (hard) met licht reflecterende witte band. Rood-wit. Plaatsbesparend stapelbaar. Voor gebruik binnen het bedrijf.

Order nr.	745800550	745800560
Orig. nr.	SK30PE	SK54PE
Hoogte	mm 300	540
Omschrijving	1 witte band	2 witte banden
Materie	PE	PE
Prijs	€ 5,50	10,50

METALWORKS



Verkeerskegel in PVC met licht reflecterende witte band. Oranje-wit. Plaatsbesparend stapelbaar. Voor gebruik binnen het bedrijf. Samendrukbaar.

Order nr.	745800610
Orig. nr.	SK30PV
Hoogte	mm 300
Omschrijving	1 witte band
Materie	plooibaar PVC
Prijs	€ 7,60

METALWORKS



Verkeerskegel in PVC met reflecterende band klasse 1. Oranje-wit. Plaatsbesparend stapelbaar. Voor openbaar gebruik. Samendrukbaar.

Order nr.	745800630	745800640
Orig. nr.	SK30PV1	SK54PV1
Hoogte	mm 300	540
Omschrijving	2 witte banden, klasse 1	2 witte banden
Materie	plooibaar PVC	plooibaar PVC
Prijs	€ 9,20	15,40

METALWORKS



Afzetpaal met ronde voet en uittrekbare band van 2 meter. Band verkrijgbaar in geel/zwart uitvoering of uitvoering in gevaarsteken.

Order nr.	758136944	758136946
Orig. nr.	AU2GZ	AU2GE
Type	geel/zwart	gevaar
Lengte	m 2	2
Prijs	€ 174,00	174,00

METALWORKS



Afzetpaal met ronde voet en uittrekbare band van 2 meter. Band verkrijgbaar in rood/wit uitvoering of met verbodsteken.

Order nr.	758136950	758136952
Orig. nr.	AU2WR	AU2VE
Type	wit/rood	verbod
Lengte	mm 2000	2000
Omschrijving	afzetpaal met uittrekbare band	afzetpaal met uittrekbare band
Prijs	€ 174,00	174,00

METALWORKS



Afzetbanden met wandbevestiging, verkrijgbaar in verschillende uitvoeringen (rood/wit, zwart/geel, verboden doorgang, gevaar) met een lengte van ofwel 2 meter of een lengte van 4 meter.

Order nr.	Orig. nr.	Type	Lengte mm	Prijs €
758136958	AW2WR	wit/rood	2000	109,00
758136959	AW2GZ	zwart/geel	2000	109,00
758136961	AW2GE	gevaar	2000	109,00
758136962	AW2VE	verbod	2000	109,00
758136965	AW4WR	wit/rood	4000	189,00
758136966	AW4GZ	zwart/geel	4000	189,00
758136968	AW4GE	gevaar	4000	199,00
758136969	AW4VE	verbod	4000	199,00

METALWORKS



Afzetpaal in kunststof diam. 30mm in rood/wit uitvoering. Met achtkant basis. Hoogte 90cm. Totaal gewicht 675 gr. Afmeting basis 275x275mm x 85mm H. Verpakt in karton per 12 stuks.

Order nr.	754800102
Orig. nr.	SPP1RB
Prijs	€ 15,90

METALWORKS

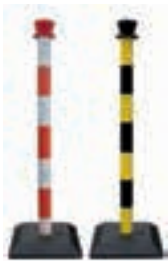

VERZWAARDE VOET

Afzetpaal in ABS, diameter 50mm, hoogte 950mm. Basis 0,35kg, kan gevuld worden met 2.5L water. Kettingen kunnen bevestigd worden aan de ring bovenaan. Verkrijgbaar in zwart/geel of wit/rood.

Order nr.	754800103	754800104
Orig. nr.	SPP2RB	SPP2NJ
Diameter	mm 5	5
Hoogte	mm 95	95
Prijs	€ 20,50	20,50

METALWORKS



Stalen afzetpaal met voet, diameter 50mm, hoogte 1000mm. Diameter basis: 360mm. Voorzien van gaten voor ketting KBR825 of latten SAP1BAR.

Order nr.	758136596	758136597
Orig. nr.	SPPS1ZG	SPPS1VWR
Diameter	mm 50	50
Hoogte	mm 1000	1000
Prijs	€ 56,50	56,50

METALWORKS



Plastiek ketting. Rood-wit. Wasbaar, niet geleidend, anti-magnetisch en licht. Temperatuur bestendig tussen -10°C en 75°C. Diameter schakel 8mm. Afmeting schakel 29x49mm. Lengte ketting: 25m. Individueel verpakt in een transparante lichtplastiek zak.

Order nr.	754800150
Orig. nr.	KBR825
Prijs	€ 43,90

METALWORKS

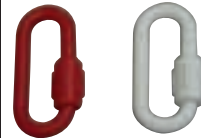

Set van 4 verbindingsringen voor ketting (2xR+2xW).

Order nr.	745800240
Orig. nr.	SR802
Dikte	mm 6
Prijs	€ 5,20

METALWORKS



Kunststof latten rood/wit voor metalen afzetpaal SPPS1WR. Lengte 1,2m.

Order nr.	758136598
Orig. nr.	SAP1BAR
Afmetingen (l x b x h)	mm 1200 x 100 x 20
Prijs	€ 40,90

METALWORKS



NEW

Presentatie-opzetstuk voor afzetpaal. Past op SPP1, SPP2, SPPS afzetpalen. Formaat A4.

Order nr.	745800662
Orig. nr.	SRP1
Prijs	€ 49,90

METALWORKS



NEW

Veiligheidsbeugels voor gebruik in gevarenszones in werkplaatsen als beveiliging of als afscheiding van verschillende zones. Ook buiten te gebruiken als afzetbeugel. Gele uitvoering met zwarte banden.. Voorzien van kniebuis ter versterking. Voet 150x150mm. BHK601500 in verzinkte uitvoering.

Order nr.	Orig. nr.	Diameter	Aantal	Afmetingen (l x b x h)	Prijs
		mm	banden	mm	€
745800701	BHK401000	40	6	1000 x 40 x 1000	85,00
745800702	BHK401500	40	6	1500 x 40 x 1000	93,00
745800703	BHK402000	40	6	2000 x 40 x 1000	112,00
745800704	BHK601000	60	6	1000 x 60 x 1000	102,00
745800705	BHK601500	60	0	1500 x 60 x 1000	125,00
745800706	BHK602000	60	6	2000 x 60 x 1000	144,00

METALWORKS



NEW
HEAVY DUTY

Extra zware veiligheidsbeugels voor gebruik in gevarenszones in werkplaatsen als beveiliging of als afscheiding van verschillende zones. Ook buiten te gebruiken als afzetbeugel. Gele uitvoering met zwarte banden (3M). Diameter 76mm, dikte 3mm. Voet 160x140x10mm.

BHK76: zonder plaat

BHK76P met versterkingsplaat 4mm dik

Order nr.	Orig. nr.	Diameter	Afmetingen (l x b x h)	Prijs
		mm	mm	€
745800707	BHK763835	76	375 x 76 x 350	124,00
745800708	BHK767535	76	750 x 76 x 350	138,00
745800709	BHK7610035	76	1000 x 76 x 350	152,00
745800710	BHK767560	76	750 x 76 x 600	166,00
745800711	BHK7610060	76	1000 x 76 x 600	175,00
745800712	BHK7675120	76	750 x 76 x 1200	207,00
745800713	BHK76100120	76	1000 x 76 x 1200	212,00
745800714	BHK76P7535	76	750 x 76 x 350	203,00
745800715	BHK76P10035	76	1000 x 76 x 350	221,00
745800716	BHK76P7560	76	750 x 76 x 600	288,00
745800717	BHK76P10060	76	1000 x 76 x 600	338,00

METALWORKS



NEW

Beschermhoek, beschermpeal en parkeerstop voor gebruik in gevarenszones in werkplaatsen als beveiliging of als afscheiding van verschillende zones. Extra zware uitvoering. Gele uitvoering met zwarte banden (3M).

Order nr.	Orig. nr.	Type	Dia- meter	Aantal banden	Afmetin- gen voet (b x d)	Afmetin- gen (l x b x h)	Prijs
			mm		mm	mm	€
745800718	BHKH35	hoek	76	5	160x140x10	600 x 600 x 350	265,00
745800719	BHKH60	hoek	76	5	160x140x10	600 x 600 x 600	319,00
745800720	BHKH120	hoek	76	5	160x140x10	600 x 600 x 1200	409,00
745800721	BHKP090	paal	90	2	200x200x10	200 x 200 x 1200	189,00
745800722	BHKP159	paal	159	2	250x250x15	250 x 250 x 1200	355,00
745800723	BHKP273	paal	273	2	400x400x20	400 x 400 x 1200	689,00
745800724	BHKS40	stop	76	1	130x70x10	400 x 130 x 86	74,00
745800725	BHKS80	stop	76	2	130x70x10	800 x 130 x 86	83,00
745800726	BHKS120	stop	76	2	130x70x10	1200 x 130 x 86	105,00

METALWORKS



NEW

Flexibele verkeerszuil diam 100mm, hoogte 800mm. PU. Wordt niet beschadigd en brengt geen schade aan voertuigen wanneer die erover rijden.

Order nr.	745800663	745800664
Orig. nr.	PPL80ZG	PPL80Z
Kleur	zwart-geel	zwart
Hardheid	A98	A98
Treksterkte	MPa 34	34
Rek tot breuk	% 350	350
Trekspanning bij 300% rek	MPa 23	23
Trekspanning bij 100% rek	MPa 17	17
Scheursterkte	KN/m 84	84
Gebruikstemperatuur	°C -20 - +70	-20 - +70
Prijs	€ 149,00	149,00

Veiligheidsmarkering

METALWORKS



Af scherming voor werkzaamheden of om te wijzen op gevaar en doorgang te verhinderen. Bestaat uit drie panelen die onderling verstelbaar zijn.

Order nr.	758136917 €
Orig. nr.	AFW1710
Afmetingen (l x b x h)	mm 1710 x 1000 x 0
Prijs	€ 125,00

METALWORKS



Uitbreiding voor AFWU570.

Order nr.	758136918 €
Orig. nr.	AFWU570
Afmetingen (l x b x h)	mm 570 x 1000 x 0
Prijs	€ 42,00

METALWORKS



Veiligheidsmarkering die voorbijgangers attent maakt op slipgevaar.

Order nr.	758136799 €
Orig. nr.	SL330
Afmetingen (l x b x h)	mm 330 x 680 x 0
Prijs	€ 16,90

Kabelbruggen

METALWORKS



Soepele kabelbrug in kunststof voor kabels met een maximale diameter van 12 mm. Verkrijgbaar per 3 meter (BKB300) of per 5 meter (BKB500). Ideaal geschikt om te gebruiken in uw kantoor.

Order nr.	758136973 €	758136974 €
Orig. nr.	BKB300	BKB500
Maximum diameter kabeldoorlaat	mm 12	12
Lengte	m 3	5
Prijs	€ 27,00	43,50

METALWORKS



Soepele kabelbrug in kunststof voor kabels met een maximale diameter van 15 mm. Verkrijgbaar per 3 meter (BKB300A) of per 5 meter (BKB500A). Ideaal geschikt om te gebruiken in uw kantoor.

Order nr.	758136975 €	758136976 €
Orig. nr.	BKB300A	BKB500A
Maximum diameter kabeldoorlaat	mm 15	15
Lengte	m 3	5
Prijs	€ 35,90	59,90

METALWORKS



Rigide kabelbrug in kunststof met twee doorgangen voor kabels met een maximale diameter van 10 mm. Enkel verkrijgbaar per 2 meter. Ideaal geschikt om te gebruiken in uw kantoor.

Order nr.	758136977 €
Orig. nr.	RKB200
Maximum diameter kabeldoorlaat	mm 10
Lengte	m 2
Prijs	€ 31,50

METALWORKS



Enkele hulpstukken bij de RKB200 om de kabels gemakkelijk doorgang te laten vinden in uw kantoor op een ordelijke manier.

Order nr.	758136978	758136979	758136980
Orig. nr.	RKB200H	RKB200T	RKB200C
Omschrijving	hoek	T-vorm	verbindingsstuk
Prijs	€ 5,20	€ 5,20	€ 5,20

METALWORKS



Ø 20mm Ø 40mm Ø 60mm



Slang- en kabelbrug voor 1 of meer kabels met max. diameter 20mm (SI1020), 40mm (SI0440) of 60mm (SI0260). Geschikt voor de bescherming van slangen en kabels bij wegovertgangen. Ook voor vrachtwagen- en kraanverkeer. Olie -en vetbestendig. Vervaardigd in rubber en zodoende elektrisch isolerend. De kabels of slangen worden van boven ingebracht. De brug kan gewoon op de grond worden gelegd of kan ook aan de grond gekleefd worden. Zeer flexibele rubber. Kan zeer compact worden opgeborgen. Geleverd in rol. SI0260 is voorzien van gele reflecterende strips om de zichtbaarheid te verhogen.

Order nr.	745800010	745800020	745800025
Orig. nr.	SI1020	SI0440	SI0260
Maximum diameter kabeldoorlaat	mm 20	40	60
Lengte	m 10	4	2
Afmetingen (l x b x h)	mm 10000 x 100 x 30	4000 x 170 x 50	2000 x 240 x 72
Prijs	€ 209,00	€ 209,00	€ 219,00

METALWORKS



Stevige kabelbrug in rubber. Lengte per module 50cm.

Order nr.	758136970	758136971	758136972
Orig. nr.	KB500	KB800	KB1200
Maximum diameter kabeldoorlaat	mm 2 x 50	2 x 80	120
Lengte	m 0,5	0,6	0,8
Capaciteit	T 40	40	40
Prijs	€ 95,00	€ 138,00	€ 269,00

METALWORKS



Kabelbrug in kunststof, geschikt voor twee kabels met telkens een diameter van maximaal 35 mm. De kabels worden langs boven ingebracht. De TKB240 is ideaal geschikt voor duurzaam gebruik, laat de doorgang van auto's gemakkelijk toe en heeft een licht remmend effect. Bevestigbaar op zowel beton als op asfalt.

Order nr.	758136639
Orig. nr.	TKB240
Type	zwart/geel
Maximum diameter kabeldoorlaat	mm 35
Afmetingen (l x b x h)	mm 500 x 500 x 60
Prijs	€ 92,50

METALWORKS



Accessoires. De TKB240H sluit perfect aan op de TKB240 en is ideaal geschikt om een hoek van 45° te vormen. De kabelbrug kan langs beide uiteinden afgesloten worden met de TKB240S.

Order nr.	758136651	758136657
Orig. nr.	TKB240S	TKB240H
Afmetingen (l x b x h)	mm 200 x 500 x 60	250 x 50 x 60
Prijs	€ 45,90	€ 66,90

METALWORKS



Kabelbrug in kunststof, geschikt voor vier kabels met telkens een diameter van ongeveer 40 mm. De kabels worden langs boven ingebracht. De RKB440 is ideaal geschikt voor duurzaam gebruik, laat de doorgang van auto's gemakkelijk toe en heeft een licht remmend effect. Bevestigbaar op zowel beton als op asfalt.

Order nr.	758136640
Orig. nr.	RKB440
Maximum diameter kabeldoorlaat	mm 40
Afmetingen (l x b x h)	mm 500 x 400 x 70
Prijs	€ 117,00

EQUIPMENT

METALWORKS



Accessoires. De RKB440H sluit perfect aan op de RKB440 en is ideaal geschikt om een hoek van 90° te vormen. De kabelbrug kan langs beide uiteinden afgesloten worden met de RKB440S.

Order nr.	758136652	758136658
Orig. nr.	RKB440S	RKB440H
Omschrijving	eindstuk	hoek 90°
Afmetingen (l x b x h) mm	200 x 500 x 70	250 x 50 x 70
Prijs	€ 40,90	103,00

METALWORKS



Kabelbrug in kunststof, geschikt voor vijf kabels met telkens een diameter van maximaal 35 mm. De kabels worden ook hier langs boven ingebracht. Doordat de RKB535 gemakkelijk te installeren valt, is deze ideaal geschikt voor tijdelijk gebruik zoals bijvoorbeeld op beurzen. Wegens het tijdelijke karakter van deze kabelbrug is deze enkel bevestigbaar met lijm. Belasting tot 40 ton mogelijk.

Order nr.	758136637
Orig. nr.	RKB535
Maximum diameter kabeldoorlaat mm	35
Afmetingen (l x b x h) mm	790 x 440 x 50
Prijs	€ 127,00

METALWORKS



De RKB535H sluit perfect aan op de RKB535 en is ideaal geschikt om een hoek van 30° te vormen.

Order nr.	758136656
Orig. nr.	RKB535S
Omschrijving	hoek 30°
Afmetingen (l x b x h) mm	380 x 440 x 50
Prijs	€ 45,90

Verkeersdrempels

METALWORKS



Toegangsdrempel in puur rubber, klein hoogteverschil van 6 mm tot 15 mm. Ideaal geschikt om poortdoorgangen te accentueren (geel-zwarte uitvoering).

Order nr.	758136926
Orig. nr.	TD1200
Afmetingen (l x b x h) mm	1200 x 300 x 42156
Prijs	€ 59,00

METALWORKS



Oprijdrempel in puur rubber. Ideaal geschikt om een hoogteverschil te overwinnen. Geel-zwarte uitvoering met dubbele kabeldoorvoer. Kan worden afgeboord aan de beide uiteinden met rond eindstuk. Aan de grond bevestigbaar met ofwel spijkers, pluggen of polyurethane lijm (zie accessoires).

Order nr.	758136856	758136859	758136861
Orig. nr.	OD100	OD150	OD200
Maximum diameter kabeldoorlaat mm	25-30	30-35	35-40
Afmetingen (l x b x h) mm	600 x 300 x 100	600 x 360 x 150	600 x 450 x 200
Prijs	€ 79,50	114,00	171,00

METALWORKS



Eindstuk voor OD100-OD150-OD200.

Order nr.	758136863	758136864	758136865
Orig. nr.	HOD100	HOD150	HOD200
Voor type	OD100	OD150	OD200
Afmetingen (l x b x h) mm	300 x 300 x 100	360 x 360 x 150	450 x 450 x 200
Prijs	€ 37,00	58,00	90,00



METALWORKS



Accessoires voor OD.

Order nr.	758136867	758136866	758136855
Orig. nr.	ODFIXA	ODFIXB	VKCOLPU
Omschrijving	set met spijkers geschikt voor bevestiging in asfalt	set met pluggen geschikt voor bevestiging in beton	lijm geschikt voor bevestiging op alle ondergronden
Capaciteit			290ml
Prijs	€ 7,00	11,00	31,90

METALWORKS



Verkeersdrempel in gerecycleerd rubber. Maximale belasting 20T met snelheidsremmend effect van maximaal 30 km/h. 1 kabeldoorvoer met een diameter van 27 mm. Verkrijgbaar in geel-zwarte uitvoering. Kan worden afgeboord aan de beide uiteinden met rond eindstuk. Aan de grond bevestigbaar met ofwel spijkers, pluggen of polyurethane lijm (zie accessoires). Drempel heeft een lengte van 250 mm, uitbreiding tot gewenste lengte mogelijk. Dit artikel bestaat uit een geel stuk en een zwart stuk van telkens 250mm, en is in totaal 500mm lang.

Order nr.	758136895
Orig. nr.	VK50250ZG
Afmetingen (l x b x h)	mm 350 x 250 x 50
Prijs	€ 59,00

METALWORKS



Eindstuk voor verkeersdrempel.

Order nr.	758136898
Orig. nr.	VK50250ZG
Voor type	VK50250ZG
Afmetingen (l x b x h)	mm 350 x 200 x 50
Prijs	€ 38,00

METALWORKS



Verkeersdrempel in gerecycleerd rubber. Maximale belasting 20T met snelheidsremmend effect van maximaal 15 km/h. 1 kabeldoorvoer met een diameter van 27 mm. Verkrijgbaar in geel-zwarte uitvoering. Kan worden afgeboord aan de beide uiteinden met rond eindstuk. Aan de grond bevestigbaar met ofwel spijkers, pluggen of polyurethane lijm (zie accessoires). Elk stuk heeft een lengte van 250 mm, uitbreiding tot gewenste lengte mogelijk. Dit artikel bestaat uit een geel stuk en een zwart stuk van telkens 250mm, en is in totaal 500mm lang.

Order nr.	758136896
Orig. nr.	VK70250ZG
Afmetingen (l x b x h)	mm 500 x 220 x 70
Prijs	€ 69,00

METALWORKS



Eindstuk voor verkeersdrempel.

Order nr.	758136899
Orig. nr.	VK570250ZG
Voor type	VK70250ZG
Prijs	€ 50,50

METALWORKS



Verkeersdrempel in gerecycleerd rubber. Maximale belasting 20T met snelheidsremmend effect van maximaal 30 km/h. Dubbele kabeldoorvoer met telkens een diameter van 30 mm. Kan worden afgeboord aan de beide uiteinden met rond eindstuk. Aan de grond bevestigbaar met ofwel spijkers, pluggen of polyurethane lijm (zie accessoires). Drempel heeft een lengte van 1830 mm. Spijkers bijgeleverd.

Order nr.	758136891
Orig. nr.	VK55183ZG
Afmetingen (l x b x h)	mm 1830 x 300 x 55
Prijs	€ 147,00

METALWORKS



Eindstuk voor verkeersdrempel.

Order nr.	758136893
Orig. nr.	VK55183ZG
Voor type	VK55183ZG
Afmetingen (l x b x h)	mm 180 x 300 x 55
Prijs	€ 24,50

METALWORKS



Verkeersdrempel in puur rubber. Maximale belasting 40T met snelheidsremmend effect van maximaal 15 km/h. Dubbele kabeldoorvoer met telkens een diameter van 30 mm. Kan worden afgeboord aan de beide uiteinden met rond eindstuk. Aan de grond bevestigbaar met ofwel spijkers, pluggen of polyerethane lijm (zie accessoires). Drempel heeft een lengte van 1830 mm. Spijkers bijgeleverd.

Order nr.	758136692 €
Orig. nr.	VK751830RW
Afmetingen (l x b x h)	mm 1830 x 300 x 75
Prijs	€ 304,00

METALWORKS



Eindstuk voor verkeersdrempel.

Order nr.	758136696 €
Orig. nr.	VKS75183R
Voor type	VK751830RW
Afmetingen (l x b x h)	mm 250 x 300 x 75
Prijs	€ 38,90

METALWORKS

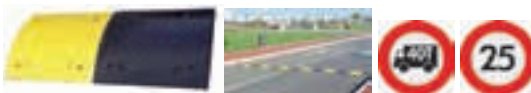

Verkeersdrempel in puur rubber. Maximale belasting 40T met snelheidsremmend effect van maximaal 15 tot 30 km/h. 1 kabeldoorvoer met een diameter van 27 mm. Kan worden afgeboord aan de beide uiteinden met rond eindstuk. Aan de grond bevestigbaar met ofwel spijkers, pluggen of polyerethane lijm (zie accessoires). Drempel heeft een lengte van 500mm., uitbreiding tot gewenste lengte mogelijk.

Order nr.	758136709 €
Orig. nr.	VK60100ZG
Afmetingen (l x b x h)	mm 500 x 430 x 60
Prijs	€ 144,00

METALWORKS



Eindstuk voor verkeersdrempel.

Order nr.	758136710 €
Orig. nr.	VKS60100ZG
Voor type	VK60100ZG
Afmetingen (l x b x h)	mm 250 x 430 x 60
Prijs	€ 47,00

METALWORKS



Verkeersdrempel in puur rubber. Maximale belasting 10T met snelheidsremmend effect van maximaal 5 tot 10 km/h. Geen kabeldoorvoer mogelijk. Kan worden afgeboord aan de beide uiteinden met rond eindstuk. Aan de grond bevestigbaar met ofwel spijkers, pluggen of polyerethane lijm (zie accessoires). Drempel heeft een lengte van 500 mm, uitbreiding tot gewenste lengte mogelijk. Ideaal geschikt om de snelheid in de werkplaats te beperken.

Order nr.	758136880 €
Orig. nr.	VK2025ZG
Afmetingen (l x b x h)	mm 600 x 500 x 20
Prijs	€ 63,00

METALWORKS



Eindstuk voor verkeersdrempel.

Order nr.	758136883 €
Orig. nr.	VKS2025GR
Voor type	VK2025ZG
Afmetingen (l x b x h)	mm 600 x 300 x 20
Prijs	€ 31,00

METALWORKS



Accessoires bij verkeersdrempels en kabelbruggen.

Order nr.	758136901	758136718	758136855	758136897
Orig. nr.	VKFIX300	VKFIX120	VKCOLPU	VKFIX4H
Omschrijving	spijkers geschikt voor bevestiging in asfalt	pluggen geschikt voor bevestiging in beton	lijm geschikt voor bevestiging op alle ondergronden	H-vormige verbindingsonderdelen ter bevordering van onderlinge stevigheid
Aantal stuks	4	4	1	4
Capaciteit	300mm	120mm	290ml	-
Prijs	€ 4,00	10,50	31,90	8,10

Omgevingspiegels

METALWORKS

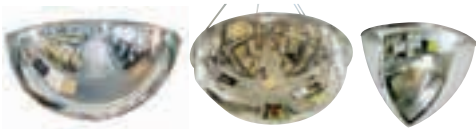

Veiligheidsspiegel met een diameter van 65 mm. Ter beveiliging van uw burelen of winkelruimten. Onbreekbaar. Inclusief bevestiging. De SPS90 bedekt een hoek van 90°, de SPS180 een hoek van 180° en de SPS360 een hoek van 360°.

Order nr.	758136756	758136754	758136755
Orig. nr.	SPS90	SPS180	SPS360
Diameter	mm 650	650	650
Hoek	° 90	180	360
Prijs	€ 63,00	115,00	159,00

METALWORKS



Veiligheidsspiegel. Ter beveiliging van uw burelen en winkel. Voor binnengebruik met glazen spiegel van 33mm. Niet verstelbaar onder hoek.

Order nr.	745800540
Orig. nr.	SSP330
Diameter	mm 330
Prijs	€ 46,90

METALWORKS



Veiligheidsspiegel. Ter beveiliging van uw parking en winkel. Voor buitengebruik met spiegel van 600mm in polycarbonaat. Onder hoek verstelbaar.

Order nr.	745800520
Orig. nr.	SSP600
Diameter	mm 600
Prijs	€ 146,00

METALWORKS



Veiligheidsspiegel. Ter beveiliging van uw winkel en parking. Voor buitengebruik met glazen spiegel en afmetingen 490x790mm. Onder hoek verstelbaar.

Order nr.	758136729
Orig. nr.	SSP177RW
Afmetingen (l x b x h)	mm 490 x 790 x 0
Prijs	€ 264,00

METALWORKS



Parkeerbeugel in metalen uitvoering met hangslot. Ideaal geschikt voor het vrijhouden van parkeerplaatsen.

Order nr.	758136909
Orig. nr.	PBC38
Omschrijving	met hangslot
Diameter	mm 38
Afmetingen (l x b x h)	mm 735 x 375 x 0
Prijs	€ 59,90

METALWORKS



Parkeerbeugel in metalen uitvoering met cylinderslot. Geleverd met 1 sleutel. Ideaal geschikt voor het vrijhouden van parkeerplaatsen. Verschillende sleutel/slot voor elke parkeerbeugel. Parkeerbeugel met identieke sloten mogelijk op aanvraag.

Order nr.	758136906
Orig. nr.	PBB54
Omschrijving	met cylinderslot
Diameter	mm 54
Afmetingen (l x b x h)	mm 860 x 465 x 0
Prijs	€ 119,00

Brandbescherming

METALWORKS



Blusdeken in een opbergzak. Conform CE EN 1869

Het glasvezel deken heeft alle eigenschappen van de asbestdekens, maar dan zonder de nadelen.

Twee treklijnen laten toe het deken snel uit de verpakking te halen en de vuurhaard in alle veiligheid te benaderen en te doven.

Het blijft hangen aan ruwe oppervlaktes. De grote formaten zijn bijzonder geschikt om iemand, wiens kledij vuur heeft gevat, in te wikkelen.

Op de verpakking is een duidelijk leesbaar etiket met gebruiksinstructies en wasvoorschriften aangebracht. Het gewichtsverlies door thermische afbraak na 1 uur blootstelling aan een temperatuur van 800° bedraagt minder dan 2%.

Order nr.	850003011
Orig. nr.	JOB120
Prijs	€ 48,50



Absorptiematerialen

METALWORKS

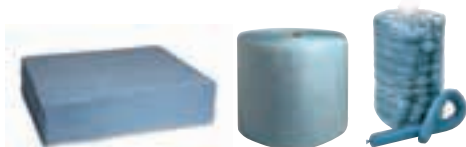

Absorptiematerialen voor olielekken, ontworpen voor dagelijks gebruik op de werkvloer. Absorbeert alle oliën en koolwaterstoffen, ideaal geschikt voor het 'snel opruimen' van een lek, vooral bij machines of wagenparken. Stoot eveneens water af.

Order nr.	Orig. nr.	Samenstelling	Gewicht	Afmetingen (l x b x h)	Prijs
			kg	mm	€
724576491	D100	100 doeken	6,00	400 x 500 x 0	158,00
724576492	D200	200 doeken	7,20	400 x 500 x 0	158,00
724576493	R1	1 rol	10,00	400 x 800 x 0	285,00
724576494	R2	2 rollen	10,00	400 x 400 x 0	285,00
724576495	SLO12	12 slangen	8,00	1200 x 75 x 0	153,00
724576496	SLO4	4 slangen	4,00	3000 x 130 x 0	189,00
724576497	KG16	16 kussens groot	8,00	420 x 420 x 40	175,00

METALWORKS



Interventiekits met absorptiemiddelen en persoonlijke beschermmiddelen, stellen u in staat om snel te reageren op elk incident.

Transparante tas met 20 doeken en twee slangen van 1.2 meter. 1 paar handschoenen en 1 afvalzak met dichtingstrip.

Order nr.	724576500			
Orig. nr.				IKO
Gewicht	kg			15,00
Prijs	€			85,00

Opvangbakken

METALWORKS



Opvang voor bidons van 25 liter. Uit rotatiegegoten geel PE. Uiterst corrosieresistent. Geschikt voor olieën, chemicaliën en zuren. Plastic bovenplaat zodat de bidon niet in de vloeistof komt te staan. Capaciteit conform de Vlaamse (Vlarem), Waalse en Nederlandse (CPR) milieuriichtlijnen.

Order nr.	724576519		
Orig. nr.			OVB25
Capaciteit	l		1x25
Gewicht	kg		5,00
Afmetingen (l x b x h)	mm		550 x 550 x 110
Prijs	€		158,00

METALWORKS



Opvang voor bidons van 25 liter. Uit rotatiegegoten geel PE. Uiterst corrosieresistent. Geschikt voor olieën, chemicaliën en zuren. Plastic bovenplaat zodat de bidon niet in de vloeistof komt te staan. Capaciteit conform de Vlaamse (Vlarem), Waalse en Nederlandse (CPR) milieuriichtlijnen.

Order nr.	724576050		
Orig. nr.			OVB50
Capaciteit	l		2x25
Gewicht	kg		5,50
Afmetingen (l x b x h)	mm		715 x 460 x 110
Prijs	€		189,00

METALWORKS



Opvangwerkvloer voor bidons van 25 liter. Uit rotatiegegoten geel PE. Uiterst corrosieresistent. Plastic bovenplaat zodat de bidon niet in de vloeistof komt te staan. Capaciteit conform de Vlaamse (Vlarem), Waalse en Nederlandse (CPR) milieuriichtlijnen.

Order nr.	724576050	724576521	€
Orig. nr.	OV850	OV8100	
Capaciteit	l	2x25	4x25
Gewicht	kg	5,50	15,00
Afmetingen (l x b x h)	mm	715 x 460 x 110	920 x 720 x 175
Prijs	€	189,00	264,00

METALWORKS



Opvangwerkvloer voor 2 vaten van 60 l of 1 vat van 200l. Uit rotatiegegoten blauw PE. Lage hoogte (150mm) maakt het eenvoudig om te laden en te lossen. Kan worden gebruikt met de oprijplaat OPR. Alle OPW-modellen kunnen samen worden gecombineerd tot een groot platform. Uiterst corrosieresistent. Met uitneembaar zwart PE rooster voor een eenvoudige reiniging van de opvangbak. Capaciteit conform de Vlaamse (Vlarem), Waalse en Nederlandse (CPR) milieuriichtlijnen.

Order nr.	724576200	€
Orig. nr.	OPW2	
Capaciteit	l	2x60
Gewicht	kg	20,00
Afmetingen (l x b x h)	mm	1260 x 860 x 150
Prijs	€	339,00

METALWORKS



Opvangwerkvloer voor 4 vaten van 200 l. Uit rotatiegegoten blauw PE. Lage hoogte (150mm) maakt het eenvoudig om te laden en te lossen. Kan worden gebruikt met de oprijplaat OPR. Alle OPW-modellen kunnen samen worden gecombineerd tot een groot platform. Uiterst corrosieresistent. Met 2 uitneembare zwarte PE roosters voor een eenvoudige reiniging van de opvangbak. Capaciteit conform de Vlaamse (Vlarem), Waalse en Nederlandse (CPR) milieuriichtlijnen.

Order nr.	724576400	€
Orig. nr.	OPW4	
Capaciteit	l	4x200
Gewicht	kg	40,00
Afmetingen (l x b x h)	mm	1660 x 1260 x 150
Prijs	€	545,00

METALWORKS



Opvangwerkvloer voor 4 vaten van 200 l. op 1 rij. Uit rotatiegegoten blauw PE. Lage hoogte (150mm) maakt het eenvoudig om te laden en te lossen. Kan worden gebruikt met de oprijplaat OPR. Alle OPW-modellen kunnen samen worden gecombineerd tot een groot platform. Uiterst corrosieresistent. Met 2 uitneembare zwarte PE roosters voor een eenvoudige reiniging van de opvangbak. Capaciteit conform de Vlaamse (Vlarem), Waalse en Nederlandse (CPR) milieuriichtlijnen.

Order nr.	724576405	€
Orig. nr.	OPW4L	
Capaciteit	l	4x200
Gewicht	kg	48,00
Afmetingen (l x b x h)	mm	2610 x 895 x 150
Prijs	€	569,00

METALWORKS

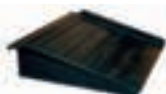

PE oprijplaat die in combinatie met de OPW-opvangbakken wordt gebruikt. Met deze oprijplaat kunnen pallets of vaten met een transportwagen of transpallet op de opvangwerkvloer worden geplaatst. Capaciteit conform de Vlaamse (Vlarem), Waalse en Nederlandse (CPR) milieuriichtlijnen.

Order nr.	724576490	€
Orig. nr.	OPR	
Gewicht	kg	9,00
Afmetingen (l x b x h)	mm	2610 x 895 x 150
Prijs	€	189,00

METALWORKS



Flexibele opvangbak voor 2 vaten van 200 liter. Maakt het mogelijk om een standaard houten vatenpallet om te bouwen tot lekbak. Vervaardigd uit kunststof waardoor deze gebruikt kan worden bij chemicaliën en zuren. De voorkant kan gemakkelijk omhoog en naar beneden worden gedaan zodat er een pallet in geplaatst kan worden. Geschikt voor pallets van 1200x800 mm. Capaciteit conform de Vlaamse (Vlarem), Waalse en Nederlandse (CPR) milieurechtlijnen.

Order nr.	724576508 €		
Orig. nr.	FOP2		
Capaciteit	l	2x200	
Gewicht	kg	18,00	
Afmetingen (l x b x h)	mm	14500 x 1100 x 440	
Prijs	€	423,00	

METALWORKS



Opvangbak voor 1 vat van 200 liter. Uit rotatiegegoten geel PE. Uiterst corrosieresistent. Met uitneembaar zwart PE rooster voor een eenvoudige reiniging van de opvangbak. Capaciteit conform de Vlaamse (Vlarem), Waalse en Nederlandse (CPR) milieurechtlijnen.

Order nr.	724576502 €		
Orig. nr.	OPB12		
Capaciteit	l	1x200	
Gewicht	kg	22,00	
Afmetingen (l x b x h)	mm	900 x 700 x 525	
Prijs	€	327,00	

METALWORKS



Flexibele opvangbak voor 4 vaten van 200 liter. Maakt het mogelijk om een standaard houten vatenpallet om te bouwen tot lekbak. Vervaardigd uit kunststof waardoor deze gebruikt kan worden bij chemicaliën en zuren. De voorkant kan gemakkelijk omhoog en naar beneden worden gedaan zodat er een pallet in geplaatst kan worden. Geschikt voor pallets van 1000x1200mm. Capaciteit conform de Vlaamse (Vlarem), Waalse en Nederlandse (CPR) milieurechtlijnen.

Order nr.	724576509 €		
Orig. nr.	FOP4		
Capaciteit	l	4x200	
Gewicht	kg	20,00	
Afmetingen (l x b x h)	mm	14500 x 1300 x 440	
Prijs	€	497,00	

METALWORKS



Opvangbak voor 4 vaten van 200 liter met laag profiel. Uit rotatiegegoten geel PE. Uiterst corrosieresistent. Met uitneembaar zwart PE rooster voor een eenvoudige reiniging van de opvangbak. De opvangbak heeft 2 inkepingen onderaan voor verplaatsing met transpallet. Capaciteit conform de Vlaamse (Vlarem), Waalse en Nederlandse (CPR) milieurechtlijnen.

Order nr.	724576505 €		
Orig. nr.	OPB42		
Capaciteit	l	4x200	
Gewicht	kg	25,00	
Afmetingen (l x b x h)	mm	1280 x 1280 x 275	
Prijs	€	455,00	

METALWORKS



Opvangbak voor 2 vaten van 200 l. Uit rotatiegegoten blauw PE. Uiterst corrosieresistent. Met uitneembaar zwart PE rooster voor een eenvoudige reiniging van de opvangbak. Voorzien van 2 inkepingen onderaan voor verplaatsing met transpallet. Capaciteit conform de Vlaamse (Vlarem), Waalse en Nederlandse (CPR) milieuriichtlijnen.

Order nr.	724576020	
Orig. nr.	OPB2	
Capaciteit	l	2x200
Gewicht	kg	26,00
Afmetingen (l x b x h)	mm	1220 x 820 x 330
Prijs	€	327,00

METALWORKS



Opvangbak voor 4 vaten van 200 l. Uit rotatiegegoten blauw PE. Uiterst corrosieresistent. Met uitneembaar zwart PE rooster voor een eenvoudige reiniging van de opvangbak. De opvangbak heeft 2 inkepingen onderaan voor verplaatsing met transpallet. Capaciteit conform de Vlaamse (Vlarem), Waalse en Nederlandse (CPR) milieuriichtlijnen.

Order nr.	724576040	
Orig. nr.	OPB4	
Capaciteit	l	4x200
Gewicht	kg	44,00
Afmetingen (l x b x h)	mm	1310 x 1310 x 370
Prijs	€	545,00

METALWORKS



Opvangbak voor 2 IBC'S van 1000 l of 8 vaten van 200 l. Uit rotatiegegoten blauw PE. Uiterst corrosieresistent. Met 3 uitneembare zwarte PE roosters voor een eenvoudige reiniging van de opvangbak. De opvangbak heeft 2 inkepingen onderaan voor verplaatsing met transpallet. Optioneel : voorzetray. Capaciteit conform de Vlaamse (Vlarem), Waalse en Nederlandse (CPR) milieuriichtlijnen.

Order nr.	724576080	
Orig. nr.	OPB8	
Capaciteit	l	2 IBC's 1000 of 8 vaten van 200
Gewicht	kg	136,00
Afmetingen (l x b x h)	mm	2560 x 1350 x 510
Prijs	€	1.475,00

METALWORKS



Opvangbak voor 4 vaten van 200 liter met afschermrolluik. Uit rotatiegegoten geel PE. Uiterst corrosieresistent. Met uitneembaar zwart PE rooster voor een eenvoudige reiniging van de opvangbak. De opvangbak heeft 2 inkepingen onderaan voor verplaatsing met transpallet. Capaciteit conform de Vlaamse (Vlarem), Waalse en Nederlandse (CPR) milieuriichtlijnen.

Order nr.	724576506	
Orig. nr.	OPBH42	
Capaciteit	l	4x200
Gewicht	kg	115,00
Afmetingen (l x b x h)	mm	1470 x 1420 x 2070
Prijs	€	1.259,00

METALWORKS



Opvangbak voor 1 IBC van 1000 liter. Uit rotatiegegoten geel PE. Uiterst corrosieresistent. Deze opvangbak heeft geen rooster. De IBC steunt op 4 ingebouwde steunvoeten. De opvangbak heeft 2 inkepingen onderaan voor verplaatsing met transpallet of vorkheftruck. Capaciteit conform de Vlaamse (Vlarem), Waalse en Nederlandse (CPR) milieurechtlijnen.

Order nr.	724576512 €	
Orig. nr.	OV/BIBC1	
Capaciteit	l	1 IBC 1000
Gewicht	kg	80,00
Afmetingen (l x b x h)	mm	1590 x 1455 x 715
Prijs	€	1.105,00

METALWORKS



Voorzettray voor OPB8. Capaciteit conform de Vlaamse (Vlarem), Waalse en Nederlandse (CPR) milieurechtlijnen.

Order nr.	724576090 €	
Orig. nr.	TRIBC	
Gewicht	kg	20,00
Afmetingen (l x b x h)	mm	2560 x 1350 x 510
Prijs	€	175,00

METALWORKS



Opvangbak voor 1 IBC van 1000 l met ingebouwde aftaptray. Uit rotatiegegoten blauw PE. Uiterst corrosieresistent. Deze opvangbak heeft geen rooster. De IBC steunt op 4 ingebouwde steunvoeten. De opvangbak heeft 2 inkepingen onderaan voor verplaatsing met transpallet. Capaciteit conform de Vlaamse (Vlarem), Waalse en Nederlandse (CPR) milieurechtlijnen.

Order nr.	724576085 €	
Orig. nr.	OPBIBC	
Capaciteit	l	1 IBC 1100
Gewicht	kg	86,00
Afmetingen (l x b x h)	mm	1950 x 1400 x 725
Prijs	€	1.245,00

METALWORKS



Opvangbak voor 1 IBC van 1000 liter met rooster. Uit rotatiegegoten geel PE. Uiterst corrosieresistent. Geschikt voor oliën, chemicaliën en zuren. Kan worden verplaatst door een transpallet of vorkheftruck dankzij 2 inkepingen onderaan. Capaciteit conform de Vlaamse (Vlarem), Waalse en Nederlandse (CPR) milieurechtlijnen.

Order nr.	724576510 €	
Orig. nr.	OV/BIBC1R	
Capaciteit	l	1 IBC 1000
Gewicht	kg	107,00
Afmetingen (l x b x h)	mm	1760 x 1350 x 710
Prijs	€	1.295,00

METALWORKS



Opvangbak voor 2 IBC's van 1000 liter. Uit rotatiegegoten geel PE. Uiterst corrosieresistent. Deze opvangbak heeft geen rooster. De opvangbak heeft 2 inkepingen onderaan voor verplaatsing met transpallet of vorkheftruck. Capaciteit conform de Vlaamse (Vlarem), Waalse en Nederlandse (CPR) milieुरichtlijnen.

Order nr.	724576514 €	
Orig. nr.	OV/BIBC2	
Capaciteit	l	2 IBC 1000
Gewicht	kg	85,00
Afmetingen (l x b x h)	mm	2340 x 1360 x 510
Prijs	€	1.175,00

METALWORKS



Trechter voor opvangbakken. Kostenbesparende en praktische manier om uw vaten of ibc's te vullen.

Order nr.	724576522 €	724576523 €
Orig. nr.	VT2	VT10
Capaciteit	vat van 200	IBC van 1000
Diameter	610x230	640x150
Gewicht	kg	4,00
Prijs	€	154,00
		179,00

Veilig transport

METALWORKS



Vatenkarretje uit 100 procent rotatiegegoten polyethyleen, voor 1 vat van 200 liter of voor kleinere bidons. Vier zwenkwielen waarvan er twee kunnen worden vastgezet. Ook geschikt voor het vervoeren van batterijen.

Order nr.	724576524 €	
Orig. nr.	VK2	
Gewicht	kg	15,50
Prijs	€	349,00

METALWORKS



Vatenkar voor het vervoeren van kleinere bidons, batterijen en andere kleine ladingen.

Order nr.	724576525 €	
Orig. nr.	VKBB	
Gewicht	kg	18,00
Prijs	€	379,00

METALWORKS



Combinatie van een vatenlift, vatenkar, opvangpallet en verdeleenheid die het mogelijk maakt dat slechts één persoon gemakkelijk alle hef- en kantelbewegingen kan uitvoeren met een vol 200 liter - vat. Onderaan twee vaste wielen en 1 zwenkwiel met rem. Twee bevestigingsriemen om vat stevig vast te zetten.

Order nr.	724576526 €	
Orig. nr.	VK1	
Gewicht	kg	44,00
Prijs	€	699,00



STEL UW EIGEN WERKPLAATS SAMEN



Ladenkasten



Opbergkasten



Werkbanken

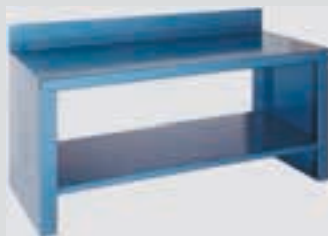

Wandpanelen



OOK IN ANDERE
KLEUREN BESCHIKBAAR

■ ORIG NR MET EXTENSIE OE
■ ORIG NR MET EXTENSIE RE



Heco opbergkasten



HE1301



OOK IN ANDERE
KLEUREN BESCHIKBAAR

■ ORIG NR MET EXTENSIE GE
■ ORIG NR MET EXTENSIE RE

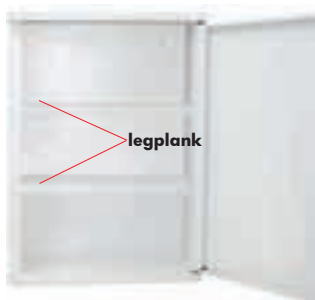

HE1302

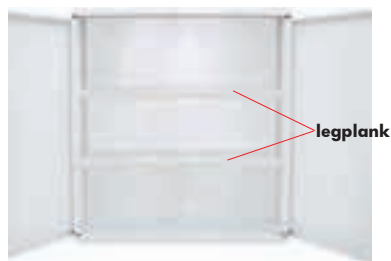

HE1303



EQUIPMENT

EHBO-kasten.

Order nr.	761000915 €	761000916 €	761000917 €
Orig. nr.	HE1301	HE1302	HE1303
Aantal inlegborden	1	2	2
Aantal deuren	1	1	2
Gewicht	kg 5,50	8,00	22,00
Afmetingen (l x b x h)	mm 400 x 150 x 450	400 x 150 x 600	800 x 150 x 880
Prijs	€ 198,00	259,00	374,00



- gelaste gereedschapshouders
- slot met sleutel
- vaste legplank



geleverd zonder gereedschappen

HE1141BL



- 2 legplanken, verstelbaar om de 25mm
- slot met sleutel
- vaste legplank



HE1142BL



- 10 V-BULL 1
- gelaste gereedschapshouders
- 15 V-BULL 2
- slot met sleutel
- vaste legplank



HE114CBL



geleverd zonder gereedschappen



- geperforeerd paneel tegen de wand en zijkant
- gelaste gereedschapshouders
- slot met sleutel
- vaste legplank

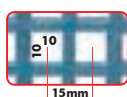

geleverd zonder gereedschappen

HE114PBL

Gereedschapskast in zeer stabiele en zware uitvoering geschikt voor intensief en industrieel gebruik. Constructie in plaatstaal 10/10mm met een poederlak coating in lichte hamerslag uitvoering.

- breedte 605mm, hoogte 900mm en diepte 230mm
- verschillende indelingen mogelijk
- capaciteit : tot 118 gereedschappen

Order nr.	Orig. nr.	Gewicht kg	Afmetingen (l x b x h) mm	Prijs €
761000293	HE1141BL	21,00	605 x 230 x 900	287,00
761000294	HE1142BL	25,42	605 x 230 x 900	291,00
761000295	HE114CBL	21,00	605 x 230 x 900	321,00
761000297	HE114PBL	19,00	605 x 230 x 900	280,00



HE1251BL



HE1252BL



EQUIPMENT

**OOK IN ANDERE
KLEUREN BESCHIKBAAR**

ORIG NR MET EXTENSIE GR

ORIG NR MET EXTENSIE RE

Gereedschapskasten in zeer stabiele en zware uitvoering, geschikt voor intensief en industrieel gebruik. Constructie in plaatstaal 10/10mm met een poederlak coating in lichte hamerslag uitvoering.

Order nr.		761000817 €	761000828 €
Orig. nr.		HE1251BL	HE1252BL
Gewicht	kg	38,00	47,00
Afmetingen (l x b x h)	mm	513 x 623 x 700	513 x 623 x 1000
Prijs	€	345,00	417,00

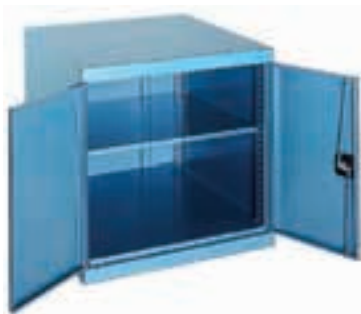
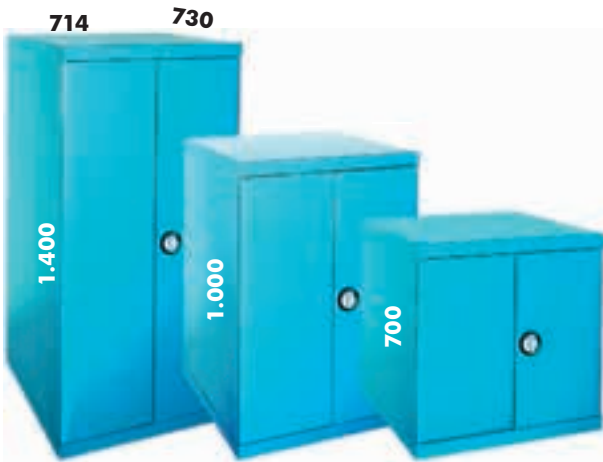

HE1261BL



HE1262BL



HE1264BL

Gereedschapskasten met vleugeldeuren in zeer stabiele en zware uitvoering, geschikt voor intensief en industrieel gebruik. Constructie in plaatstaal 10/10mm met een poederlak coating in lichte hamerslag uitvoering.

- in de hoogte per 25mm verstelbare legborden (cap. 100kg)
- breedte 714mm, diepte 730mm en hoogte 700, 1000 of 1400mm
- centrale vergrendeling met een cilinderslot (+2 sleutels)

Order nr.		761000856	761000863	761000870
Orig. nr.		HE1261BL	HE1262BL	HE1264BL
Gewicht	kg	41,00	49,00	55,00
Afmetingen (l x b x h)	mm	714 x 730 x 700	714 x 730 x 1000	714 x 730 x 1400
Prijs	€	450,00	505,00	629,00



EQUIPMENT

Gereedschapskasten met vleugeldeuren in zeer stabiele en zware uitvoering, geschikt voor intensief en industrieel gebruik. Constructie in plaatstaal 10/10mm met een poederlak coating in lichte hamerslag uitvoering.

- in de hoogte per 25mm verstelbare legborden (cap. 100kg)
- breedte 714, diepte 730mm en hoogte 700, 1000 of 1400mm
- centrale vergrendeling met een cilinderslot (+2 sleutels)
- met uitschuifbare steunen of met cone-houders

Order nr.	Orig. nr.	Gewicht kg	Afmetingen (l x b x h) mm	Prijs €
761000857	HE12611BL	42,50	714 x 730 x 700	479,00
761000858	HE12612BL	51,00	714 x 730 x 700	575,00
761000859	HE12613BL	67,50	714 x 730 x 700	685,00
761000860	HE12614BL	76,00	714 x 730 x 700	765,00
761000861	HE12615BL	65,50	714 x 730 x 700	865,00
761000862	HE12616BL	74,00	714 x 730 x 700	955,00
761000864	HE12621BL	52,00	714 x 730 x 1000	565,00
761000865	HE12622BL	69,00	714 x 730 x 1000	769,00
761000866	HE12623BL	100,00	714 x 730 x 1000	915,00
761000867	HE12624BL	84,00	714 x 730 x 1000	819,00
761000868	HE12625BL	82,00	714 x 730 x 1000	1.015,00
761000869	HE12626BL	98,00	714 x 730 x 1000	1.245,00
761000871	HE12641BL	59,50	714 x 730 x 1400	715,00
761000872	HE12642BL	85,00	714 x 730 x 1400	985,00
761000873	HE12643BL	108,00	714 x 730 x 1400	1.049,00
761000874	HE12644BL	116,50	714 x 730 x 1400	1.145,00
761000875	HE12645BL	99,50	714 x 730 x 1400	1.385,00
761000876	HE12646BL	108,00	714 x 730 x 1400	1.455,00



HE12611BL

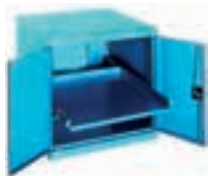

HE12612BL



HE12613BL



HE12614BL



HE12615BL



HE12616BL



HE12621BL



HE12622BL



HE12623BL



HE12624BL



HE12625BL



HE12626BL



HE12641BL



HE12642BL



HE12643BL



HE12644BL



HE12645BL



HE12646BL



Gereedschapskasten in zeer stabiele en zware uitvoering, geschikt voor intensief en industrieel gebruik. Constructie in plaatstaal 10/10mm met een poederlak coating in lichte hamerslag uitvoering.

- laden 90% uittrekbaar met een draagvermogen van 15kg
- in de hoogte per 25mm verstelbare legborden (cap. 100kg)

Order nr.	Orig. nr.	Omschrijving	Gewicht	Afmetingen	Prijs
			kg	(l x b x h) mm	
761001274	HE1544BL	muurkast	35,00	677 x 246 x 913	462,00
761001275	HE15445BL	kast + muurkast	33,50	677 x 400 x 1763	825,00
761001276	HE1545BL	kast	32,00	677 x 400 x 850	359,00



Gereedschapskasten in zeer stabiele en zware uitvoering, geschikt voor intensief en industrieel gebruik. Constructie in plaatstaal 10/10mm met een poederlak coating in lichte hamerslag uitvoering.

- laden 90% uittrekbaar met een draagvermogen van 15kg
- in de hoogte per 25mm verstelbare legborden (cap. 100kg)
- centrale vergrendeling met een cilinderslot (+2 sleutels)
- kunststof beschermingsmat
- deuren met afgeronde hoeken
- met voet of met wielen (2 vaste + 2 draaibare, waarvan 1 met rem)

Order nr.	Orig. nr.	Omschrijving	Gewicht	Afmetingen	Prijs
			kg	(l x b x h) mm	
761001260	HE1540BL	beschermingsmat	64,00	500 x 500 x 1050	549,00
761001261	HE1540PBL	beschermingsmat, voet	65,00	500 x 500 x 1125	615,00
761001262	HE1540RBL	beschermingsmat, nylon wielen	75,00	500 x 500 x 1185	715,00
761001263	HE1541BL	beschermingsmat	35,00	500 x 500 x 1050	313,00
761001265	HE1541PBL	beschermingsmat, voet	36,00	500 x 500 x 1125	369,00
761001266	HE1541RBL	beschermingsmat, nylon wielen	46,00	500 x 500 x 1185	460,00
761001267	HE1542BL	bovenaan openklapbaar	37,00	500 x 500 x 1250	381,00
761001268	HE1542PBL	bovenaan openklapbaar, voet	38,00	500 x 500 x 1325	402,00
761001269	HE1542RBL	bovenaan openklapbaar, nylon wielen	48,00	500 x 500 x 1385	525,00
761001270	HE1543BL	beschermingsmat	50,00	1000 x 500 x 1050	458,00
761001272	HE1543PBL	beschermingsmat, voet	52,00	1000 x 500 x 1125	489,00
761001273	HE1543RBL	beschermingsmat, nylon wielen	63,00	1000 x 500 x 1185	629,00



HE1571BL



HE1572BL



HE1573BL



HE1574BL



HE1575BL



HE1576BL



HE1577BL



HE1578BL

Gereedschapskasten met deuren in zeer stabiele en zware uitvoering, geschikt voor intensief en industrieel gebruik. Constructie in plaatstaal 10/10mm met een poederlak coating in lichte hamerslag uitvoering.

- laden 100% uittrekbaar met een draagvermogen van 50 kg
- centrale vergrendeling met een cilinderslot (+2 sleutels)



Order nr.	Orig. nr.	Gewicht kg	Afmetingen (l x b x h) mm	Prijs €
761001347	HE1571BL	50,00	500 x 500 x 1980	535,00
761001351	HE1572BL	42,00	500 x 500 x 1980	464,00
761001352	HE1573BL	17,70	500 x 500 x 1980	555,00
761001353	HE1574BL	72,50	500 x 500 x 1980	925,00
761001354	HE1575BL	73,00	500 x 500 x 1980	1.015,00
761001355	HE1576BL	80,00	500 x 500 x 1980	685,00
761001356	HE1577BL	45,00	500 x 500 x 1980	799,00
761001357	HE1578BL	70,00	500 x 500 x 1980	739,00
761001358	HE1579BL	52,00	500 x 500 x 1980	1.175,00
761001348	HE15710BL	65,50	500 x 500 x 1980	719,00
761001349	HE15711BL	68,00	500 x 500 x 1980	769,00
761001350	HE15712BL	63,50	500 x 500 x 1980	799,00

HECO



HE157CG

HE157CP

Opbergbakjes.

OOK IN ANDERE
KLEUREN BESCHIKBAAR

■ ORIG NR MET EXTENSIE GR
■ ORIG NR MET EXTENSIE RE

Order nr.	761001363	€	761001364	€
Orig. nr.	HE157CG		HE157CP	
Gewicht	kg	0,75	0,50	
Afmetingen (l x b x h)	mm	180 x 300 x 140	120 x 310 x 110	
Prijs	€	18,00	11,50	

HECO

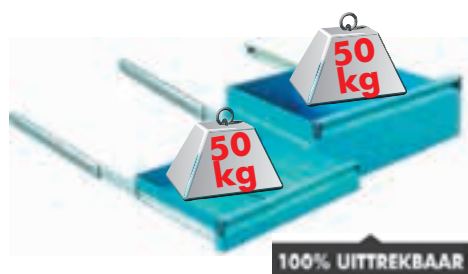

EQUIPMENT

Gereedschapskasten met deuren in zeer stabiele en zware uitvoering, geschikt voor intensief en industrieel gebruik. Constructie in plaatstaal 10/10mm met een poederlak coating in lichte hamerslag uitvoering.

- laden 100% uittrekbaar met een draagvermogen van 50kg
- centrale vergrendeling met een cilinderslot (+2 sleutels)

Order nr.	Orig. nr.	Gewicht kg	Afmetingen (l x b x h) mm	Prijs €
761001372	HE1581BL	64,50	700 x 500 x 1980	695,00
761001373	HE1582BL	83,50	700 x 500 x 1980	1.119,00
761001374	HE1583BL	105,00	700 x 500 x 1980	985,00
761001375	HE1584BL	87,00	700 x 500 x 1980	885,00
761001376	HE1585BL	108,00	700 x 500 x 1980	1.285,00
761001377	HE15861BL	81,50	700 x 500 x 1980	1.185,00
761001378	HE1587BL	84,00	700 x 500 x 1980	945,00
761001379	HE1588BL	83,00	700 x 500 x 1980	855,00
761001380	HE1589BL	85,00	700 x 500 x 1980	985,00



HE1581BL



HE1582BL

H200mm
H200mm
H200mm
H200mm
H200mm



HE1583BL

H200mm
H200mm
H200mm



HE1584BL

H200mm
H200mm



HE1585BL



HE15861BL

H200mm
H200mm



HE1587BL

H100mm
H100mm



HE1588BL

H200mm



HE1589BL

H100mm
H100mm
H200mm

EQUIPMENT



HECO

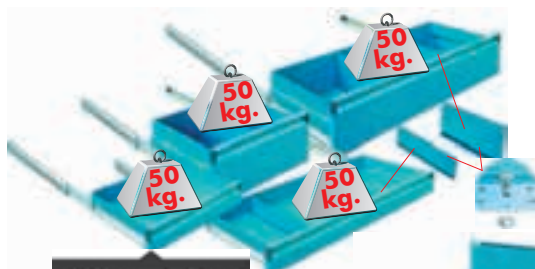

100% UITTREKBAAR



OOK IN ANDERE
KLEUREN BESCHIKBAAR

■ ORIG. NI MET EXTENSIE GR
■ ORIG. NI MET EXTENSIE RE



Gereedschapskasten met deuren in zeer stabiele en zware uitvoering, geschikt voor intensief en industrieel gebruik. Constructie in plaatstaal 10/10mm met een poederlak coating in lichte hamerslag uitvoering.

- laden 100% uittrekbaar met een draagvermogen van 50kg
- centrale vergrendeling met een cilinderslot (+2 sleutels)

Order nr.	Orig. nr.	Gewicht kg	Afmetingen (l x b x h) mm	Prijs €
761001395	HE1591BL	104,00	1000 x 490 x 1980	1.285,00
761001405	HE1592BL	87,50	1000 x 490 x 1980	745,00
761001406	HE1593BL	95,00	1000 x 490 x 1980	999,00
761001408	HE1594BL	81,00	1000 x 490 x 1980	819,00
761001409	HE15951BL	91,00	1000 x 490 x 1980	1.265,00
761001410	HE159515BL	91,00	1000 x 490 x 1980	1.235,00
761001411	HE15961BL	91,50	1000 x 490 x 1980	1.175,00
761001412	HE1597BL	90,50	1000 x 490 x 1980	985,00
761001413	HE1598BL	116,50	1000 x 490 x 1980	1.305,00
761001414	HE1599BL	120,00	1000 x 490 x 1980	1.515,00
761001396	HE15910BL	95,50	1000 x 490 x 1980	1.085,00
761001397	HE15911BL	106,00	1000 x 490 x 1980	1.045,00
761001398	HE15912BL	118,00	1000 x 490 x 1980	1.369,00
761001399	HE15913BL	112,00	1000 x 490 x 1980	1.265,00
761001400	HE15914BL	122,50	1000 x 490 x 1980	1.475,00
761001401	HE15915BL	144,50	1000 x 490 x 1980	1.665,00
761001402	HE15916BL	110,00	1000 x 490 x 1980	1.075,00
761001403	HE15917BL	110,00	1000 x 490 x 1980	1.075,00
761001404	HE15918BL	110,00	1000 x 490 x 1980	1.075,00



HE1591BL

H200mm
H200mm
H200mm
H200mm
H200mm



HE1592BL



HE1593BL

H200mm



HE1594BL



HE15951BL

H200mm



HE15961BL

H200mm
H200mm



HE1597BL



HE1598BL

H200mm



HE1599BL



HE1599CPBL



HE1599CGBL



HE15910BL

H100mm
H100mm
H200mm



HE15911BL

H100mm
H100mm



HE15912BL

H100mm
H100mm
H200mm
H200mm
H200mm



HE15913BL

H100mm
H200mm



HE15914BL

H100mm
H200mm



HE15915BL

H100mm
H200mm



HE15916BL

H200mm



HE15917BL

H200mm



HE15918BL

H200mm



HE159B1



HE159B2



HE159B3



HE159B4



HE159B5



HE159B6



HE159B7

EQUIPMENT

Gereedschapskasten met deuren in zeer stabiele en zware uitvoering, geschikt voor intensief en industrieel gebruik. Constructie in plaatstaal 10/10mm met een poederlak coating in lichte hamerslag uitvoering.

- laden 100% uittrekbaar met een draagvermogen van 50kg
- centrale vergrendeling met een cilinderslot (+2 sleutels)

Order nr.	Orig. nr.	Omschrijving	Gewicht kg	Afmetingen (l x b x h) mm	Prijs €
761001416	HE159B1BL	met 2 legborden	41,50	1000 x 490 x 1000	545,00
761001417	HE159B2BL	met 2 laden	55,50	1000 x 490 x 1000	815,00
761001418	HE159B3BL	met 1 lade	51,50	1000 x 490 x 1000	745,00
761001419	HE159B4BL	met 24 bakjes	53,50	1000 x 490 x 1000	825,00
761001420	HE159B5BL	met 3 laden	63,00	1000 x 490 x 1000	965,00
761001421	HE159B6BL	met 1 lade	48,00	1000 x 490 x 1000	715,00
761001422	HE159B7BL	met 6 laden	73,00	1000 x 490 x 1000	1.149,00
761001423	HE159B8BL	met 5 laden	71,50	1000 x 490 x 1000	1.065,00
761001424	HE159B9BL	met 3 laden	60,50	1000 x 490 x 1000	885,00



Hoekkast zonder legbord voor kasten 157/158/159C.

toepassing

Order nr.		761001436
Orig. nr.		HE159CABL
Gewicht	kg	102,00
Afmetingen (l x b x h)	mm	625 x 490 x 1980
Prijs	€	1.015,00



Stootbaar voor kasten HE159.

Order nr.		761001451
Orig. nr.		HE159TCBL
Gewicht	kg	0,01
Prijs	€	14,50



Legbord voor hoekkast HE159CA.

Order nr.		761001437
Orig. nr.		HE159CABBL
Gewicht	kg	7,00
Prijs	€	59,50

HECO



HE157C1BL



HE157C2BL



HE157C3BL



HE157CBL



HE157C4BL



HE157C5BL



HE157C6BL

Gereedschapskasten met deuren in zeer stabiele en zware uitvoering, geschikt voor intensief en industrieel gebruik. Constructie in plaatstaal 10/10mm met een poederlak coating in lichte hamerslag uitvoering. Met geperforeerde achterwand voor montage van plastic bakjes.

- voorzien van bakjes, behalve HE157C
- centrale vergrendeling met een cilinderslot (+2 sleutels)

Order nr.	Orig. nr.	Omschrijving	Gewicht kg	Afmetingen (l x b x h) mm	Prijs €
761001361	HE157CBL	zonder bakjes	32,00	500 x 260 x 1980	446,00
761001362	HE157C1BL	24x0,4L + 16x1,2L + 12x3,5L	46,00	500 x 260 x 1980	529,00
761002074	HE157C2BL	20x0,4L + 36x1,2L + 6x3,5L	46,50	500 x 260 x 1980	555,00
761002075	HE157C3BL	12x0,4L + 40x1,2L + 6x3,5L	46,50	500 x 260 x 1980	555,00
761002076	HE157C4BL	100x0,4L	45,00	500 x 260 x 1980	529,00
761002077	HE157C5BL	52x1,2L	46,00	500 x 260 x 1980	545,00
761002078	HE157C6BL	27x3,5L	46,50	500 x 260 x 1980	555,00



HE158CBL



HE158C1 BL



HE158C2BL



HE158C3BL



HE158C4BL



HE158C5BL



HE158C6BL



Gereedschapskasten met deuren in zeer stabiele en zware uitvoering, geschikt voor intensief en industrieel gebruik. Constructie in plaatstaal 10/10mm met een poederlak coating in lichte hamerslag uitvoering. Met geperforeerde achterwand voor montage van plastic bakjes.

- voorzien van bakjes, behalve HE158C
- centrale vergrendeling met een cilinderslot (+2 sleutels)

Order nr.	Orig. nr.	Omschrijving	Gewicht kg	Afmetingen (l x b x h) mm	Prijs €
761001383	HE158CBL	zonder bakjes	56,00	700 x 260 x 1980	535,00
761001384	HE158C1BL	36x0,4L + 24x1,2L + 16x3,5L	58,00	700 x 260 x 1980	665,00
761002080	HE158C2BL	30x0,4L + 54x1,2L + 8x3,5L	59,50	700 x 260 x 1980	625,00
761002081	HE158C3BL	18x0,4L + 60x1,2L + 8x3,5L	59,50	700 x 260 x 1980	629,00
761002082	HE158C4BL	150x0,4L	57,00	700 x 260 x 1980	605,00
761002083	HE158C5BL	78x1,2L	59,00	700 x 260 x 1980	615,00
761002084	HE158C6BL	36x3,5L	58,50	700 x 260 x 1980	615,00



HE159CBL



HE159C1BL



HE159C2BL



HE159C3BL



HE159C4BL



HE159C5BL



HE159C6BL

Gereedschapskasten met deuren in zeer stabiele en zware uitvoering, geschikt voor intensief en industrieel gebruik. Constructie in plaatstaal 10/10mm met een poederlak coating in lichte hamerslag uitvoering.

- voorzien van bakjes, behalve HE159C
- centrale vergrendeling met een cilinderslot (+2 sleutels)

Order nr.	Orig. nr.	Omschrijving	Gewicht kg	Afmetingen (l x b x h) mm	Prijs €
761001429	HE159CBL	zonder bakjes	70,00	1000 x 260 x 1980	625,00
761001430	HE159C1BL	54x0,4L + 36x1,2L + 24x3,5L	82,00	1000 x 260 x 1980	785,00
761001431	HE159C2BL	45x0,4L + 81x1,2L + 12x3,5L	84,00	1000 x 260 x 1980	805,00
761001432	HE159C3BL	27x0,4L + 90x1,2L + 12x3,5L	84,00	1000 x 260 x 1980	805,00
761001433	HE159C4BL	225x0,4L	81,00	1000 x 260 x 1980	765,00
761001434	HE159C5BL	117x1,2L	83,00	1000 x 260 x 1980	789,00
761001435	HE159C6BL	54x3,5L	82,50	1000 x 260 x 1980	789,00

OOK IN ANDERE
KLEUREN BESCHIKBAAR

■ ORIG NR MET EXTENSIE GE
■ ORIG NR MET EXTENSIE RE



HE159P1BL



HE159P2BL



HE159P3BL



HE159P4BL



HE159P5BL



HE159P6BL



HE159PB1BL

Gereedschapskasten in zeer stabiele en zware uitvoering, geschikt voor intensief en industrieel gebruik. Constructie in plaatstaal 10/10mm met een poederlak coating in lichte hamerslag uitvoering.

- laden 100% uittrekbaar met een draagvermogen van 50kg

Order nr.	Orig. nr.	Gewicht kg	Afmetingen (l x b x h) mm	Prijs €
761002089	HE159P1BL	116,00	1005 x 500 x 1980	1.469,00
761002090	HE159P2BL	119,00	1005 x 500 x 1980	1.545,00
761002091	HE159P3BL	101,00	1005 x 500 x 1980	1.005,00
761002092	HE159P4BL	111,00	1005 x 500 x 1980	1.309,00
761002093	HE159P5BL	114,00	1005 x 500 x 1980	1.105,00
761002094	HE159P6BL	112,00	1005 x 500 x 1980	1.209,00
761002096	HE159PB1BL	67,00	1005 x 500 x 1000	949,00
761002097	HE159PB2BL	64,00	1005 x 500 x 1000	859,00
761002098	HE159PB3BL	52,00	1005 x 500 x 1000	679,00



Vestiaire kasten in zeer stabiele en zware uitvoering, geschikt voor intensief en industrieel gebruik. Constructie in plaatstaal 10/10mm met een poederlak coating in lichte hamerslag uitvoering.

- type HE155 400mm breed, type HE156 300mm breed

Order nr.	Orig. nr.	Gewicht kg	Deuren	Prijs €
761001309	HE15611BL	28,00	1	262,00
761001279	HE15511BL	30,00	1	284,00
761001314	HE15612BL	25,00	1	236,00
761001284	HE15512BL	27,00	1	259,00
761001310	HE156112BL	53,00	1	485,00
761001280	HE155112BL	57,00	1	535,00
761001311	HE156113BL	81,00	1	709,00
761001281	HE155113BL	91,50	1	765,00
761001312	HE156114BL	111,00	1	935,00
761001282	HE155114BL	122,00	1	1.025,00
761001313	HE156115BL	141,00	1	1.165,00
761001283	HE155115BL	154,00	1	1.275,00
761001315	HE15621BL	29,00	2	302,00
761001285	HE15521BL	31,00	2	328,00
761001320	HE15622BL	26,00	2	276,00
761001290	HE15522BL	28,00	2	302,00
761001316	HE156212BL	55,00	2	565,00
761001286	HE155212BL	59,00	2	635,00
761001317	HE156213BL	89,00	2	855,00
761001287	HE155213BL	94,50	2	935,00
761001318	HE156214BL	115,00	2	1.125,00
761001288	HE155214BL	126,00	2	1.235,00
761001319	HE156215BL	146,00	2	1.375,00
761001289	HE155215BL	159,00	2	1.485,00
761001321	HE1562P1BL	30,30	2	298,00
761001291	HE1552P1BL	32,00	2	322,00
761001326	HE1562P2BL	27,30	2	255,00
761001296	HE1552P2BL	29,00	2	297,00
761001322	HE1562P12BL	57,60	2	555,00
761001292	HE1552P12BL	61,00	2	625,00
761001323	HE1562P13BL	84,90	2	839,00
761001293	HE1552P13BL	90,90	2	925,00
761001324	HE1562P14BL	111,20	2	1.105,00
761001294	HE1552P14BL	123,70	2	1.215,00
761001325	HE1562P15BL	138,50	2	1.355,00
761001295	HE1552P15BL	141,50	2	1.455,00
761001327	HE15631BL	30,00	3	368,00
761001297	HE15531BL	31,00	3	390,00
761001332	HE15632BL	27,00	3	341,00
761001302	HE15532BL	28,00	3	361,00
761001328	HE156312BL	57,00	3	715,00
761001298	HE155312BL	59,00	3	769,00
761001329	HE156313BL	87,00	3	999,00
761001299	HE155313BL	94,50	3	1.075,00
761001330	HE156314BL	119,00	3	1.295,00
761001300	HE155314BL	126,00	3	1.395,00
761001331	HE156315BL	151,00	3	1.645,00
761001301	HE155315BL	159,00	3	1.739,00
761001333	HE15641BL	30,00	4	358,00
761001303	HE15541BL	33,00	4	386,00
761001338	HE15642BL	30,00	4	333,00
761001308	HE15542BL	30,00	4	361,00
761001334	HE156412BL	57,00	4	699,00
761001304	HE155412BL	63,00	4	759,00
761001335	HE156413BL	87,00	4	975,00
761001305	HE155413BL	101,00	4	1.065,00
761001336	HE156414BL	119,00	4	1.265,00
761001306	HE155414BL	134,00	4	1.375,00
761001337	HE156415BL	151,00	4	1.605,00
761001307	HE155415BL	169,00	4	1.745,00

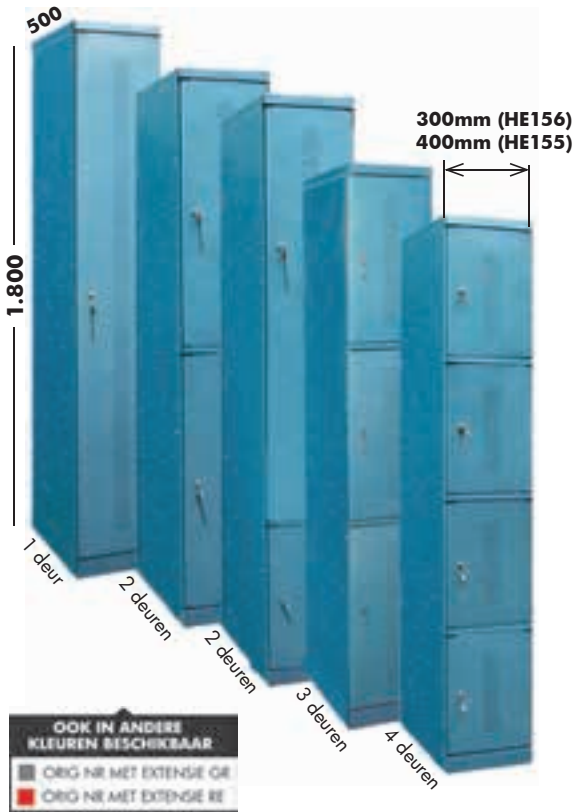

etikettenhouders



deuren geperforeerd voor verlichting binnenin.
180° openen mogelijk door afgeronde hoeken



versterkte deuren



HE15611BL
HE15511BL



HE15612BL
HE15512BL

1 DEUR



HE156112BL
HE155112BL



HE156113BL
HE155113BL



HE156114BL
HE155114BL



HE156115BL
HE155115BL



HE15621BL
HE15521BL



HE15622BL
HE15522BL

2 DEUREN



HE156212BL
HE155212BL



HE156213BL
HE155213BL



HE156214BL
HE155214BL

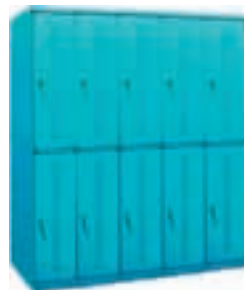

HE156215BL
HE155215BL

EQUIPMENT

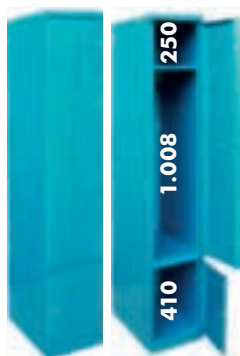

HE1562P1BL
HE1552P1BL



HE1562P2BL
HE1552P2BL

2 DEUREN



HE1562P12BL
HE1552P12BL



HE1562P13BL
HE1552P13BL



HE1562P14BL
HE1552P14BL



HE1562P15BL
HE1552P15BL

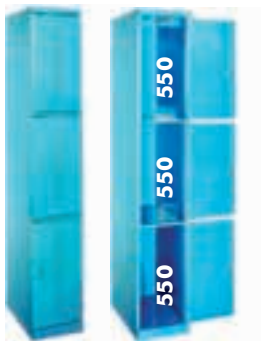

HE15631BL
HE15531BL



HE15632BL
HE15532BL

3 DEUREN



HE156312BL
HE155312BL



HE156313BL
HE155313BL



HE156314BL
HE155314BL



HE156315BL
HE155315BL

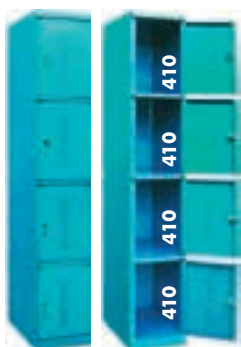

HE15641BL
HE15541BL



HE15642BL
HE15542BL

4 DEUREN



HE156412BL
HE155412BL



HE156413BL
HE155413BL



HE156414BL
HE155414BL



HE156415BL
HE155415BL



Locker bank.

Order nr.		761001339	761001340	761001341
Orig. nr.		HE156BV10BL	HE156BV15BL	HE156BV20BL
Gewicht	kg	11,00	19,00	23,00
Afmetingen (l x b x h)	mm	900 x 320 x 480	1500 x 320 x 480	2000 x 320 x 480
Prijs	€	183,00	294,00	366,00



Vestiaire kasten in zeer stabiele en zware uitvoering, geschikt voor intensief en industrieel gebruik. Constructie in plaatstaal 10/10mm met een poederlak coating in lichte hamerslag uitvoering. Met afgeschuind dak.

Order nr.	Orig. nr.	Aantal deuren	Gewicht kg	Afmetingen (l x b x h) mm	Prijs €
761001458	HE1608TIBL	6	71,00	800 x 500 x 1890	1.045,00
761002106	HE160102TIBL	10	76,00	800 x 500 x 1890	1.125,00
761001454	HE160122TIBL	12	76,00	800 x 500 x 1890	1.175,00
761002105	HE160101TIBL	10	54,00	500 x 500 x 1890	805,00
761001453	HE160121TIBL	12	54,00	500 x 500 x 1890	845,00
761002107	HE160161TIBL	16	74,00	500 x 500 x 2375	1.175,00



Vestiaire kasten in zeer stabiele en zware uitvoering, geschikt voor intensief en industrieel gebruik. Constructie in plaatstaal 10/10mm met een poederlak coating in lichte hamerslag uitvoering. Met afgeschuind dak en klep om kledij in de kast te gooien.

Order nr.	Orig. nr.	Gewicht kg	Afmetingen (l x b x h) mm	Prijs €
761001452	HE1600BL	28,50	400 x 500 x 1890	322,00
761001455	HE1601TIBL	58,00	800 x 900 x 2280	655,00

PC kasten

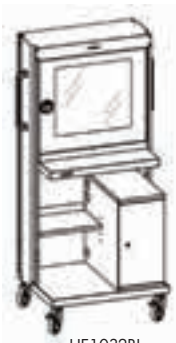

HE1032BL



HE1033BL



HE1034BL

NEW



HE10331

EQUIPMENT

- Modulaire kast voor PC.
- voor platte schermen tot 23"
 - richt uw kast volgens uw behoeften in
 - Verkrijgbaar met of zonder wielen
 - Verkrijgbaar met elektrische aansluitingen en data
 - Kleur op aanvraag

Order nr.		761013567	761013568	761013569	761013570
Orig. nr.	mm	HE1031BL	HE1032BL	HE1033BL	HE1034BL
Afmetingen (l x b x h)		895 x 860 x 1735	895 x 860 x 1735	895 x 860 x 1735	895 x 860 x 1735
Prijs	€	1.495,00	1.385,00	1.145,00	689,00

HECO



700x714mm



1400x1020mm



1000x714mm



700x600mm



1400x714mm



1000x600mm



700x1020mm



1400x600mm



1000x1020mm

HECO, PROUD SPONSOR OF THE GP3 CHAMPIONSHIP



zeer goede inkijk op de lade inhoud

gegroefd binnenin voor ladeverdeling

etikettenhouder

polypropeen bescherming



centrale vergrendeling



anti-omkeer mechanisme





Heco ladenkasten 700x714mm



Ladenkasten in zeer stabiele en zware uitvoering, geschikt voor intensief en industrieel gebruik. Constructie in plaatstaal 10/10mm (kast) en 15/10mm (laden)..

- breedte 714mm, en hoogte 700mm
- centrale vergrendeling met een cilinderslot (+2 sleutels)
- zeer hoogwaardige lagergeleidingen
- 1-lade uittrekbeveiliging voorkomt omkantelen
- verschillende compartimenten en lade-indelingen mogelijk
- Diepte 707mm of 600mm mogelijk
- Afwerking: blauwe poederlak coating in lichte hamerslag uitvoering



Verskillende mogelijke laden:

- Laden 100% uittrekbaar met een draagvermogen van 50kg
- Laden 90% uittrekbaar met een draagvermogen van 100kg
- Laden 100% uittrekbaar met een draagvermogen van 100kg
- Laden 100% uittrekbaar met een draagvermogen van 200kg

Order nr.	Orig. nr.	Uittrekbaar	Capaciteit lades	Aantal laden	Gewicht	Afmetingen (l x b x h)	Prijs €
		%	kg		kg	mm	
761000322	HE115101BL	100	50	3	70,50	714 x 707 x 700	859,00
761000323	HE115102BL	100	50	4	77,00	714 x 707 x 700	975,00
761000324	HE115103BL	100	50	4	76,00	714 x 707 x 700	979,00
761000325	HE115104BL	100	50	4	74,00	714 x 707 x 700	975,00
761000326	HE115105BL	100	50	4	75,00	714 x 707 x 700	975,00
761000327	HE115106BL	100	50	5	80,00	714 x 707 x 700	1.095,00
761000328	HE115107BL	100	50	5	79,00	714 x 707 x 700	1.099,00
761000329	HE115108BL	100	50	6	84,00	714 x 707 x 700	1.215,00
761000330	HE115109BL	100	50	8	90,00	714 x 707 x 700	1.429,00
761000331	HE115111BL	90	100	3	81,50	714 x 707 x 700	849,00
761000332	HE115112BL	90	100	4	89,00	714 x 707 x 700	959,00
761000333	HE115113BL	90	100	4	92,00	714 x 707 x 700	965,00
761000334	HE115114BL	90	100	4	87,00	714 x 707 x 700	949,00
761000335	HE115115BL	90	100	4	89,50	714 x 707 x 700	955,00
761000336	HE115116BL	90	100	5	96,00	714 x 707 x 700	1.059,00
761000337	HE115117BL	90	100	5	96,00	714 x 707 x 700	1.065,00
761000338	HE115118BL	90	100	6	105,00	714 x 707 x 700	1.175,00
761000339	HE115119BL	90	100	8	102,00	714 x 707 x 700	1.365,00
761000340	HE115121BL	100	100	3	85,50	714 x 707 x 700	965,00
761000341	HE115122BL	100	100	4	96,00	714 x 707 x 700	1.115,00
761000342	HE115123BL	100	100	4	96,00	714 x 707 x 700	1.115,00
761000343	HE115124BL	100	100	4	95,00	714 x 707 x 700	1.105,00
761000344	HE115125BL	100	100	5	103,50	714 x 707 x 700	1.245,00
761000352	HE115126BL	100	100	5	104,50	714 x 707 x 700	1.255,00
761000353	HE115127BL	100	100	5	105,50	714 x 707 x 700	1.255,00
761000354	HE115128BL	100	100	6	117,00	714 x 707 x 700	1.405,00
761000355	HE115129BL	100	100	8	130,00	714 x 707 x 700	1.655,00
761000356	HE115131BL	100	200	3	100,00	714 x 707 x 700	995,00
761000357	HE115132BL	100	200	4	113,00	714 x 707 x 700	1.155,00
761000358	HE115133BL	100	200	4	114,00	714 x 707 x 700	1.159,00
761000359	HE115134BL	100	200	4	112,00	714 x 707 x 700	1.145,00
761000360	HE115135BL	100	200	4	112,50	714 x 707 x 700	1.155,00
761000361	HE115136BL	100	200	5	125,50	714 x 707 x 700	1.305,00
761000362	HE115137BL	100	200	5	125,50	714 x 707 x 700	1.315,00
761000363	HE115138BL	100	200	6	138,00	714 x 707 x 700	1.449,00
761000364	HE115139BL	100	200	8	162,00	714 x 707 x 700	1.745,00
761001950	HE122111BL	90	100	3	54,50	714 x 600 x 700	765,00
761001951	HE122112BL	90	100	4	61,00	714 x 600 x 700	855,00
761001952	HE122113BL	90	100	4	61,00	714 x 600 x 700	865,00
761001953	HE122114BL	90	100	4	61,00	714 x 600 x 700	855,00
761001954	HE122115BL	90	100	4	61,00	714 x 600 x 700	859,00
761001955	HE122116BL	90	100	5	67,00	714 x 600 x 700	955,00
761001956	HE122117BL	90	100	5	67,00	714 x 600 x 700	955,00
761001957	HE122118BL	90	100	6	73,00	714 x 600 x 700	1.045,00
761001958	HE122119BL	90	100	8	85,00	714 x 600 x 700	1.225,00

3 laden



H150mm
H200mm
H250mm

HE115101 - HE115111
HE115121 - HE115131
HE122111

4 laden



H100mm
H100mm
H200mm
H200mm

HE115102 - HE115112
HE115122 - HE115132
HE122112

4 laden



H150mm
H150mm
H150mm
H150mm

HE115103 - HE115113
HE115123 - HE115133
HE122113

4 laden



H75mm
H75mm
H200mm
H250mm

HE115104 - HE115114
HE115124 - HE115134
HE122114

4 laden



H100mm
H100mm
H150mm
H250mm

HE115105 - HE115115
HE115125 - HE115135
HE122115

5 laden



H75mm
H75mm
H100mm
H150mm
H200mm

HE115106 - HE115116
HE115126 - HE115136
HE122116

5 laden



H75mm
H100mm
H100mm
H125mm
H200mm

HE115107 - HE115117
HE115127 - HE115137
HE122117

6 laden



H100mm
H100mm
H100mm
H100mm
H100mm
H100mm

HE115108 - HE115118
HE115128 - HE115138
HE122118

8 laden



H75mm
H75mm
H75mm
H75mm
H75mm
H75mm
H75mm
H75mm

HE115109 - HE115119
HE115129 - HE115139
HE122119



Assortiment onderverdelingen vanaf p. 489



Ladenkasten in zeer stabiele en zware uitvoering, geschikt voor intensief en industrieel gebruik. Constructie in plaatstaal 10/10mm (kast) en 15/10mm (laden)..

- breedte 714mm, en hoogte 700mm
- centrale vergrendeling met een cilinderslot (+2 sleutels)
- zeer hoogwaardige lagergeleidingen
- 1-lade uittrekbeveiliging voorkomt omkantelen
- verschillende compartimenten en lade-indelingen mogelijk
- Diepte 707mm of 600mm mogelijk
- Afwerking: rode poederlak coating in lichte hamerslag uitvoering

Verskillende mogelijke laden:

- Laden 100% uittrekbaar met een draagvermogen van 50kg
- Laden 90% uittrekbaar met een draagvermogen van 100kg
- Laden 100% uittrekbaar met een draagvermogen van 100kg
- Laden 100% uittrekbaar met een draagvermogen van 200kg



Order nr.	Orig. nr.	Uittrekbaar %	Capaciteit lades kg	Aantal laden	Gewicht kg	Afmetingen (l x b x h) mm	Prijs €
761020322	HE115101RE	100	50	3	70,50	714 x 707 x 700	859,00
761020323	HE115102RE	100	50	4	77,00	714 x 707 x 700	975,00
761020324	HE115103RE	100	50	4	76,00	714 x 707 x 700	979,00
761020325	HE115104RE	100	50	4	74,00	714 x 707 x 700	975,00
761020326	HE115105RE	100	50	4	75,00	714 x 707 x 700	975,00
761020327	HE115106RE	100	50	5	80,00	714 x 707 x 700	1.095,00
761020328	HE115107RE	100	50	5	79,00	714 x 707 x 700	1.099,00
761020329	HE115108RE	100	50	6	84,00	714 x 707 x 700	1.215,00
761020330	HE115109RE	100	50	8	90,00	714 x 707 x 700	1.429,00
761003585	HE115111RE	90	100	3	81,50	714 x 707 x 700	849,00
761003586	HE115112RE	90	100	4	89,00	714 x 707 x 700	959,00
761003587	HE115113RE	90	100	4	92,00	714 x 707 x 700	965,00
761003588	HE115114RE	90	100	4	87,00	714 x 707 x 700	949,00
761003589	HE115115RE	90	100	4	89,50	714 x 707 x 700	955,00
761003590	HE115116RE	90	100	5	96,00	714 x 707 x 700	1.059,00
761003591	HE115117RE	90	100	5	96,00	714 x 707 x 700	1.065,00
761003592	HE115118RE	90	100	6	105,00	714 x 707 x 700	1.175,00
761003593	HE115119RE	90	100	8	102,00	714 x 707 x 700	1.365,00
761020340	HE115121RE	100	100	3	85,50	714 x 707 x 700	965,00
761020341	HE115122RE	100	100	4	96,00	714 x 707 x 700	1.115,00
761020342	HE115123RE	100	100	4	96,00	714 x 707 x 700	1.115,00
761020343	HE115124RE	100	100	4	95,00	714 x 707 x 700	1.105,00
761020344	HE115125RE	100	100	5	103,50	714 x 707 x 700	1.245,00
761020352	HE115126RE	100	100	-	104,50	714 x 707 x 700	1.255,00
761020353	HE115127RE	100	100	5	105,50	714 x 707 x 700	1.255,00
761020354	HE115128RE	100	100	6	117,00	714 x 707 x 700	1.405,00
761020355	HE115129RE	100	100	8	130,00	714 x 707 x 700	1.655,00
761020356	HE115131RE	100	200	3	100,00	714 x 707 x 700	995,00
761020357	HE115132RE	100	200	4	113,00	714 x 707 x 700	1.155,00
761020358	HE115133RE	100	200	4	114,00	714 x 707 x 700	1.159,00
761020359	HE115134RE	100	200	4	112,00	714 x 707 x 700	1.145,00
761020360	HE115135RE	100	200	4	112,50	714 x 707 x 700	1.155,00
761020361	HE115136RE	100	200	5	125,50	714 x 707 x 700	1.305,00
761020362	HE115137RE	100	200	5	125,50	714 x 707 x 700	1.315,00
761020363	HE115138RE	100	200	6	138,00	714 x 707 x 700	1.449,00
761020364	HE115139RE	100	200	8	162,00	714 x 707 x 700	1.745,00
761021950	HE122111RE	90	100	3	54,50	714 x 600 x 700	765,00
761021951	HE122112RE	90	100	4	61,00	714 x 600 x 700	855,00
761021952	HE122113RE	90	100	4	61,00	714 x 600 x 700	855,00
761021953	HE122114RE	90	100	4	61,00	714 x 600 x 700	855,00
761021954	HE122115RE	90	100	4	61,00	714 x 600 x 700	859,00
761021955	HE122116RE	90	100	4	61,00	714 x 600 x 700	955,00
761021956	HE122117RE	90	100	5	67,00	714 x 600 x 700	955,00
761021957	HE122118RE	90	100	5	67,00	714 x 600 x 700	1.045,00
761021958	HE122119RE	90	100	6	67,00	714 x 600 x 700	1.225,00



Ladenkasten in zeer stabiele en zware uitvoering, geschikt voor intensief en industrieel gebruik. Constructie in plaatstaal 10/10mm (kast) en 15/10mm (laden)..

- breedte 714mm, en hoogte 700mm
- centrale vergrendeling met een cilinderslot (+2 sleutels)
- zeer hoogwaardige lagergeleidingen
- 1-lade uittrekbeveiliging voorkomt omkantelen
- verschillende compartimenten en lade-indelingen mogelijk
- Diepte 707mm of 600mm mogelijk
- Afwerking: Grijs poederlak coating in lichte hamerslag uitvoering



Verschillende mogelijke laden:

- Laden 100% uittrekbaar met een draagvermogen van 50kg
- Laden 90% uittrekbaar met een draagvermogen van 100kg
- Laden 100% uittrekbaar met een draagvermogen van 100kg
- Laden 100% uittrekbaar met een draagvermogen van 200kg

Order nr.	Orig. nr.	Uittrekbaar	Capaciteit lades	Aantal laden	Gewicht	Afmetingen (l x b x h)	Prijs
		%	kg				
761010322	HE115101GR	100	50	3	70,50	714 x 707 x 700	859,00
761010323	HE115102GR	100	50	4	77,00	714 x 707 x 700	975,00
761010324	HE115103GR	100	50	4	76,00	714 x 707 x 700	979,00
761010325	HE115104GR	100	50	4	74,00	714 x 707 x 700	975,00
761010326	HE115105GR	100	50	4	75,00	714 x 707 x 700	975,00
761010327	HE115106GR	100	50	5	80,00	714 x 707 x 700	1.095,00
761010329	HE115108GR	100	50	6	84,00	714 x 707 x 700	1.215,00
761010328	HE115107GR	100	50	5	79,00	714 x 707 x 700	1.099,00
761010330	HE115109GR	100	50	8	90,00	714 x 707 x 700	1.429,00
761003567	HE115111GR	90	100	3	81,50	714 x 707 x 700	849,00
761003568	HE115112GR	90	100	4	89,00	714 x 707 x 700	959,00
761003569	HE115113GR	90	100	4	92,00	714 x 707 x 700	965,00
761003570	HE115114GR	90	100	4	87,00	714 x 707 x 700	949,00
761003571	HE115115GR	90	100	4	89,50	714 x 707 x 700	955,00
761021964	HE115116GR	90	100	5	96,00	714 x 707 x 700	1.059,00
761021965	HE115117GR	90	100	5	96,00	714 x 707 x 700	1.065,00
761021966	HE115118GR	90	100	6	105,00	714 x 707 x 700	1.175,00
761021967	HE115119GR	90	100	8	102,00	714 x 707 x 700	1.365,00
761010340	HE115121GR	100	100	3	85,50	714 x 707 x 700	965,00
761010341	HE115122GR	100	100	4	96,00	714 x 707 x 700	1.115,00
761010342	HE115123GR	100	100	4	96,00	714 x 707 x 700	1.115,00
761010343	HE115124GR	100	100	4	95,00	714 x 707 x 700	1.105,00
761010344	HE115125GR	100	100	5	103,50	714 x 707 x 700	1.245,00
761010352	HE115126GR	100	100	-	104,50	714 x 707 x 700	1.255,00
761010353	HE115127GR	100	100	5	105,50	714 x 707 x 700	1.255,00
761010354	HE115128GR	100	100	6	117,00	714 x 707 x 700	1.405,00
761010355	HE115129GR	100	100	8	130,00	714 x 707 x 700	1.655,00
761010356	HE115131GR	100	200	3	100,00	714 x 707 x 700	995,00
761010357	HE115132GR	100	200	4	113,00	714 x 707 x 700	1.155,00
761010358	HE115133GR	100	200	4	114,00	714 x 707 x 700	1.159,00
761010359	HE115134GR	100	200	4	112,00	714 x 707 x 700	1.145,00
761010360	HE115135GR	100	200	4	112,50	714 x 707 x 700	1.155,00
761010361	HE115136GR	100	200	5	125,50	714 x 707 x 700	1.305,00
761010362	HE115137GR	100	200	5	125,50	714 x 707 x 700	1.315,00
761010363	HE115138GR	100	200	6	138,00	714 x 707 x 700	1.449,00
761010364	HE115139GR	100	200	8	162,00	714 x 707 x 700	1.745,00
761011950	HE122111GR	90	100	3	54,50	714 x 600 x 700	765,00
761011951	HE122112GR	90	100	4	61,00	714 x 600 x 700	855,00
761011952	HE122113GR	90	100	4	61,00	714 x 600 x 700	855,00
761011953	HE122114GR	90	100	4	61,00	714 x 600 x 700	855,00
761011954	HE122115GR	90	100	4	61,00	714 x 600 x 700	859,00
761011955	HE122116GR	90	100	5	61,00	714 x 600 x 700	955,00
761011956	HE122117GR	90	100	5	67,00	714 x 600 x 700	955,00
761011957	HE122118GR	90	100	6	67,00	714 x 600 x 700	1.045,00
761011958	HE122119GR	90	100	8	67,00	714 x 600 x 700	1.225,00

Heco ladenkasten 1000x714mm



Ladenkasten in zeer stabiele en zware uitvoering, geschikt voor intensief en industrieel gebruik. Constructie in plaatstaal 10/10mm (kast) en 15/10mm (laden)..

- breedte 714mm, en hoogte 1000mm
- centrale vergrendeling met een cilinderslot (+2 sleutels)
- zeer hoogwaardige lagergeleidingen
- 1-lade uittrekbeveiliging voorkomt omkantelen
- verschillende compartimenten en lade-indelingen mogelijk
- Diepte 707mm of 600mm mogelijk
- Afwerking: blauwe poederlak coating in lichte hamerslag uitvoering

Verschillende mogelijke laden:

- Laden 100% uittrekbaar met een draagvermogen van 50kg
- Laden 90% uittrekbaar met een draagvermogen van 100kg
- Laden 100% uittrekbaar met een draagvermogen van 100kg
- Laden 100% uittrekbaar met een draagvermogen van 200kg



Order nr.	Orig. nr.	Uittrekbaar %	Capaciteit lades kg	Aantal laden	Gewicht kg	Afmetingen (l x b x h) mm	Prijs €
761000380	HE115201BL	100	50	5	94,00	714 x 707 x 1000	1.205,00
761000381	HE115202BL	100	50	6	98,00	714 x 707 x 1000	1.325,00
761000382	HE115203BL	100	50	6	100,00	714 x 707 x 1000	1.325,00
761000383	HE115204BL	100	50	7	101,50	714 x 707 x 1000	1.425,00
761000384	HE115205BL	100	50	8	107,00	714 x 707 x 1000	1.539,00
761000385	HE115206BL	100	50	9	111,00	714 x 707 x 1000	1.655,00
761000386	HE115207BL	100	50	9	112,00	714 x 707 x 1000	1.655,00
761000387	HE115208BL	100	50	11	118,00	714 x 707 x 1000	1.885,00
761000388	HE115209BL	100	50	12	121,00	714 x 707 x 1000	2.005,00
761000389	HE115211BL	90	100	5	111,50	714 x 707 x 1000	1.185,00
761000390	HE115212BL	90	100	6	119,00	714 x 707 x 1000	1.289,00
761000391	HE115213BL	90	100	6	124,00	714 x 707 x 1000	1.295,00
761000392	HE115214BL	90	100	7	124,50	714 x 707 x 1000	1.389,00
761000393	HE115215BL	90	100	8	135,00	714 x 707 x 1000	1.485,00
761000394	HE115216BL	90	100	9	141,50	714 x 707 x 1000	1.585,00
761000395	HE115217BL	90	100	9	143,50	714 x 707 x 1000	1.589,00
761000396	HE115218BL	90	100	11	152,50	714 x 707 x 1000	1.775,00
761000397	HE115219BL	90	100	12	157,00	714 x 707 x 1000	1.869,00
761000398	HE115221BL	100	100	6	128,50	714 x 707 x 1000	1.495,00
761000399	HE115222BL	100	100	6	130,00	714 x 707 x 1000	1.505,00
761000400	HE115223BL	100	100	7	137,50	714 x 707 x 1000	1.635,00
761000401	HE115224BL	100	100	8	148,00	714 x 707 x 1000	1.775,00
761000402	HE115225BL	100	100	9	157,50	714 x 707 x 1000	1.915,00
761000403	HE115226BL	100	100	9	158,50	714 x 707 x 1000	1.925,00
761000404	HE115227BL	100	100	9	161,50	714 x 707 x 1000	1.935,00
761000405	HE115228BL	100	100	12	173,50	714 x 707 x 1000	2.325,00
761000406	HE115229BL	100	100	12	181,00	714 x 707 x 1000	2.335,00
761000407	HE115231BL	100	200	6	143,00	714 x 707 x 1000	1.405,00
761000408	HE115232BL	100	200	6	155,00	714 x 707 x 1000	1.565,00
761000409	HE115233BL	100	200	6	172,00	714 x 707 x 1000	1.569,00
761000410	HE115234BL	100	200	7	167,00	714 x 707 x 1000	1.715,00
761000411	HE115235BL	100	200	8	181,00	714 x 707 x 1000	1.875,00
761000412	HE115236BL	100	200	9	193,00	714 x 707 x 1000	2.025,00
761000413	HE115237BL	100	200	9	193,00	714 x 707 x 1000	2.029,00
761000414	HE115238BL	100	200	11	217,00	714 x 707 x 1000	2.325,00
761000415	HE115239BL	100	200	12	229,00	714 x 707 x 1000	2.465,00
761000745	HE122211BL	90	100	5	84,50	714 x 600 x 1000	1.059,00
761000746	HE122212BL	90	100	6	91,00	714 x 600 x 1000	1.155,00
761000747	HE122213BL	90	100	6	91,00	714 x 600 x 1000	1.165,00
761000748	HE122214BL	90	100	7	97,00	714 x 600 x 1000	1.245,00
761000749	HE122215BL	90	100	8	103,00	714 x 600 x 1000	1.345,00
761000750	HE122216BL	90	100	9	109,00	714 x 600 x 1000	1.415,00
761000751	HE122217BL	90	100	9	109,00	714 x 600 x 1000	1.405,00
761000752	HE122218BL	90	100	11	121,00	714 x 600 x 1000	1.589,00
761000753	HE122219BL	90	100	12	127,00	714 x 600 x 1000	1.685,00

5 laden



HE115201 - HE115211
HE115231 - HE122211

6 laden



HE115202 - HE115212
HE115212 - HE115232
HE122212

6 laden



HE115203 - HE115213
HE115222 - HE115233
HE122213

7 laden



HE115204 - HE115214
HE115223 - HE115234
HE122214

8 laden



HE115224

8 laden



HE115205 - HE115215
HE115235 - HE122215

9 laden



HE115206 - HE115216
HE115226 - HE115236
HE122216

9 laden



HE115225

9 laden



HE115207 - HE115217
HE115227 - HE115237
HE122217

11 laden



HE115208 - HE115218
HE115238 - HE122218

12 laden



HE115209 - HE115219
HE115229 - HE115239
HE122219

12 laden



HE115228



**OOK IN ANDERE
KLEUREN BESCHIKBAAR**
■ ORG NR MET EXTENSIE GR
■ ORG NR MET EXTENSIE RE

Assortiment onderverdelingen vanaf p. 489

EQUIPMENT



Ladenkasten in zeer stabiele en zware uitvoering, geschikt voor intensief en industrieel gebruik. Constructie in plaatstaal 10/10mm (kast) en 15/10mm (laden)..

- breedte 714mm, en hoogte 1000mm
- centrale vergrendeling met een cilinderslot (+2 sleutels)
- zeer hoogwaardige lagergeleidingen
- 1-lade uittrekbeveiliging voorkomt omkantelen
- verschillende compartimenten en lade-indelingen mogelijk
- Diepte 707mm of 600mm mogelijk
- Afwerking: rode poederlak coating in lichte hamerslag uitvoering

Verskillende mogelijke laden:

- Laden 100% uittrekbaar met een draagvermogen van 50kg
- Laden 90% uittrekbaar met een draagvermogen van 100kg
- Laden 100% uittrekbaar met een draagvermogen van 100kg
- Laden 100% uittrekbaar met een draagvermogen van 200kg



Order nr.	Orig. nr.	Uittrekbaar	Capaciteit lades	Aantal laden	Gewicht	Afmetingen (l x b x h)	Prijs
		%	kg				
761020380	HE115201RE	100	50	6	94,00	714 x 707 x 1000	1.205,00
761020381	HE115202RE	100	50	6	98,00	714 x 707 x 1000	1.325,00
761020382	HE115203RE	100	50	6	100,00	714 x 707 x 1000	1.325,00
761020383	HE115204RE	100	50	7	101,50	714 x 707 x 1000	1.425,00
761020384	HE115205RE	100	50	8	107,00	714 x 707 x 1000	1.539,00
761020385	HE115206RE	100	50	9	111,00	714 x 707 x 1000	1.655,00
761020386	HE115207RE	100	50	9	112,00	714 x 707 x 1000	1.655,00
761020387	HE115208RE	100	50	11	118,00	714 x 707 x 1000	1.885,00
761020388	HE115209RE	100	50	12	121,00	714 x 707 x 1000	2.005,00
761003594	HE115211RE	90	100	6	111,50	714 x 707 x 1000	1.185,00
761003595	HE115212RE	90	100	6	119,00	714 x 707 x 1000	1.289,00
761003596	HE115213RE	90	100	6	124,00	714 x 707 x 1000	1.295,00
761003597	HE115214RE	90	100	7	124,50	714 x 707 x 1000	1.389,00
761003598	HE115215RE	90	100	8	135,00	714 x 707 x 1000	1.485,00
761003599	HE115216RE	90	100	9	141,50	714 x 707 x 1000	1.585,00
761003600	HE115217RE	90	100	9	143,50	714 x 707 x 1000	1.589,00
761003601	HE115218RE	90	100	11	152,50	714 x 707 x 1000	1.775,00
761003602	HE115219RE	90	100	12	157,00	714 x 707 x 1000	1.869,00
761020398	HE115221RE	100	100	6	128,50	714 x 707 x 1000	1.495,00
761020399	HE115222RE	100	100	6	130,00	714 x 707 x 1000	1.505,00
761020400	HE115223RE	100	100	7	137,50	714 x 707 x 1000	1.635,00
761020401	HE115224RE	100	100	8	148,00	714 x 707 x 1000	1.775,00
761020402	HE115225RE	100	100	9	157,50	714 x 707 x 1000	1.915,00
761020403	HE115226RE	100	100	9	158,50	714 x 707 x 1000	1.925,00
761020404	HE115227RE	100	100	9	161,50	714 x 707 x 1000	1.935,00
761020405	HE115228RE	100	100	12	173,50	714 x 707 x 1000	2.325,00
761020406	HE115229RE	100	100	12	181,00	714 x 707 x 1000	2.335,00
761020407	HE115231RE	100	200	6	143,00	714 x 707 x 1000	1.405,00
761020408	HE115232RE	100	200	6	155,00	714 x 707 x 1000	1.565,00
761020409	HE115233RE	100	200	6	172,00	714 x 707 x 1000	1.569,00
761020410	HE115234RE	100	200	7	167,00	714 x 707 x 1000	1.715,00
761020411	HE115235RE	100	200	8	181,00	714 x 707 x 1000	1.875,00
761020412	HE115236RE	100	200	9	193,00	714 x 707 x 1000	2.025,00
761020413	HE115237RE	100	200	9	193,00	714 x 707 x 1000	2.029,00
761020414	HE115238RE	100	200	11	217,00	714 x 707 x 1000	2.325,00
761020415	HE115239RE	100	200	12	229,00	714 x 707 x 1000	2.465,00
761020745	HE122211RE	90	100	5	84,50	714 x 600 x 1000	1.059,00
761020746	HE122212RE	90	100	6	91,00	714 x 600 x 1000	1.155,00
761020747	HE122213RE	90	100	6	91,00	714 x 600 x 1000	1.165,00
761020748	HE122214RE	90	100	7	97,00	714 x 600 x 1000	1.245,00
761020749	HE122215RE	90	100	8	103,00	714 x 600 x 1000	1.345,00
761020750	HE122216RE	90	100	9	109,00	714 x 600 x 1000	1.415,00
761020751	HE122217RE	90	100	9	109,00	714 x 600 x 1000	1.405,00
761020752	HE122218RE	90	100	11	121,00	714 x 600 x 1000	1.589,00
761020753	HE122219RE	90	100	12	127,00	714 x 600 x 1000	1.685,00



Ladenkasten in zeer stabiele en zware uitvoering, geschikt voor intensief en industrieel gebruik. Constructie in plaatstaal 10/10mm (kast) en 15/10mm (laden)..

- breedte 714mm, en hoogte 1000mm
- centrale vergrendeling met een cilinderslot (+2 sleutels)
- zeer hoogwaardige lagergeleidingen
- 1-lade uittrekbeveiliging voorkomt omkantelen
- verschillende compartimenten en lade-indelingen mogelijk
- Diepte 707mm of 600mm mogelijk
- Afwerking: grijze poederlak coating in lichte hamerslag uitvoering

Verskillende mogelijke laden:

- Laden 100% uittrekbaar met een draagvermogen van 50kg
- Laden 90% uittrekbaar met een draagvermogen van 100kg
- Laden 100% uittrekbaar met een draagvermogen van 100kg
- Laden 100% uittrekbaar met een draagvermogen van 200kg



Order nr.	Orig. nr.	Uittrekbaar %	Capaciteit lades kg	Aantal laden	Gewicht kg	Afmetingen (l x b x h) mm	Prijs €
761010380	HE115201GR	100	50	6	94,00	714 x 707 x 1000	1.205,00
761010381	HE115202GR	100	50	6	98,00	714 x 707 x 1000	1.325,00
761010382	HE115203GR	100	50	6	100,00	714 x 707 x 1000	1.325,00
761010383	HE115204GR	100	50	7	101,50	714 x 707 x 1000	1.425,00
761010384	HE115205GR	100	50	8	107,00	714 x 707 x 1000	1.539,00
761010385	HE115206GR	100	50	9	111,00	714 x 707 x 1000	1.655,00
761010386	HE115207GR	100	50	9	112,00	714 x 707 x 1000	1.655,00
761010387	HE115208GR	100	50	11	118,00	714 x 707 x 1000	1.885,00
761010388	HE115209GR	100	50	12	121,00	714 x 707 x 1000	2.005,00
761010407	HE115231GR	100	200	6	143,00	714 x 707 x 1000	1.405,00
761010408	HE115232GR	100	200	6	155,00	714 x 707 x 1000	1.565,00
761010409	HE115233GR	100	200	6	172,00	714 x 707 x 1000	1.569,00
761010410	HE115234GR	100	200	7	167,00	714 x 707 x 1000	1.715,00
761010411	HE115235GR	100	200	8	181,00	714 x 707 x 1000	1.875,00
761010412	HE115236GR	100	200	9	193,00	714 x 707 x 1000	2.025,00
761010413	HE115237GR	100	200	9	193,00	714 x 707 x 1000	2.029,00
761010414	HE115238GR	100	200	11	217,00	714 x 707 x 1000	2.325,00
761010415	HE115239GR	100	200	12	229,00	714 x 707 x 1000	2.465,00
761010398	HE115221GR	100	100	6	128,50	714 x 707 x 1000	1.495,00
761010399	HE115222GR	100	100	6	130,00	714 x 707 x 1000	1.505,00
761010400	HE115223GR	100	100	7	137,50	714 x 707 x 1000	1.635,00
761010401	HE115224GR	100	100	8	148,00	714 x 707 x 1000	1.775,00
761010402	HE115225GR	100	100	9	157,50	714 x 707 x 1000	1.915,00
761010403	HE115226GR	100	100	9	158,50	714 x 707 x 1000	1.925,00
761010404	HE115227GR	100	100	9	161,50	714 x 707 x 1000	1.935,00
761010405	HE115228GR	100	100	12	173,50	714 x 707 x 1000	2.325,00
761010406	HE115229GR	100	100	12	181,00	714 x 707 x 1000	2.335,00
761021968	HE115211GR	90	100	6	111,50	714 x 707 x 1000	1.185,00
761021969	HE115212GR	90	100	6	119,00	714 x 707 x 1000	1.289,00
761021970	HE115213GR	90	100	6	124,00	714 x 707 x 1000	1.295,00
761021971	HE115214GR	90	100	7	124,50	714 x 707 x 1000	1.389,00
761021972	HE115215GR	90	100	8	135,00	714 x 707 x 1000	1.485,00
761003572	HE115216GR	90	100	9	141,50	714 x 707 x 1000	1.585,00
761003573	HE115217GR	90	100	9	143,50	714 x 707 x 1000	1.589,00
761003574	HE115218GR	90	100	11	152,50	714 x 707 x 1000	1.775,00
761003575	HE115219GR	90	100	12	157,00	714 x 707 x 1000	1.869,00
761010745	HE122211GR	90	100	5	84,50	714 x 600 x 1000	1.059,00
761010746	HE122212GR	90	100	6	91,00	714 x 600 x 1000	1.155,00
761010747	HE122213GR	90	100	6	91,00	714 x 600 x 1000	1.165,00
761010748	HE122214GR	90	100	7	97,00	714 x 600 x 1000	1.245,00
761010749	HE122215GR	90	100	8	103,00	714 x 600 x 1000	1.345,00
761010750	HE122216GR	90	100	9	109,00	714 x 600 x 1000	1.415,00
761010751	HE122217GR	90	100	9	109,00	714 x 600 x 1000	1.405,00
761010752	HE122218GR	90	100	11	121,00	714 x 600 x 1000	1.589,00
761010753	HE122219GR	90	100	12	127,00	714 x 600 x 1000	1.685,00

Heco ladenkasten 1400x714mm



Ladenkasten in zeer stabiele en zware uitvoering, geschikt voor intensief en industrieel gebruik. Constructie in plaatstaal 10/10mm (kast) en 15/10mm (laden)..

- breedte 714mm, en hoogte 1400mm
- centrale vergrendeling met een cilinderslot (+2 sleutels)
- zeer hoogwaardige lagergeleidingen
- 1-lade uittrekbeveiliging voorkomt omkantelen
- verschillende compartimenten en lade-indelingen mogelijk
- Diepte 707mm of 600mm mogelijk
- Afwerking: blauwe poederlak coating in lichte hamerslag uitvoering

Verschillende mogelijke laden:

- Laden 100% uittrekbaar met een draagvermogen van 50kg
- Laden 90% uittrekbaar met een draagvermogen van 100kg
- Laden 100% uittrekbaar met een draagvermogen van 100kg
- Laden 100% uittrekbaar met een draagvermogen van 200kg

Order nr.	Orig. nr.	Uittrekbaar %	Capaciteit lades kg	Aantal lades	Gewicht kg	Afmetingen (l x b x h) mm	Prijs €
761000423	HE115401BL	100	50	7	120,00	714 x 707 x 1400	1.555,00
761000424	HE115402BL	100	50	7	120,50	714 x 707 x 1400	1.555,00
761000425	HE115403BL	100	50	8	124,00	714 x 707 x 1400	1.669,00
761000426	HE115404BL	100	50	8	123,50	714 x 707 x 1400	1.675,00
761000427	HE115405BL	100	50	10	131,50	714 x 707 x 1400	1.905,00
761000428	HE115406BL	100	50	10	132,50	714 x 707 x 1400	1.905,00
761000429	HE115407BL	100	50	11	134,50	714 x 707 x 1400	2.019,00
761000430	HE115408BL	100	50	12	139,50	714 x 707 x 1400	2.145,00
761000431	HE115409BL	100	50	13	147,00	714 x 707 x 1400	2.255,00
761000432	HE115411BL	90	100	7	144,50	714 x 707 x 1400	1.535,00
761000433	HE115412BL	90	100	7	146,00	714 x 707 x 1400	1.535,00
761000434	HE115413BL	90	100	8	152,00	714 x 707 x 1400	1.629,00
761000435	HE115414BL	90	100	8	151,00	714 x 707 x 1400	1.629,00
761000436	HE115415BL	90	100	10	164,00	714 x 707 x 1400	1.835,00
761000437	HE115416BL	90	100	10	167,00	714 x 707 x 1400	1.845,00
761000438	HE115417BL	90	100	11	169,00	714 x 707 x 1400	1.925,00
761000439	HE115418BL	90	100	12	178,00	714 x 707 x 1400	2.045,00
761000440	HE115419BL	90	100	13	192,00	714 x 707 x 1400	2.165,00
761000441	HE115421BL	100	100	8	166,00	714 x 707 x 1400	1.935,00
761000442	HE115422BL	100	100	8	165,00	714 x 707 x 1400	1.935,00
761000443	HE115423BL	100	100	10	184,00	714 x 707 x 1400	2.209,00
761000444	HE115424BL	100	100	10	185,00	714 x 707 x 1400	2.225,00
761000445	HE115425BL	100	100	11	192,50	714 x 707 x 1400	2.349,00
761000446	HE115426BL	100	100	11	189,50	714 x 707 x 1400	2.345,00
761000447	HE115427BL	100	100	12	202,00	714 x 707 x 1400	2.475,00
761000448	HE115428BL	100	100	12	195,00	714 x 707 x 1400	2.499,00
761000449	HE115429BL	100	100	13	218,50	714 x 707 x 1400	2.655,00
761000450	HE115431BL	100	200	7	189,00	714 x 707 x 1400	1.865,00
761000451	HE115432BL	100	200	7	185,50	714 x 707 x 1400	1.865,00
761000452	HE115433BL	100	200	8	201,00	714 x 707 x 1400	2.019,00
761000453	HE115434BL	100	200	8	200,00	714 x 707 x 1400	2.019,00
761000454	HE115435BL	100	200	10	225,50	714 x 707 x 1400	2.325,00
761000455	HE115436BL	100	200	10	226,00	714 x 707 x 1400	2.329,00
761000456	HE115437BL	100	200	11	236,50	714 x 707 x 1400	2.465,00
761000457	HE115438BL	100	200	12	250,50	714 x 707 x 1400	2.635,00
761000458	HE115439BL	100	200	13	264,00	714 x 707 x 1400	2.799,00
761000757	HE122411BL	90	100	7	114,00	714 x 600 x 1400	1.385,00
761000758	HE122412BL	90	100	7	114,00	714 x 600 x 1400	1.385,00
761000759	HE122413BL	90	100	8	120,00	714 x 600 x 1400	1.455,00
761000760	HE122414BL	90	100	8	121,00	714 x 600 x 1400	1.455,00
761000761	HE122415BL	90	100	10	132,00	714 x 600 x 1400	1.639,00
761000762	HE122416BL	90	100	10	126,00	714 x 600 x 1400	1.639,00
761000763	HE122417BL	90	100	11	138,00	714 x 600 x 1400	1.725,00
761000764	HE122418BL	90	100	12	118,50	714 x 600 x 1400	1.825,00
761000765	HE122419BL	90	100	13	150,00	714 x 600 x 1400	1.909,00

7 laden



HE115401 - HE115411
HE115431 - HE122411

7 laden



HE115402 - HE115412
HE115432 - HE122412

8 laden

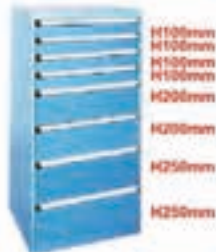

HE115403 - HE115413
HE115421 - HE115433
HE122413

8 laden

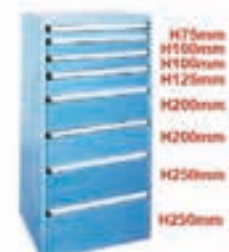

HE115404 - HE115414
HE115422 - HE115434
HE122414

10 laden



HE115405 - HE115415
HE115435 - HE122415

10 laden



HE115406 - HE115416
HE115424 - HE115436
HE122416

10 laden



HE115423

11 laden



HE115425

11 laden



HE115407 - HE115417
HE115426 - HE115437
HE122417

12 laden



HE115408 - HE115418
HE115428 - HE115438
HE122418

12 laden



HE115427

13 laden



HE115409 - HE115419
HE115429 - HE115439
HE122419

**OOK IN ANDERE
KLEUREN BESCHIKBAAR**

ORG NI MET EXTENSIE GR

ORG NI MET EXTENSIE RE

EQUIPMENT



Assortiment onderverdelingen vanaf p. 489



Ladenkasten in zeer stabiele en zware uitvoering, geschikt voor intensief en industrieel gebruik. Constructie in plaatstaal 10/10mm (kast) en 15/10mm (laden)..

- breedte 714mm, en hoogte 1400mm
- centrale vergrendeling met een cilinderslot (+2 sleutels)
- zeer hoogwaardige lagergeleidingen
- 1-lade uittrekbeveiliging voorkomt omkantelen
- verschillende compartimenten en lade-indelingen mogelijk
- Diepte 707mm of 600mm mogelijk
- Afwerking: rode poederlak coating in lichte hamerslag uitvoering

Verskillende mogelijke laden:

- Laden 100% uittrekbaar met een draagvermogen van 50kg
- Laden 90% uittrekbaar met een draagvermogen van 100kg
- Laden 100% uittrekbaar met een draagvermogen van 100kg
- Laden 100% uittrekbaar met een draagvermogen van 200kg



Order nr.	Orig. nr.	Uittrekbaar %	Capaciteit lades kg	Aantal laden	Gewicht kg	Afmetingen (l x b x h) mm	Prijs €
761020423	HE115401RE	100	50	7	120,00	714 x 707 x 1400	1.555,00
761020424	HE115402RE	100	50	7	120,50	714 x 707 x 1400	1.555,00
761020425	HE115403RE	100	50	8	124,00	714 x 707 x 1400	1.669,00
761020426	HE115404RE	100	50	8	123,50	714 x 707 x 1400	1.675,00
761020427	HE115405RE	100	50	10	131,50	714 x 707 x 1400	1.905,00
761020428	HE115406RE	100	50	10	132,50	714 x 707 x 1400	1.905,00
761020429	HE115407RE	100	50	11	134,50	714 x 707 x 1400	2.019,00
761020430	HE115408RE	100	50	12	139,50	714 x 707 x 1400	2.145,00
761020431	HE115409RE	100	50	13	147,00	714 x 707 x 1400	2.255,00
761003603	HE115411RE	90	100	7	144,50	714 x 707 x 1400	1.535,00
761003604	HE115412RE	90	100	7	146,00	714 x 707 x 1400	1.535,00
761003605	HE115413RE	90	100	8	152,00	714 x 707 x 1400	1.629,00
761003606	HE115414RE	90	100	8	151,00	714 x 707 x 1400	1.629,00
761003607	HE115415RE	90	100	10	164,00	714 x 707 x 1400	1.835,00
761003608	HE115416RE	90	100	10	167,00	714 x 707 x 1400	1.845,00
761003609	HE115417RE	90	100	11	169,00	714 x 707 x 1400	1.925,00
761003610	HE115418RE	90	100	12	178,00	714 x 707 x 1400	2.045,00
761003611	HE115419RE	90	100	13	192,00	714 x 707 x 1400	2.165,00
761020441	HE115421RE	100	100	8	166,00	714 x 707 x 1400	1.935,00
761020442	HE115422RE	100	100	8	165,00	714 x 707 x 1400	1.935,00
761020443	HE115423RE	100	100	10	184,00	714 x 707 x 1400	2.209,00
761020444	HE115424RE	100	100	10	185,00	714 x 707 x 1400	2.225,00
761020445	HE115425RE	100	100	11	192,50	714 x 707 x 1400	2.349,00
761020446	HE115426RE	100	100	11	189,50	714 x 707 x 1400	2.345,00
761020447	HE115427RE	100	100	12	202,00	714 x 707 x 1400	2.475,00
761020448	HE115428RE	100	100	12	195,00	714 x 707 x 1400	2.499,00
761020449	HE115429RE	100	100	13	218,50	714 x 707 x 1400	2.655,00
761020450	HE115431RE	100	200	7	189,00	714 x 707 x 1400	1.865,00
761020451	HE115432RE	100	200	7	185,50	714 x 707 x 1400	1.865,00
761020452	HE115433RE	100	200	8	201,00	714 x 707 x 1400	2.019,00
761020453	HE115434RE	100	200	8	200,00	714 x 707 x 1400	2.019,00
761020454	HE115435RE	100	200	10	225,50	714 x 707 x 1400	2.325,00
761020455	HE115436RE	100	200	10	226,00	714 x 707 x 1400	2.329,00
761020456	HE115437RE	100	200	11	236,50	714 x 707 x 1400	2.465,00
761020457	HE115438RE	100	200	12	250,50	714 x 707 x 1400	2.635,00
761020458	HE115439RE	100	200	13	264,00	714 x 707 x 1400	2.799,00
761020757	HE122411RE	90	100	7	114,00	714 x 600 x 1400	1.385,00
761020758	HE122412RE	90	100	7	114,00	714 x 600 x 1400	1.385,00
761020759	HE122413RE	90	100	8	120,00	714 x 600 x 1400	1.455,00
761020760	HE122414RE	90	100	8	121,00	714 x 600 x 1400	1.455,00
761020761	HE122415RE	90	100	10	132,00	714 x 600 x 1400	1.639,00
761020762	HE122416RE	90	100	10	126,00	714 x 600 x 1400	1.639,00
761020763	HE122417RE	90	100	11	138,00	714 x 600 x 1400	1.725,00
761020764	HE122418RE	90	100	12	118,50	714 x 600 x 1400	1.825,00
761020765	HE122419RE	90	100	13	150,00	714 x 600 x 1400	1.909,00



Ladenkasten in zeer stabiele en zware uitvoering, geschikt voor intensief en industrieel gebruik. Constructie in plaatstaal 10/10mm (kast) en 15/10mm (laden)..

- breedte 714mm, en hoogte 1400mm
- centrale vergrendeling met een cilinderslot (+2 sleutels)
- zeer hoogwaardige lagergeleidingen
- 1-lade uittrekbeveiliging voorkomt omkantelen
- verschillende compartimenten en lade-indelingen mogelijk
- Diepte 707mm of 600mm mogelijk
- Afwerking: grijze poederlak coating in lichte hamerslag uitvoering

Verskillende mogelijke laden:

- Laden 100% uittrekbaar met een draagvermogen van 50kg
- Laden 90% uittrekbaar met een draagvermogen van 100kg
- Laden 100% uittrekbaar met een draagvermogen van 100kg
- Laden 100% uittrekbaar met een draagvermogen van 200kg



Order nr.	Orig. nr.	Uittrekbaar %	Capaciteit lades kg	Aantal laden	Gewicht kg	Afmetingen (l x b x h) mm	Prijs
							€
761010423	HE115401GR	100	50	7	120,00	714 x 707 x 1400	1.555,00
761010424	HE115402GR	100	50	7	120,50	714 x 707 x 1400	1.555,00
761010425	HE115403GR	100	50	8	124,00	714 x 707 x 1400	1.669,00
761010426	HE115404GR	100	50	8	123,50	714 x 707 x 1400	1.675,00
761010427	HE115405GR	100	50	10	131,50	714 x 707 x 1400	1.905,00
761010428	HE115406GR	100	50	10	132,50	714 x 707 x 1400	1.905,00
761010429	HE115407GR	100	50	11	134,50	714 x 707 x 1400	2.019,00
761010430	HE115408GR	100	50	12	139,50	714 x 707 x 1400	2.145,00
761010431	HE115409GR	100	50	13	147,00	714 x 707 x 1400	2.255,00
761010450	HE115431GR	100	200	7	189,00	714 x 707 x 1400	1.865,00
761010451	HE115432GR	100	200	7	185,50	714 x 707 x 1400	1.865,00
761010452	HE115433GR	100	200	8	201,00	714 x 707 x 1400	2.019,00
761010453	HE115434GR	100	200	8	200,00	714 x 707 x 1400	2.019,00
761010454	HE115435GR	100	200	10	225,50	714 x 707 x 1400	2.325,00
761010455	HE115436GR	100	200	10	226,00	714 x 707 x 1400	2.329,00
761010456	HE115437GR	100	200	11	236,50	714 x 707 x 1400	2.465,00
761010457	HE115438GR	100	200	12	250,50	714 x 707 x 1400	2.635,00
761010458	HE115439GR	100	200	13	264,00	714 x 707 x 1400	2.799,00
761010441	HE115421GR	100	100	8	166,00	714 x 707 x 1400	1.935,00
761010442	HE115422GR	100	100	8	165,00	714 x 707 x 1400	1.935,00
761010443	HE115423GR	100	100	10	184,00	714 x 707 x 1400	2.209,00
761010444	HE115424GR	100	100	10	185,00	714 x 707 x 1400	2.225,00
761010445	HE115425GR	100	100	11	192,50	714 x 707 x 1400	2.349,00
761010446	HE115426GR	100	100	11	189,50	714 x 707 x 1400	2.345,00
761010447	HE115427GR	100	100	12	202,00	714 x 707 x 1400	2.475,00
761010448	HE115428GR	100	100	12	195,00	714 x 707 x 1400	2.499,00
761010449	HE115429GR	100	100	13	218,50	714 x 707 x 1400	2.655,00
761003576	HE115411GR	90	100	7	144,50	714 x 707 x 1400	1.535,00
761003577	HE115412GR	90	100	7	146,00	714 x 707 x 1400	1.535,00
761003578	HE115413GR	90	100	8	152,00	714 x 707 x 1400	1.629,00
761003579	HE115414GR	90	100	8	151,00	714 x 707 x 1400	1.629,00
761003580	HE115415GR	90	100	10	164,00	714 x 707 x 1400	1.835,00
761003581	HE115416GR	90	100	10	167,00	714 x 707 x 1400	1.845,00
761003582	HE115417GR	90	100	11	169,00	714 x 707 x 1400	1.925,00
761003583	HE115418GR	90	100	12	178,00	714 x 707 x 1400	2.045,00
761003584	HE115419GR	90	100	13	192,00	714 x 707 x 1400	2.165,00
761010757	HE122411GR	90	100	7	114,00	714 x 600 x 1400	1.385,00
761010758	HE122412GR	90	100	7	114,00	714 x 600 x 1400	1.385,00
761010759	HE122413GR	90	100	8	120,00	714 x 600 x 1400	1.455,00
761010760	HE122414GR	90	100	8	121,00	714 x 600 x 1400	1.455,00
761010761	HE122415GR	90	100	10	132,00	714 x 600 x 1400	1.385,00
761010762	HE122416GR	90	100	10	126,00	714 x 600 x 1400	1.639,00
761010763	HE122417GR	90	100	11	138,00	714 x 600 x 1400	1.725,00
761010764	HE122418GR	90	100	12	118,50	714 x 600 x 1400	1.825,00
761010765	HE122419GR	90	100	13	150,00	714 x 600 x 1400	1.909,00

EQUIPMENT

Heco ladenkasten 700x1020mm



Ladenkasten in zeer stabiele en zware uitvoering, geschikt voor intensief en industrieel gebruik. Constructie in plaatstaal 10/10mm (kast) en 15/10mm (laden)..

- breedte 1020mm, en hoogte 700mm
- centrale vergrendeling met een cilinderslot (+2 sleutels)
- zeer hoogwaardige lagergeleidingen
- 1-lade uittrekbeveiliging voorkomt omkantelen
- verschillende compartimenten en lade-indelingen mogelijk
- Diepte 707mm of 600mm mogelijk
- Afwerking: blauwe poederlak coating in lichte hamerslag uitvoering



Verskillende mogelijke laden:

- Laden 100% uittrekbaar met een draagvermogen van 50kg
- Laden 90% uittrekbaar met een draagvermogen van 100kg
- Laden 100% uittrekbaar met een draagvermogen van 100kg
- Laden 100% uittrekbaar met een draagvermogen van 200kg

Order nr.	Orig. nr.	Uittrekbaar %	Capaciteit lades kg	Aantal laden	Gewicht kg	Afmetingen (l x b x h) mm	Prijs €
761000563	HE119111BL	90	100	3	107,50	1020 x 707 x 700	1.075,00
761000564	HE119112BL	90	100	4	120,00	1020 x 707 x 700	1.205,00
761000565	HE119113BL	90	100	4	118,00	1020 x 707 x 700	1.215,00
761000566	HE119114BL	90	100	4	117,50	1020 x 707 x 700	1.205,00
761000567	HE119115BL	90	100	4	119,50	1020 x 707 x 700	1.215,00
761000568	HE119116BL	90	100	5	129,00	1020 x 707 x 700	1.339,00
761000569	HE119117BL	90	100	5	130,50	1020 x 707 x 700	1.345,00
761000570	HE119118BL	90	100	6	144,00	1020 x 707 x 700	1.455,00
761000571	HE119119BL	90	100	8	158,00	1020 x 707 x 700	1.705,00
761000572	HE119121BL	100	100	3	115,50	1020 x 707 x 700	1.195,00
761000573	HE119122BL	100	100	4	129,00	1020 x 707 x 700	1.375,00
761000574	HE119123BL	100	100	4	130,00	1020 x 707 x 700	1.385,00
761000575	HE119124BL	100	100	4	129,50	1020 x 707 x 700	1.375,00
761000576	HE119125BL	100	100	5	144,00	1020 x 707 x 700	1.535,00
761000581	HE119126BL	100	100	5	143,50	1020 x 707 x 700	1.535,00
761000582	HE119127BL	100	100	5	144,00	1020 x 707 x 700	1.545,00
761000583	HE119128BL	100	100	6	159,00	1020 x 707 x 700	1.725,00
761000584	HE119129BL	100	100	8	186,00	1020 x 707 x 700	2.065,00
761000585	HE119131BL	100	200	3	131,00	1020 x 707 x 700	1.295,00
761000586	HE119132BL	100	200	4	150,00	1020 x 707 x 700	1.485,00
761000587	HE119133BL	100	200	4	152,00	1020 x 707 x 700	1.495,00
761000588	HE119134BL	100	200	4	149,50	1020 x 707 x 700	1.479,00
761000589	HE119135BL	100	200	4	150,50	1020 x 707 x 700	1.485,00
761000590	HE119136BL	100	200	5	169,50	1020 x 707 x 700	1.695,00
761000591	HE119137BL	100	200	5	169,50	1020 x 707 x 700	1.705,00
761000592	HE119138BL	100	200	6	189,00	1020 x 707 x 700	1.915,00
761000593	HE119139BL	100	200	8	226,00	1020 x 707 x 700	2.315,00
761001964	HE123111	90	100	3	87,00	1020 x 600 x 700	955,00
761001965	HE123112	90	100	4	95,00	1020 x 600 x 700	1.065,00
761001966	HE123113	90	100	4	94,00	1020 x 600 x 700	1.079,00
761001967	HE123114	90	100	4	95,00	1020 x 600 x 700	1.079,00
761001968	HE123115	90	100	4	95,00	1020 x 600 x 700	1.069,00
761001969	HE123116	90	100	5	102,00	1020 x 600 x 700	1.195,00
761001970	HE123117	90	100	5	103,00	1020 x 600 x 700	1.189,00
761001971	HE123118	90	100	6	111,00	1020 x 600 x 700	1.295,00
761001972	HE123119	90	100	8	124,00	1020 x 600 x 700	1.545,00

3 laden



H150mm
H200mm
H250mm

HE119111 - HE119121
HE119131 - HE123111

4 laden



H100mm
H100mm
H200mm
H200mm

HE119112 - HE119122
HE119132 - HE123112

4 laden



H150mm
H150mm
H150mm
H150mm

HE119113 - HE119123
HE119133 - HE123113

4 laden



H75mm
H75mm
H200mm
H250mm

HE119114 - HE119134
HE123114

4 laden



H100mm
H100mm
H150mm
H250mm

HE119115 - HE119135
HE123115

4 laden



H50mm
H100mm
H200mm
H250mm

HE119124

5 laden



H75mm
H100mm
H100mm
H125mm
H200mm

HE119117 - HE119127
HE119137 - HE123117

5 laden



H75mm
H75mm
H100mm
H150mm
H200mm

HE119116 - HE119126
HE119136 - HE123116

5 laden



H50mm
H75mm
H75mm
H150mm
H250mm

HE119125

6 laden



H100mm
H100mm
H100mm
H100mm
H100mm
H100mm

HE119118 - HE119128
HE119138 - HE123118

8 laden



H75mm
H75mm
H75mm
H75mm
H75mm
H75mm
H75mm
H75mm

HE119119 - HE119129
HE119139 - HE123119



Assortiment onderverdelingen vanaf p. 489



Ladenkasten in zeer stabiele en zware uitvoering, geschikt voor intensief en industrieel gebruik. Constructie in plaatstaal 10/10mm (kast) en 15/10mm (laden)..

- breedte 1020mm, en hoogte 700mm
- centrale vergrendeling met een cilinderslot (+2 sleutels)
- zeer hoogwaardige lagergeleidingen
- 1-lade uittrekbeveiliging voorkomt omkantelen
- verschillende compartimenten en lade-indelingen mogelijk
- Diepte 707mm of 600mm mogelijk
- Afwerking: rode poederlak coating in lichte hamerslag uitvoering

Verschillende mogelijke laden:

- Laden 100% uittrekbaar met een draagvermogen van 50kg
- Laden 90% uittrekbaar met een draagvermogen van 100kg
- Laden 100% uittrekbaar met een draagvermogen van 100kg
- Laden 100% uittrekbaar met een draagvermogen van 200kg



Order nr.	Orig. nr.	Uittrekbaar		Aantal laden	Gewicht kg	Afmetingen (l x b x h) mm	Prijs €
		%	Capaciteit lades kg				
761033631	HE119111RE	90	100	3	107,50	1020 x 707 x 700	1.075,00
761033632	HE119112RE	90	100	4	120,00	1020 x 707 x 700	1.205,00
761033633	HE119113RE	90	100	4	118,00	1020 x 707 x 700	1.215,00
761033634	HE119114RE	90	100	4	117,50	1020 x 707 x 700	1.205,00
761033635	HE119115RE	90	100	4	119,50	1020 x 707 x 700	1.215,00
761033636	HE119116RE	90	100	5	129,00	1020 x 707 x 700	1.339,00
761033637	HE119117RE	90	100	5	130,50	1020 x 707 x 700	1.345,00
761033638	HE119118RE	90	100	6	144,00	1020 x 707 x 700	1.455,00
761033639	HE119119RE	90	100	8	158,00	1020 x 707 x 700	1.705,00
761020572	HE119121RE	100	100	3	115,50	1020 x 707 x 700	1.195,00
761020573	HE119122RE	100	100	4	129,00	1020 x 707 x 700	1.375,00
761020574	HE119123RE	100	100	4	130,00	1020 x 707 x 700	1.385,00
761020575	HE119124RE	100	100	4	129,50	1020 x 707 x 700	1.375,00
761020576	HE119125RE	100	100	5	144,00	1020 x 707 x 700	1.535,00
761020581	HE119126RE	100	100	5	143,50	1020 x 707 x 700	1.535,00
761020582	HE119127RE	100	100	5	144,00	1020 x 707 x 700	1.545,00
761020583	HE119128RE	100	100	6	159,00	1020 x 707 x 700	1.725,00
761020584	HE119129RE	100	100	8	186,00	1020 x 707 x 700	2.065,00
761020585	HE119131RE	100	200	3	131,00	1020 x 707 x 700	1.295,00
761020586	HE119132RE	100	200	4	150,00	1020 x 707 x 700	1.485,00
761020587	HE119133RE	100	200	4	152,00	1020 x 707 x 700	1.495,00
761020588	HE119134RE	100	200	4	149,50	1020 x 707 x 700	1.479,00
761020589	HE119135RE	100	200	4	150,50	1020 x 707 x 700	1.485,00
761020590	HE119136RE	100	200	5	169,50	1020 x 707 x 700	1.695,00
761020591	HE119137RE	100	200	5	169,50	1020 x 707 x 700	1.705,00
761020592	HE119138RE	100	200	6	189,00	1020 x 707 x 700	1.915,00
761020593	HE119139RE	100	200	8	226,00	1020 x 707 x 700	2.315,00
761033566	HE123111RE	90	100	3	105,50	1020 x 600 x 1000	1.315,00
761033567	HE123112RE	90	100	4	113,00	1020 x 600 x 1000	1.425,00
761033568	HE123113RE	90	100	4	112,00	1020 x 600 x 1000	1.435,00
761033569	HE123114RE	90	100	4	120,50	1020 x 600 x 1000	1.545,00
761033570	HE123115RE	90	100	4	128,00	1020 x 600 x 1000	1.665,00
761033571	HE123116RE	90	100	5	136,00	1020 x 600 x 1000	1.775,00
761033572	HE123117RE	90	100	5	137,50	1020 x 600 x 1000	1.745,00
761033573	HE123118RE	90	100	6	150,50	1020 x 600 x 1000	2.025,00
761033574	HE123119RE	90	100	8	157,00	1020 x 600 x 1000	2.159,00



Ladenkasten in zeer stabiele en zware uitvoering, geschikt voor intensief en industrieel gebruik. Constructie in plaatstaal 10/10mm (kast) en 15/10mm (laden)..

- breedte 1020mm, en hoogte 700mm
- centrale vergrendeling met een cilinderslot (+2 sleutels)
- zeer hoogwaardige lagergeleidingen
- 1-lade uittrekbeveiliging voorkomt omkantelen
- verschillende compartimenten en lade-indelingen mogelijk
- Diepte 707mm of 600mm mogelijk
- Afwerking: grijze poederlak coating in lichte hamerslag uitvoering

Verschillende mogelijke laden:

- Laden 100% uittrekbaar met een draagvermogen van 50kg
- Laden 90% uittrekbaar met een draagvermogen van 100kg
- Laden 100% uittrekbaar met een draagvermogen van 100kg
- Laden 100% uittrekbaar met een draagvermogen van 200kg



Order nr.	Orig. nr.	Uittrekbaar %	Capaciteit lades kg	Aantal laden	Gewicht kg	Afmetingen (l x b x h) mm	Prijs
							€
761010585	HE119131GR	100	200	3	131,00	1020 x 707 x 700	1.295,00
761010586	HE119132GR	100	200	4	150,00	1020 x 707 x 700	1.485,00
761010587	HE119133GR	100	200	4	152,00	1020 x 707 x 700	1.495,00
761010588	HE119134GR	100	200	4	149,50	1020 x 707 x 700	1.479,00
761010589	HE119135GR	100	200	4	150,50	1020 x 707 x 700	1.485,00
761010590	HE119136GR	100	200	5	169,50	1020 x 707 x 700	1.695,00
761010591	HE119137GR	100	200	5	169,50	1020 x 707 x 700	1.705,00
761010592	HE119138GR	100	200	6	189,00	1020 x 707 x 700	1.915,00
761010593	HE119139GR	100	200	8	226,00	1020 x 707 x 700	2.315,00
761033593	HE123111GR	90	100	3	105,50	1020 x 600 x 1000	1.315,00
761033594	HE123112GR	90	100	4	113,00	1020 x 600 x 1000	1.425,00
761033595	HE123113GR	90	100	4	112,00	1020 x 600 x 1000	1.435,00
761033596	HE123114GR	90	100	4	120,50	1020 x 600 x 1000	1.545,00
761033597	HE123115GR	90	100	4	128,00	1020 x 600 x 1000	1.665,00
761033598	HE123116GR	90	100	5	136,00	1020 x 600 x 1000	1.775,00
761033599	HE123117GR	90	100	5	137,50	1020 x 600 x 1000	1.745,00
761033600	HE123118GR	90	100	6	150,50	1020 x 600 x 1000	2.025,00
761033601	HE123119GR	90	100	8	157,00	1020 x 600 x 1000	2.159,00
761010572	HE119121GR	100	100	3	115,50	1020 x 707 x 700	1.195,00
761010573	HE119122GR	100	100	4	129,00	1020 x 707 x 700	1.375,00
761010574	HE119123GR	100	100	4	130,00	1020 x 707 x 700	1.385,00
761010575	HE119124GR	100	100	4	129,50	1020 x 707 x 700	1.375,00
761010576	HE119125GR	100	100	5	144,00	1020 x 707 x 700	1.535,00
761010581	HE119126GR	100	100	5	143,50	1020 x 707 x 700	1.535,00
761010582	HE119127GR	100	100	5	144,00	1020 x 707 x 700	1.545,00
761010583	HE119128GR	100	100	6	159,00	1020 x 707 x 700	1.725,00
761010584	HE119129GR	100	100	8	186,00	1020 x 707 x 700	2.065,00
761033658	HE119111GR	90	100	3	107,50	1020 x 707 x 700	1.075,00
761033659	HE119112GR	90	100	4	120,00	1020 x 707 x 700	1.205,00
761033660	HE119113GR	90	100	4	118,00	1020 x 707 x 700	1.215,00
761033661	HE119114GR	90	100	4	117,50	1020 x 707 x 700	1.205,00
761033662	HE119115GR	90	100	4	119,50	1020 x 707 x 700	1.215,00
761033663	HE119116GR	90	100	5	129,00	1020 x 707 x 700	1.339,00
761033664	HE119117GR	90	100	5	130,50	1020 x 707 x 700	1.345,00
761033665	HE119118GR	90	100	6	144,00	1020 x 707 x 700	1.455,00
761033666	HE119119GR	90	100	8	158,00	1020 x 707 x 700	1.705,00



Heco ladenkasten 1000x1020mm



Ladenkasten in zeer stabiele en zware uitvoering, geschikt voor intensief en industrieel gebruik. Constructie in plaatstaal 10/10mm (kast) en 15/10mm (laden)..

- breedte 1020mm, en hoogte 1000mm
- centrale vergrendeling met een cilinderslot (+2 sleutels)
- zeer hoogwaardige lagergeleidingen
- 1-lade uittrekbeveiliging voorkomt omkantelen
- verschillende compartimenten en lade-indelingen mogelijk
- Diepte 707mm of 600mm mogelijk
- Afwerking: blauwe poederlak coating in lichte hamerslag uitvoering

Verskillende mogelijke laden:

- Laden 100% uittrekbaar met een draagvermogen van 50kg
- Laden 90% uittrekbaar met een draagvermogen van 100kg
- Laden 100% uittrekbaar met een draagvermogen van 100kg
- Laden 100% uittrekbaar met een draagvermogen van 200kg



Order nr.	Orig. nr.	Uittrekbaar %	Capaciteit lades kg	Aantal laden	Gewicht kg	Afmetingen (l x b x h) mm	Prijs €
761000604	HE119211BL	90	100	5	149,00	1020 x 707 x 1000	1.479,00
761000605	HE119212BL	90	100	6	159,00	1020 x 707 x 1000	1.619,00
761000606	HE119213BL	90	100	6	158,00	1020 x 707 x 1000	1.625,00
761000607	HE119214BL	90	100	7	169,00	1020 x 707 x 1000	1.745,00
761000608	HE119215BL	90	100	8	181,00	1020 x 707 x 1000	1.889,00
761000609	HE119216BL	90	100	9	192,50	1020 x 707 x 1000	2.015,00
761000610	HE119217BL	90	100	9	197,00	1020 x 707 x 1000	2.015,00
761000611	HE119218BL	90	100	11	211,00	1020 x 707 x 1000	2.259,00
761000612	HE119219BL	90	100	12	218,00	1020 x 707 x 1000	2.385,00
761000613	HE119221BL	100	100	6	173,50	1020 x 707 x 1000	1.869,00
761000614	HE119222BL	100	100	6	176,00	1020 x 707 x 1000	1.879,00
761000615	HE119223BL	100	100	7	190,00	1020 x 707 x 1000	2.045,00
761000616	HE119224BL	100	100	8	203,00	1020 x 707 x 1000	2.219,00
761000617	HE119225BL	100	100	9	218,00	1020 x 707 x 1000	2.405,00
761000618	HE119226BL	100	100	9	219,00	1020 x 707 x 1000	2.415,00
761000619	HE119227BL	100	100	9	219,50	1020 x 707 x 1000	2.415,00
761000620	HE119228BL	100	100	12	260,00	1020 x 707 x 1000	2.925,00
761000621	HE119229BL	100	100	12	260,00	1020 x 707 x 1000	2.925,00
761000622	HE119231BL	100	200	5	186,00	1020 x 707 x 1000	1.845,00
761000623	HE119232BL	100	200	6	205,00	1020 x 707 x 1000	2.065,00
761000624	HE119233BL	100	200	6	209,00	1020 x 707 x 1000	2.065,00
761000625	HE119234BL	100	200	7	225,00	1020 x 707 x 1000	2.265,00
761000626	HE119235BL	100	200	8	246,00	1020 x 707 x 1000	2.489,00
761000627	HE119236BL	100	200	9	264,50	1020 x 707 x 1000	2.695,00
761000628	HE119237BL	100	200	9	264,50	1020 x 707 x 1000	2.695,00
761000629	HE119238BL	100	200	11	301,50	1020 x 707 x 1000	3.095,00
761000630	HE119239BL	100	200	12	320,00	1020 x 707 x 1000	2.399,00
761000784	HE123211	90	100	5	105,50	1020 x 600 x 1000	1.315,00
761000785	HE123212	90	100	6	113,00	1020 x 600 x 1000	1.425,00
761000786	HE123213	90	100	6	112,00	1020 x 600 x 1000	1.435,00
761000787	HE123214	90	100	7	120,50	1020 x 600 x 1000	1.545,00
761000788	HE123215	90	100	8	128,00	1020 x 600 x 1000	1.665,00
761000789	HE123216	90	100	9	136,00	1020 x 600 x 1000	1.775,00
761000790	HE123217	90	100	9	137,50	1020 x 600 x 1000	1.745,00
761000791	HE123218	90	100	11	150,50	1020 x 600 x 1000	2.025,00
761000792	HE123219	90	100	12	157,00	1020 x 600 x 1000	2.159,00

5 laden



H100mm
H200mm
H200mm
H200mm
H200mm

HE119211 - HE119231
HE123211

6 laden



H75mm
H100mm
H125mm
H150mm
H200mm
H250mm

HE119212 - HE119221
HE119232 - HE123212

6 laden



H150mm
H150mm
H150mm
H150mm
H150mm
H150mm

HE119213 - HE119222
HE119233 - HE123213

7 laden



H75mm
H75mm
H75mm
H100mm
H125mm
H200mm
H250mm

HE119214 - HE119223
HE119234 - HE123214

8 laden



H75mm
H75mm
H100mm
H100mm
H125mm
H125mm
H150mm
H150mm

HE119215 - HE119235
HE123215

8 laden



H50mm
H50mm
H75mm
H100mm
H100mm
H125mm
H200mm
H200mm

HE119224

9 laden



H100mm
H100mm
H100mm
H100mm
H100mm
H100mm
H100mm
H100mm
H100mm

HE119217 - HE119227
HE119237 - HE123217

9 laden



H75mm
H75mm
H75mm
H100mm
H100mm
H100mm
H100mm
H125mm
H150mm

HE119216 - HE119226
HE119236 - HE123216

9 laden



H50mm
H50mm
H75mm
H75mm
H100mm
H100mm
H125mm
H125mm
H200mm

HE119225

11 laden



H75mm
H75mm
H75mm
H75mm
H75mm
H75mm
H75mm
H75mm
H75mm
H100mm
H100mm

HE119218 - HE119238
HE123218

12 laden



H75mm
H75mm
H75mm
H75mm
H75mm
H75mm
H75mm
H75mm
H75mm
H75mm
H75mm
H75mm

HE119219 - HE119229
HE119239 - HE123219

12 laden



H50mm
H50mm
H50mm
H75mm
H75mm
H75mm
H75mm
H75mm
H75mm
H100mm
H100mm
H100mm

HE119228



Assortiment onderverdelingen vanaf p. 489



Ladenkasten in zeer stabiele en zware uitvoering, geschikt voor intensief en industrieel gebruik. Constructie in plaatstaal 10/10mm (kast) en 15/10mm (laden)..

- breedte 1020mm, en hoogte 1000mm
- centrale vergrendeling met een cilinderslot (+2 sleutels)
- zeer hoogwaardige lagergeleidingen
- 1-lade uittrekbeveiliging voorkomt omkantelen
- verschillende compartimenten en lade-indelingen mogelijk
- Diepte 707mm of 600mm mogelijk
- Afwerking: rode poederlak coating in lichte hamerslag uitvoering

Verskillende mogelijke laden:

- Laden 100% uittrekbaar met een draagvermogen van 50kg
- Laden 90% uittrekbaar met een draagvermogen van 100kg
- Laden 100% uittrekbaar met een draagvermogen van 100kg
- Laden 100% uittrekbaar met een draagvermogen van 200kg



Order nr.	Orig. nr.	Uittrekbaar		Capaciteit lades	Aantal laden	Gewicht	Afmetingen (l x b x h)	Prijs
		%	kg					
761033640	HE119211RE	90	100	100	5	149,00	1020 x 707 x 1000	1.479,00
761033641	HE119212RE	90	100	100	6	159,00	1020 x 707 x 1000	1.619,00
761033642	HE119213RE	90	100	100	6	158,00	1020 x 707 x 1000	1.625,00
761033643	HE119214RE	90	100	100	7	169,00	1020 x 707 x 1000	1.745,00
761033644	HE119215RE	90	100	100	8	181,00	1020 x 707 x 1000	1.889,00
761033645	HE119216RE	90	100	100	9	192,50	1020 x 707 x 1000	2.015,00
761033646	HE119217RE	90	100	100	9	197,00	1020 x 707 x 1000	2.015,00
761033647	HE119218RE	90	100	100	11	211,00	1020 x 707 x 1000	2.259,00
761033648	HE119219RE	90	100	100	12	218,00	1020 x 707 x 1000	2.385,00
761020613	HE119221RE	100	100	100	6	173,50	1020 x 707 x 1000	1.869,00
761020614	HE119222RE	100	100	100	6	176,00	1020 x 707 x 1000	1.879,00
761020615	HE119223RE	100	100	100	7	190,00	1020 x 707 x 1000	2.045,00
761020616	HE119224RE	100	100	100	8	203,00	1020 x 707 x 1000	2.219,00
761020617	HE119225RE	100	100	100	9	218,00	1020 x 707 x 1000	2.405,00
761020618	HE119226RE	100	100	100	9	219,00	1020 x 707 x 1000	2.415,00
761020619	HE119227RE	100	100	100	9	219,50	1020 x 707 x 1000	2.415,00
761020620	HE119228RE	100	100	100	12	260,00	1020 x 707 x 1000	2.925,00
761020621	HE119229RE	100	100	100	12	260,00	1020 x 707 x 1000	2.925,00
761020622	HE119231RE	100	200	200	5	186,00	1020 x 707 x 1000	1.845,00
761020623	HE119232RE	100	200	200	6	205,00	1020 x 707 x 1000	2.065,00
761020624	HE119233RE	100	200	200	6	209,00	1020 x 707 x 1000	2.065,00
761020625	HE119234RE	100	200	200	7	225,00	1020 x 707 x 1000	2.265,00
761020626	HE119235RE	100	200	200	8	246,00	1020 x 707 x 1000	2.489,00
761020627	HE119236RE	100	200	200	9	264,50	1020 x 707 x 1000	2.695,00
761020628	HE119237RE	100	200	200	9	264,50	1020 x 707 x 1000	2.695,00
761020629	HE119238RE	100	200	200	11	301,50	1020 x 707 x 1000	3.095,00
761020630	HE119239RE	100	200	200	12	320,00	1020 x 707 x 1000	2.399,00
761033575	HE123211RE	90	100	100	5	142,50	1020 x 600 x 1400	1.785,00
761033576	HE123212RE	90	100	100	6	142,00	1020 x 600 x 1400	1.795,00
761033577	HE123213RE	90	100	100	6	151,00	1020 x 600 x 1400	1.905,00
761033578	HE123214RE	90	100	100	7	150,50	1020 x 600 x 1400	1.915,00
761033579	HE123215RE	90	100	100	8	165,00	1020 x 600 x 1400	2.159,00
761033580	HE123216RE	90	100	100	9	155,00	1020 x 600 x 1400	2.149,00
761033581	HE123217RE	90	100	100	9	172,00	1020 x 600 x 1400	2.289,00
761033582	HE123218RE	90	100	100	11	179,50	1020 x 600 x 1400	2.409,00
761033583	HE123219RE	90	100	100	12	177,50	1020 x 600 x 1400	2.465,00



Ladenkasten in zeer stabiele en zware uitvoering, geschikt voor intensief en industrieel gebruik. Constructie in plaatstaal 10/10mm (kast) en 15/10mm (laden)..

- breedte 1020mm, en hoogte 1000mm
- centrale vergrendeling met een cilinderslot (+2 sleutels)
- zeer hoogwaardige lagergeleidingen
- 1-lade uittrekbeveiliging voorkomt omkantelen
- verschillende compartimenten en lade-indelingen mogelijk
- Diepte 707mm of 600mm mogelijk
- Afwerking: grijze poederlak coating in lichte hamerslag uitvoering

Verschillende mogelijke laden:

- Laden 100% uittrekbaar met een draagvermogen van 50kg
- Laden 90% uittrekbaar met een draagvermogen van 100kg
- Laden 100% uittrekbaar met een draagvermogen van 100kg
- Laden 100% uittrekbaar met een draagvermogen van 200kg

INFO
p.477

Order nr.	Orig. nr.	Uittrekbaar	Capaciteit lades	Aantal laden	Gewicht	Afmetingen (l x b x h)	Prijs
		%	kg		kg		€
761010622	HE119231GR	100	200	5	186,00	1020 x 707 x 1000	1.845,00
761010623	HE119232GR	100	200	6	205,00	1020 x 707 x 1000	2.065,00
761010624	HE119233GR	100	200	6	209,00	1020 x 707 x 1000	2.065,00
761010625	HE119234GR	100	200	7	225,00	1020 x 707 x 1000	2.265,00
761010626	HE119235GR	100	200	8	246,00	1020 x 707 x 1000	2.489,00
761010627	HE119236GR	100	200	9	264,50	1020 x 707 x 1000	2.695,00
761010628	HE119237GR	100	200	9	264,50	1020 x 707 x 1000	2.695,00
761010629	HE119238GR	100	200	11	301,50	1020 x 707 x 1000	3.095,00
761010630	HE119239GR	100	200	12	320,00	1020 x 707 x 1000	2.399,00
761033602	HE123211GR	90	100	5	142,50	1020 x 600 x 1400	1.785,00
761033603	HE123212GR	90	100	6	142,00	1020 x 600 x 1400	1.795,00
761033604	HE123213GR	90	100	6	151,00	1020 x 600 x 1400	1.905,00
761033605	HE123214GR	90	100	7	150,50	1020 x 600 x 1400	1.915,00
761033606	HE123215GR	90	100	8	165,00	1020 x 600 x 1400	2.159,00
761033607	HE123216GR	90	100	9	155,00	1020 x 600 x 1400	2.149,00
761033608	HE123217GR	90	100	9	172,00	1020 x 600 x 1400	2.289,00
761033609	HE123218GR	90	100	11	179,50	1020 x 600 x 1400	2.409,00
761033610	HE123219GR	90	100	12	177,50	1020 x 600 x 1400	2.465,00
761010613	HE119221GR	100	100	6	173,50	1020 x 707 x 1000	1.869,00
761010614	HE119222GR	100	100	6	176,00	1020 x 707 x 1000	1.879,00
761010615	HE119223GR	100	100	7	190,00	1020 x 707 x 1000	2.045,00
761010616	HE119224GR	100	100	8	203,00	1020 x 707 x 1000	2.219,00
761010617	HE119225GR	100	100	9	218,00	1020 x 707 x 1000	2.405,00
761010618	HE119226GR	100	100	9	219,00	1020 x 707 x 1000	2.415,00
761010619	HE119227GR	100	100	9	219,50	1020 x 707 x 1000	2.415,00
761010620	HE119228GR	100	100	12	260,00	1020 x 707 x 1000	2.925,00
761010621	HE119229GR	100	100	12	260,00	1020 x 707 x 1000	2.925,00
761033667	HE119211GR	90	100	5	149,00	1020 x 707 x 1000	1.479,00
761033668	HE119212GR	90	100	6	159,00	1020 x 707 x 1000	1.619,00
761033669	HE119213GR	90	100	6	158,00	1020 x 707 x 1000	1.625,00
761033670	HE119214GR	90	100	7	169,00	1020 x 707 x 1000	1.745,00
761033671	HE119215GR	90	100	8	181,00	1020 x 707 x 1000	1.889,00
761033672	HE119216GR	90	100	9	192,50	1020 x 707 x 1000	2.015,00
761033673	HE119217GR	90	100	9	197,00	1020 x 707 x 1000	2.015,00
761033674	HE119218GR	90	100	11	211,00	1020 x 707 x 1000	2.259,00
761033675	HE119219GR	90	100	12	218,00	1020 x 707 x 1000	2.385,00

Heco ladenkasten 1400x1020mm



Ladenkasten in zeer stabiele en zware uitvoering, geschikt voor intensief en industrieel gebruik. Constructie in plaatstaal 10/10mm (kast) en 15/10mm (laden)..

- breedte 1020mm, en hoogte 1400mm
- centrale vergrendeling met een cilinderslot (+2 sleutels)
- zeer hoogwaardige lagergeleidingen
- 1-lade uittrekbeveiliging voorkomt omkantelen
- verschillende compartimenten en lade-indelingen mogelijk
- Diepte 707mm of 600mm mogelijk
- Afwerking: blauwe poederlak coating in lichte hamerslag uitvoering

Verskillende mogelijke laden:

- Laden 100% uittrekbaar met een draagvermogen van 50kg
- Laden 90% uittrekbaar met een draagvermogen van 100kg
- Laden 100% uittrekbaar met een draagvermogen van 100kg
- Laden 100% uittrekbaar met een draagvermogen van 200kg



Order nr.	Orig. nr.	Uittrekbaar	Capaciteit lades	Aantal laden	Gewicht	Afmetingen (l x b x h)	Prijs €
		%	kg		kg	mm	
761000636	HE119411BL	90	100	7	193,00	1020 x 707 x 1400	1.905,00
761000637	HE119412BL	90	100	7	192,00	1020 x 707 x 1400	1.915,00
761000638	HE119413BL	90	100	8	205,00	1020 x 707 x 1400	2.045,00
761000639	HE119414BL	90	100	8	203,50	1020 x 707 x 1400	2.045,00
761000640	HE119415BL	90	100	10	223,50	1020 x 707 x 1400	2.309,00
761000641	HE119416BL	90	100	10	225,50	1020 x 707 x 1400	2.315,00
761000642	HE119417BL	90	100	11	231,00	1020 x 707 x 1400	2.425,00
761000643	HE119418BL	90	100	12	243,00	1020 x 707 x 1400	2.575,00
761000644	HE119419BL	90	100	13	265,00	1020 x 707 x 1400	2.705,00
761000645	HE119421BL	100	100	7	230,00	1020 x 707 x 1400	2.375,00
761000646	HE119422BL	100	100	7	230,00	1020 x 707 x 1400	2.375,00
761000647	HE119423BL	100	100	8	251,50	1020 x 707 x 1400	2.725,00
761000648	HE119424BL	100	100	8	254,00	1020 x 707 x 1400	2.745,00
761000649	HE119425BL	100	100	10	266,00	1020 x 707 x 1400	2.909,00
761000650	HE119426BL	100	100	10	272,00	1020 x 707 x 1400	2.895,00
761000651	HE119427BL	100	100	11	280,50	1020 x 707 x 1400	3.085,00
761000652	HE119428BL	100	100	12	282,50	1020 x 707 x 1400	3.099,00
761000653	HE119429BL	100	100	13	297,50	1020 x 707 x 1400	3.289,00
761000654	HE119431BL	100	200	7	245,50	1020 x 707 x 1400	2.415,00
761000655	HE119432BL	100	200	7	246,50	1020 x 707 x 1400	2.419,00
761000656	HE119433BL	100	200	8	265,00	1020 x 707 x 1400	2.629,00
761000657	HE119434BL	100	200	8	265,00	1020 x 707 x 1400	2.629,00
761000658	HE119435BL	100	200	10	303,50	1020 x 707 x 1400	3.055,00
761000659	HE119436BL	100	200	10	304,50	1020 x 707 x 1400	3.059,00
761000660	HE119437BL	100	200	11	321,50	1020 x 707 x 1400	3.245,00
761000661	HE119438BL	100	200	12	342,50	1020 x 707 x 1400	3.475,00
761000662	HE119439BL	100	200	13	362,50	1020 x 707 x 1400	3.695,00
761000796	HE123411	90	100	7	142,50	1020 x 600 x 1400	1.785,00
761000797	HE123412	90	100	7	142,00	1020 x 600 x 1400	1.795,00
761000798	HE123413	90	100	8	151,00	1020 x 600 x 1400	1.905,00
761000799	HE123414	90	100	8	150,50	1020 x 600 x 1400	1.915,00
761000800	HE123415	90	100	10	165,00	1020 x 600 x 1400	2.159,00
761000801	HE123416	90	100	10	155,00	1020 x 600 x 1400	2.149,00
761000802	HE123417	90	100	11	172,00	1020 x 600 x 1400	2.289,00
761000803	HE123418	90	100	12	179,50	1020 x 600 x 1400	2.409,00
761000804	HE123419	90	100	13	177,50	1020 x 600 x 1400	2.465,00

7 laden



H100mm
H200mm
H200mm
H200mm
H200mm
H200mm
H200mm

HE119411 - HE119431
HE123411

7 laden



H150mm
H150mm
H200mm
H200mm
H200mm
H200mm
H200mm

HE119412 - HE119432
HE123412

8 laden



H100mm
H100mm
H100mm
H100mm
H200mm
H200mm
H250mm
H250mm

HE119413 - HE119433
HE119421 - HE123413

8 laden



H75mm
H100mm
H100mm
H125mm
H200mm
H200mm
H250mm
H250mm

HE119414 - HE119434
HE119422 - HE123414

10 laden



H75mm
H75mm
H75mm
H75mm
H100mm
H125mm
H125mm
H200mm
H200mm
H250mm

HE119415 - HE119435

10 laden



H75mm
H75mm
H100mm
H100mm
H100mm
H125mm
H125mm
H150mm
H200mm
H250mm

HE119424 - HE119416
HE119436 - HE123416

10 laden



H50mm
H50mm
H75mm
H100mm
H125mm
H150mm
H150mm
H200mm
H200mm
H200mm

HE119423

11 laden



H75mm
H75mm
H75mm
H75mm
H75mm
H75mm
H75mm
H75mm
H200mm
H250mm
H250mm

HE119417 - HE119426
HE119437 - HE123415
HE123417

11 laden



H50mm
H50mm
H75mm
H75mm
H75mm
H125mm
H150mm
H150mm
H150mm
H200mm
H200mm

HE119425

12 laden



H50mm
H50mm
H50mm
H50mm
H75mm
H75mm
H100mm
H100mm
H150mm
H150mm
H200mm

HE119427

12 laden



H75mm
H75mm
H75mm
H75mm
H75mm
H75mm
H125mm
H125mm
H150mm
H250mm

HE119418 - HE119428
HE119438 - HE123418

13 laden



H100mm
H100mm
H100mm
H100mm
H100mm
H100mm
H100mm
H100mm
H100mm
H100mm
H100mm
H100mm

HE119419 - HE119429
HE119439 - HE123419



EQUIPMENT



Ladenkasten in zeer stabiele en zware uitvoering, geschikt voor intensief en industrieel gebruik. Constructie in plaatstaal 10/10mm (kast) en 15/10mm (laden)..

- breedte 1020mm, en hoogte 1400mm
- centrale vergrendeling met een cilinderslot (+2 sleutels)
- zeer hoogwaardige lagergeleidingen
- 1-lade uittrekbeveiliging voorkomt omkantelen
- verschillende compartimenten en lade-indelingen mogelijk
- Diepte 707mm of 600mm mogelijk
- Afwerking: rode poederlak coating in lichte hamerslag uitvoering



Verskillende mogelijke laden:

- Laden 100% uittrekbaar met een draagvermogen van 50kg
- Laden 90% uittrekbaar met een draagvermogen van 100kg
- Laden 100% uittrekbaar met een draagvermogen van 100kg
- Laden 100% uittrekbaar met een draagvermogen van 200kg

Order nr.	Orig. nr.	Uittrekbaar %	Capaciteit lades kg	Aantal laden	Gewicht kg	Afmetingen (l x b x h) mm	Prijs €
761033649	HE119411RE	90	100	7	193,00	1020 x 707 x 1400	1.905,00
761033650	HE119412RE	90	100	7	192,00	1020 x 707 x 1400	1.915,00
761033651	HE119413RE	90	100	8	205,00	1020 x 707 x 1400	2.045,00
761033652	HE119414RE	90	100	8	203,50	1020 x 707 x 1400	2.045,00
761033653	HE119415RE	90	100	10	223,50	1020 x 707 x 1400	2.309,00
761033654	HE119416RE	90	100	10	225,50	1020 x 707 x 1400	2.315,00
761033655	HE119417RE	90	100	11	231,00	1020 x 707 x 1400	2.425,00
761033656	HE119418RE	90	100	12	243,00	1020 x 707 x 1400	2.575,00
761033657	HE119419RE	90	100	13	265,00	1020 x 707 x 1400	2.705,00
761020645	HE119421RE	100	100	7	230,00	1020 x 707 x 1400	2.375,00
761020646	HE119422RE	100	100	7	230,00	1020 x 707 x 1400	2.375,00
761020647	HE119423RE	100	100	8	251,50	1020 x 707 x 1400	2.725,00
761020648	HE119424RE	100	100	8	254,00	1020 x 707 x 1400	2.745,00
761020649	HE119425RE	100	100	10	266,00	1020 x 707 x 1400	2.909,00
761020650	HE119426RE	100	100	10	272,00	1020 x 707 x 1400	2.895,00
761020651	HE119427RE	100	100	11	280,50	1020 x 707 x 1400	3.085,00
761020652	HE119428RE	100	100	12	282,50	1020 x 707 x 1400	3.099,00
761020653	HE119429RE	100	100	13	297,50	1020 x 707 x 1400	3.289,00
761020654	HE119431RE	100	200	7	245,50	1020 x 707 x 1400	2.415,00
761020655	HE119432RE	100	200	7	246,50	1020 x 707 x 1400	2.419,00
761020656	HE119433RE	100	200	8	265,00	1020 x 707 x 1400	2.629,00
761020657	HE119434RE	100	200	8	265,00	1020 x 707 x 1400	2.629,00
761020658	HE119435RE	100	200	10	303,50	1020 x 707 x 1400	3.055,00
761020659	HE119436RE	100	200	10	304,50	1020 x 707 x 1400	3.059,00
761020660	HE119437RE	100	200	11	321,50	1020 x 707 x 1400	3.245,00
761020661	HE119438RE	100	200	12	342,50	1020 x 707 x 1400	3.475,00
761020662	HE119439RE	100	200	13	362,50	1020 x 707 x 1400	3.695,00
761033584	HE123411RE	90	100	7	87,00	1020 x 600 x 700	955,00
761033585	HE123412RE	90	100	7	95,00	1020 x 600 x 700	1.065,00
761033586	HE123413RE	90	100	8	94,00	1020 x 600 x 700	1.079,00
761033587	HE123414RE	90	100	8	95,00	1020 x 600 x 700	1.079,00
761033588	HE123415RE	90	100	10	95,00	1020 x 600 x 700	1.069,00
761033589	HE123416RE	90	100	10	102,00	1020 x 600 x 700	1.195,00
761033590	HE123417RE	90	100	11	103,00	1020 x 600 x 700	1.189,00
761033591	HE123418RE	90	100	12	111,00	1020 x 600 x 700	1.295,00
761033592	HE123419RE	90	100	13	124,00	1020 x 600 x 700	1.545,00



Ladenkasten in zeer stabiele en zware uitvoering, geschikt voor intensief en industrieel gebruik. Constructie in plaatstaal 10/10mm (kast) en 15/10mm (laden)..

- breedte 1020mm, en hoogte 1400mm
- centrale vergrendeling met een cilinderslot (+2 sleutels)
- zeer hoogwaardige lagergeleidingen
- 1-lade uittrekbeveiliging voorkomt omkantelen
- verschillende compartimenten en lade-indelingen mogelijk
- Diepte 707mm of 600mm mogelijk
- Afwerking: grijze poederlak coating in lichte hamerslag uitvoering

Verschillende mogelijke laden:

- Laden 100% uittrekbaar met een draagvermogen van 50kg
- Laden 90% uittrekbaar met een draagvermogen van 100kg
- Laden 100% uittrekbaar met een draagvermogen van 100kg
- Laden 100% uittrekbaar met een draagvermogen van 200kg



Order nr.	Orig. nr.	Uittrekbaar %	Capaciteit lades kg	Aantal laden	Gewicht kg	Afmetingen (l x b x h)		Prijs €
						mm		
761010654	HE119431GR	100	200	7	245,50	1020 x 707 x 1400	2.415,00	
761010655	HE119432GR	100	200	7	246,50	1020 x 707 x 1400	2.419,00	
761010656	HE119433GR	100	200	8	265,00	1020 x 707 x 1400	2.629,00	
761010657	HE119434GR	100	200	8	265,00	1020 x 707 x 1400	2.629,00	
761010658	HE119435GR	100	200	10	303,50	1020 x 707 x 1400	3.055,00	
761010659	HE119436GR	100	200	10	304,50	1020 x 707 x 1400	3.059,00	
761010660	HE119437GR	100	200	11	321,50	1020 x 707 x 1400	3.245,00	
761010661	HE119438GR	100	200	12	342,50	1020 x 707 x 1400	3.475,00	
761010662	HE119439GR	100	200	13	362,50	1020 x 707 x 1400	3.695,00	
761033611	HE123411GR	90	100	7	87,00	1020 x 600 x 700	955,00	
761033612	HE123412GR	90	100	7	95,00	1020 x 600 x 700	1.065,00	
761033613	HE123413GR	90	100	8	94,00	1020 x 600 x 700	1.079,00	
761033614	HE123414GR	90	100	8	95,00	1020 x 600 x 700	1.079,00	
761033615	HE123415GR	90	100	10	95,00	1020 x 600 x 700	1.069,00	
761033616	HE123416GR	90	100	10	102,00	1020 x 600 x 700	1.195,00	
761033617	HE123417GR	90	100	11	103,00	1020 x 600 x 700	1.189,00	
761033618	HE123418GR	90	100	12	111,00	1020 x 600 x 700	1.295,00	
761033619	HE123419GR	90	100	13	124,00	1020 x 600 x 700	1.545,00	
761010645	HE119421GR	100	100	7	230,00	1020 x 707 x 1400	2.375,00	
761010646	HE119422GR	100	100	7	230,00	1020 x 707 x 1400	2.375,00	
761010647	HE119423GR	100	100	8	251,50	1020 x 707 x 1400	2.725,00	
761010648	HE119424GR	100	100	8	254,00	1020 x 707 x 1400	2.745,00	
761010649	HE119425GR	100	100	10	266,00	1020 x 707 x 1400	2.909,00	
761010650	HE119426GR	100	100	10	272,00	1020 x 707 x 1400	2.895,00	
761010651	HE119427GR	100	100	11	280,50	1020 x 707 x 1400	3.085,00	
761010652	HE119428GR	100	100	12	282,50	1020 x 707 x 1400	3.099,00	
761010653	HE119429GR	100	100	13	297,50	1020 x 707 x 1400	3.289,00	
761033676	HE119411GR	90	100	7	193,00	1020 x 707 x 1400	1.905,00	
761033677	HE119412GR	90	100	7	192,00	1020 x 707 x 1400	1.915,00	
761033678	HE119413GR	90	100	8	205,00	1020 x 707 x 1400	2.045,00	
761033679	HE119414GR	90	100	8	203,50	1020 x 707 x 1400	2.045,00	
761033680	HE119415GR	90	100	10	223,50	1020 x 707 x 1400	2.309,00	
761033681	HE119416GR	90	100	10	225,50	1020 x 707 x 1400	2.315,00	
761033682	HE119417GR	90	100	11	231,00	1020 x 707 x 1400	2.425,00	
761033683	HE119418GR	90	100	12	243,00	1020 x 707 x 1400	2.575,00	
761033684	HE119419GR	90	100	13	265,00	1020 x 707 x 1400	2.705,00	

Heco ladenkasten



plaatdikte 10/10 mm, Laden 15/10 mm



zeer goede inzicht op de lade inhoud



centrale vergrendeling



anti-omkeer mechanisme

Ladenkasten in zeer stabiele en zware uitvoering, geschikt voor intensief en industrieel gebruik. Constructie in plaatstaal 10/10mm met een poederlak coating in lichte hamerslag uitvoering.

- laden 90% uittrekbaar met een draagvermogen van 100kg
- breedte 515mm, diepte 600mm en 3 hoogtes (700, 1000 en 1400mm)
- centrale vergrendeling met een cilinderslot (+2 sleutels)
- zeer hoogwaardige lagergeleidingen
- 1-lade uittrekbeveiliging voorkomt omkantelen
- verschillende compartimenten en lade-indelingen mogelijk

Order nr.	Orig. nr.	Uittrekbaar %	Capaciteit lades kg	Aantal lades	Gewicht kg	Afmetingen (l x b x h) mm	Prijs €
761000944	HE135111BL	90	100	2	44,00	515 x 600 x 700	555,00
761000945	HE135112BL	90	100	4	54,50	515 x 600 x 700	755,00
761000946	HE135113BL	90	100	4	55,00	515 x 600 x 700	755,00
761000947	HE135114BL	90	100	4	54,00	515 x 600 x 700	749,00
761000948	HE135115BL	90	100	4	54,50	515 x 600 x 700	749,00
761000949	HE135116BL	90	100	5	59,50	515 x 600 x 700	825,00
761000950	HE135117BL	90	100	5	59,50	515 x 600 x 700	825,00
761000951	HE135118BL	90	100	6	65,00	515 x 600 x 700	915,00
761000952	HE135119BL	90	100	8	75,00	515 x 600 x 700	1.095,00
761000964	HE135211BL	90	100	5	71,00	515 x 600 x 1000	969,00
761000965	HE135212BL	90	100	6	77,00	515 x 600 x 1000	1.055,00
761000966	HE135213BL	90	100	6	78,00	515 x 600 x 1000	1.065,00
761000967	HE135214BL	90	100	7	82,00	515 x 600 x 1000	1.145,00
761000968	HE135215BL	90	100	8	88,00	515 x 600 x 1000	1.245,00
761000969	HE135216BL	90	100	9	93,00	515 x 600 x 1000	1.325,00
761000970	HE135217BL	90	100	9	93,00	515 x 600 x 1000	1.325,00
761000971	HE135218BL	90	100	11	103,00	515 x 600 x 1000	1.485,00
761000972	HE135219BL	90	100	12	108,00	515 x 600 x 1000	1.569,00
761001976	HE135411BL	90	100	7	98,00	515 x 600 x 1400	1.285,00
761001977	HE135412BL	90	100	7	98,00	515 x 600 x 1400	1.285,00
761001978	HE135413BL	90	100	8	104,00	515 x 600 x 1400	1.369,00
761001979	HE135414BL	90	100	8	104,00	515 x 600 x 1400	1.369,00
761001980	HE135415BL	90	100	10	114,00	515 x 600 x 1400	1.535,00
761001981	HE135416BL	90	100	10	114,50	515 x 600 x 1400	1.535,00
761001982	HE135417BL	90	100	11	120,00	515 x 600 x 1400	1.615,00
761001983	HE135418BL	90	100	12	125,00	515 x 600 x 1400	1.709,00
761001984	HE135419BL	90	100	12	131,00	515 x 600 x 1400	1.789,00

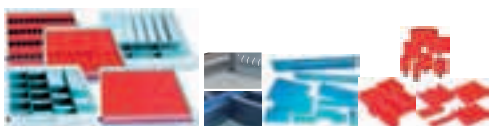
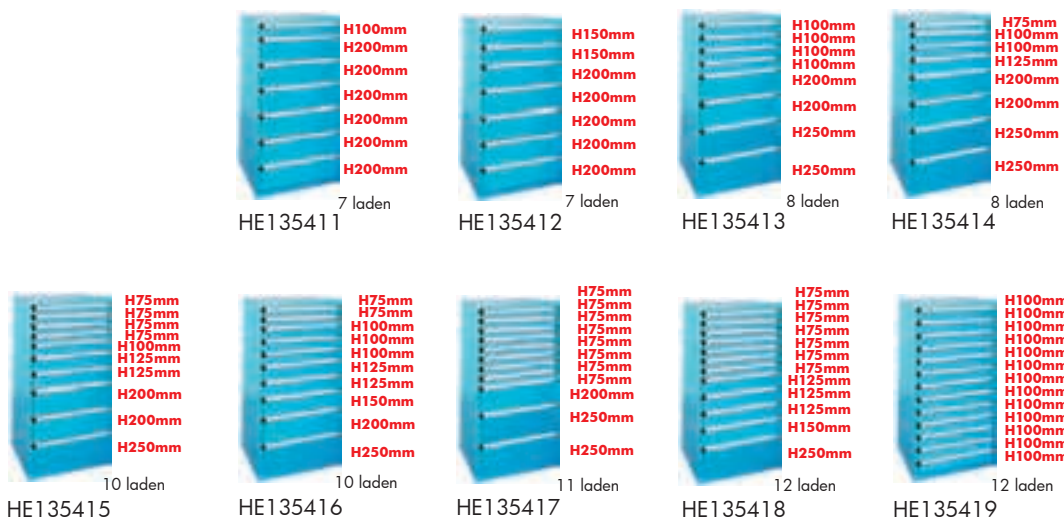

Assortiment onderverdelingen vanaf p. 489

voor up-to-date informatie zie online catalogus op www.vynckier.biz



HE13621

5 laden

- H75mm
- H100mm
- H125mm
- H125mm
- H300mm



HE13622

6 laden

- H75mm
- H75mm
- H100mm
- H125mm
- H150mm
- H200mm



Ladenkasten in zeer stabiele en zware uitvoering, geschikt voor intensief en industrieel gebruik. Constructie in plaatstaal 10/10mm met een poederlak coating in lichte hamerslag uitvoering.

- laden 90% uittrekbaar met een draagvermogen van 100kg
- breedte 555mm, diepte 600mm en hoogte 825mm
- centrale vergrendeling met een cilinderslot (+2 sleutels)
- zeer hoogwaardige lagergeleidingen
- 1-lade uittrekbeveiliging voorkomt omkantelen
- verschillende compartimenten en lade-indelingen mogelijk

Order nr.	Orig. nr.	Gewicht kg	Afmetingen (l x b x h) mm	Prijs €
761001988	HE13621BL	62,00	600 x 515 x 825	885,00
761001989	HE13622BL	67,00	600 x 515 x 825	975,00



HE127



Ladenkasten met deuren in zeer stabiele en zware uitvoering, geschikt voor intensief en industrieel gebruik. Constructie in plaatstaal 10/10mm met een poederlak coating in lichte hamerslag uitvoering.

- laden 100% uittrekbaar met een draagvermogen van 100kg
- breedte 714mm, diepte 707mm en 2 hoogtes (1000 en 1400mm)
- deurhoogte 600mm, 675mm of 900mm
- centrale vergrendeling met een cilinderslot (+2 sleutels)
- zeer hoogwaardige lagergeleidingen
- 1-lade uittrekbeveiliging voorkomt omkantelen
- verschillende compartimenten en lade-indelingen mogelijk

Order nr.	Orig. nr.	Aantal laden	Open ruimte mm	Gewicht kg	Afmetingen (l x b x h) mm	Prijs €
761000879	HE12731BL	3	600	77,50	714 x 730 x 1000	1.059,00
761000886	HE12741BL	4	900	97,50	714 x 730 x 1400	1.415,00
761000893	HE12751BL	5	675	112,00	714 x 730 x 1400	1.179,00
761000900	HE12761BL	6	600	121,00	714 x 730 x 1400	1.745,00
761000901	HE12762BL	6	600	138,00	714 x 730 x 1400	1.919,00
761000894	HE12752BL	5	675	129,00	714 x 730 x 1400	1.355,00
761000887	HE12742BL	4	900	114,50	714 x 730 x 1400	1.589,00
761000880	HE12732BL	3	600	97,50	714 x 730 x 1000	1.235,00
761000902	HE12763BL	6	600	144,50	714 x 730 x 1400	1.895,00
761000895	HE12753BL	5	675	135,50	714 x 730 x 1400	1.335,00
761000888	HE12743BL	4	900	146,00	714 x 730 x 1400	1.755,00
761000881	HE12733BL	3	600	104,00	714 x 730 x 1000	1.215,00
761000903	HE12764BL	6	600	153,00	714 x 730 x 1400	1.985,00
761000896	HE12754BL	5	675	144,00	714 x 730 x 1400	1.399,00
761000889	HE12744BL	4	900	129,50	714 x 730 x 1400	1.655,00
761000882	HE12734BL	3	600	112,50	714 x 730 x 1000	1.305,00
761000904	HE12765BL	6	600	154,50	714 x 730 x 1400	2.175,00
761000897	HE12755BL	5	675	145,50	714 x 730 x 1400	1.589,00
761000890	HE12745BL	4	900	127,50	714 x 730 x 1400	1.845,00
761000883	HE12735BL	3	600	110,50	714 x 730 x 1000	1.449,00
761000905	HE12766BL	6	600	171,00	714 x 730 x 1400	2.405,00
761000898	HE12756BL	5	675	162,00	714 x 730 x 1400	1.819,00
761000891	HE12746BL	4	900	147,50	714 x 730 x 1400	2.075,00
761000884	HE12736BL	3	600	123,50	714 x 730 x 1000	1.705,00

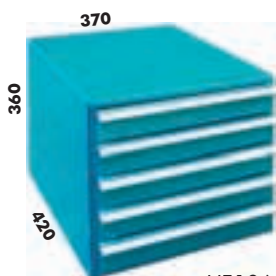

HE10641

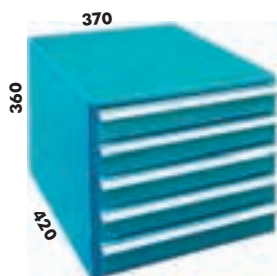
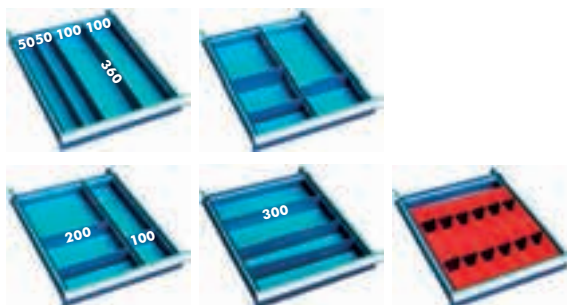

HE10642

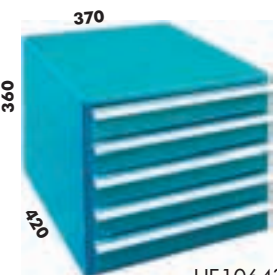
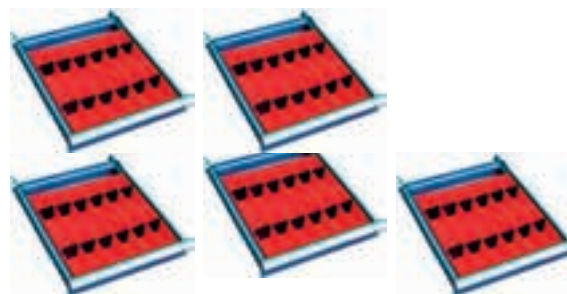

HE10643

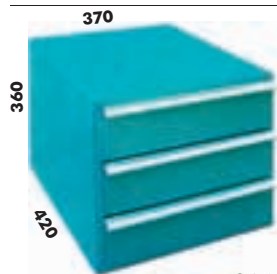
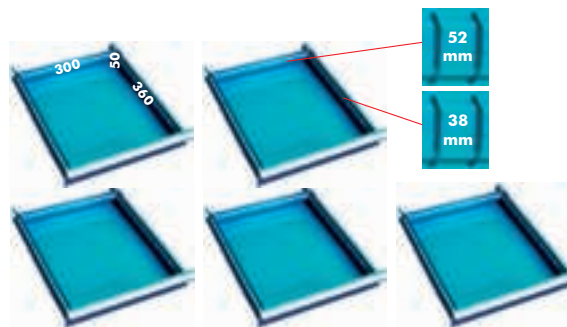

HE10644

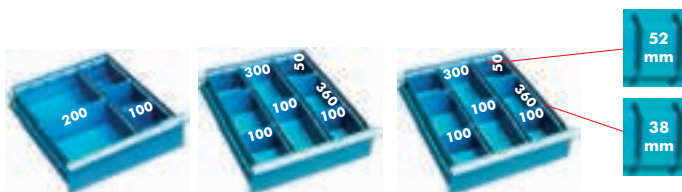

Ladenkasten in zeer stabiele en zware uitvoering geschikt voor intensief en industrieel gebruik. Constructie in plaatstaal 8/10mm met een poederlak coating in lichte hamerslag uitvoering.

- breedte 370mm, hoogte 360mm en diepte 420mm
- zeer hoogwaardige geleidingen
- verschillende compartimenten en lade-indelingen mogelijk

Order nr.	Orig. nr.	Gewicht kg	Afmetingen (l x b x h) mm	Prijs €
761000067	HE10641BL	19,84	370 x 420 x 360	296,00
761000068	HE10642BL	20,56	370 x 420 x 360	311,00
761000069	HE10643BL	17,70	370 x 420 x 360	245,00
761000070	HE10644BL	18,40	370 x 420 x 360	282,00

HECO



Kunststof bakjes voor lades en tussenschotten.

Order nr.	Orig. nr.	Gewicht	Afmetingen (l x b x h)		Prijs
			kg	mm	
761001745	HECPA00	5,00	100 x 50 x 50	1,10	
761001746	HECPA01	5,00	150 x 50 x 47	0,80	
761001748	HECPA02	5,00	100 x 100 x 50	1,20	
761001749	HECPA03	5,00	75 x 75 x 50	2,10	
761001750	HECPA04	5,00	150 x 75 x 50	2,30	
761001751	HECPA05	5,00	150 x 150 x 50	2,50	
761001752	HECPA06	5,00	120 x 60 x 50	1,30	
761001753	HECPA07	5,00	120 x 120 x 50	1,10	
761001762	HECPC03	5,00	75 x 75 x 71	3,00	
761001763	HECPC04	5,00	150 x 75 x 71	3,30	
761001764	HECPC05	5,00	150 x 150 x 71	3,50	

HECO



Freeshouder in kunstof. Hoogte 25mm.

Order nr.	Orig. nr.	Diameter mm	Gewicht kg	Prijs
761001773	HEPFA13	13	5,00	5,60
761001774	HEPFA16	16	5,00	5,60
761001775	HEPFA22	22	5,00	1,10
761001776	HEPFA27	13	5,00	5,70
761001777	HEPFA32	32	5,00	5,70
761001778	HEPFA40	40	5,00	5,70
761001779	HEPFA50	50	5,00	5,80

HECO



Gereedschapshouder 6 onderverdelingen. Tot 20 mm. 150x30x28 of 150x65x28.

Order nr.	761001780	€	8,20
Orig. nr.	HEPHA06		
Gewicht	kg	5,00	
Prijs	€	8,20	

HECO



Gereedschapshouder 8 onderverdelingen. Tot 14 mm. 150x30x28 of 150x65x28.

Order nr.	761001781	€	9,00
Orig. nr.	HEPHA08		
Gewicht	kg	5,00	
Prijs	€	9,00	

HECO



Gereedschapshouder 11 onderverdelingen. Tot 8 mm. 150x30x28 of 150x65x28.

Order nr.	761001782	€	13,50
Orig. nr.	HEPHA11		
Gewicht	kg	5,00	
Prijs	€	13,50	

HECO



Universeel opdeelvak 2-delig.

Order nr.	761001756	€	13,50
Orig. nr.	HECPA10		
Gewicht	kg	5,00	
Prijs	€	13,50	

HECO



Tussenschot voor HECPA10.

Order nr.	761001757	€	2,10
Orig. nr.	HECPA101		
Gewicht	kg	5,00	
Prijs	€	2,10	

HECO



Universeel opdeelvak 3-delig.

Order nr.	761001758 €
Orig. nr.	HECPA11
Gewicht	kg 5,00
Prijs	€ 13,50

HECO



Tussenschot voor HECPA11.

Order nr.	761001759 €
Orig. nr.	HECPA111
Gewicht	kg 5,00
Prijs	€ 1,60

HECO



Universeel opdeelvak 4-delig.

Order nr.	761001760 €
Orig. nr.	HECPA12
Gewicht	kg 5,00
Prijs	€ 13,50

HECO



Tussenschot voor HECPA12.

Order nr.	761001761 €
Orig. nr.	HECPA121
Gewicht	kg 5,00
Prijs	€ 1,30

HECO



HEMPO1



HEMPO2



HEMPO13

Ladeonderverdelingen in ABS. Langs- en dwarschotten. Leverbaar met 5, 6, 8, 10, 12 of 20 onderverdelingen.

Order nr.	Orig. nr.	Aantal afdelingen	Gewicht kg	Afmetingen (l x b x h) mm	Prijs €
761001765 €	HEMPO1	8	0,50	410 x 300 x 0	30,50
761001766 €	HEMPO2	10	0,50	410 x 300 x 0	30,50
761001767 €	HEMPO3	5	0,50	410 x 300 x 0	30,50
761001768 €	HEMPO4	12	0,50	410 x 300 x 0	30,50
761001769 €	HEMPO5	6	0,50	410 x 300 x 0	30,50
761001770 €	HEMPO6	20	0,50	410 x 300 x 0	30,50

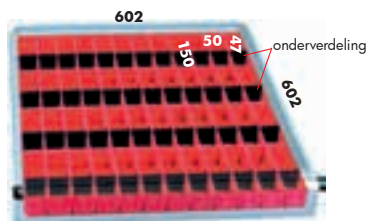

HE115075C1

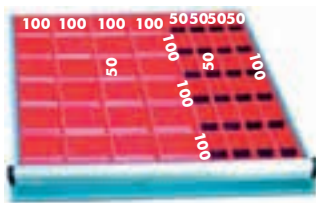

HE115075C2

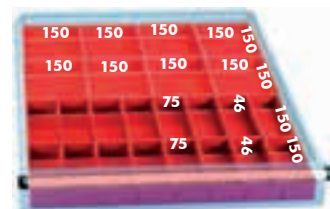

HE115075C3

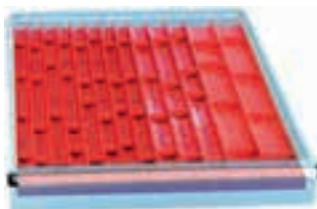

HE115075C4

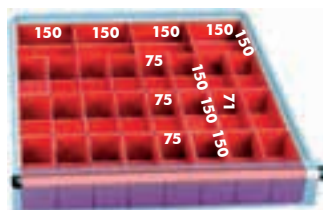

HE115125C1

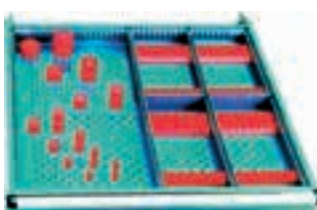

toepassing

Opdeling bakjes 600mm serie voor ladenkasten breedte 714 mm x diepte 707mm.

Order nr.	Orig. nr.	Hoogte mm	Gewicht kg	Prijs €
761000305	HE115075C1	75/100	2,99	59,50
761000306	HE115075C2	75/100	0,01	70,00
761000307	HE115075C3	75/100	0,01	207,00
761000308	HE115075C4	75/100	0,01	201,00
761000345	HE115125C1BL	125/150	0,01	295,00

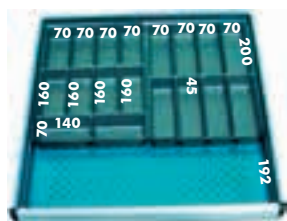

HE115MP01-02

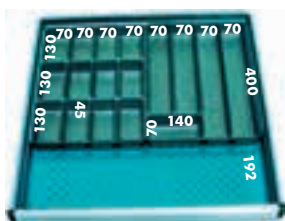

HE115MP03-04

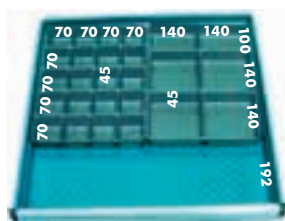

HE115MP05-06

Compactbakjes met onderverdelingen voor ladenkasten breedte 714mm x diepte 707mm. Van slagvaste ABS-kunststof. Onderverdeling per 15mm in grijs polystyrol. PS tray.

Order nr.	Orig. nr.	Hoogte mm	Breedte PS tray mm	Gewicht kg	Prijs €
761000481	HE115MP01-02	75/100	560	0,01	72,00
761000482	HE115MP03-04	75/100	560	0,01	72,00
761000483	HE115MP05-06	75/100	560	0,01	72,00

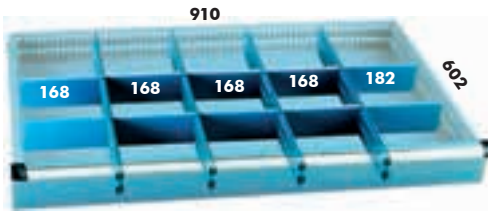

D3

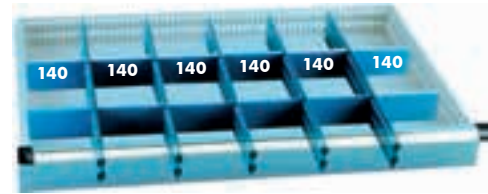

D4



D5

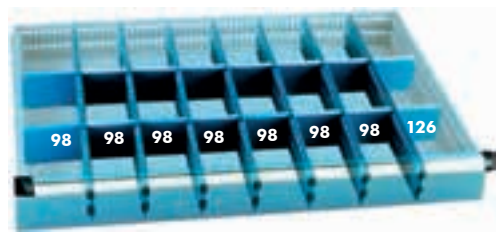

D6

Opdeling lade 910mm voor serie HE119 met breedte 1020mm, diepte 707mm. Langs- en dwarsschotten. In gepoederlakt staal. Leverbaar in verschillende hoogtes : 50, 100, 150, 200 en 250mm.

Order nr.	Orig. nr.	Type	Hoogte mm	Gewicht kg	Prijs €
761000550	HE119050D3BL	D3	50	2,31	61,00
761000554	HE119075D3BL	D3	75	3,16	56,00
761000559	HE119100D3BL	D3	100	3,92	64,00
761000577	HE119125D3BL	D3	125	5,42	68,00
761000594	HE119150D3BL	D3	150	6,03	77,50
761000600	HE119200D3BL	D3	200	9,11	99,00
761000631	HE119250D3BL	D3	250	10,49	120,00
761000551	HE119050D4BL	D4	50	2,51	71,00
761000555	HE119075D4BL	D4	75	3,38	63,00
761000560	HE119100D4BL	D4	100	4,36	72,00
761000578	HE119125D4BL	D4	125	5,78	81,50
761000595	HE119150D4BL	D4	150	6,74	89,50
761000601	HE119200D4BL	D4	200	9,53	118,00
761000632	HE119250D4BL	D4	250	11,74	129,00
761000552	HE119050D5BL	D5	50	1,97	22,50
761000556	HE119075D5BL	D5	75	2,59	32,50
761000561	HE119100D5BL	D5	100	3,15	34,90
761000579	HE119125D5BL	D5	125	4,28	37,50
761000596	HE119150D5BL	D5	150	4,72	43,90
761000602	HE119200D5BL	D5	200	6,91	53,00
761000633	HE119250D5BL	D5	250	8,58	63,00
761000553	HE119050D6BL	D6	50	2,95	99,00
761000557	HE119075D6BL	D6	75	3,94	85,50
761000562	HE119100D6BL	D6	100	5,20	92,50
761000580	HE119125D6BL	D6	125	7,03	111,00
761000597	HE119150D6BL	D6	150	8,04	118,00
761000603	HE119200D6BL	D6	200	11,69	136,00
761000634	HE119250D6BL	D6	250	14,20	164,00

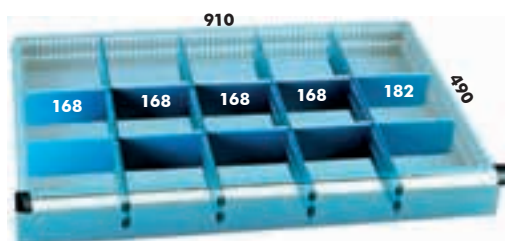

D1

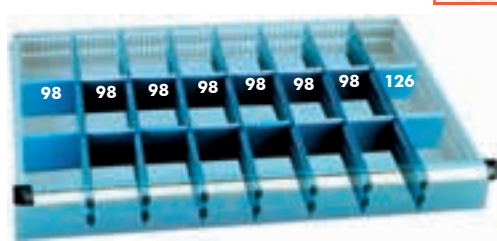

D2

Opdeling lade 910mm voor serie HE123 met breedte 1020mm, diepte 600mm. Langs- en dwarschotten. Van gepoederlakt staal. Leverbaar in verschillende hoogtes 75, 100, 125, 150, 200 en 250mm.

Order nr.	Orig. nr.	Type	Hoogte mm	Gewicht kg	Prijs €
761000773	HE123075D1BL	D1	75	2,95	53,00
761000775	HE123100D1BL	D1	100	3,49	59,50
761000777	HE123125D1BL	D1	125	4,74	63,00
761000779	HE123150D1BL	D1	150	5,43	71,00
761000782	HE123200D1BL	D1	200	8,27	99,00
761000793	HE123250D1BL	D1	250	9,41	120,00
761000774	HE123075D2BL	D2	75	3,57	74,00
761000776	HE123100D2BL	D2	100	4,45	85,50
761000778	HE123125D2BL	D2	125	5,79	102,00
761000780	HE123150D2BL	D2	150	6,96	106,00
761000783	HE123200D2BL	D2	200	10,18	136,00
761000794	HE123250D2BL	D2	250	12,34	164,00

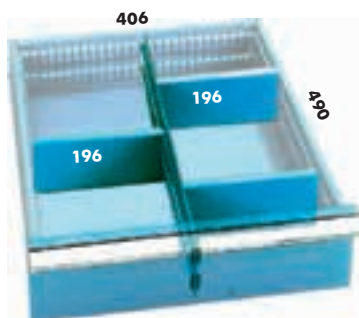

D1

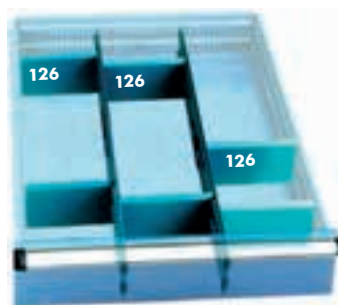

D2

Opdeling lade 406mm voor serie HE135 met breedte 515mm, diepte 600mm. Langs- en dwarschotten. In gepoederlakt staal. Leverbaar in verschillende hoogtes 75, 100, 125, 150, 200 en 250mm.

Order nr.	Orig. nr.	Type	Hoogte mm	Gewicht kg	Prijs €
761000936	HE135075D1BL	D1	75	1,48	14,50
761000941	HE135100D1BL	D1	100	1,67	15,90
761000953	HE135125D1BL	D1	125	1,97	19,50
761000956	HE135150D1BL	D1	150	2,26	19,50
761000961	HE135200D1BL	D1	200	2,89	23,50
761000973	HE135250D1BL	D1	250	3,45	30,50
761000937	HE135075D2BL	D2	75	1,83	23,50
761000942	HE135100D2BL	D2	100	2,13	28,50
761000954	HE135125D2BL	D2	125	2,61	31,50
761000957	HE135150D2BL	D2	150	3,14	36,00
761000962	HE135200D2BL	D2	200	4,60	42,90
761000974	HE135250D2BL	D2	250	5,01	58,50

HEBB



HE15210



HE15220



HE15215

OOK IN ANDERE
KLEUREN BESCHIKBAAR
■ ORIG NR MET EXTENSIE GE
■ ORIG NR MET EXTENSIE RE

EQUIPMENT

Werkbanken in stevige stalen constructie in blauwe hamerslagcoating. Bovenblad in metaal. Staaldikte 20/10.

- gelast
- hoge weerstand
- dikte bovenbladen 50mm
- leverbaar in diverse breedtes van 1000, 1500 en 2000mm
- voeten voorzien van een rubber top ter bescherming van de werkvloer

Order nr.	Orig. nr.	Gewicht kg	Afmetingen (l x b x h) mm	Prijs €
761001252	HE15210BL	78,00	1030 x 780 x 895	575,00
761001253	HE15215BL	105,00	1530 x 780 x 895	705,00
761001254	HE15220BL	132,00	2030 x 780 x 895	825,00

Heco werkbanken

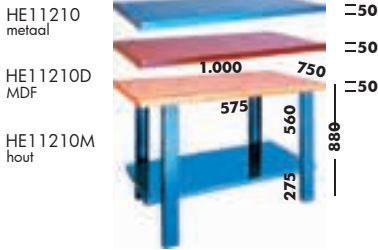

4 versterkingen gelast aan de binnenkant van de legplank, geperforeerd om de 55mm, om 1 of 2 ladenblokken aan te bevestigen



regelbare voeten in ge vulcaniseerde kunststof

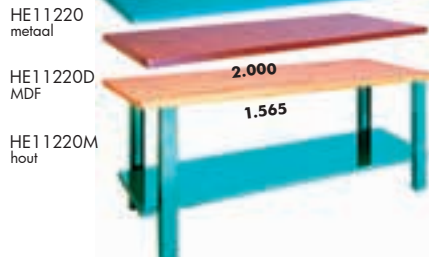

OOK IN ANDERE
KLEUREN BESCHIKBAAR
■ ORIG NR MET EXTENSIE GE
■ ORIG NR MET EXTENSIE RE

Werkbanken in stevige stalen constructie in blauwe hamerslagcoating. Bovenblad leverbaar ofwel in een metaal, MDF of massief kastanje hout. Staaldikte 20/10. Niet gemonteerd geleverd.

- dikte bovenbladen 50mm
- leverbaar in diverse breedtes van 1000, 1300, 1500, 1800 en 2000mm
- voeten voorzien van een rubber top ter bescherming van de werkvloer
- werkbanken kunnen worden voorzien van 1 of 2 ladeblokken (ladeblokken van 1 tot 4 laden)
- metalen bovenblad voorzien van versterkingen aan de onderkant. Max. draagvermogen gelijk verdeeld : 700kg

Order nr.	Orig. nr.	Bovenblad	Gewicht kg	Afmetingen (l x b x h) mm	Prijs €
761000195	HE11210BL	metaal	48,00	1000 x 750 x 880	341,00
761000207	HE11213BL	metaal	58,00	1300 x 750 x 880	387,00
761000219	HE11215BL	metaal	66,00	1500 x 750 x 880	432,00
761000233	HE11218BL	metaal	76,00	1800 x 750 x 880	473,00
761000245	HE11220BL	metaal	83,00	2000 x 750 x 880	519,00
761000197	HE11210DBL	MDF	56,00	1000 x 750 x 880	385,00
761000209	HE11213DBL	MDF	64,00	1300 x 750 x 880	441,00
761000222	HE11215DBL	MDF	71,00	1500 x 750 x 880	486,00
761000235	HE11218DBL	MDF	82,00	1800 x 750 x 880	545,00
761000247	HE11220DBL	MDF	92,00	2000 x 750 x 880	595,00
761000201	HE11210MBL	hout	51,00	1000 x 750 x 880	555,00
761000213	HE11213MBL	hout	60,00	1300 x 750 x 880	665,00
761000227	HE11215MBL	hout	68,00	1500 x 750 x 880	735,00
761000239	HE11218MBL	hout	77,00	1800 x 750 x 880	819,00
761000251	HE11220MBL	hout	83,00	2000 x 750 x 880	889,00



HE11210R
metaal

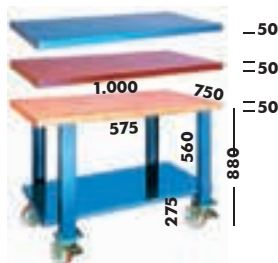

HE11210DR
MDF

HE11210MR
hout



4 versterkingen gelast aan de binnenkant van de legplank, geperforeerd om de 55mm, om 1 of 2 ladenblokken aan te bevestigen



HE11213
metaal



HE11213D
MDF

HE11213M
hout

HE11218R
metaal



HE11218DR
MDF

HE11218MR
hout

HE11215R
metaal



HE11215DR
MDF

HE11215MR
hout

HE11220R
metaal



HE11220DR
MDF

HE11220MR
hout

Werkbanken in stevige stalen constructie in blauwe hamerslagcoating. Bovenblad leverbaar ofwel in een metaal, MDF of massief kastanjehout. Staaldikte 20/10. Niet gemonteerd geleverd.

- 4 draaibare met PU-beklede nylonwielen diam. 150mm, waarvan 2 geremd.
- dikte bovenbladen 50mm
- leverbaar in diverse breedtes van 1000, 1300, 1500, 1800 en 2000mm
- voeten voorzien van een rubber top ter bescherming van de werkvloer
- werkbanken kunnen worden voorzien van 1 of 2 ladeblokken (ladeblokken van 1 tot 4 laden)
- metalen bovenblad voorzien van versterkingen aan de onderkant. Max. draagvermogen gelijk verdeeld : 700kg.

Order nr.	Orig. nr.	Bovenblad	Gewicht kg	Afmetingen (l x b x h) mm	Prijs €
761000206	HE11210RBL	metaal	60,00	1000 x 750 x 880	735,00
761000218	HE11213RBL	metaal	70,00	1300 x 750 x 880	775,00
761000232	HE11215RBL	metaal	78,00	1500 x 750 x 880	815,00
761000244	HE11218RBL	metaal	88,00	1800 x 750 x 880	845,00
761000256	HE11220RBL	metaal	95,00	2000 x 750 x 880	885,00
761000200	HE11210DRBL	MDF	67,00	1000 x 750 x 880	769,00
761000212	HE11213DRBL	MDF	76,00	1300 x 750 x 880	815,00
761000226	HE11215DRBL	MDF	83,00	1500 x 750 x 880	869,00
761000238	HE11218DRBL	MDF	94,00	1800 x 750 x 880	905,00
761000250	HE11220DRBL	MDF	104,00	2000 x 750 x 880	945,00
761000204	HE11210MRBL	hout	63,00	1000 x 750 x 880	935,00
761000216	HE11213MRBL	hout	72,00	1300 x 750 x 880	1.025,00
761000230	HE11215MRBL	hout	80,00	1500 x 750 x 880	1.105,00
761000242	HE11218MRBL	hout	89,00	1800 x 750 x 880	1.185,00
761000254	HE11220MRBL	hout	95,00	2000 x 750 x 880	1.255,00



HE11210PG
metaal



HE11210DPG
MDF



HE11210MPG
hout

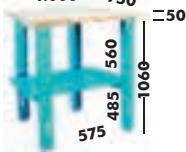

in de hoogte
verstelbare voeten



regelbare voeten in
ge vulcaniseerde kunststof

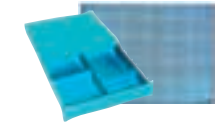

4 verstevigingen gelast aan de
binnenkant van de legplank,
geperforeerd om de 55mm, om 1 of
2 ladenblokken aan te bevestigen

ACCESSOIRES
p.518

VOETEN VERSTELBAAR

OOK IN ANDERE
KLEUREN BESCHIKBAAR

ORIG NR MET EXTENSIE GE
ORIG NR MET EXTENSIE RE

HE11213
metaal



HE11213D
MDF

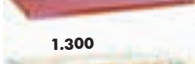

HE11213M
hout



HE11218
metaal



HE11218D
MDF



HE11218M
hout

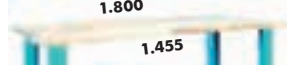

HE11215PG
metaal



HE11215DPG
MDF



HE11215M
hout

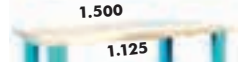

HE11220
metaal



HE11220D
MDF

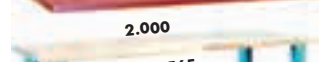

HE11220M
hout

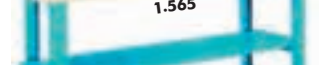

Werkbanken in stevige stalen constructie in blauwe hamerslagcoating. Bovenblad leverbaar ofwel in een metaal, MDF of massief kastanjehout. Staaldikte 20/10. Niet gemonteerd geleverd.

- in de hoogte (per 25mm) verstelbare voeten min/max 810/1060mm
- voeten voorzien van een ronde basis in ge vulcaniseerd rubber te bescherming van de werkvloer
- dikte bovenbladen 50mm
- leverbaar in diverse breedtes van 1000, 1300, 1500, 1800 en 2000mm
- voeten voorzien van een rubber top ter bescherming van de werkvloer
- werkbanken kunnen worden voorzien van 1 of 2 ladeblokken (ladeblokken van 1 tot 4 laden)
- metalen bovenblad voorzien van versterkingen aan de onderkant. Max. draagvermogen gelijk verdeeld : 700kg

Order nr.	Orig. nr.	Bovenblad	Gewicht kg	Afmetingen (l x b x h) mm	Prijs €
761000205	HE11210PGBL	metaal	48,00	1000 x 750 x 880	461,00
761000217	HE11213PGBL	metaal	48,00	1300 x 750 x 880	505,00
761000231	HE11215PGBL	metaal	48,00	1500 x 750 x 880	559,00
761000243	HE11218PGBL	metaal	48,00	1800 x 750 x 880	585,00
761000255	HE11220PGBL	metaal	83,00	2000 x 750 x 880	639,00
761000199	HE11210DPGBL	MDF	56,00	1000 x 750 x 880	515,00
761000211	HE11213DPGBL	MDF	56,00	1300 x 750 x 880	559,00
761000225	HE11215DPGBL	MDF	56,00	1500 x 750 x 880	625,00
761000237	HE11218DPGBL	MDF	56,00	1800 x 750 x 880	665,00
761000249	HE11220DPGBL	MDF	56,00	2000 x 750 x 880	705,00
761000203	HE11210MPGBL	hout	56,00	1000 x 750 x 880	689,00
761000215	HE11213MPGBL	hout	56,00	1300 x 750 x 880	765,00
761000229	HE11215MPGBL	hout	68,00	1500 x 750 x 880	849,00
761000241	HE11218MPGBL	hout	56,00	1800 x 750 x 880	925,00
761000253	HE11220MPGBL	hout	56,00	2000 x 750 x 880	995,00

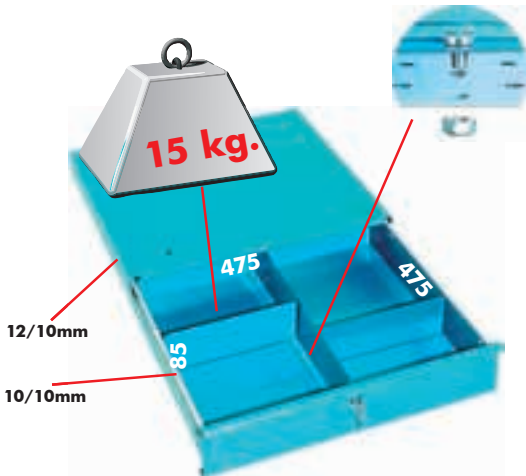

HE132



slot met sleutel

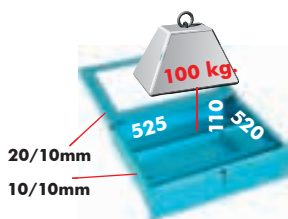
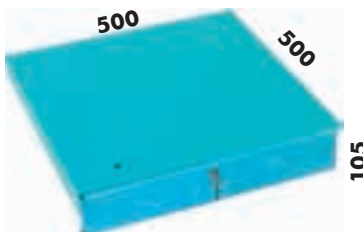

HE133

verwijderbare inglijdende legplaat

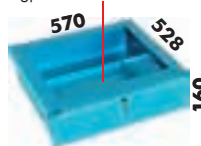

zonder onderverdelingen

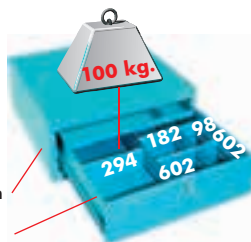

HE129

verwijderbare inglijdende legplaat

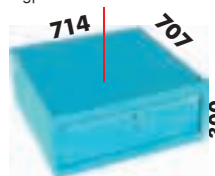

Ladeblok voor werkbanken serie HE112.

- staaldikte variërend tussen 10/10, 12/10 en 15/10
- individueel afsluitbaar met sleutel
- compartimentering inbegrepen cfr. afbeeldingen
- wordt bevestigd aan de versterkingbalken in geval van een metalen topblad, in geval van houten of MDF bovenblad worden de ladeblokken met schroefbouten bevestigd (type bovenblad te vermelden bij bestelling).

Order nr.	Orig. nr.	Aantal laden	Afmetingen lade (1) mm	Afmetingen lade (2) mm	Afmetingen lade (3) mm	Afmetingen lade (4) mm	Gewicht	Afmetingen (l x b x h) mm	Prijs
							kg		€
761000287	HE113110OBL	1	602x602x100	-	-	-	28,00	714 x 707 x 200	311,00
761000288	HE113120OBL	1	602x602x200	-	-	-	29,00	714 x 707 x 300	324,00
761000289	HE1132BL	2	602x602x75	602x602x125	-	-	37,00	714 x 707 x 300	464,00
761000290	HE1133BL	3	602x602x75	602x602x100	602x602x125	-	60,00	714 x 707 x 400	635,00
761000291	HE1134BL	4	602x602x75	602x602x75	602x602x125	602x602x125	76,00	714 x 707 x 500	775,00
761000914	HE129BL	1	602x602x200	-	-	-	34,90	714 x 707 x 300	322,00
761000918	HE132BL	1	475x475x85	-	-	-	9,00	500 x 500 x 105	88,50
761000919	HE133BL	1	525x520x110	-	-	-	12,90	570 x 528 x 160	129,00
761001255	HE153110OBL	1	406x490x100	-	-	-	18,00	515 x 600 x 200	242,00
761001256	HE153120OBL	1	378x490x200	-	-	-	21,00	515 x 600 x 300	272,00
761001257	HE1532BL	2	378x490x75	378x490x125	-	-	24,00	515 x 600 x 300	368,00
761001258	HE1533BL	3	378x490x75	378x490x100	378x490x125	-	37,50	515 x 600 x 400	476,00
761001259	HE1534BL	4	-	-	-	-	48,00	515 x 600 x 500	599,00

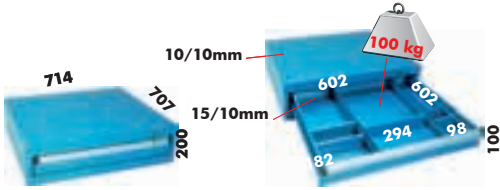

HE1131100

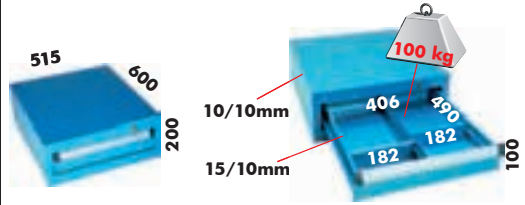

HE1531100

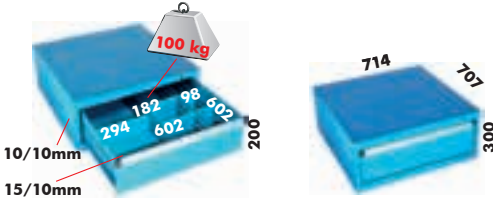

HE1131200

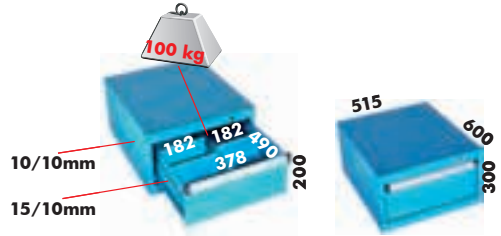

HE1531200

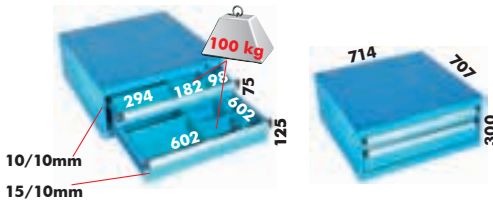

HE1132

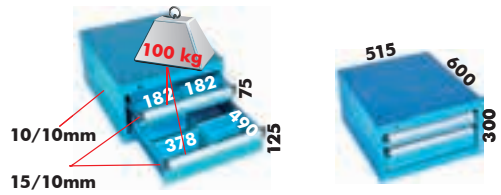

HE1532

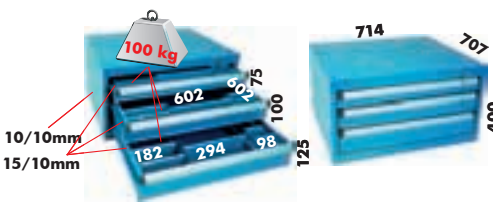

HE1133

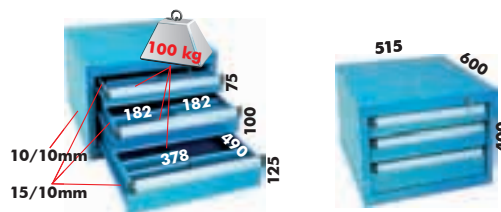

HE1533

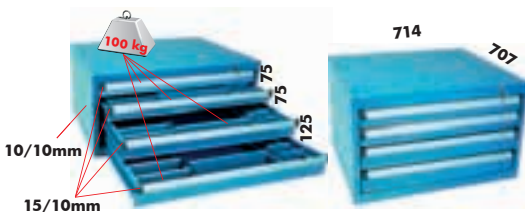

HE1134

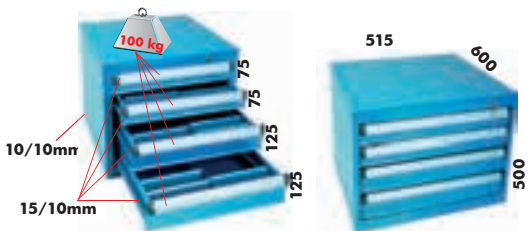

HE1534



HE10913 + HE1133 + HE15013AM

EQUIPMENT

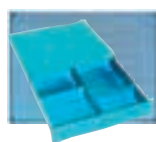

ACCESSOIRES

p.518

**OOK IN ANDERE
KLEUREN BESCHIKBAAR**

ORIG NR MET EXTENSIE GE
 ORIG NR MET EXTENSIE RE



4 verstevigingen gelast aan de binnenkant van de legplank, geperforeerd om de 55mm, om 1 of 2 ladenblokken aan te bevestigen



regelbare poten in gevulniseerde kunststof



ook leverbaar met opstaande rand (HE150P)
zie www.vynckier.biz

Werkbanken in stevige stalen constructie in blauwe hamerslagcoating. Bovenblad leverbaar ofwel in een metaal, MDF of massief kastanjehout. Staaldikte 20/10. Niet gemonteerd geleverd.

- dikte bovenbladen 50mm
- leverbaar in diverse breedtes van 1000, 1300, 1500, 1800 en 2000mm
- voeten voorzien van een rubber top ter bescherming van de werkvloer
- werkbanken kunnen worden voorzien van 1 of 2 ladeblokken (ladeblokken van 1 tot 4 laden)

Order nr.	Orig. nr.	Bovenblad	Gewicht kg	Afmetingen (l x b x h) mm	Prijs €
761001148	HE15010ABL	metaal	81,00	1000 x 750 x 880	515,00
761001166	HE15013ABL	metaal	94,00	1300 x 750 x 880	585,00
761001183	HE15015ABL	metaal	105,00	1500 x 750 x 880	639,00
761001201	HE15018ABL	metaal	120,00	1800 x 750 x 880	709,00
761001218	HE15020ABL	metaal	126,00	2000 x 750 x 880	615,00
761001149	HE15010ADBL	MDF	82,00	1000 x 750 x 880	515,00
761001167	HE15013ADBL	MDF	94,00	1300 x 750 x 880	585,00
761001184	HE15015ADBL	MDF	103,00	1500 x 750 x 880	645,00
761001202	HE15018ADBL	MDF	117,00	1800 x 750 x 880	709,00
761001219	HE15020ADBL	MDF	129,00	2000 x 750 x 880	615,00
761001150	HE15010AMBL	hout	77,00	1000 x 750 x 880	695,00
761001168	HE15013AMBL	hout	90,00	1300 x 750 x 880	795,00
761001185	HE15015AMBL	hout	100,00	1500 x 750 x 880	865,00
761001203	HE15018AMBL	hout	112,00	1800 x 750 x 880	975,00
761001220	HE15020AMBL	hout	120,00	2000 x 750 x 880	909,00

HE15010A
metaal

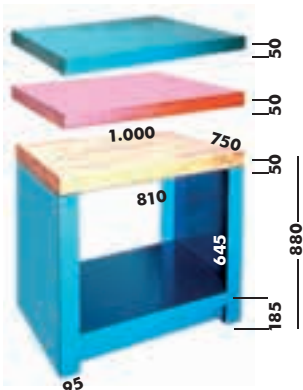

HE15010AD
MDF

HE15010AM
hout

HE15018A
metaal

HE15018AD
MDF

HE15018AM
hout



HE15013A
metaal

HE15013AD
MDF

HE15013AM
hout

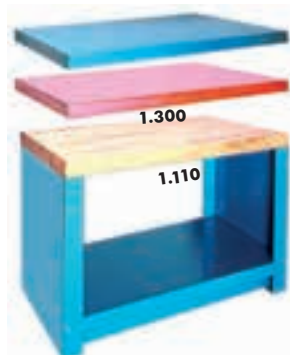

HE15020A
metaal

HE15020AD
MDF

HE15020AM
hout



HE15015A
metaal

HE15015AD
MDF

HE15015AM
hout



EQUIPMENT



HE150S

EQUIPMENT

Werkbanken in stevige stalen constructie in blauwe hamerslagcoating. Bovenblad leverbaar ofwel in een metaal, MDF of massief kastanjehout. Staaldikte 20/10. Niet gemonteerd geleverd.

- dikte bovenbladen 50mm
- leverbaar in diverse breedtes van 1000, 1300, 1500, 1800 en 2000mm
- voeten voorzien van een rubber top ter bescherming van de werkvloer
- werkbanken kunnen worden voorzien van 1 of 2 ladeblokken (ladeblokken van 1 tot 4 laden)
- metalen bovenblad voorzien van versterkingen aan de onderkant. Max. draagvermogen gelijk verdeeld : 700kg.

Order nr.	Orig. nr.	Bovenblad	Gewicht kg	Afmetingen (l x b x h) mm	Prijs €
761001154	HE15010SBL	metaal	90,00	1000 x 750 x 880	675,00
761001172	HE15013SBL	metaal	105,00	1300 x 750 x 880	729,00
761001189	HE15015SBL	metaal	116,00	1500 x 750 x 880	779,00
761001207	HE15018SBL	metaal	132,00	1800 x 750 x 880	855,00
761001224	HE15020SBL	metaal	142,00	1800 x 750 x 880	775,00
761001155	HE15010SDBL	MDF	97,00	1000 x 750 x 880	699,00
761001173	HE15013SDBL	MDF	111,00	1300 x 750 x 880	779,00
761001190	HE15015SDBL	MDF	121,00	1500 x 750 x 880	815,00
761001208	HE15018SDBL	MDF	137,00	1800 x 750 x 880	889,00
761001225	HE15020SDBL	MDF	151,00	2000 x 750 x 880	805,00
761001156	HE15010SMBL	metaal	92,00	1000 x 750 x 880	845,00
761001174	HE15013SMBL	metaal	107,00	1300 x 750 x 880	975,00
761001191	HE15015SMBL	metaal	118,00	1500 x 750 x 880	1.055,00
761001209	HE15018SMBL	metaal	132,00	1800 x 750 x 880	1.165,00
761001226	HE15020SMBL	metaal	142,00	2000 x 750 x 880	1.105,00



HE150101



HE150102



HE150103

Set werkbank-kast in stevige stalen constructie in blauwe hamerslagcoating. Bovenblad leverbaar ofwel in een metaal, MDF of massief kastanjehout. Staaldikte 20/10. Kasten met zeefdruk of met geperforeerd paneel. Niet gemonteerd geleverd.

- dikte bovenbladen 50mm
- breedte 1000mm, 1300mm, 1500mm, 1800mm of 2000mm
- voeten voorzien van een rubber pot ter bescherming van de werkvloer

Order nr.	Orig. nr.	Bovenblad	Kast type	Gewicht kg	Afmetingen (l x b x h) mm	Prijs €
761001142	HE150101BL	metaal	Zeefdruk paneel	114,00	1000 x 750 x 880	1.069,00
761001143	HE150102BL	metaal	Geperforeerd paneel	112,00	1000 x 750 x 880	1.015,00
761001144	HE150103BL	DM	Zeefdruk paneel	120,00	1000 x 750 x 880	1.095,00
761001145	HE150104BL	DM	Geperforeerd paneel	118,00	1000 x 750 x 880	1.045,00
761001146	HE150105BL	hout	Zeefdruk paneel	117,00	1000 x 750 x 880	1.259,00
761001147	HE150106BL	hout	Geperforeerd paneel	115,00	1000 x 750 x 880	1.205,00
761001160	HE150131BL	metaal	Zeefdruk paneel	133,00	1300 x 750 x 880	1.195,00
761001161	HE150132BL	metaal	Geperforeerd paneel	133,00	1300 x 750 x 880	1.125,00
761001162	HE150133BL	DM	Zeefdruk paneel	142,00	1300 x 750 x 880	1.245,00
761001163	HE150134BL	DM	Geperforeerd paneel	142,00	1300 x 750 x 880	1.169,00
761001164	HE150135BL	hout	Zeefdruk paneel	137,00	1300 x 750 x 880	1.429,00
761001165	HE150136BL	hout	Geperforeerd paneel	137,00	1300 x 750 x 880	1.375,00
761001177	HE150151BL	metaal	Zeefdruk paneel	146,00	1500 x 750 x 880	1.279,00
761001178	HE150152BL	metaal	Geperforeerd paneel	145,00	1500 x 750 x 880	1.195,00
761001179	HE150153BL	DM	Zeefdruk paneel	155,00	1500 x 750 x 880	1.315,00
761001180	HE150154BL	DM	Geperforeerd paneel	161,00	1500 x 750 x 880	1.229,00
761001181	HE150155BL	hout	Zeefdruk paneel	150,00	1500 x 750 x 880	1.529,00
761001182	HE150156BL	hout	Geperforeerd paneel	149,00	1500 x 750 x 880	1.445,00
761001195	HE150181BL	metaal	Zeefdruk paneel	167,00	1800 x 750 x 880	1.375,00
761001196	HE150182BL	metaal	Geperforeerd paneel	166,00	1800 x 750 x 880	1.319,00
761001197	HE150183BL	DM	Zeefdruk paneel	179,00	1800 x 750 x 880	1.389,00
761001198	HE150184BL	DM	Geperforeerd paneel	178,00	1800 x 750 x 880	1.355,00
761001199	HE150185BL	hout	Zeefdruk paneel	152,00	1800 x 750 x 880	1.665,00
761001200	HE150186BL	hout	Geperforeerd paneel	151,00	1800 x 750 x 880	1.615,00
761001212	HE150201BL	metaal	Zeefdruk paneel	171,00	2000 x 750 x 880	1.349,00
761001213	HE150202BL	metaal	Geperforeerd paneel	171,00	2000 x 750 x 880	1.255,00
761001214	HE150203BL	DM	Zeefdruk paneel	183,00	2000 x 750 x 880	1.395,00
761001215	HE150204BL	DM	Geperforeerd paneel	183,00	2000 x 750 x 880	1.295,00
761001216	HE150205BL	hout	Zeefdruk paneel	156,00	2000 x 750 x 880	1.675,00
761001217	HE150206BL	hout	Geperforeerd paneel	156,00	2000 x 750 x 880	1.579,00



Werkbanken in stevige stalen constructie in blauwe hamerslagcoating. Bovenblad leverbaar in metaal of MDF. Staaldikte 15/20/10. Niet gemonteerd geleverd.

- dikte bovenbladen 40mm
- leverbaar in diverse breedtes van 1000, 1500 tot 2000mm
- voeten voorzien van een rubber top ter bescherming van de werkvloer

Order nr.	Orig. nr.	Bovenblad	Gewicht kg	Afmetingen (l x b x h) mm	Prijs €
761000126	HE1111001BL	MDF	104,00	1000 x 750 x 880	795,00
761000127	HE1111001CBL	metaal	104,00	1000 x 750 x 880	719,00
761000128	HE1111002BL	MDF	145,00	1000 x 750 x 880	1.635,00
761000129	HE1111002CBL	metaal	145,00	1000 x 750 x 880	1.545,00
761000130	HE1111003BL	MDF	127,00	1000 x 750 x 880	1.275,00
761000131	HE1111003CBL	metaal	127,00	1000 x 750 x 880	1.189,00
761000132	HE1111004BL	MDF	104,00	1000 x 750 x 880	895,00
761000133	HE1111004CBL	metaal	99,00	1000 x 750 x 880	805,00
761000134	HE1111005BL	MDF	112,00	1000 x 750 x 880	1.009,00
761000135	HE1111005CBL	metaal	107,00	1000 x 750 x 880	925,00
761000136	HE1111006BL	MDF	118,00	1000 x 750 x 880	1.135,00
761000137	HE1111006CBL	metaal	113,00	1000 x 750 x 880	1.045,00
761000138	HE1111007BL	MDF	111,00	1000 x 750 x 880	989,00
761000139	HE1111007CBL	metaal	106,00	1000 x 750 x 880	905,00
761000142	HE1111501BL	MDF	117,00	1500 x 750 x 880	1.139,00
761000143	HE1111501CBL	metaal	110,00	1500 x 750 x 880	1.025,00
761000144	HE1111502BL	MDF	125,00	1500 x 750 x 880	1.355,00
761000145	HE1111502CBL	metaal	118,00	1500 x 750 x 880	1.245,00
761000146	HE1111503BL	MDF	166,00	1500 x 750 x 880	2.099,00
761000147	HE1111503CBL	metaal	159,00	1500 x 750 x 880	1.989,00
761000148	HE1111504BL	MDF	199,00	1500 x 750 x 880	2.735,00
761000149	HE1111504CBL	metaal	192,00	1500 x 750 x 880	2.629,00
761000150	HE1111505BL	MDF	181,00	1500 x 750 x 880	2.365,00
761000151	HE1111505CBL	metaal	174,00	1500 x 750 x 880	2.255,00
761000152	HE1111506BL	MDF	130,00	1500 x 750 x 880	1.459,00
761000153	HE1111506CBL	metaal	123,00	1500 x 750 x 880	1.369,00
761000154	HE1111507BL	MDF	132,00	1500 x 750 x 880	1.439,00
761000155	HE1111507CBL	metaal	125,00	1500 x 750 x 880	1.349,00
761000156	HE1111508BL	MDF	153,00	1500 x 750 x 880	1.829,00
761000157	HE1111508CBL	metaal	146,00	1500 x 750 x 880	1.719,00
761000160	HE1112001BL	MDF	177,00	2000 x 750 x 880	2.049,00
761000161	HE1112001CBL	metaal	168,00	2000 x 750 x 880	1.905,00
761000162	HE1112002BL	MDF	163,00	2000 x 750 x 880	1.785,00
761000163	HE1112002CBL	metaal	154,00	2000 x 750 x 880	1.645,00
761000164	HE1112003BL	MDF	153,50	2000 x 750 x 880	1.665,00
761000165	HE1112003CBL	metaal	144,50	2000 x 750 x 880	1.515,00
761000166	HE1112004BL	MDF	186,50	2000 x 750 x 880	2.305,00
761000167	HE1112004CBL	metaal	177,50	2000 x 750 x 880	2.155,00
761000168	HE1112005BL	MDF	227,50	2000 x 750 x 880	3.065,00
761000169	HE1112005CBL	metaal	218,50	2000 x 750 x 880	2.919,00
761000170	HE1112006BL	MDF	250,50	2000 x 750 x 880	2.525,00
761000171	HE1112006CBL	metaal	241,50	2000 x 750 x 880	3.405,00
761000172	HE1112007BL	MDF	216,50	2000 x 750 x 880	2.895,00
761000173	HE1112007CBL	metaal	207,50	2000 x 750 x 880	2.745,00
761000174	HE1112008BL	MDF	182,00	2000 x 750 x 880	2.235,00
761000175	HE1112008CBL	metaal	173,00	2000 x 750 x 880	2.089,00

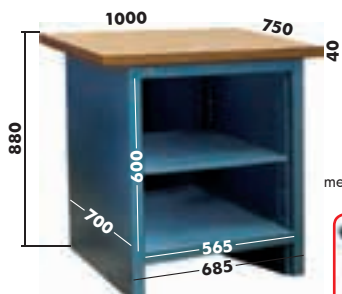

HE1111001



met regelbare poten



HE1111001C



H100mm
H100mm
H100mm
H100mm
H100mm
H100mm

HE1111002



HE1111002C



H200mm
H200mm
H200mm

HE1111003



HE1111003C



HE1111004



HE1111004C



H200mm

HE1111005



HE1111005C



H100mm
H100mm

HE1111006



HE1111006C



H100mm

HE1111007



HE1111007C



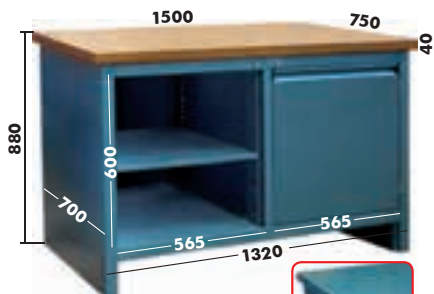

HE1111501



HE1111501C

H200mm



HE1111502



HE1111502C



H200mm

H100mm
H100mm
H100mm
H100mm
H100mm

HE1111503



HE1111503C



H100mm
H100mm
H100mm
H100mm
H100mm
H100mm
H100mm

H100mm
H100mm
H100mm
H100mm
H100mm
H100mm

HE1111504



HE1111504C



H200mm

H200mm

H200mm

H100mm
H100mm
H100mm
H100mm
H100mm

HE1111505



HE1111505C

H200mm



H200mm

HE1111506



HE1111506C



H100mm

H200mm

HE1111507



HE1111507C

H100mm



H100mm

H100mm

HE1111508



HE1111508C

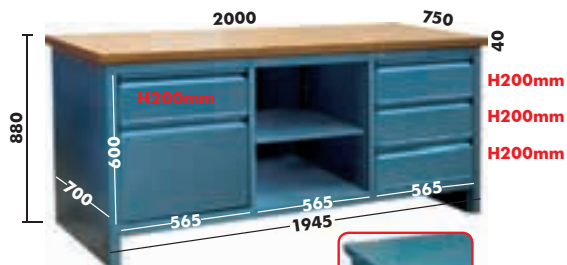

HE1112001



HE1112001C



HE1112002



HE1112002C



HE1112003



HE1112003C



HE1112004



HE1112004C



HE1112005



HE1112005C



HE1112006



HE1112006C



HE1112007



HE1112007C



HE1112008



HE1112008C

EQUIPMENT



HE11010



HE11115

Werkbanken zonder laden, deuren en legplanken.

Order nr.	Orig. nr.	Bovenblad	Gewicht kg	Afmetingen (l x b x h) mm	Prijs €
761000125	HE11110BL	MDF	100,00	1000 x 750 x 880	759,00
761000140	HE11110CBL	metaal	100,00	1000 x 750 x 880	665,00
761000141	HE11115BL	MDF	109,00	1500 x 750 x 880	945,00
761000158	HE11115CBL	metaal	109,00	1500 x 750 x 880	835,00
761000159	HE11120BL	MDF	133,50	2000 x 750 x 880	1.235,00
761000176	HE11120CBL	metaal	133,50	2000 x 750 x 880	1.089,00



centraal slot

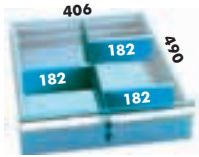

laden geleverd met 1 scheidingswand en 3 tussenschotten (behalve 300mm)

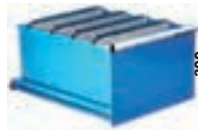

lade 300mm met houder voor 60 mappen



kasten standaard met 1 in de hoogte verstelbaar legbord



accessoires vanaf p. 518

HE13618C2

HE13618D2

HE13618M2

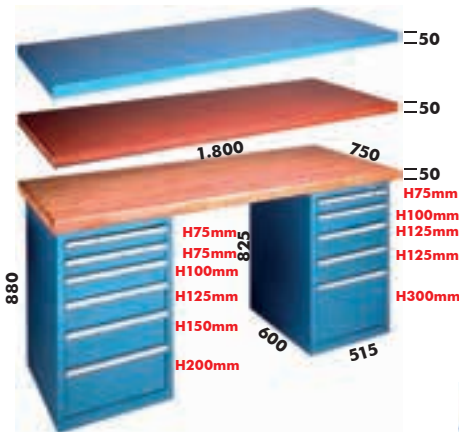

HE13620C2

HE13620D2

HE13620M2



Werkbanken in stevige stalen constructie in blauwe hamerslagcoating. Bovenblad leverbaar in metaal, MDF of massief kastanjehout. Staaldikte 20/10. Gemonteerd geleverd.

- breedte 1800 of 2000mm
- werkhoogte 880mm
- diepte en dikte van het bovenblad 750/50mm
- combinatie van bovenblad met 2 ladenkasten (6 laden en 5 laden)
- laden 90% uittrekbaar met draagvermogen van 100kg
- lade hoogte 300mm voorzien van houders voor 60 mappen (niet incl.)
- alle laden worden geleverd met 1 scheidingswand en 3 insteekschotjes
- alle ladenkasten zijn met een sleutel afsluitbaar

Order nr.	Orig. nr.	Bovenblad	Gewicht kg	Afmetingen (l x b x h) mm	Prijs €
761001006	HE13618C2BL	metaal	163,00	1800 x 623 x 880	2.335,00
761001011	HE13618D2BL	MDF	172,00	1800 x 623 x 880	2.375,00
761001016	HE13618M2BL	hout	165,00	1800 x 623 x 880	2.645,00
761001020	HE13620C2BL	metaal	174,00	2000 x 623 x 880	2.365,00
761001025	HE13620D2BL	MDF	186,00	2000 x 623 x 880	2.405,00
761001029	HE13620M2BL	hout	172,00	2000 x 623 x 880	2.705,00

HECO

HE13615C1

HE13615D1

HE13615M1



1.500

HE13618C1

HE13618D1

HE13618M1



1.800

HE13620C1

HE13620D1

HE13620M1



2.000

VOET + LADENKAST

OOK IN ANDERE
KLEUREN BESCHIKBAAR

■ ORIG NR MET EXTENSIE GE

■ ORIG NR MET EXTENSIE RE

EQUIPMENT

Werkbanken in stevige stalen constructie in blauwe hamerslagcoating. Bovenblad leverbaar in metaal, MDF of massief kastanjehout. Staaldikte 20/10. Gemonteerd geleverd.

- leverbaar in breedte 1500, 1800 en 2000mm
- werkhoogte 880mm
- diepte en dikte van het bovenblad 750/50mm
- combinatie van bovenblad met 1 ladenkast (5 laden) en 1 vaste voet
- laden 90% uittrekbaar met draagvermogen van 100kg
- lade hoogte 300mm voorzien van houders voor 60 mappen (niet incl.)
- alle laden worden geleverd met 1 scheidingswand en 3 insteekschotjes
- alle laden zijn met een sleutel afsluitbaar

Order nr.	Orig. nr.	Bovenblad	Gewicht kg	Afmetingen (l x b x h) mm	Prijs €
761000998	HE13615C1BL	metaal	102,00	1500 x 623 x 880	1.365,00
761001000	HE13615D1BL	MDF	110,00	1500 x 623 x 880	1.395,00
761001002	HE13615M1BL	hout	105,00	1500 x 623 x 880	1.605,00
761001004	HE13618C1BL	metaal	111,00	1800 x 623 x 880	1.395,00
761001009	HE13618D1BL	MDF	121,00	1800 x 623 x 880	1.409,00
761001014	HE13618M1BL	hout	111,00	1800 x 623 x 880	1.685,00
761001019	HE13620C1BL	metaal	117,00	2000 x 623 x 880	1.405,00
761001024	HE13620D1BL	MDF	129,00	2000 x 623 x 880	1.439,00
761001028	HE13620M1BL	hout	115,00	2000 x 623 x 880	1.739,00

HE13615C11

HE13615D11

HE13615M11



HE13618C11

HE13618D11

HE13618M11



VOET + KAST

OOK IN ANDERE
KLEUREN BESCHIKBAAR

■ ORIG. NR. MET EXTENSIE GE

■ ORIG. NR. MET EXTENSIE RE

Werkbanken in stevige stalen constructie in blauwe hamerslagcoating. Bovenblad leverbaar in metaal, MDF of massief kastanjehout. Staaldikte 20/10. Gemonteerd geleverd.

- leverbaar in breedte 1800 en 2000mm
- werkhoogte 880mm
- diepte en dikte van het bovenblad 750/50mm
- combinatie van bovenblad met 1 kast met 2 deuren en 1 vaste voet
- laden 90% uittrekbaar met draagvermogen van 100kg
- kast geleverd met 1 in de hoogte per 25mm verstelbaar legbord
- alle ladenkasten zijn met een sleutel afsluitbaar

Order nr.	Orig. nr.	Bovenblad	Gewicht kg	Afmetingen (l x b x h) mm	Prijs €
761000999	HE13615C11BL	metaal	74,00	1500 x 623 x 880	875,00
761001001	HE13615D11BL	MDF	82,00	1500 x 623 x 880	905,00
761001003	HE13615M11BL	hout	77,00	1500 x 623 x 880	1.145,00
761001005	HE13618C11BL	metaal	83,00	1800 x 623 x 880	905,00
761001010	HE13618D11BL	MDF	93,00	1800 x 623 x 880	945,00
761001015	HE13618M11BL	hout	83,00	1800 x 623 x 880	1.219,00



HE13620C21

HE13620D21

HE13620M21



KAST + LADENKAST

**OOK IN ANDERE
KLEUREN BESCHIKBAAR**

■ ORIG NR MET EXTENSIE GR

■ ORIG NR MET EXTENSIE RE

HE13618C21

HE13618D21

HE13618M21



Werkbanken in stevige stalen constructie in blauwe hamerslagcoating. Bovenblad leverbaar in metaal, MDF of massief kastanjehout. Staaldikte 20/10. Gemonteerd geleverd.

- leverbaar in breedte 1800 en 2000mm
- werkhoogte 880mm
- diepte en dikte van het bovenblad 750/50mm
- combinatie van bovenblad met 1 ladenkast (5 laden) en 1 kast met 2 deuren
- laden 90% uittrekbaar met draagvermogen van 100kg
- lade hoogte 300mm voorzien van houders voor 60 mappen (niet incl.)
- alle laden worden geleverd met 1 scheidingswand en 3 insteekschotjes
- kast geleverd met 1 in de hoogte per 25mm verstelbaar legbord
- alle ladenkasten zijn met een sleutel afsluitbaar

Order nr.	Orig. nr.	Bovenblad	Gewicht kg	Afmetingen (l x b x h) mm	Prijs €
761001007	HE13618C21BL	metaal	135,00	1800 x 623 x 880	1.659,00
761001012	HE13618D21BL	MDF	145,00	1800 x 623 x 880	1.695,00
761001017	HE13618M21BL	hout	135,00	1800 x 623 x 880	1.969,00
761001021	HE13620C21BL	metaal	141,00	2000 x 623 x 880	1.689,00
761001026	HE13620D21BL	MDF	153,00	2000 x 623 x 880	1.725,00
761001030	HE13620M21BL	hout	139,00	2000 x 623 x 880	2.025,00

HE13618C22

HE13618D22

HE13618M22



2 KASTEN

OOK IN ANDERE
KLEUREN BESCHIKBAAR

■ ORIG NR MET EXTENSIE GE
■ ORIG NR MET EXTENSIE RE

HE13620C22

HE13620D22

HE13620M22



Werkbanken in stevige stalen constructie in blauwe hamerslagcoating. Bovenblad leverbaar in metaal, MDF of massief kastanjehout. Staaldikte 20/10. Gemonteerd geleverd.

- leverbaar in breedte 1800 en 2000mm
- werkhogte 880mm
- diepte en dikte van het bovenblad 750/50mm
- combinatie van bovenblad met 2 kasten met 2 deuren
- laden 90% uittrekbaar met draagvermogen van 100kg
- kasten geleverd met 1 in de hoogte per 25mm verstelbaar legbord
- alle ladenkasten zijn met een sleutel afsluitbaar

Order nr.	Orig. nr.	Bovenblad	Gewicht kg	Afmetingen (l x b x h) mm	Prijs €
761001008	HE13618C22BL	metaal	107,00	1800 x 623 x 880	925,00
761001013	HE13618D22BL	MDF	117,00	1800 x 623 x 880	965,00
761001018	HE13618M22BL	hout	107,00	1800 x 623 x 880	1.245,00
761001022	HE13620C22BL	metaal	113,00	2000 x 623 x 880	959,00
761001027	HE13620D22BL	MDF	125,00	2000 x 623 x 880	995,00
761001031	HE13620M22BL	hout	111,00	2000 x 623 x 880	1.299,00



HE1151M



HE1191M



HE1350M



HE1351M



anti-omkeer mechanisme



HE135M voorzien om onder een werkbank te plaatsen



legbord met kunststof mat centraal slot



laden 90% uittrekbaar met draagcapaciteit 100kg

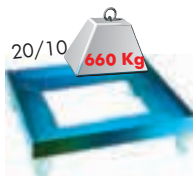

2 vaste wielen en 2 roterende wielen



wielen in nylon Ø100 mm. band in polyurethaan

Mobiele kasten. Ideaal voor gebruik onder een werkbank. In plaatstaal 10/10mm. Voorzien van 1 lade-blokkering en slot met centrale sluiting. Stevige nylonwielen diam. 100mm. Lade capaciteit 100kg, totale draagcapaciteit 660kg. Bovenvak met rubbermat. Zonder compartimenten.

Order nr.	Orig. nr.	Gewicht kg	Afmetingen (l x b x h) mm	Prijs €
761000939	HE1350MBL	63,00	505 x 600 x 790	1.045,00
761000959	HE1351MBL	75,00	505 x 600 x 865	1.185,00
761000372	HE1151MBL	112,00	712 x 705 x 865	1.395,00
761000598	HE1191MBL	132,00	1020 x 705 x 865	1.655,00



Uiterst stevige, mobiele werkbank met verzinkte plaat of brikethout. Met handvaten en kunststof anti-slip voeten. Staaldikte 20/10

Order nr.	761000712	761000711
Orig. nr.	HE120105BL	HE120101BL
Gewicht	kg 21,60	23,62
Afmetingen (l x b x h)	mm 970 x 510 x 840	970 x 510 x 840
Prijs	€ 245,00	299,00



Werkbank met 3 legplanken. Staaldikte 20/10.

Order nr.	761001032
Orig. nr.	HE137BL
Gewicht	kg 42,60
Afmetingen (l x b x h)	mm 1220 x 600 x 1050
Prijs	€ 214,00

Heco muurkasten



HE145 20 + 136 20 C2

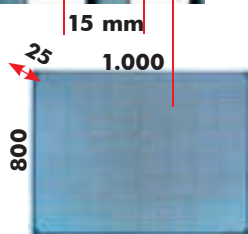
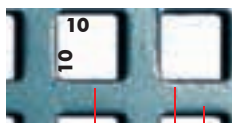

HE14510



HE145101



EQUIPMENT



HE14513



HE145131



HE14515



HE145151

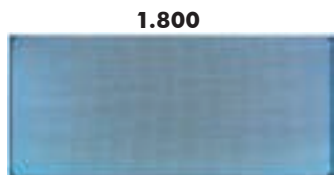

HE14518



HE145181

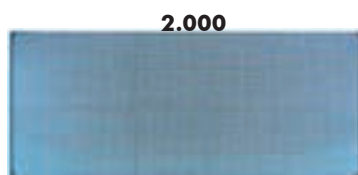

HE14520



HE145201

Wandplaat met geperforeerde achterwand. Staalplaatconstructie in blauwe hamerslagcoating.

- diepte en hoogte : 25/800mm
- leverbaar in breedte 1000, 1300, 1500, 1800 en 2000mm
- geleverd zonder haken en gereedschapshouders

Order nr.	Orig. nr.	Perforatie mm	Hart-op-hart afstand mm	Gewicht kg	Afmetingen (l x b x h) mm	Prijs €
761001106	HE14510BL	10x10	15x15	9,56	1000 x 800 x 25	98,00
761001109	HE14513BL	10x10	15x15	12,00	1300 x 800 x 25	119,00
761001111	HE14515BL	10x10	15x15	13,20	1500 x 800 x 25	137,00
761001113	HE14518BL	10x10	15x15	16,50	1800 x 800 x 25	145,00
761001115	HE14520BL	10x10	15x15	19,10	2000 x 800 x 25	161,00



HE11215 + 14515C + HE145CTP + HEV-BULL1 + HEV-BULL2

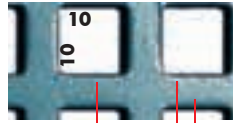

15 mm

1.300



HE14513C



HE145131



1.000
800



HE14510C



HE145101

1.800

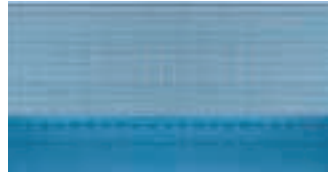

HE14518C



HE145181

1.500



HE14515C



HE145151

2.000



HE14520C

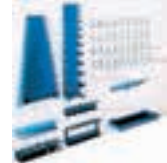

HE145201

Wandplaat met geperforeerde achterwand en bakjes steun. Perforatie met 10/10mm vierkant profiel. Staalplaatconstructie in blauwe hamerslagcoating.

- diepte en hoogte 15/800mm
- leverbaar in breedte 1000, 1300, 1500, 1800 en 2000mm
- geleverd zonder haken en gereedschapshouders

Order nr.	Orig. nr.	Gewicht kg	Afmetingen (l x b x h) mm	Prijs €
761001995	HE14510CBL	9,56	1000 x 800 x 25	115,00
761001996	HE14513CBL	12,00	1300 x 800 x 25	135,00
761001997	HE14515CBL	13,20	1500 x 800 x 25	144,00
761001998	HE14518CBL	16,50	1800 x 800 x 25	162,00
761001999	HE14520CBL	19,10	2000 x 800 x 25	183,00

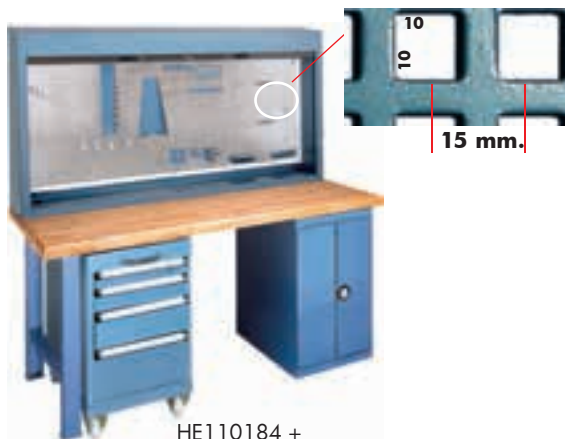

HE110184 +
HE13618M11 + HE1350



Wandkast met geperforeerde achterwand met afsluitbaar rolgordijn in metaalplaat. Perforatie met 10/10mm vierkant profiel. Staalplaatconstructie in blauwe hamerslagcoating.

- type extra plat
- diepte en hoogte 170/900mm
- leverbaar in breedte 1000, 1300, 1500, 1800 en 2000mm
- geleverd zonder haken en gereedschapshouders
- metalen rolgordijn met terugslagmechanisme
- afsluitbaar met sleutel

Order nr.	Orig. nr.	Gewicht kg	Afmetingen (l x b x h) mm	Prijs €
761000116	HE110104BL	36,50	1000 x 900 x 170	357,00
761000118	HE110134BL	51,00	1300 x 900 x 170	406,00
761000120	HE110154BL	64,80	1500 x 900 x 170	413,00
761000122	HE110184BL	66,50	1800 x 900 x 170	468,00
761000124	HE110204BL	72,00	2000 x 900 x 170	495,00

1.000



HE110104

accessoires vanaf p.529



HE145101



ook verkrijgbaar in gezeefdrukte afbeeldingen van gereedschappen (HE109 + HE110) zie www.vynckier.biz

1.300



HE110134



HE145131

1.500



HE110154



HE145151

1.800



HE110184



HE145181

2.000



HE110204



HE145201

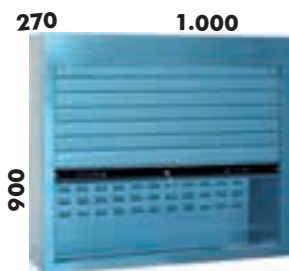

HE11010C

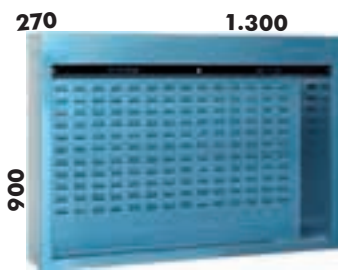

HE11013C

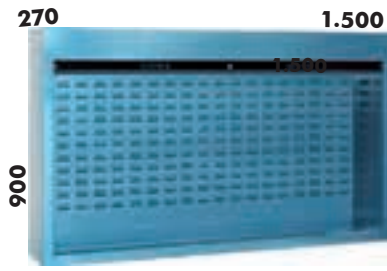

HE11015C



HE11010C1



HE11013C1

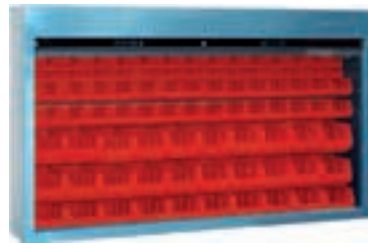

HE11015C1



HE11010C2



HE11013C2



HE11015C2

Wandkast met geperforeerde achterwand voor bakjes V-BULL 1, 2 en 3. Met afsluitbaar rolgordijn in metaalplaat. Perforatie met 10/10mm vierkant profiel. Staalplaatconstructie in blauwe hamerslagcoating.

- diepte en hoogte 270/900mm
- leverbaar in breedte 1000, 1300, 1500, 1800 en 2000mm
- metalen rolgordijn met terugslagmechanisme
- afsluitbaar met sleutel

Order nr.	Orig. nr.	Bakjes	Gewicht kg	Afmetingen (l x b x h) mm	Prijs €
761001841	HE11010CBL	-	31,00	1000 x 270 x 900	374,00
761001842	HE11010C1BL	18x0,4L+18x1,2L+18x3,5L	38,00	1000 x 270 x 900	476,00
761001843	HE11010C2BL	22x0,4L+18x1,2L+18x3,5L	38,00	1000 x 270 x 900	479,00
761001844	HE11013CBL	-	38,50	1300 x 270 x 900	427,00
761001845	HE11013C1BL	24x0,4L+24x1,2L+24x3,5L	48,00	1300 x 270 x 900	565,00
761001846	HE11013C2BL	22x0,4L+36x1,2L+20x3,5L	48,00	1300 x 270 x 900	569,00
761001847	HE11015CBL	-	43,00	1500 x 270 x 900	439,00
761001848	HE11015C1BL	28x0,4L+28x1,2L+30x3,5L	54,00	1500 x 270 x 900	605,00
761001849	HE11015C2BL	33x0,4L+30x1,2L+26x3,5L	53,50	1500 x 270 x 900	595,00
761001850	HE11018CBL	-	50,00	1800 x 270 x 900	499,00
761001851	HE11018C1BL	34x0,4L+34x1,2L+36x3,5L	63,00	1800 x 270 x 900	699,00
761001852	HE11018C2BL	33x0,4L+42x1,2L+32x3,5L	63,00	1800 x 270 x 900	695,00
761001853	HE11020CBL	-	53,00	2000 x 270 x 900	509,00
761001854	HE11020C1BL	38x0,4L+38x1,2L+39x3,5L	68,00	2000 x 270 x 900	725,00
761001855	HE11020C2BL	33x0,4L+36x1,2L+41x3,5L	68,00	2000 x 270 x 900	729,00

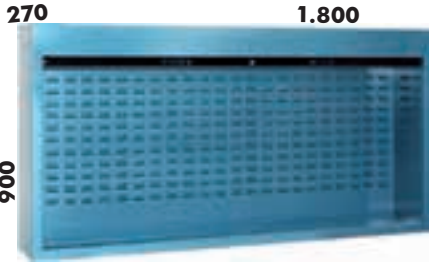

HE11018C

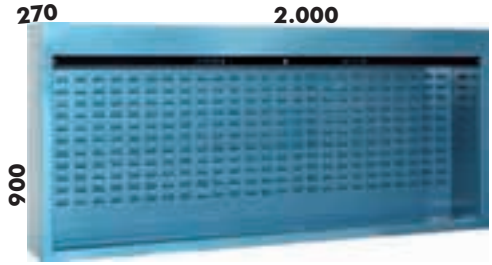

HE11020C

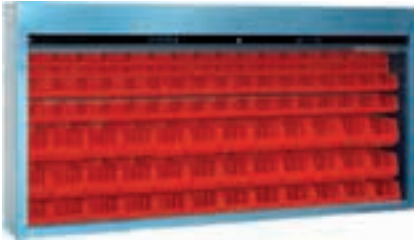

HE11018C1



HE11020C1

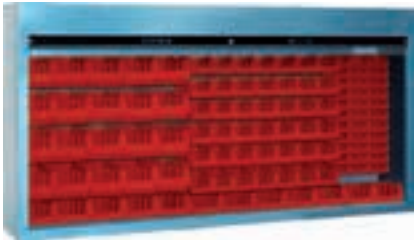

HE11018C2

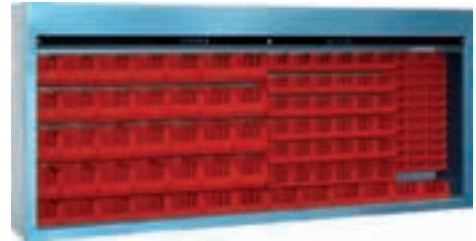

HE11020C2

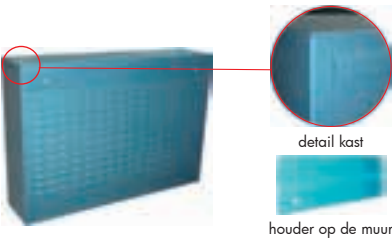

houder op de muur

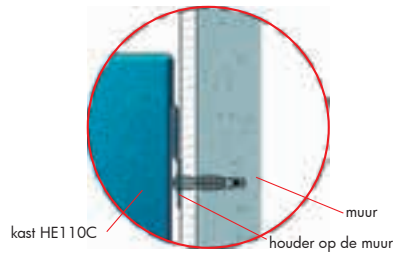

kast HE110C

houder op de muur

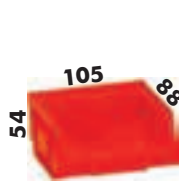

HEV-BULL1



HEV-BULL2



HEV-BULL3

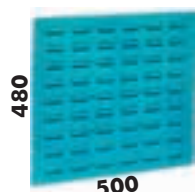

480

500

HEV-640H1

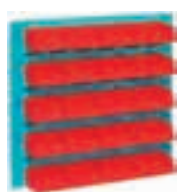

HEV-640H120



HEV-640H112



HEV-640H109



HEV-640H115

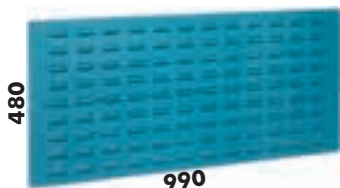

480

990

HEV-640H2

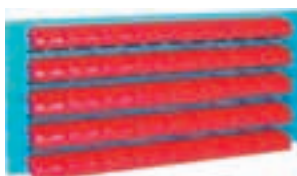

HEV-640H240



HEV-640H232



HEV-640H218



HEV-640H230



980

500

HEV-640H3



HEV-640H340

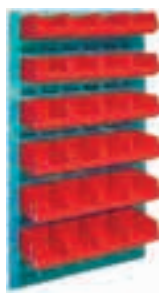

HEV-640H324



HEV-640H318



HEV-640H327

Metalen wandpaneel type V-640H voor bakjes V-BULL 1, 2 en 3. Staalplaat 12/10mm.

Order nr.	Orig. nr.	Bakjes	Diepte mm	Gewicht kg	Afmetingen (l x b x h) mm	Prijs €
761001808	HEV-640H1BL	-	-	3,00	500 x 480 x 0	29,50
761001812	HEV-640H120BL	20x0,4L	100	3,92	500 x 480 x 0	46,50
761001810	HEV-640H112BL	12x1,2L	180	4,40	500 x 480 x 0	50,50
761001809	HEV-640H109BL	9x3,5L	250	5,10	500 x 480 x 0	61,00
761001811	HEV-640H115BL	8x0,4L+4x1,2L+3x3,5L	250	4,50	500 x 480 x 0	55,00
761001813	HEV-640H2BL	-	-	10,00	990 x 480 x 0	45,00
761001817	HEV-640H240BL	40x0,4L	100	7,00	990 x 480 x 0	72,00
761001816	HEV-640H232BL	32x1,2L	180	9,00	990 x 480 x 0	96,00
761001814	HEV-640H218BL	18x3,5L	250	9,50	990 x 480 x 0	108,00
761001815	HEV-640H230BL	8x0,4L+16x1,2L+6x3,5L	250	9,00	990 x 480 x 0	98,00
761001818	HEV-640H3BL	-	-	10,00	500 x 980 x 0	46,50
761001822	HEV-640H340BL	40x0,4L	100	7,00	500 x 980 x 0	74,00
761001820	HEV-640H324BL	24x1,2L	180	8,00	500 x 980 x 0	83,50
761001819	HEV-640H318BL	18x3,5L	250	9,50	500 x 980 x 0	110,00
761001821	HEV-640H327BL	12x0,4L+12x1,2L+3x3,5L	250	8,00	500 x 980 x 0	83,50

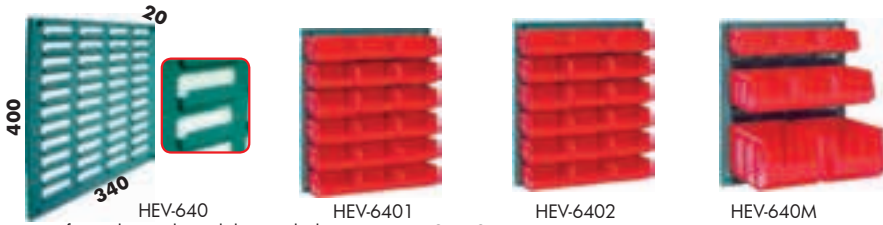

Kunststof wandpaneel geschikt voor bakjes V-BULL 1, 2 en 3.

Order nr.	Orig. nr.	Bakjes	Gewicht kg	Afmetingen (l x b x h) mm	Prijs €
761001805	HEV-640	-	0,20	340 x 20 x 400	9,00
761001806	HEV-6401	18x0,4L	1,10	340 x 20 x 400	23,50
761001807	HEV-6402	12x1,2L	1,50	340 x 20 x 400	30,50
761001823	HEV-640MBL	3x0,4L+3x1,2L+2x3,5L	1,20	340 x 20 x 400	27,00



Wandpaneel voor opbergbakjes HEV-FOX 101, 102, 103 en 104.

Order nr.	Orig. nr.	Bakjes	Gewicht kg	Afmetingen (l x b x h) mm	Prijs €
761001783	HEV-401BL	-	11,50	603 x 560 x 0	46,50
761001784	HEV-401H1BL	24	12,43	603 x 560 x 0	175,00
761001785	HEV-401H2BL	22	26,26	603 x 560 x 0	162,00
761001786	HEV-401H3BL	22	11,96	603 x 560 x 0	167,00
761001787	HEV-401H4BL	45	11,19	603 x 560 x 0	164,00
761001788	HEV-401H5BL	63	10,55	603 x 560 x 0	160,00
761001789	HEV-401H6BL	22	12,86	603 x 560 x 0	183,00

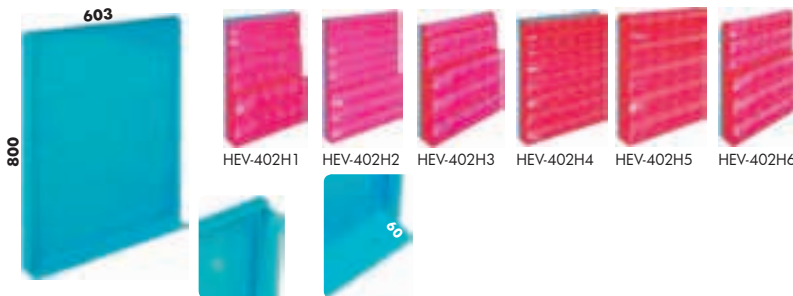

Wandpaneel voor opbergbakjes HEV-FOX 101, 102, 103 en 104.

Order nr.	Orig. nr.	Bakjes	Gewicht kg	Afmetingen (l x b x h) mm	Prijs €
761001790	HEV-402BL	-	14,50	603 x 800 x 0	56,00
761001791	HEV-402H1BL	49	15,21	603 x 800 x 0	227,00
761001792	HEV-402H2BL	72	14,46	603 x 800 x 0	224,00
761001793	HEV-402H3BL	36	15,81	603 x 800 x 0	233,00
761001794	HEV-402H4BL	42	14,86	603 x 800 x 0	218,00
761001795	HEV-402H5BL	25	16,80	603 x 800 x 0	246,00
761001796	HEV-402H6BL	33	16,24	603 x 800 x 0	217,00



HEV-BULL1

HEV-BULL2

HEV-BULL3

Opbergbakjes.

Order nr.	761003495	761003496	761003497
Orig. nr.	HEV-BULL1	HEV-BULL2	HEV-BULL3
Volume	0,40	1,20	3,50
Capaciteit (op perfwand)	kg	10,00	15,00
Gewicht	kg	0,11	0,23
Afmetingen (l x b x h)	mm	105 x 88 x 54	144 x 237 x 123
Prijs	€	0,90	2,10
			4,45

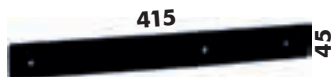

HEV-940



HEV-9401



HEV-9402



HEV-9403

Kunststof steun, type geschikt voor opbergbakjes V-BULL 1, 2 en 3.

Order nr.	Orig. nr.	Bakjes	Gewicht kg	Afmetingen (l x b x h) mm	Prijs €
761003465	HEV-940	-	0,01	415 x 45 x 0	3,40
761003466	HEV-9401	4x0,4L	0,01	415 x 45 x 0	8,20
761003467	HEV-9402	4x1,2L	0,01	415 x 45 x 0	12,50
761003468	HEV-9403	3x3,5L	0,01	415 x 45 x 0	24,50



HE110019



HE110020

Opbergbakjes met houder voor wandpanelen HE144, HE109 en HE110 (hout).

Order nr.	Orig. nr.	Gewicht kg	Prijs €
761000112	HE110019BL	0,54	27,00
761000113	HE110020BL	0,11	11,50

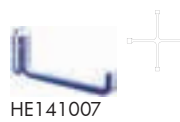

Verpakking van 5 haken 45° voor wandpanelen HE110, HE141 en HE145.

Order nr.	Orig. nr.	Aantal stuks	Lengte mm	Gewicht kg	Prijs €
761001065	HE141001	5	20	0,12	8,10
761001066	HE141002	5	40	0,13	8,10
761001067	HE141003	5	65	0,15	9,00
761001068	HE141004	5	90	0,17	10,50
761001069	HE141005	5	20	0,11	9,00
761001070	HE141006	5	40	0,13	9,00
761001071	HE141007	5	65	0,14	10,50
761001072	HE141008	5	90	0,16	10,50

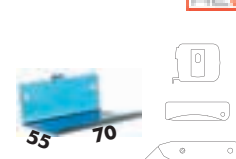

Gereedschapsteunen voor wandpanelen HE110, HE141 en HE145.

Order nr.	Orig. nr.	Aantal stuks	Gewicht kg	Prijs €
761001073	HE141009BL	1	0,42	11,50
761001074	HE141010BL	1	0,42	14,50
761001077	HE141013BL	1	0,06	4,95



Opbergbakjes met houder voor wandpanelen HE110, HE141 en HE145.

Order nr.	Orig. nr.	Gewicht kg	Prijs €
761001075	HE141011BL	0,12	13,50
761001090	HE141026BL	0,54	24,50



HE141022

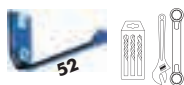

HE144001



HE144002



HE141012



HE141014

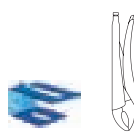

HE141015



HE141016



HE141017

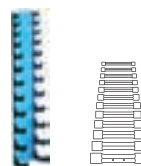

HE141018

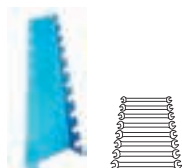

HE141019

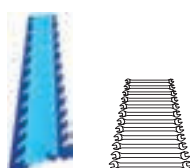

HE141020

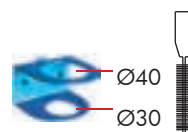

HE141021

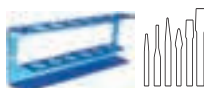

HE141023

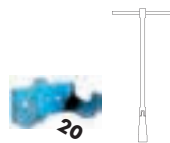

HE141024

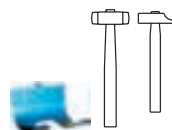

HE141025

Gereedschapssteunen voor wandpanelen HE110, HE141 en HE145.

Order nr.	Orig. nr.	Aantal stuks	Gewicht kg	Prijs €
761001097	HE144001BL	5	0,08	15,90
761001098	HE144002BL	5	0,09	10,50
761001076	HE141012BL	1	0,14	6,50
761001078	HE141014BL	1	0,20	6,70
761001079	HE141015BL	1	0,08	5,30
761001080	HE141016BL	1	0,06	5,60
761001081	HE141017BL	1	0,10	6,00
761001085	HE141021BL	1	0,07	5,10
761001086	HE141022BL	1	0,11	6,70
761001087	HE141023BL	1	0,15	5,60
761001088	HE141024BL	1	0,04	9,00
761001089	HE141025BL	2	0,13	5,60



HE145101



HE145131



HE145151



HE145181



HE145201

Ophangset voor wandpanelen HE110, HE141 en HE145.

Order nr.	Orig. nr.	Aantal stuks	Gewicht kg	Prijs €
761001107	HE145101BL	17	2,50	57,50
761001110	HE145131BL	21	3,00	58,50
761001112	HE145151BL	27	3,20	66,00
761001114	HE145181BL	35	3,50	70,00
761001116	HE145201BL	43	4,00	71,00



toepassingen



steun: HE11215SL
werkbank: HE13615D1



paneel: HE14520
steun: HE11220SL
werkbank: HE11220

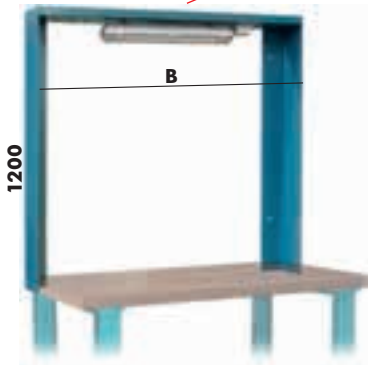

Steun met fluorescerende lamp.

Order nr.	Orig. nr.	Breedte mm	Vermogen W	Gewicht kg	Prijs €
761003561	HE11210SLBL	1000	1x18	1,00	332,00
761003562	HE11213SLBL	1300	1x18	1,00	337,00
761003563	HE11215SLBL	1500	1x36	1,00	387,00
761003564	HE11218SLBL	1800	1x58	1,00	410,00
761003565	HE11220SLBL	2000	1x58	1,00	415,00

HECO



HE 110 001



HE 110 002



HE 110 003



HE 110 004

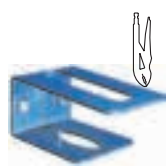

HE 110 005



HE 110 006

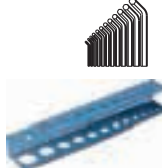



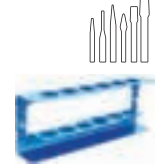





HE 110 007



HE 110 014

Gereedschapssteunen voor wandpanelen HE144, HE109 en HE110 (hout).

Order nr.	Orig. nr.	Aantal stuks	Gewicht kg	Prijs €
76100094 	HE110001BL	1	0,14	4,87
76100095 	HE110002BL	1	0,31	14,50
76100096 	HE110003BL	1	0,12	5,10
76100097 	HE110004BL	1	0,20	5,30
76100098 	HE110005BL	1	0,07	3,80
76100099 	HE110006BL	1	0,05	3,92
761000100 	HE110007BL	1	0,11	4,97
761000107 	HE110014BL	1	0,15	4,95

EQUIPMENT

HECO



HE110008



HE110009







HE110010



HE110011

Gereedschapssteunen voor wandpanelen HE144, HE109 en HE110 (hout)

Order nr.	Orig. nr.	Aantal stuks	Gewicht kg	Prijs €
761000101 	HE110008BL	2	0,12	5,60
761000102 	HE110009BL	1	0,44	11,50
761000103 	HE110010BL	1	0,30	13,50
761000104 	HE110011BL	1	0,45	12,90

HECO



HE110012



HE110013



HE110015



HE110016



HE110017









HE110018



HE110021

Gereedschapssteunen voor wandpanelen HE144, HE109 en HE110 (hout). HE110021 niet geschikt voor HE144.

Order nr.	Orig. nr.	Aantal stuks	Gewicht kg	Prijs €
761000105 	HE110012BL	1	0,08	4,45
761000106 	HE110013BL	1	0,11	3,80
761000108 	HE110015BL	1	0,06	4,95
761000109 	HE110016BL	1	0,04	4,70
761000110 	HE110017BL	2	0,06	5,30
761000111 	HE110018BL	1	0,03	7,00
761000114 	HE110021BL	2	0,05	4,90



HEV-CONT50H
 Paneel met rubberwielen voor bakjes V-BULL 1, 2 en 3.

HEV-CONT50H1 HEV-CONT50H2 HEV-CONT50H3

Order nr.	Orig. nr.	Aantal bakjes	Gewicht kg	Afmetingen (l x b x h) mm	Prijs €
761001824	HEV-CONT50HBL	-	35,00	1000 x 1500 x 0	419,00
761001825	HEV-CONT50H1BL	16 x V-BULL1 - 32 x V-BULL2 - 36 x V-BULL3	65,70	1000 x 1500 x 0	615,00
761001826	HEV-CONT50H2BL	32 x V-BULL1 - 16 x V-BULL2 - 36 x V-BULL3	62,70	1000 x 1500 x 0	599,00
761001827	HEV-CONT50H3BL	48 x V-BULL2 - 36 x V-BULL3	71,10	1000 x 1500 x 0	625,00

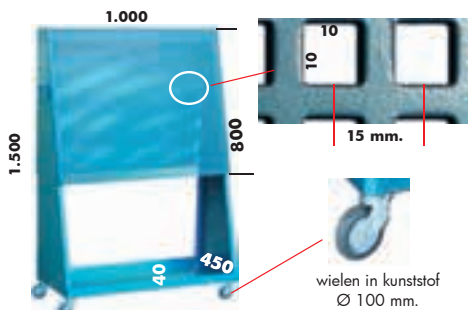

Geperforeerd paneel met rubberwielen.

Order nr.	Orig. nr.	Gewicht kg	Afmetingen (l x b x h) mm	Prijs €
761001108	HE14510RBL	33,00	1000 x 1500 x 0	443,00

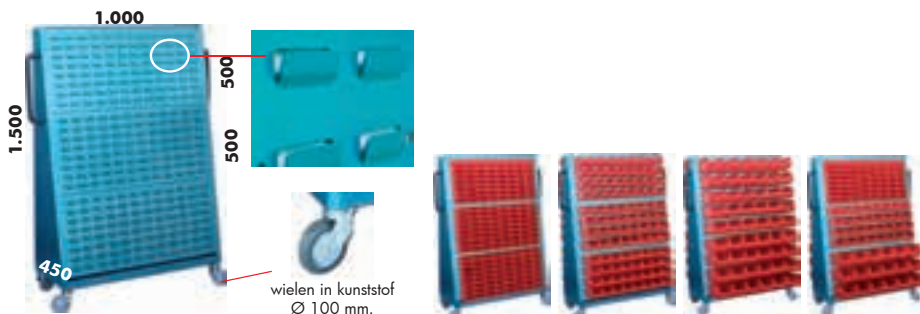

HEV-CONT45H
 Paneel met wielen voor bakjes V-BULL 1, 2 en 3.

HEV-CONT45H1 HEV-CONT45H1 HEV-CONT45H3 HEV-CONT45H4

Order nr.	Orig. nr.	Aantal bakjes	Gewicht kg	Afmetingen (l x b x h) mm	Prijs €
761003507	HEV-CONT45HBL	-	53,50	1000 x 1500 x 0	494,00
761003508	HEV-CONT45H1BL	384	71,50	1000 x 1500 x 0	779,00
761003509	HEV-CONT45H2BL	192	75,20	1000 x 1500 x 0	789,00
761003510	HEV-CONT45H3BL	108	78,00	1000 x 1500 x 0	855,00
761003511	HEV-CONT45H4BL	228	75,00	1000 x 1500 x 0	805,00



Metalworks werkbanken

METALWORKS



Volledig metalen werkbank.

- met standaard voeten
- bovenblad in 3mm staalplaat en afgeronde hoeken
- stevig onderstel met metalen legplaat
- met 2 of 3 gelagerde laden, individueel afsluitbaar
- rood gepoederlakt

Order nr.		751001501 ^E	751002001 ^E
Orig. nr.		DER1500A	DER2000A
Maximum belastbare capaciteit	kg	500	400
Werkblad		metaal	metaal
Gewicht	kg	75,00	91,00
Afmetingen (l x b x h)	mm	1500 x 640 x 860	2000 x 640 x 860
Prijs	€	339,00	349,00

METALWORKS



Volledig metalen werkbank.

- met standaard voeten
- bovenblad in 3mm staalplaat en afgeronde hoeken
- stevig onderstel met metalen legplaat
- met 2 of 3 gelagerde laden, individueel afsluitbaar
- rood gepoederlakt

Order nr.		751001500 ^E	751002000 ^E
Orig. nr.		DER1500	DER2000
Maximum belastbare capaciteit	kg	500	400
Werkblad		metaal	metaal
Laden		2	3
Gewicht	kg	83,00	103,00
Afmetingen (l x b x h)	mm	1500 x 640 x 860	2000 x 640 x 860
Prijs	€	359,00	369,00



DER2000P

Volledig metalen werkbank met in hoogte verstelbare voeten.

- standaard met in de hoogte verstelbare voeten 876-916-956-996
- bovenblad in 3mm staalplaat en afgeronde hoeken
- stevig onderstel met metalen legplaat
- met 2 of 3 gelagerde laden, individueel afsluitbaar
- rood gepoederlakt

Order nr.		751001506 ^E	751002021 ^E
Orig. nr.		DER1500P	DER2000P
Maximum belastbare capaciteit	kg	400	300
Werkblad		metaal	metaal
Verstelbare voeten		✓	✓
Laden		2	3
Gewicht	kg	83,00	103,00
Afmetingen (l x b x h)	mm	1500 x 640 x 996	2000 x 640 x 996
Prijs	€	359,00	369,00



DER2000PW

Volledig metalen werkbank met in hoogte verstelbare voeten en MDF bovenblad.

- standaard met in de hoogte verstelbare voeten 894-934-974-1013
- bovenblad in 3mm staalplaat en afgeronde hoeken + bovenop een MDF werkblad
- stevig onderstel met metalen legplaat
- met 2 of 3 gelagerde laden, individueel afsluitbaar
- rood gepoederlakt

Order nr.		751001507 ^E	751002022 ^E
Orig. nr.		DER1500PW	DER2000PW
Maximum belastbare capaciteit	kg	400	300
Werkblad		MDF	MDF
Verstelbare voeten		✓	✓
Laden		2	3
Gewicht	kg	103,00	123,00
Afmetingen (l x b x h)	mm	1500 x 640 x 1013	2000 x 640 x 996
Prijs	€	389,00	379,00

METALWORKS



DER2000W



Volledig metalen werkbank met MDF bovenblad.

- met standaard voeten
- bovenblad in 3mm staalplaat en afgeronde hoeken + bovenop MDF werkblad
- stevig onderstel met metalen legplaat
- met 2 gelagerde laden, individueel afsluitbaar
- rood gepoederlakt

Order nr.	751001503 ^E	751002004 ^E
Orig. nr.	DER1500W	DER2000W
Type meubel	werkbank	werkbank
Maximum belastbare capaciteit	kg 500	400
Werkblad	MDF	MDF
Laden	2	3
Gewicht	kg 103,00	123,00
Afmetingen (l x b x h)	mm 1500 x 640 x 1035	2000 x 640 x 1053
Prijs	€ 389,00	379,00

METALWORKS



DER1500R

DER2000R



Volledig metalen werkbank.

- met standaard voeten
- bovenblad in 3mm staalplaat en afgeronde hoeken
- stevig onderstel met metalen legplaat
- met 2 of 3 gelagerde laden, individueel afsluitbaar
- rood gepoederlakt

Order nr.	751001504 ^E	751002008 ^E
Orig. nr.	DER1500R	DER2000R
Type meubel	werktafel	werktafel
Maximum belastbare capaciteit	kg 500	400
Werkblad	metaal	metaal
Laden	2	3
Wielen	✓	✓
Gewicht	kg 88,00	108,00
Afmetingen (l x b x h)	mm 1500 x 640 x 1035	2000 x 640 x 1035
Prijs	€ 439,00	449,00



Volledig metalen werkbank met MDF bovenblad.

- met standaard voeten
- bovenblad in 3mm staalplaat en afgeronde hoeken + bovenop MDF werkblad
- stevig onderstel met metalen legplaat
- met 2 of 3 gelagerde laden, individueel afsluitbaar
- rood gepoederlakt

Order nr.		751001505	751002009
Orig. nr.		DER1500WR	DER2000WR
Type meubel		werkbank	werkbank
Maximum belastbare capaciteit	kg	500	400
Werkblad		MDF	MDF
Laden		2	3
Wielen		✓	✓
Gewicht	kg	108,00	128,00
Afmetingen (l x b x h)	mm	1500 x 640 x 1053	2000 x 640 x 1053
Prijs	€	459,00	469,00



Metalen werktafel compleet met perfo-wandplaat. Kan op zichzelf worden geplaatst zonder muurbevestiging. Geleverd zonder haken of gereedschap. Model DER2017M en DER2017PM geleverd met 18mm MDF-werkblad.

Order nr.		751002017	751002019	751002018	751002020
Orig. nr.		DER2017	DER2017P	DER2017M	DER2017PM
Maximum belastbare capaciteit	kg	400	400	400	-
Werkblad		metaal	metaal	MDF	MDF
Verstelbare voeten		x	✓	x	✓
Laden		3	3	3	3
Perfopaneel		2000x830	2000x830	2000x830	2000x830
Afmetingen lade (1)	mm	510x120 (3x)	510x120 (3x)	510x120 (3x)	510x120 (3x)
Gewicht	kg	128,00	128,00	140,00	140,00
Afmetingen (l x b x h)	mm	2000 x 640 x 860	2000 x 640 x 996	2000 x 640 x 860	2000 x 640 x 1013
Prijs	€	699,00	765,00	729,00	795,00

Stel zelf uw werktafel samen dankzij dit modulair concept.
 - metalen voeten instelbaar in de hoogte (810-1180mm).
 - altijd de meest ergonomische houding.
 - tafels met een stevig multiplex werkblad 30mm

- rood en grijs gepoederlakt
 - elementen worden los geleverd met bevestigingsmateriaal
 - de werkbanken zijn belastbaar tot 800kg

METALWORK®

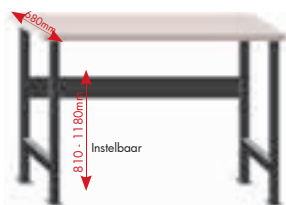

Order nr.	856001370 €	
Orig. nr.	MOD120	
Maximum belastbare capaciteit	kg	800
Werkblad	multiplex 30mm	
Verstelbare voeten	✓	
Gewicht	kg	50,00
Afmetingen (l x b x h)	mm	1200 x 680 x 1180
Prijs	€ 285,00	

METALWORK®

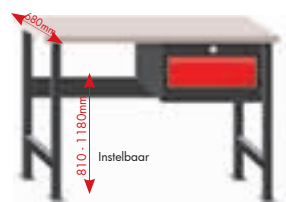

Order nr.	856001374 €	
Orig. nr.	MOD124	
Laden	1	
Maximum belastbare capaciteit	kg	800
Werkblad	multiplex 30mm	
Verstelbare voeten	✓	
Afmetingen ladeblok	mm	572x525x810
Afmetingen lade (1)	mm	510x168
Gewicht	kg	50,00
Afmetingen (l x b x h)	mm	1200 x 680 x 1180
Prijs	€ 379,00	

METALWORK®

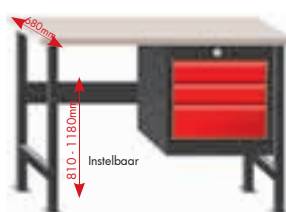

Order nr.	856001375 €	
Orig. nr.	MOD125	
Laden	3	
Maximum belastbare capaciteit	kg	800
Werkblad	multiplex 30mm	
Verstelbare voeten	✓	
Afmetingen ladeblok	mm	572x525x470
Afmetingen lade (1)	mm	510x90 (2x)
Afmetingen lade (2)	mm	510x168 (1x)
Gewicht	kg	50,00
Afmetingen (l x b x h)	mm	1200 x 680 x 1180
Prijs	€ 449,00	

METALWORK®



Order nr.	856001371 €	
Orig. nr.	MOD121	
Laden	5	
Maximum belastbare capaciteit	kg	800
Werkblad	multiplex 30mm	
Afmetingen ladeblok	mm	572x525x870
Afmetingen lade (1)	mm	510x90 (3x)
Afmetingen lade (2)	mm	510x168 (2x)
Gewicht	kg	50,00
Afmetingen (l x b x h)	mm	1200 x 680 x 810
Prijs	€ 475,00	

METALWORK®



Order nr.	856001360 €	
Orig. nr.	MOD200	
Maximum belastbare capaciteit	kg	800
Werkblad	multiplex 30mm	
Verstelbare voeten	✓	
Gewicht	kg	50,00
Afmetingen (l x b x h)	mm	2000 x 680 x 1180
Prijs	€ 319,00	

METALWORK®



Order nr.	856001364 €	
Orig. nr.	MOD204	
Laden	1	
Maximum belastbare capaciteit	kg	800
Werkblad	multiplex 30mm	
Verstelbare voeten	✓	
Afmetingen ladeblok	mm	572x525x810 (2x)
Afmetingen lade (1)	mm	510x168
Gewicht	kg	50,00
Afmetingen (l x b x h)	mm	2000 x 680 x 1180
Prijs	€ 429,00	



METALWORKS



Order nr.	856001365 E	
Orig. nr.	MOD205	
Laden	3	
Maximum belastbare capaciteit	kg	800
Werkblad	multiplex 30mm	
Verstelbare voeten	✓	
Afmetingen ladeblok	mm	572x525x470
Afmetingen lade (1)	mm	510x90 (2x)
Afmetingen lade (2)	mm	510x168 (1x)
Gewicht	kg	50,00
Afmetingen (l x b x h)	mm	2000 x 680 x 1180
Prijs	€	505,00

METALWORKS



Order nr.	856001361 E	
Orig. nr.	MOD201	
Laden	5	
Maximum belastbare capaciteit	kg	800
Werkblad	multiplex 30mm	
Afmetingen ladeblok	mm	572x525x810
Afmetingen lade (1)	mm	510x90 (3x)
Afmetingen lade (2)	mm	510x168 (2x)
Gewicht	kg	50,00
Afmetingen (l x b x h)	mm	2000 x 680 x 810
Prijs	€	515,00

METALWORKS



Order nr.	856001366 E	
Orig. nr.	MOD206	
Laden	2x5	
Maximum belastbare capaciteit	kg	800
Werkblad	multiplex 30mm	
Afmetingen ladeblok	mm	572x525x810 (2x)
Afmetingen lade (1)	mm	510x90 (3x)
Afmetingen lade (2)	mm	510x168 (2x)
Gewicht	kg	50,00
Afmetingen (l x b x h)	mm	2000 x 680 x 810
Prijs	€	719,00

METALWORKS



Order nr.	856001367 E	
Orig. nr.	MOD207	
Laden	2x5 + 4	
Maximum belastbare capaciteit	kg	800
Werkblad	multiplex 30mm	
Afmetingen ladeblok	mm	572x525x810 (2x)
Afmetingen lade (1)	mm	510x90 (8x)
Afmetingen lade (2)	mm	510x168 (6x)
Gewicht	kg	50,00
Afmetingen (l x b x h)	mm	2000 x 680 x 810
Prijs	€	955,00

METALWORKS



Rubber fijnribloper geschikt voor gebruik met MODULAR werkbanken. Ideaal voor werkzaamheden in garages of smidse.

Order nr.	751988124 E	751988125 E
Orig. nr.	FRSM1200-MOD120	FRSM2000-MOD200
Lengte	mm 1200	2000
Breedte	mm 680	680
Gewicht	kg 1,00	1,00
Prijs	€ 18,50	24,50

METALWORKS



Stabiele, opklapbare werkbank met watervast bovenblad in multiplex. Gemakkelijk opklappen en opbergen, ideaal voor gebruik op de werf of kleine werkuimtes.

Order nr.	713900030 E	
Orig. nr.	DETW10070	
Type meubel	tafel	
Maximum belastbare capaciteit	kg	250
Werkblad	multiplex	
Plooibaar	✓	
Gewicht	kg	36,00
Afmetingen (l x b x h)	mm	1000 x 700 x 830
Prijs	€	164,00



Metalworks wandpanelen & wandkasten

METALWORKS



Metalen geperforeerde wandplaat (zonder gereedschap noch haken geleverd). Tussenafstand perforatie 8mm, diameter perforatie 5mm.

Order nr.	751501102 €	
Orig. nr.	DERGR17	
Lengte	mm	2000
Hoogte	mm	830
Gewicht	kg	13,00
Prijs	€	154,00

METALWORKS

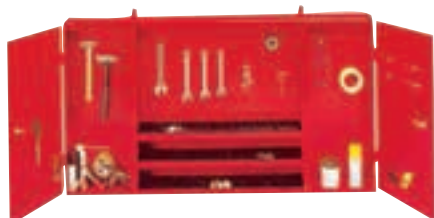

Volledig metalen muurkast met geperforeerde wandplaat. 2 afsluitbare deuren, bakjes inbegrepen. Rood gepoederlakt (zonder gereedschap noch haken geleverd).

Order nr.	758412002 €	
Orig. nr.	DERK2000	
Lengte	mm	2000
Breedte	mm	150
Hoogte	mm	830
Aantal kasten		2
Gewicht	kg	57,00
Prijs	€	444,00

METALWORKS



Stalen verchroomde haken voor de geperforeerde wandplaten voor DERGR17, DERK2000.

Order nr.	Orig. nr.	Omschrijving	Prijs €
751600010 €	DERR10	Ronde haak	1,50
751607000 €	DERH70	Rechte haak L. 70mm	1,50
751601000 €	DERH100	Rechte haak L. 100mm	1,65



METALWORKS

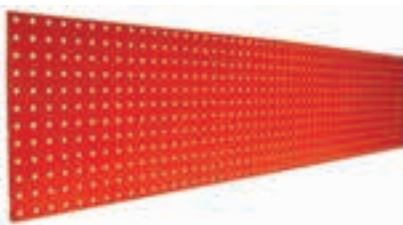

Perfopaneel.

Order nr.	856001327 €	856001342 €
Orig. nr.	MODP1200	MODP2000
Breedte	mm 1200	2000
Hoogte	mm 460	460
Diepte	mm 20	20
Perforatie	mm 10x10	10x10
Hart-op-hart afstand	mm 38x38	38x38
Gewicht	kg 6,00	9,50
Prijs	€ 57,00	112,00

METALWORKS



Muurkast met geperforeerde achterwand en 2 afsluitbare deuren. 4 liggers. Voorzien om op de muur of op de optionele houders te monteren.

Order nr.	856001326 €	856001351 €
Orig. nr.	MODM1200	MODM1850
Lengte	mm 1200	1950
Breedte	mm 200	200
Hoogte	mm 600	600
Gewicht	kg 50,00	42,00
Prijs	€ 184,00	234,00

METALWORKS

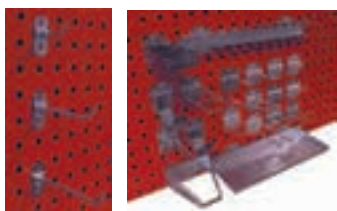

a
b
Haken en werktuigklemmen voor perforaneel
MODP1200/2000, MODM1200/1850, GW107/115.

Order nr.	856001504 €	856001505 €
Orig. nr.	MOD23105	MOD23115
Type	a	a
Omschrijving	haak 45° 50mm	haak 45° 100mm
Gewicht	kg 1,00	1,00
VE	1	1
Min. bestelhoeveelheid	5	5
Prijs	€ 1,20	1,20

Order nr.	856001507 €	856001551 €
Orig. nr.	MOD23117	MOD23201
Type	a	b
Omschrijving	haak 45° 200mm	45-delige hakenset Modular
Gewicht	kg 1,00	1,00
VE	1	1
Min. bestelhoeveelheid	5	1
Prijs	€ 1,60	59,90

METALWORKS



Houders muurkast voor het monteren van muurkast
MODM1200/1850 op werkbank MODULAR.

Order nr.	856001328 €
Orig. nr.	MODMHK
Gewicht	kg 50,00
Prijs	€ 39,00

METALWORKS



Metalen bakjesrek met 30 plastic bakjes.

Order nr.	751500580 €
Orig. nr.	DERB580
Type meubel	bakjesrek
Materie	metaal
Afmetingen per compartiment (l x b x h)	mm 13.3x11.2x3.8
Aantal bakjes	30
Gewicht	kg 15,00
Afmetingen (l x b x h)	mm 685 x 135 x 580
Prijs	€ 104,00

Bankvijzen

METALWORKS



NEW

Professionele stalen bankschroef. Onbreekbaar. Industriële kwaliteit. Gietstalen constructie. Met 360° draaibare basis, gehard aambeeld en pijpbecken. Met schroeven om de geleiding aan te passen.

Order nr.	Orig. nr.	Span-wijde mm	Bek-hoogte mm	Gewicht kg	Prijs €
909061000 Ⓡ	BAP100	100	130	7,50	69,00
909061250 Ⓡ	BAP125	125	155	11,00	99,00
909061500 Ⓡ	BAP150	150	180	14,50	129,00
909061750 Ⓡ	BAP175	175	210	14,50	179,00

METALWORKS



Stalen bankschroef. Onbreekbaar. Industriële kwaliteit. Gietstalen constructie in staal SC37. Met 360° draaibare basis, gehard aambeeld en pijpbecken. Zwarte warmverlakte afwerking.

Order nr.	Orig. nr.	Span-wijde mm	Bek-hoogte mm	Gewicht kg	Prijs €
909070750 Ⓡ	BAGSY3	75	50	6,00	57,00
909071000 Ⓡ	BAGSY4	100	60	7,50	59,00
909071250 Ⓡ	BAGSY5	125	70	11,00	79,00
909071500 Ⓡ	BAGSY6	150	75	14,50	99,00
909072000 Ⓡ	BAGSY8	200	90	20,50	139,00
909072500 Ⓡ	BAGSY10	200	100	25,60	224,00

METALWORKS



Vervangbek voor BAGSY.

Order nr.	Orig. nr.	Voor type	Gewicht kg	Prijs €
909075143 Ⓡ	BAGSY4J	BAGSY4	0,30	7,10
909075144 Ⓡ	BAGSY5J	BAGSY5	0,35	17,50
909075145 Ⓡ	BAGSY6J	BAGSY6	0,39	16,50
909075146 Ⓡ	BAGSY8J	BAGSY8	0,39	18,90
909075147 Ⓡ	BAGSY10J	BAGSY10	0,50	23,90

METALWORKS



Set zachte aluminium klauwen. Met magnetische strip voor het vasthechten op becken. Geschikt voor elke klassieke bankschroef.

Order nr.	909079150 €	909079100 Ⓡ	909079125 Ⓡ
Orig. nr.	MGNALU150	MGNALU100	MGNALU125
Lengte	150mm	100mm	125mm
Gewicht	kg 0,21	0,21	0,21
Prijs	€ 8,60	6,90	7,60

Metalworks ladenkasten

METALWORKS



Volledig gelaste metalen ladenkast.

- stevige gelagerde laden
- maximum opening laden : 85% of 55cm
- rood gepoederlakt
- centrale sluiting
- mogelijkheid van opdeling van de laden
- met rubber beschermingstop op het bovenblad

Order nr.	751501203
Orig. nr.	DERLK7
Werkblad	rubber
Materie	metaal
Laden	7
Afmetingen lade (1)	mm 610x645x50 (2x)
Afmetingen lade (2)	mm 610x645x117 (3x)
Afmetingen lade (3)	mm 610x645x140 (2x)
Slot	sleutel
Gewicht	kg 103,00
Afmetingen (l x b x h)	mm 715 x 725 x 980
Prijs	€ 579,00

Order nr.	751501210
Orig. nr.	DERLK10S
Werkblad	rubber
Materie	metaal
Laden	10
Afmetingen lade (1)	mm 610x645x50 (8x)
Afmetingen lade (2)	mm 610x645x117 (2x)
Afmetingen lade (3)	mm -
Slot	sleutel
Gewicht	kg 110,00
Afmetingen (l x b x h)	mm 715 x 725 x 980
Prijs	€ 739,00

METALWORKS

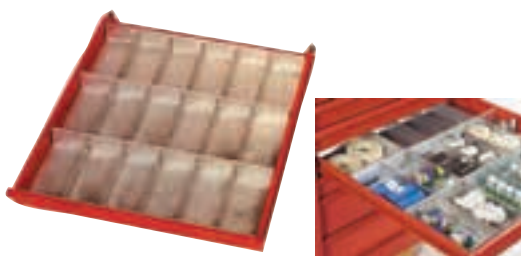

Compartmenteerset voor ladenkasten STAR DERLK. Bestaande uit 18 (3x6) gelijke onderverdelingen.

Order nr.	751501304
Orig. nr.	DERLK7S
Aantal compartimenten	18
Afmetingen per compartiment (l x b x h)	mm 200x100x45
Gewicht	kg 5,00
Afmetingen (l x b x h)	mm 600 x 600 x 45
Prijs	€ 48,00

METALWORKS



Handige materiaalark met 4 afsluitbare lades en een open opbergvak bovenaan. De lades zijn 100% uittrekbaar. Met rubber berschermmat bovenaan en 2 handgrepen. Rolgelagerde geleiders. Kan onder alle modular werkbanken worden gereden.

Order nr.	856001325
Orig. nr.	MODK440
Lengte	mm 440
Breedte	mm 530
Hoogte	mm 750
Gewicht	kg 35,00
Prijs	€ 297,00

METALWORKS



Ladeblok met 1, 3 of 5 lades. Met cilinderslot. De lades zijn 100% uittrekbaar. Rolgelagerde geleiders. Stevige stalen constructie uit 0,7 - 1,0 mm staalplaat. Inclusief tussenschotten (zie tabel).

Order nr.	856001345	856001346
Orig. nr.	MOD1L	MOD3L
Laden	1	3
Breedte	mm 572	572
Diepte	mm 525	525
Hoogte	255	470
Capaciteit	kg 50	50
Type	hangend	hangend
Gewicht	kg 50,00	36,00
Prijs	€ 134,00	214,00

Order nr.	856001347	856001392
Orig. nr.	MOD5L	MOD5LMP
Laden	5	5
Breedte	mm 572	572
Diepte	mm 525	525
Hoogte	810	837
Capaciteit	kg 50	50
Type	staand	staand met houten bovenblad
Gewicht	kg 50,00	30,00
Prijs	€ 349,00	389,00

METALWORKS



Ladeverdeling H. 62mm voor ladeblokken MOD1L/3L/5L.

Order nr.	856001350
Orig. nr.	MODIV62
Gewicht	kg 2,50
Prijs	€ 19,50

METALWORKS



Geleverd zonder gereedschappen

Spuitbushouder met magneet-bevestiging. Kan op elke metalen ondergrond worden bevestigd.

Order nr.	801105760
Orig. nr.	MAG3CAN
Gewicht	kg 1,19
Afmetingen (l x b x h)	mm 127 x 298 x 130
Prijs	€ 14,50

TENGOOLS



LED lamp AC/DC met magneet.

Order nr.	173420209
Orig. nr.	589ME
Breedte	mm 660
Spanning	V 230
LED	W 7,2
Capaciteit	lumen 2040
Gewicht	kg 1,22
Afmetingen (l x b x h)	mm 49 x 94 x 766
Prijs	€ 87,90

METALWORKS



Multifunctionele magnetische rail om ijzeren en stalen gereedschappen op te hangen. Kan magnetisch bevestigd worden aan een metalen achterwand zoals een werkbank of perfopaneel. Afmetingen 610x20x15mm. Capaciteit 2000 Gauss.

Order nr.	801106000
Orig. nr.	MAG600
Gewicht	kg 1,54
Prijs	€ 12,50

METALWORKS



Magneetbaar lengte 600mm. Perfect om uw stalen gereedschappen aan te hangen. Kan aan elke magnetische achtergrond worden bevestigd, alsook via 2 bevestigingshaken. Capaciteit 10kg per 3cm. Afmetingen 610x20x15mm.

Order nr.	801105600
Orig. nr.	MAG600A
Lengte	mm 600
Gewicht	kg 1,60
Prijs	€ 12,50

Metalworks universele kasten

METALWORKS



Universele kast. Stevige gelaste stalen constructie.

- met 4 liggers met capaciteit 50 kg, in hoogte verstelbaar
- 2-punt slot
- gepoederlakt
- deuren draaien tot 180° open

Order nr.	856001000	856001110	856001120
Orig. nr.	DEK7838	DEK11038	DEK11058
Type meubel	kast	kast	kast
Deuren	x	✓	✓
Draagcapaciteit	kg 50	50	50
Liggers	4	4	4
Slot	x	sleutel	sleutel
Gewicht	kg 50,00	80,00	85,00
Afmetingen (l x b x h)	mm 380 x 780 x 1920	380 x 1100 x 1920	580 x 1100 x 1920
Prijs	€ 329,00	409,00	465,00

Metalworks bakjeskasten

METALWORKS



Stalen bakjeskast met uitneembare kunststofbakjes. Met metalen tussenschotten tussen de rijen bakjes.

- stevig gelast frame
- gepoederlakt
- gemonteerd geleverd

Order nr.	856001210	856001300	856001200
Orig. nr.	DEBK30	DEBK48	DEBK114
Aantal bakjes	27 x ISPA04	48 x ISPA03	114 x ISPA02
Gewicht	kg 50,00	50,00	50,00
Afmetingen (l x b x h)	mm 650 x 405 x 1920	650 x 290 x 1920	650 x 200 x 1920
Prijs	€ 389,00	339,00	349,00

METALWORKS



Universele kast met 3 lades en perfwand/deur.

- met 4 liggers capaciteit 50kg
- 2-punt slot
- gepoederlakt
- compatibel met modular haken

Order nr.	856001310
Orig. nr.	DEK7838L
Type meubel	kast
Draagcapaciteit	kg 50
Materie	metaal
Laden	3
Liggers	4
Slot	sleutel
Gewicht	kg 50,00
Afmetingen (l x b x h)	mm 380 x 780 x 1920
Prijs	€ 474,00

METALWORKS



Stalen bakjeskast 2 afsluitbare deuren met uitneembare kunststofbakjes. Met metalen tussenschotten tussen de rijen bakjes.

- stevig gelast frame
- gepoederlakt
- gemonteerd geleverd
- cilinderslot

Order nr.	856001211	856001301	856001201
Orig. nr.	DEBK30D	DEBK48D	DEBK114D
Aantal bakjes	27 x ISPA04	48 x ISPA03	114 x ISPA02
Gewicht	kg 50,00	50,00	50,00
Afmetingen (l x b x h)	mm 650 x 450 x 1920	650 x 285 x 1920	650 x 205 x 1920
Prijs	€ 484,00	399,00	409,00

Metalworks kleerkasten

METALWORKS



Kleerkast 2- of 3-deurs met 2 of 3 compartimenten, ligger en 4 haken. Cilinderslot en deurventilatie.

- cilinderslot en deurventilatie
- hamerslag gelakt

Order nr.	856001312 €	856001313 €
Orig. nr.	DEK1K2	DEK1K3
Type meubel	kast	kast
Deuren	✓	✓
Materie	metaal	metaal
Liggers	2	2
Slot	sleutel	sleutel
Aantal deuren	2	3
Gewicht	kg 50,00	50,00
Afmetingen (l x b x h)	mm 500 x 600 x 1800	500 x 900 x 1800
Prijs	€ 204,00	274,00

Metalworks milieukasten

METALWORKS



Fytosanitaire metalen opbergkast, geschikt voor stockage van diverse veilig op te bergen vloeistoffen en producten. Stevige gelaste stalen constructie.

- 6 waterdichte opvangbakken met capaciteit 30 kg, in hoogte verstelbaar
- ventilatieschacht bovenaan en ventilatiegaten in achterwand
- 2-punt slot
- gepoederlakt
- deuren draaien tot 180° open

Order nr.	856001130 €
Orig. nr.	DEC9238
Type meubel	kast
Draagcapaciteit	kg 30
Materie	metaal
Liggers	6
Geschikt voor vloeistoffen	✓
Slot	sleutel
Gewicht	kg 75,00
Afmetingen (l x b x h)	mm 380 x 920 x 1920
Prijs	€ 459,00

Metalworks brandwerende kasten

METALWORKS



Brandveiligheidskasten met een brandwerendheid van 90 minuten bepaald volgens de Europese Norm EN 14470-1. Geschikt voor inpanidige opslag van brandgevaarlijke stoffen. Kwalitatief hoogwaardige kastromp uit Zincor plaatstaal. Standaard ingericht met 3 verstelbare legborden en verstelpootjes. Bodempopvang met inzerrooster. Zelfsluitend door middel van hydraulische deurdraner. Kleur: RAL7035. - Thermolock op ± 45°C (automatisch).

Order nr.	724576527 €	724576528 €
Orig. nr.	BVK1	BVK2
Aantal deuren	1	2
Gewicht	kg 230,00	375,00
Afmetingen (l x b x h)	mm 600 x 600 x 2035	1200 x 600 x 2035
Prijs	€ 2.655,00	2.859,00



Metalworks werfkoffers

METALWORKS

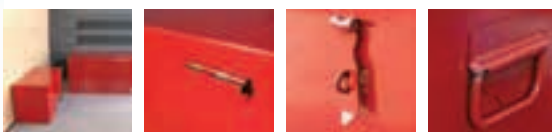

Deze handige Metalworks werfkoffer is vervaardigd uit een gelaste staalplaat van 1 tot 1,2mm. Rood gepoederlakt. Met 1 sluiting (type 550 en 670) of 2 sluitingen (800 en 1000) afsluitbaar met hangslot (niet meegeleverd). Met 2 stevige handvaten en 2 scharnieren.

Order nr.	758121550 €	758121670 €	758121800 €	758121100 €
Orig. nr.	SORCR550B	SORCR670B	SORCR800B	SORCR1000B
Staaldikte	mm 1,0-1,2	mm 1,0-1,2	mm 1,0-1,2	mm 1,0-1,2
Gewicht	kg 3,00	kg 4,00	kg 15,00	kg 20,00
Afmetingen (l x b x h)	mm 570 x 340 x 310	mm 700 x 390 x 360	mm 830 x 400 x 360	mm 1030 x 520 x 370
Prijs	€ 61,00	€ 71,00	€ 92,00	€ 124,00

METALWORKS



MWB195



MWB265

De Metalworks werfkoffers garanderen uw gereedschap en materialen een veilige opbergmogelijkheid op de werf, werkplaats, laadvak van een pick up en vrachtwagen. Diefstal gebeurt 1 geval op 3 door gelegenheidsdieven. Geef uw materiaal een vaste en veilige opslagplaats. Karakteristieken : stevige staalplaat van 1,5 en 5mm (naargelang type). Kleur : mat zwart gepoederlakt. Rondom de koffer is een anti-inbraak rand die geforceerd openen onmogelijk maakt. 2 stevige opklapbare stalen handgrepen. 2 hydraulische hulpveren voor een soepel openen van het deksel. Sluiting van de koffer met 2 Eurotype-cilindersloten verzonken in de koffer. Geleverd met 6 sleutels per koffers. Sterke gelaste pianoscharnier over de volledige lengte van het kofferdeksel.

Order nr.	758120195 €	758120265 €
Orig. nr.	MWB195	MWB265
Volume	l 195	l 265
Staaldikte	mm 1,5 - 3	mm 1,5 - 5
Gewicht	kg 36,60	kg 52,50
Afmetingen (l x b x h)	mm 970 x 490 x 460	mm 1310 x 490 x 460
Prijs	€ 246,00	€ 326,00



MWB445



MWB700



De Metalworks werfkoffers garanderen uw gereedschap en materialen een veilige opbergmogelijkheid op de werf, werkplaats, laadvak van een pick up en vrachtwagen. Diefstal gebeurt 1 geval op 3 door gelegenhedsliefden. Geef uw materiaal een vaste en veilige opslagplaats. Karakteristieken : stevige staalplaat van 1,5 en 5mm (naargelang type). Kleur : mat zwart gepoederlakt. Rondom de koffer is een anti-inbraak rand die geforceerd openen onmogelijk maakt. 2 stevige opklapbare stalen handgrepen. 2 hydraulische hulpveren voor een soepel openen van het deksel. Sluiting van de koffer met 2 Eurotype-cilindersloten verzonken in de koffer. Geleverd met 6 sleutels per koffers. Sterke gelaste pianoscharnier over de volledige lengte van het kofferdeksel. Voorzien van 2 vorksheftrucks.

Order nr.		758120445 €	758120700 €
Orig. nr.		MWB445	MWB700
Volume	l	445	700
Staaldikte	mm	2 - 5	2 - 5
Gewicht	kg	71,50	114,20
Afmetingen (l x b x h)	mm	1180 x 640 x 630	1860 x 640 x 630
Prijs	€	419,00	699,00

METALWORKS



De Metalworks werkkoffers garanderen uw gereedschap en materialen een veilige opbergmogelijkheid op de werf, werkplaats, laadvak van een pick up en vrachtwagen. Diefstal gebeurt 1 geval op 3 door gelegheidsdieven. Geef uw materiaal een vaste en veilige opslagplaats. Karakteristieken : stevige staalplaat van 1,5 en 5mm (naargelang type). Kleur : mat zwart gepoederlakt. Rondom de koffer is een anti-inbraak rand die geforceerd openen onmogelijk maakt. 2 stevige opklapbare stalen handgrepen. 2 hydraulische hulpveren voor een soepel openen van het deksel. Sluiting van de koffer met 2 Eurotype-cilindersloten verzonken in de koffer. Geleverd met 6 sleutels per koffers. Sterke gelaste pianoscharnier over de volledige lengte van het kofferdeksel. Voorzien van 2 vorksheuven voor manipulatie met een vorkheftruck.

Order nr.	758120905	
Orig. nr.	MWB905	
Volume	l	905
Staaldikte	mm	2 - 5
Gewicht	kg	164,70
Afmetingen (l x b x h)	mm	1180 x 640 x 1280
Prijs	€	759,00

METALWORKS



4-delige wielenset voor werkkoffers MWB445, MWB700 en MWB905. Bevestigingsgaten niet voorzien in de koffers. Gemakkelijk transporteren van uw werkkoffer.

Order nr.	758120446	
Orig. nr.	MWB4WS	
Gewicht	kg	3,50
Prijs	€	91,00

Metalworks magazijnbakjes

METALWORKS



Rail metaal 50 cm voor het ophangen van magazijnbakjes aan bvb. muur.

Order nr.	755000101 €	
Orig. nr.	ISRAIL	
Gewicht	kg	0,10
Prijs	€	6,10

METALWORKS



Stevig opbergbakje vervaardigd uit polyurethaan. Met kaartvakje aan de voorkant. Blauwe uitvoering. Niet geschikt voor de VTC-richtingen. VE = verpakkingseenheid.

Order nr.	755002020 €	755003030 €
Orig. nr.	ISPA02	ISPA03
Gewicht	kg 8,44	12,69
VE	96	48
Afmetingen (l x b x h)	mm 165 x 100 x 82	230 x 153 x 125
Prijs/VE	€ 96,90	136,00

Order nr.	755004040 €	755005050 €
Orig. nr.	ISPA04	ISPA05
Gewicht	kg 12,84	4,14
VE	24	4
Afmetingen (l x b x h)	mm 335 x 210 x 175	475 x 308 x 187
Prijs/VE	€ 144,00	46,35

METALWORKS



Stevig opbergbakje vervaardigd in PP. Breekt niet door blootstelling aan de zon. VE = verpakkingseenheid.

Order nr.	815614110 €	815614150 €	815614120 €
Orig. nr.	DBOC21	DBOC26	DBOC31
Gewicht	kg 0,21	0,23	0,46
Afmetingen (l x b x h)	mm 148 x 240 x 125	148 x 270 x 125	209 x 335 x 160
Prijs	€ 109,00	74,00	206,00

VTC

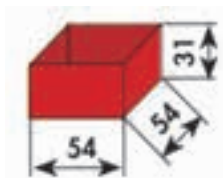

P4010

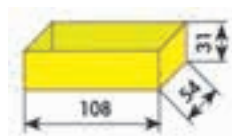

P4020

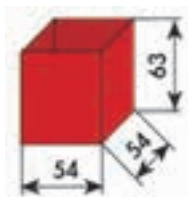

P4030

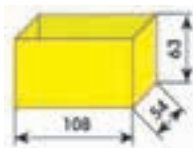

P4040 (= P4020 + P4020)



P4050 (= P4040 + P4040)



P4060 (= P4040 + P4040 + P4040)



P4065 (= P4050 + P4050)

Kunststof bakjes. VE = verpakkingseenheid.

Order nr.	Orig. nr.	Omschrijving	Afmetingen (l x b x h) mm	VE	Prijs/VE €
815614011	€ P4010S	bakje 4010 enkel laag rood	54 x 31 x 54	60	26,50
815614021	€ P4020S	bakje 4020 dubbel laag geel	108 x 31 x 54	60	34,50
815614031	€ P4030S	bakje 4030 enkel hoog rood	54 x 63 x 54	60	39,50
815614041	€ P4040S	bakje 4040 dubbel hoog geel	108 x 63 x 54	60	62,00
815614051	€ P4050S	bakje 4050 dubbel hoog blauw	108 x 63 x 108	60	72,90
815614061	€ P4060S	bakje 4060 dubbel hoog groen	162 x 63 x 108	40	69,90
815614066	€ P4065S	bakje 4065 dubbel hoog grijs	216 x 63 x 108	30	84,50



Metalen koffers.

Order nr.	Orig. nr.	Omschrijving	Gewicht kg	Afmetingen (l x b x h) mm	Prijs €
815616600	Z6600	Koffer 6600 leeg (H: 6,6 cm)	2,95	440 x 330 x 66	64,50
815616601	Z6601	Koffer met verdeling in compartimenten	3,49	440 x 330 x 66	101,00
815616608	Z6608	Type 6600 met 8 compartimenten	3,58	440 x 330 x 66	77,50
815616611	Z6611	Type 6600 met 11 compartimenten	3,56	440 x 330 x 66	79,90
815616612	Z6612	Type 6600 met 12 compartimenten	3,71	440 x 330 x 66	80,00
815616623	Z6623	Type 6600 met 23 compartimenten	3,65	440 x 330 x 66	89,00
815616624	Z6624	Type 6600 met 24 compartimenten	3,55	440 x 330 x 66	88,90
815616648	Z6648	Type 6600 met 48 compartimenten	3,75	440 x 330 x 66	99,00
815616649	Z6649	Type 6600 met 49 compartimenten	4,28	440 x 330 x 66	98,50
815610000	Z10000	Koffer 10000 leeg (H : 10 cm)	3,26	440 x 330 x 100	70,00
815610001	Z10001	Koffer met verdeling in compartimenten	4,02	440 x 330 x 100	117,00
815610039	Z10039	Type 10000 met 39 compartimenten	4,52	440 x 330 x 100	99,00
815610040	Z10040	Type 10000 met 40 compartimenten	4,48	440 x 330 x 100	108,00
815610048	Z10048	Type 10000 met 48 compartimenten	4,65	440 x 330 x 100	105,00
815610059	Z10059	Type 10000 met 59 compartimenten	4,70	440 x 330 x 100	116,00
815613000	Z13000	Koffer 13000 leeg (H : 13 cm)	3,57	440 x 330 x 130	79,90
815613001	Z13001	Koffer met verdeling in compartimenten	4,52	440 x 330 x 130	127,00
815613030	Z13030	Type 13000 met 30 compartimenten	6,06	440 x 330 x 130	103,00
815613042	Z13042	Type 13000 met 42 compartimenten	6,12	440 x 330 x 130	108,00
815613044	Z13044	Type 13000 met 44 compartimenten	6,06	440 x 330 x 130	108,00
815613046	Z13046	Type 13000 met 46 compartimenten	6,12	440 x 330 x 130	119,00
815617301	Z17301	Koffer met verdeling in compartimenten	5,16	440 x 330 x 173	126,00
815617300	Z17300	Koffer 17300 leeg (H : 17,3 cm)	3,94	440 x 330 x 173	74,00

SERIE 6600

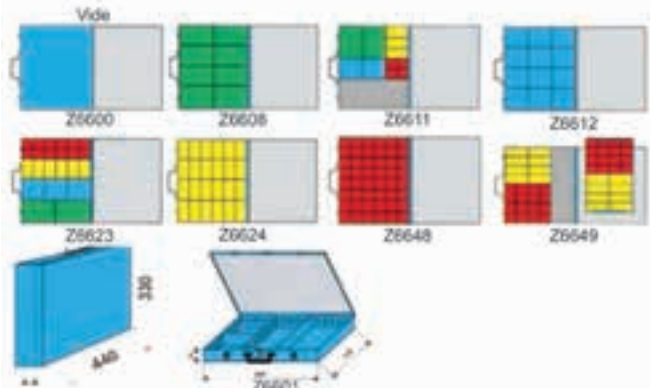

SERIE 10000

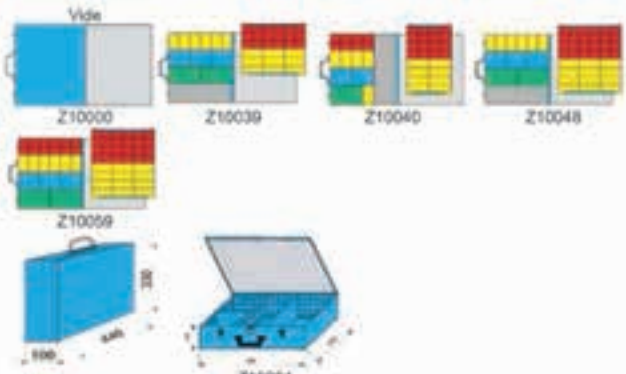

SERIE 13000

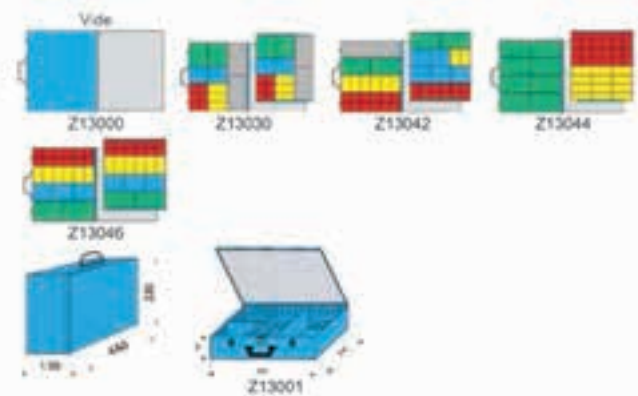

SERIE 17300





Luchtslangen



NEW

Soft PVC slang versterkt met polyestervezels. Met Euro snelkoppelingen. 712105550 + 712105750 zonder koppeling.

Order nr.	712105610	712105910	712105520	712105420
Orig. nr.	2105410	2105510	2105520	2105420
Lengte m	10	10	20	20
Diameter inwendig mm	6	9	9	6
Diameter uitwendig mm	10,7	14,50	14,50	10,70
Maximum druk bar	20	20	20	20
Gewicht kg	0,90	1,47	9,20	0,90
Prijs €	16,00	20,00	40,00	32,00

Order nr.	712105650	712105950	712105703
Orig. nr.	2105450	2105550	2105750
Lengte m	50	50	50
Diameter inwendig mm	6	9	13
Diameter uitwendig mm	10,7	14,50	19,00
Maximum druk bar	20	20	20
Gewicht kg	3,85	6,70	9,00
Prijs €	44,00	60,00	78,00



NEW

Spiraalslang met snelkoppeling en tuit.

Order nr.	712115608
Orig. nr.	2115608
Lengte m	7,5
Maximum druk bar	10
Diameter mm	6-10
Gewicht kg	0,34
Prijs €	14,00



PRO

NEW

Spiraalslang. Pro PU met snelkoppeling Aircraft. Met draaistuk 360°. Hoge flexibiliteit en kniksterkte.

Order nr.	712105854	712105850
Orig. nr.	2105854	2105850
Lengte slang m	6	6
Aansluiting inch	1/4	1/4
Maximum druk bar	10	12
Diameter mm	8-12	5-8
Gewicht kg	0,40	0,40
Prijs €	35,00	26,50

Blaaspistolen



2102100



2102110

Blaaspistool in aluminium.

Order nr.	712102100	712102110
Orig. nr.	2102100	2102110
Lengte mm	25	200
Prijs €	4,60	5,90



PNBL150



PNBL300

Blaaspistool in kunststof met 2 lengte blaaspijp.

Order nr.	737551500	737553000
Orig. nr.	PNBL150	PNBL300
Lengte blaaspijp mm	150	300
Prijs €	6,50	12,00



NEW

Universeel blaaspistool met grote hendel voor goede dosering. Toepassingen in productie, werkplaats en automotive. Met koppeling.

Order nr.	712112120
Orig. nr.	BPPRO
Prijs €	7,90



EXTRA LANG

Blaaspistool BP PRO.

Order nr.	712112124	712112125
Orig. nr.	BP PRO XL	BP PRO XXL
Werkdruk bar	2-6	2-6
Luchtverbruik l/min	100-200	100-200
Lengte blaaspijp mm	500	800
Prijs €	18,00	25,00

Zaircraft



NEW

Schermplaat BP PRO beschermt ogen en gezicht tegen opspattende deeltjes.

Order nr.	712112150 ^M
Orig. nr.	2112150
Prijs	€ 7,00

Zaircraft



PRO R kunststof blaaspistool voor gevoelige oppervlakken. Afneembare rubberkop. Regelbare max. druk. Groot handvat voor dosering.

Order nr.	712112130 ^M	712102125 ^T
Orig. nr.	2112130	BPP PRO G
Werkdruk	bar 2-6	2-6
Luchtverbruik	l/min 100-200	100-200
Regelbaar	Ja	Nee
Prijs	€ 13,50	10,00

Zaircraft



BPP PRO V

Blaaspistool in kunststof. Professioneel model. Circa 100% hogere luchtdoorvoer door de venturi-kop. Prima debietregeling dankzij de lange hendel.

Order nr.	712102124 ^T
Orig. nr.	2112122
Werkdruk	bar 2-6
Luchtverbruik	l/min 100-200
Prijs	€ 13,90

Zaircraft



8-delig assortiment van pneumatisch gereedschap. Bestaat uit 1 kort blaaspistool, 1 bandenblazer, 3 blaasstukjes, 1 verfpistool, 1 vernevelpistool en 1 spiraalslang.

Order nr.	712102008 ^T
Orig. nr.	2102008
Prijs	€ 44,00

Zaircraft



Blaaspistool in aluminium. Professioneel model. Extra hoge luchtdoorvoer dankzij de venturi-naald -en kop.

Order nr.	712102170 ^T
Orig. nr.	BPI PRO
Werkdruk	bar 1-6
Luchtverbruik	l/min 100-200
Prijs	€ 16,00

Zaircraft



NEW

Professioneel blaaspistool met fijnregeling van het debiet. 2 aansluitingen voor luchtinlaat boven- en onderaan. Voorkom verwarde toevoerslangen. Met lange en korte blaastuit.

Order nr.	712102190 ^T
Orig. nr.	BP PRO DUO
Prijs	€ 22,50

Zaircraft



Nippel. Compatibel met Aircraft compressoren en airtools.

Order nr.	712201041 ^M	712201042 ^M
Orig. nr.	2201041	2201042
Aansluiting	inch 1/4	3/8
VE	1	1
Min. bestelhoeveelheid	6	6
Prijs/VE	€ 1,85	2,05

Bandenblazers



Bandenblazer. Met snelkoppeling.

Order nr.	712102300		
Orig. nr.	2102300		
Werkdruk maximum	bar	8	
Aflezing	bar	0-8	
Prijs	€	16,00	



Accessoires voor bandenblazer.

Order nr.	712102301	712102302	712102304
Orig. nr.	2102301	2102302	2102304
Accessoire	Snelkoppeling	Vervangmanometer diam. 63 mm	vervangslang
Prijs	€	3,20	8,00
			4,80



Set van 3 blaasstukjes. Ideaal voor het gebruik thuis. Bevat een fietsadaptor, een smalle en dikke naald voor fietsen, ballen, opblaasbootjes en luchtmatrassen.

Order nr.	712102900		
Orig. nr.	2102900		
Prijs	€	5,20	



Opblaasstuk. Met rubber handvat en dubbelzijdige vulnippel-koppeling 6 mm.

Order nr.	712102605		
Orig. nr.	2102605		
Prijs	€	10,90	



Bandenblazer. Geijkte versie. Professionele uitvoering. Met snelkoppeling. Zeer duidelijke en grote aflezing (diam. 80mm).

Order nr.	712102600		
Orig. nr.	2102600		
Werkdruk maximum	bar	12	
Aflezing	bar	0-10	
Prijs	€	72,00	



Accessoires voor bandenblazer.

Order nr.	712102601		
Orig. nr.	2102601		
Omschrijving	Vervangmanometer voor PRO-G - diam. 80 mm		
Prijs	€	42,00	



NEW

Compacte bandenblazer in professioneel alu uitvoering met blaasnippel met grote geijkte manometer Ø 63mm.

Order nr.	712103010		
Werkdruk maximum	bar	10	
Aflezing	bar	0-10	
Prijs	€	92,50	



Luchtdruktester. Hoofdzakelijk voor autobanden. Met kaliber voor min. druk 0,5 bar/7,5 PSI tot max. 3 bar/43 PSI. Zeer accurate en makkelijk te lezen display. Lang recht model. Dubbel zijde druktuit. Geleverd met ophanging.

Order nr.	208260109		
Orig. nr.	208260109		
Prijs	€	16,50	



NEW

PRO-E profi bandenblazer met snelstekker.

Order nr.	712102700 M
Orig. nr.	2102700
Werkdruk maximum	bar 10
Prijs	€ 49,00

Siliconespuiten



NEW

Pneumatische siliconespuit. Geschikt voor alle standaard cartouches. Met snelontluchting.

Order nr.	712102250 T
Orig. nr.	2102250
Werkdruk	bar 1,52
Luchtverbruik	l/min +/-50
Prijs	€ 49,00



NEW

Pneumatisch cartouchepistool. Professioneel model. Geschikt voor alle standaard cartouches. Met snelontluchting en zonder materiaal-drup. Traploos regelbaar.

Order nr.	712102270 T
Orig. nr.	2102270
Werkdruk	bar 1,52
Luchtverbruik	l/min 60
Prijs	€ 189,00

Plaatbewerking



Boormachine links-rechts draaiend BM PRO. Lichte en handige boormachine met links-rechts schakelaar voor hout en metaal. De luchtuitlaat gebeurt via het handvat om werveling van braamsel te vermijden. De boormachine is uitgerust met een zelfspannende boorkop 1-10 mm en handgreep.

Order nr.	712404100 T
Orig. nr.	2404100
Capaciteit staal	mm 10
Capaciteit hout	mm 20
Werkdruk	slagen/min 6
Luchtverbruik	m/s ² 360
Toerental onbelast	rpm +/- 1800
Prijs	€ 49,00



Boormachine. Links-rechts draaiend. Met composietbehuizing. Lichte en handige boormachine met links-rechts schakelaar voor hout en metaal. De luchtuitlaat gebeurt via het handvat om werveling van braamsel te vermijden. De boormachine is uitgerust met een zelfspannende boorkop 3/8" 1-10 mm en handgreep.

Order nr.	712404150 T
Orig. nr.	2404150
Werkdruk	bar 6,3
Luchtverbruik	l/min 460
Toerental	tpm 1800
Prijs	€ 79,00



Haakse slijper. Voor schijven tot diameter 125mm. Hoge capaciteit.

Order nr.	712403470 T
Orig. nr.	2403470
Werkdruk	bar 6,3
Luchtverbruik	l/min 490
Aansluiting	mm 22
Toerental	tpm 10000
Prijs	€ 139,00



aircraft



NEW

Plaatsnijder voor diverse toepassingen :

- Voor het uitsnijden van autoruiten en andere kleefverbindingen.
- Veiligheid tegen onbedoeld inschakelen.
- Geluidsarm werken.
- Ook bruikbaar met schuur schijven.
- Geleverd met set snijmesses en koffer.

Order nr.		712404850
Toerental	l/min	20.000
Werkdruk	bar	6.3
Luchtverbruik	l/min	280
Prijs	€	149,00

aircraft



NEW

Professionele knabberschaar.

Order nr.		712404550
Orig. nr.		2404550
Snijbreedte	mm	5
Snijcapaciteit - staalplaat	mm	1,2
Snijcapaciteit - aluminiumplaat	mm	1,6
Snijsnelheid	slagen/min	2600
Prijs	€	84,00

aircraft



Rechte snelslijper. 5 slijpstenen op as diam. 3 mm, 5 slijpstenen op as diam. 6 mm, 1 bits en 1 adapter voor 3 en 6 mm, gereedschap, geleverd in een plastic koffer. Voor het slijpen, borstelen en afbramen.

Order nr.		712403190
Orig. nr.		2403190
Werkdruk	bar	6
Luchtverbruik	l/min	270
Toerental onbelast	rpm	+/- 24000
Prijs	€	36,00

aircraft



Rechte slijper. Met ergonomische handgrip in kunststof voor isolatie tegen vibraties en koude luchtstroom. Set bevat 2 spanklauwen (3mm en 6 mm), 5 slijpstenen, 1 adaptor en spanwerk tuigen. Voor slijpen, borstelen en afbramen. In hoogwaardige kunststofkoffer.

Order nr.		712403200
Orig. nr.		2403200
Werkdruk	bar	6,3
Luchtverbruik	l/min	330
Aansluiting	mm	6
Toerental	tpm	22000
Prijs	€	69,00

Clux



Rechte slijper. Speciaal ontworpen voor roterende vijlen en slijpstenen. High speed vermogen. Voor schacht diameter 3 mm. Voorzien van traploze snelheidsregeling en een koppeling die 360° draaibaar is. Speciaal ontworpen voor gemakkelijk gebruik. Standaard geleverd met een adapter 3 mm en een luchtslang (1.5 m) inclusief slang voor luchtafvoer (0.3 m).

Order nr.	207400102	207400201
Orig. nr.	207400102	207400201
Toerental	tpm	70000
Geluidsniveau	dB(A)	81
Vibratie	m/s ²	2,0
Minimum maat slang	inch	5/16
Luchtaansluiting	G (R)	1/4
Lengte	mm	137
Voor schacht diameter	mm	3
Prijs	€	103,00
		126,00

Cluna



Rechte slijper. Speciaal ontworpen voor roterende vijlen en slijpstenen. Voor schacht diameter 3 mm, 6 mm en 1/4". Voorzien van luchtafvoer langs achteren, veiligheidshendel om ongewild starten te voorkomen, ingebouwde snelheidsregulator en een koppeling die 360° draaibaar is. Ontworpen voor gemakkelijk gebruik met ergonomisch rubberen handvat. Bescherming tegen koude luchtstromen voor comfortabel gebruik. Handig voor gebruik op moeilijk te bereiken plaatsen. Standaard geleverd met een adaptor 3 mm, een adaptor 6 mm en een adaptor 1/4".

Order nr.	207370107	
Orig. nr.	207370107	
Toerental	tpm	25000
Voor schacht diameter	mm/inch	3-6-1/4
Geluidsniveau	dB(A)	83
Vibratie	m/s ²	3,6
Minimum maat slang	inch	3/8
Luchtaansluiting	G (R)	1/4
Lengte	mm	160
Prijs	€	97,90

Cluna

Verloopstuk voor haakse slijper.

Order nr.	207360504	207360603	207360702
Orig. nr.	207360504	207360603	207360702
Lengte	3 mm	6 mm	1/4"
Prijs	€ 8,80	8,80	8,80

Cluna



Rechte slijper. Speciaal ontworpen voor roterende vijlen en slijpstenen. Voor schacht diameter 3 mm, 6 mm en 1/4". Voorzien van luchtafvoer langs achteren, veiligheidshendel om ongewild starten te voorkomen, ingebouwde snelheidsregulator en een koppeling die 360° draaibaar is. Ontworpen voor gemakkelijk gebruik met ergonomisch rubberen handvat. Bescherming tegen koude luchtstromen voor comfortabel gebruik. Handig voor gebruik op moeilijk te bereiken plaatsen. Mini model in set (12977) standaard geleverd met een adaptor 3 mm, een adaptor 6 mm en een adaptor 1/4", 5 stuks slijpstenen 3 mm, 5 stuks slijpstenen 6mm, een mini oliebusje en twee opspanstukken.

Order nr.	207390105	
Orig. nr.	207390105	
Toerental	tpm	25000
Geluidsniveau	dB(A)	86
Vibratie	m/s ²	3,6
Minimum maat slang	inch	3/8
Luchtaansluiting	G (R)	1/4
Lengte	mm	160
Voor schacht diameter	mm	3-6-1/4
Prijs	€	126,00

Slagmoersleutels

Aircraft



Slagmoersleutel - Assortiment 1/2" SS S. Geleverd in een plastieken opbergkoffer. Links-rechts slagmoersleutel met klein-hamer systeem. Geschikt voor het lichte industriële werk. Zijn minimaal eigengewicht, ergonomische vorm en regelbaar koppell garanderen een prima toestel. De rubberen hoed rond het handvat verhindert een koude luchtstroom.

Order nr.	712401100	
Orig. nr.	2401100	
Aansluiting	inch	1/2
Werkdruk	bar	6
Luchtverbruik	l/min	360
Koppel	ca. Nm	345
Prijs	€	60,00

Aircraft



Slagmoersleutelset 1/2". Dubbelsagsysteem met snelle werking composiet handvat. Met 10 doppen en inline olieverniveelaar. 3-standen (moment instelbaar).

Order nr.	712401220	
Orig. nr.	2401220	
Luchtverbruik	l/min	420
Koppel	ca. Nm	560
Maten slagdoppen - standaard	mm	9-10-11-13-14-17-19-22-24-27
Prijs	€	119,00



Slagmoersleutel. Met composietbehuizing uit slagvaste kunststof. Vibratiearm, koudgeïsoleerd handvat. Laag eigengewicht en compacte vorm. Aandraaimoment verstelbaar in 3 trappen. Geen opwaaien van remstof door afvoerlucht over de handgreep. Geschikt voor bandenwissels, reparatie en montage.

Order nr.	712401400	712401420
Orig. nr.	2401400	2401420
Aansluiting	inch 1/2	1/2
Werkdruk	bar 6,3	6,3
Luchtverbruik lastloop	l/min 420	410
Luchtverbruik leegloop	l/min 530	540
Koppel rechtsloop	Nm 270-340-430	300-700-800
Koppel linksloop	Nm 540	1080
Snelheid onbelast	tpm 10000	10000
Vibratie	m/s ² 1,2	2,2
Prijs	€ 179,00	199,00

Order nr.	712401440	712401450
Orig. nr.	2401440	2401450
Aansluiting	inch 3/4	1
Werkdruk	bar 6,3	6,3
Luchtverbruik lastloop	l/min 510	520
Luchtverbruik leegloop	l/min 700	730
Koppel rechtsloop	Nm 350-1100-1350	350-1100-1350
Koppel linksloop	Nm 1620	1620
Snelheid onbelast	tpm 4500	4500
Vibratie	m/s ² 3,8	5,0
Prijs	€ 489,00	599,00



Slagmoersleutel met dubbel hamersysteem composiet handvat - industriëitvoer 3/4" met composietbehuizing uit slagvaste anti-slip kunststof. Vibratiearm en met laag eigengewicht. Aandraaimoment rechtsloop instelbaar in 3 trappen.

Order nr.	712401260
Orig. nr.	2401260
Aansluiting	inch 3/4
Werkdruk	bar 6,3
Luchtverbruik lastloop	l/min 510
Koppel rechtsloop	Nm 3 standen - max 1220
Koppel linksloop	Nm 1220
Prijs	€ 189,00



Slagmoersleutel - industrie - 1". Slagmoersleutel links-rechts met dubbel hamerslagstelsel. Met lange as, die diepliggende moeren bereikbaar maakt zonder het gebruik van verlengstukken. Regelbaar koppel in beide richtingen. Voor het zwaardere en meer intensieve onderhouds- en industriewerk. De ideale sleutel voor bandenwissel van zware vrachtwagens, bussen, enz....

Order nr.	712401300
Orig. nr.	2401300
Aansluiting	inch 1
Werkdruk	bar 6
Luchtverbruik	l/min 560
Koppel	ca. Nm 2600
Prijs	€ 389,00



Slagmoersleutel met dubbel hamersysteem - industriëitvoer 1" met composietbehuizing uit slagvaste anti-slip kunststof. Vibratiearm en met laag eigengewicht. Aandraaimoment rechtsloop instelbaar in 3 trappen.

Order nr.	712401310
Orig. nr.	2401310
Aansluiting	inch 1"
Werkdruk	bar 6,3
Luchtverbruik lastloop	l/min 570
Koppel rechtsloop	Nm 3 standen - max 2800
Koppel linksloop	Nm 2800
Prijs	€ 399,00



Kleine en handige. Haakse slagmoersleutel. Instelbare torsie op de kop.

Order nr.	712401500	
Orig. nr.	2401500	
Aansluiting	inch	1/4
Werkdruk	bar	6
Luchtverbruik	l/min	210
Torsie	Nm	33
Toerental	tpm	110
Prijs	€	72,00



Haakse slagmoersleutel 1/2". Rubber kop voor krasvrij werken. Ergonomische kuststofgrip voor isolatie tegen vibraties en koude luchtstroom. Eenvoudig instellen van de draairichting.

Order nr.	712401520	
Orig. nr.	2401520	
Aansluiting	inch	1/2
Werkdruk	bar	6,3
Luchtverbruik	l/min	170
Torsie	Nm	135
Toerental	tpm	160
Prijs	€	99,00

TENGTTOOLS



Haakse slagmoersleutel set. Robuust en krachtig, speciaal ontworpen voor professioneel gebruik. Geproduceerd uit staal van hoge kwaliteit. Ergonomisch handvat met rubberen bedekking voor betere grip en isolatie tegen trillingen. De set bevat 7 Teng Tools slagdoppen, waaronder de meest gebruikte maten van 10 tot 19mm, een verlengstuk en een universele koppeling. De set bevat bovendien een mini-olievernevelaar. Geleverd in een handige doos, voorzien van handvat, klikslot en rubberen voetjes om het uitglijden te vermijden.

Order nr.		168890101	168880102
Orig. nr.		TA3812	TA1217
Aansluiting	inch	3/8	1/2
Toerental	tpm	160	160
Boutcapaciteit	mm	M5-M8	M6-M10
Maximum torsie	Nm	95	95
Aanbevolen torsie	Nm	15-90	15-90
Geluidsniveau (ISO86627)	dB(A)	91,6	91,6
Vibratie (ISO 15744:1999)	m/s ²	4,31	4,31
Luchtaansluiting	G (R)	1/4	1/4
Luchtverbruik (bij 15% interval)	l/min	86	86
Leugte	mm	292	292
Maten slagdoppen	mm	8, 10, 11, 12, 13, 15, 16, 17, 19	10, 11, 12, 13, 15, 17, 19
Gewicht ratel	kg	1,26	1,26
Prijs	€	126,00	124,00

TENGOOLS

Slagmoersleutel set. TA1221C met behuizing in composiet (omkeerbaar: 3-traps vooruit en 2-traps achteruit). TA1221M met een standaard behuizing. De set bevat 9 Teng Tools slagdoppen, waaronder de meest gebruikte maten van 10 tot 21mm, een verlengstuk en 3 diepe wioldoppen en een mini-olievervelaar. Geleverd in een handige doos, voorzien van handvat, klijslot en rubberen voetjes om het uitglijden te vermijden.

Order nr.	168870103	168860104
Orig. nr.	TA1221C	TA1221M
Aansluiting	inch 1/2	1/2
Toerental	tpm 8500	7500
Boutcapaciteit	mm M8-M16	M10-M18
Maximum torsie	Nm 650	665
Geluidsniveau (ISO8662:7)	dB(A) 97,5	98,7
Minimum maat slang	inch 3/8	3/8
Luchtaansluiting	G (R) 1/4	1/4
Luchtverbruik (bij 15% interval)	l/min 133	133
Maximum torsie (3 stappen)	Nm 390-520-650	400-535-665
Type hamermechanisme	twin hammer	twin hammer
Maten slagdoppen - standaard	mm 10, 11, 13, 15, 16, 17, 18, 19, 21	10, 11, 13, 15, 16, 17, 18, 19, 21
Maten slagdoppen - verlengd	mm 17, 19, 21	17, 19, 21
Lengte verlengstuk	mm 20x3,5 (2x) - 25x3,5 (2x)	20x3,5 (2x) - 25x3,5 (2x)
Gewicht ratel	kg 1,9	2,6
Prijs	€ 259,00	239,00

TENGOOLS

Slagmoersleutel. TTDAW12C met behuizing in composiet. TTDAW12M met een standaard behuizing. Omkeerbaar: 3-traps vooruit en 2-traps achteruit. Lichte slagmoersleutel met geluidsabsorberend vermogen. Ergonomische grip door rubberen handvat die tevens isoleert tegen koude luchtstroom en vibraties. Voorzien van een koppeling die 360° draaibaar is, om het gebruiksgemak te verhogen. Traploze trekker. Speciaal ontworpen voor professioneel gebruik.

Order nr.	168840106	
Orig. nr.	TTDAW12C	
Aansluiting	inch	1/2
Boutcapaciteit	mm	M8-M16
Toerental	tpm	8500
Maximum torsie	Nm	650
Maximum torsie (3 stappen)	Nm	390-520-650
Mechanisme twin hammer	✓	
Geluidsniveau (ISO8662:7)	dB(A)	97,5
Vibratie (ISO 15744:1999)	m/s ²	4,42
Minimum maat slang	inch	3/8
Luchtaansluiting	G (R)	1/4
Luchtverbruik (bij 15% interval)	l/min	133
Afmetingen (l x b x h)	mm	280 x 280 x 80
Prijs	€	195,00

Beitelhamers

Zaircraft

Hakhamer - universeel assortiment. Lichte en handige hakhamer voor universeel gebruik in plasticen opbergkoffer. Bevat puntbeitel, platte beitel, rivetten beitel, plaat beitel, universele beitel, veer en oliepul. De zeskantopname vermijdt het rondraaien van de beitels.

Order nr.	712402200	
Orig. nr.	2402200	
Luchtverbruik	l/min	280
Aantal slagen	rpm	+/- 3000
Prijs	€	64,00

aircraft



Hakhamer. Lichte en handige hakhamer voor universeel gebruik. Set bevat puntbeitel, platte beitel, rivetten beitel, plaat beitel, universele beitel en veer. De zeskantopname voorkomt het ronddraaien van de beitels. In hoogwaardige kunststofkoffer.

Order nr.	712402300	
Orig. nr.	2402300	
Aansluiting	mm	10
Werkdruk	bar	6,3
Luchtverbruik	l/min	240
Aantal slagen	rpm	2200
Prijs	€	95,00

aircraft



Wisselbeitels en accessoires voor de set MHU-MHV-MHB.

Order nr.	Orig. nr.	Omschrijving	Prijs €
712402101	2402101	veer	2,90
712402219	2402219	platte beitel 180mm	8,00
712402227	2402227	platte beitel 20mm/180mm	6,00
712402382	2402382	platte beitel 30mm/250 mm	11,00
712402239	2402239	puntbeitel 3mm/175 mm	6,00
712402381	2402381	puntbeitel 4mm/250 mm	9,00
712402243	2402243	schrapper 50mm/180mm	12,00
712402383	2402383	schrapper 40mm/250 mm	11,00
712402384	2402384	holle beitel 24mm/240mm	13,00

Verfpistolen

aircraft

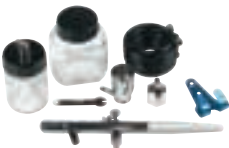

Airbrush verfpistoolkit. Sproeier 0,3mm. Voor de kwaliteitsbewuste hobbyist. Eenhandsbediening van verf- en luchtregeling. Met metalen beker van 5cc en 2 glazen bekertjes van 22 en 50cc. Met 2m leiding, pistoolhouder en koppeling. Verpakt in een handig kunststof doosje.

Order nr.	712101050	
Orig. nr.	2101050	
Sproeier	mm	0,3
Prijs	€	52,00

aircraft



Accessoires voor Airbrush verfpistool.

Order nr.	712101052	
Orig. nr.	2101052	
Omschrijving	Naaldset 0,3 mm	
Prijs	€	20,00

aircraft



Verfpistool met bovenbeker. Met mini-bovenbeker 100ml. Rond of plat regelbare straal. Regeling van verfdebiet. Veelzijdig inzetbaar in de modelbouw en automobielsector voor moeilijk bereikbare plaatsen.

Order nr.	712101260	
Orig. nr.	2101260	
Luchtverbruik	l/min	30-60
Sproeier	mm	0,5
Werkdruk	bar	1-3
Prijs	€	34,00

aircraft



Accessoires voor ES verfpistool.

Order nr.	712101265	712101267	712101261
Orig. nr.	2101265	2101267	2101261
Omschrijving	Naaldset 0,5 mm	Naaldset 0,7 mm	Kunststof beker
Prijs	€	10,50	10,50

aircraft



Verfpistool met bovenbeker 500ml. Rond of plat regelbare straal. Regeling van verfdebiet. Voor universeel gebruik in industrie en automobielsector.

Order nr.	712101400	
Orig. nr.	2101400	
Luchtverbruik	l/min	100-200
Sproeier	mm	1,5
Werkdruk	bar	3,0-4,5
Prijs	€	20,00



Accessoires voor SD verfpistool.

Order nr.	Orig. nr.	Omschrijving	Prijs €
712101401 T	2101401	vervangbeker	11,00
712101412 T	2101412	Naaldset 1,2 mm	15,00
712101415 T	2101415	Naaldset 1,5 mm	15,00
712101420 T	2101420	Naaldset 2,0 mm	15,00
712101425 T	2101425	Naaldset 2,5 mm	15,00



Verfpistool met bovenbeker. Met bovenbeker 750ml. Rond of plat regelbare straal. Regeling van druk en verfdiebt. Met verffilter. Voor professioneel gebruik in industrie en automobielsector.

Order nr.	712101600 T		
Orig. nr.	2101600		
Luchtverbruik	l/min	150-200	
Sproeier	mm	1,5	
Werkdruk	bar	3,5-4,0	
Prijs	€	79,00	



Accessoires voor HVLP verfpistool.

Order nr.	Orig. nr.	Omschrijving	Prijs €
712101614 T	2101614	Naaldset 1,4 mm	33,00
712101617 T	2101617	Naaldset 1,7 mm	33,00
712101620 T	2101620	Naaldset 2,0 mm	33,00
712101622 T	2101622	Naaldset 2,2 mm	33,00
712101601 T	2101601	Plastieke beker 0,75 l	11,00



Verfpistool met bovenbeker. Met bovenbeker 600ml. Industrieel model. Rond of plat regelbare straal. Diameter naald 1,4 of 2,0mm. Aparte regeling van druk en verfdiebt. Voor professioneel gebruik in industrie en automobielsector.

Order nr.	741761714 E		741761720 E	
Orig. nr.	VERF1071.4		VERF1072.0	
Werkdruk minimum	bar	3,5	3,5	
Luchtverbruik	l/min	300	300	
Sproeier	mm	-	-	
Capaciteit beker	l	0,6	0,6	
Prijs	€	79,00	82,00	



Accessoires voor VERF107 verfpistool.

Order nr.	741771400 E	741772000 E	741761001 E
Orig. nr.	VERFNK1.4	VERFNK2.0	VERF107C
Omschrijving	Naaldset 1,4 mm	Naaldset 2,0 mm	Bovenbeker voor VERF107
Prijs	€ 37,00	44,00	20,00



Verfpistool met onderbeker 1000ml. Industrieel model. Rond of plat regelbare straal. Diameter naald 1,8 of 2,5mm. Aparte regeling van druk en verfdiebt. Voor professioneel gebruik in industrie en automobielsector.

Order nr.	741791800 E		741792500 E	
Orig. nr.	VESJ101A1.8		VESJ101A25	
Werkdruk minimum	bar	3	3	
Luchtverbruik	l/min	175-300	175-300	
Sproeier	mm	1,8	2,5	
Capaciteit beker	l	1	1	
Prijs	€	83,90	84,90	



Accessoires voor VESJ101A verfpistool.

Order nr.	741801801 E	741802501 E	711803001 E
Orig. nr.	VESJN1K1.8	VESJN1K2.5	VESJNR1-8P
Omschrijving	Naaldset 1,8 mm	Naaldset 2,5 mm	Onderbeker met deksel
Prijs	€ 44,00	44,00	43,50

METALWORKS



Verfpistool met extern reservoir (10l) en aanvoerslangen van 3,5m. Rond of plat regelbare straal. Diameter naald 2,5mm. Aparte regeling van verfdebiet. Met manometer en ophanghaak.
Type VECH1001A: zonder wielen, geschikt voor solvent-verf.
Type VECH1002A: met wielen, geschikt voor én solvent-verf én voor verf op waterbasis.

Order nr.	741711001	741711002
Orig. nr.	VECH1001A	VECH1002A
Luchtverbruik	l/min 230-340	230-340
Sproeier	mm 2,5	2,5
Werkdruk minimum	kg/cm ² 4	4
Tankinhoud	l 10	10
Binnentank	metaal	teflon
Prijs	€ 259,00	305,00

Aircraft



Vernevelpistool. Met metalen spuitpijp en aluminium beker. Bajonetsluiting. Regelbaar spuitstuk en vloeistoftoevoer. Ergonomisch gebouwd. Traploze hendel. Met een 360° draaibare luchtkoppeling en ophanghaak.

Order nr.	712102200
Orig. nr.	2102200
Werkdruk	bar 4-6
Luchtverbruik	l/min +200
Prijs	€ 15,00

Aircraft



Regelbaar sproeipistool in aluminium voor het sproeien van reinigers, ontvetters, oliën. Volume, lucht- en vloeistofregelbaar.

Order nr.	712102220
Orig. nr.	2102220
Luchtverbruik	l/min 120-220
Werkdruk	bar 3-6
Prijs	€ 37,00

Schuurmachines

Aircraft



Composiet schuurmachines, vibratiearm en ergonomisch. Compact en gemakkelijk in gebruik voor vlakke en oneffen oppervlakken.

Order nr.	712403500	712403450	712403520
Orig. nr.	2403500	2403450	2403520
Toerental	tpm 11.000	10.000	8.500
Luchtverbruik 50% interval	l/min 480	350	360
Werkdruk maximum	bar 6,3	6,3	6,3
Verplaatsing	mm 3,2	5	3,2
Afmetingen schuurband	mm 70x95	150	100x180
Afzuigpaten	4	6	8
Prijs	€ 184,00	192,00	232,00

Slijpers

Aircraft



Bandslijper. 360° draaibare arm. Automatische opspanning van de band.

Order nr.	712403700	#TRE#
Orig. nr.	2403700	
Schuurbandafmetingen	mm 10x330	
Toerental	min-1 16.000	
Luchtverbruik	l 400	
Gewicht	kg 0,77	
Prijs	€ 129,00	

Aircraft



Terugtrekveer. Hulpveer voor herhaalveer zoals slijpen, boren of montagewerk. Verlicht het lastige werk via regelbare veer. Capaciteit 2 en 3kg op bestelling.

Order nr.	712106001
Orig. nr.	2106001
Belasting	kg 0,4-1,0
Lengte	m 1,6
Prijs	€ 46,00

aircraft[®] Drucklufttechnik

AIRCRAFT COMPRESSORS/COMPRESSED AIR TECHNIQUE

AIRCRAFT offers as a reliable partner:

- Excellent fitting and operator convenience
- High quality standard
- Strict production and final control
- Ideal price-performance ratio
- Future-oriented advancements

The Airprofi 603/50 was the only compressor which received the title 'top class' which was tested by magazin 'Heimwerker-Praxis'.



Compressors / compressed air technique

Piston compressor
Screw-type compressor
Compressed air spreading
Compressed air conditioning
Compressor implements
Accessories



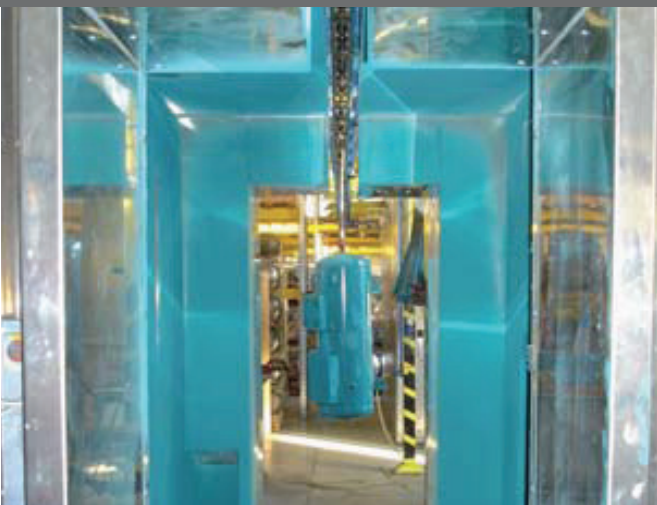

10 Gründe für Ihr Vertrauen - Die Vorteile bei AIRCRAFT® Drucklufttechnik

1 Die Produkte

Sie suchen nach funktionellen Kompressoren oder Druckluftwerkzeugen, die Ihnen umfassende Leistungsmerkmale mit optimalem Preis – Leistungsverhältnis bieten? Dann treffen Sie mit AIRCRAFT® die richtige Entscheidung. AIRCRAFT® Produkte bieten eine hervorragende Ausstattung, sind präzise verarbeitet und bieten ein Optimum an Preis und Leistung.

2 Die Qualität

Die Original AIRCRAFT® Produkte unterliegen unseren strengen Produktions- und Endkontrollen.

3 Ihre Wünsche sind unser Ziel

Seit 1992 beschäftigen wir uns mit der Entwicklung, der Konstruktion und der Produktion von AIRCRAFT® Produkten. Die Basis dafür sind unsere hochgesteckten Produktvorstellungen sowie die Wünsche unserer Kunden. AIRCRAFT® Produkte zeichnen sich durch Qualität, Langlebigkeit und Wertbeständigkeit aus.



4 Ihre Ansprechpartner

Ihnen steht ein flächendeckendes Netz von Fachhändlern und Vertriebspartnern mit Rat und Tat zur Verfügung. Sollten Sie Fragen haben, stehen Ihnen unsere Mitarbeiter und Vertriebspartner in jeder Hinsicht, telefonisch oder auch persönlich zur Verfügung.

5 Schnell und unkompliziert

Sollte Ihr Kompressor einmal ausfallen und nicht sofort repariert werden können, steht Ihnen bei vielen unserer Vertriebspartner ein Leihkompressor zur Verfügung.

6 Die dauerhafte Rostschutzgarantie

Als erster Hersteller liefern wir unser stationären Kompressoren sowie die gesamte AIRPROFI Serie ab der Seriennummer APZ mit feuerverzinkten Behältern aus. AIRCRAFT® gewährt bei diesen Kesseln 15 Jahre Garantie gegen Durchrostung.



7 After-sale-Service

Sollten Sie einmal Service benötigen, so steht Ihnen kein Abenteuer bevor. Ihr Fachhändler vor Ort, sowie unsere erfahrenen Servicekräfte, stehen Ihnen jederzeit zur Verfügung. Ein umfassendes Ersatzteillager in unserem Haus sichert Ihnen eine kurzfristige Ersatzteilversorgung im Bedarfsfall. Unser Service garantiert Ihnen auf Jahre die Wertsicherheit Ihrer Maschine.

8 Ersatzteile

Ersatzteile liefern wir in der Regel innerhalb eines Arbeitstages ab unserem Ersatzteillager.

9 Die Entsorgung

Ihr ausgedienter Kompressor wird von unseren Vertriebspartnern umweltgerecht entsorgt.

10 Unsere Zukunftsorientierung

AIRCRAFT® Produkte werden ständig zukunftsorientiert weiterentwickelt. Der Bau unserer neuen modernen Produktionsstätte dient ebenfalls dazu, auch weiterhin leistungsfähige Produkte zu wettbewerbsfähigen Preisen anbieten zu können.

Ihre Anwendungen sind unsere Herausforderung. Zusammen können wir Ihnen optimale Produkte bieten.





Direct aangedreven compressoren

Zaircraft



Handy 201 OF



Airboy 261 E



Airboy Silence 50 Pro

Handige draagbare compressoren voor dagelijks gebruik. Kwalitatieve elektromotoren met een hoog koppel. Thermische motorbeveiliging beschermt de motor tegen oververhitting. De ketel is gepoedergelakt. Volautomatische in- en uitschakeling van de compressor. Vibratiedempende zuignap-voetjes. Met een drukregelaar kan de gewenste werkdruk traploos vastgelegd worden. Gebouwd volgens de geldende CE-normen.

Handy 201. Olivrij model: geen olie in luchtdruk en condenswater en daardoor milieuvriendelijker.

Airboy Silence 50 Pro. Uitstekende compressor voor kleine werkjes zoals Airbrush spuiten. Uiterst geruisloos (slechts 43 dB(A) volgens DIN79/113EWG). Daardoor probleemloos te gebruiken in woningen en bureaus.

Airboy 261. Handige en draagbare compressor die uiterst compact is. met een miniketel van 2,4 liter en maximale druk van 10 Bar met hoogwaardige CONDOR drukschakelaar.

Order nr.		712001210 ^M	712001242 ^M	712001245 ^M	712000100 ^M
Orig. nr.		HANDY 201OF	AIRBOY 261	AIRBOY 261E	AIRBOY SILENCE50PRO
Spanning	V	230	230	230	230
Smeersysteem		WDS	HOS	HOS	gekapseld
Aangezogen lucht	l/min	179	260	260	50
Effectief afgegeven lucht	l/m @ 8 bar	110	170	170	33
Maximum druk	bar	8	10	10	8
Vermogen motor	kW	1,1	1,8	1,8	0,340
Tankinhoud	l	6	2,4	2,4	9
Cilinders/Trappen		1/1	1/1	1/1	1/1
Toerental	tpm	2850	2850	2850	2900
Geluidsniveau	dB(A) (4m)	91	97	79	43
Gewicht	kg	11,50	22,00	22,00	21,00
Afmetingen (l x b x h)	mm	330 x 255 x 500	510 x 270 x 400	510 x 270 x 400	320 x 320 x 480
Prijs	€	159,00	409,00	279,00	785,00



Mobilboy 221/24E

Compressor met 24l vat. Universeel inzetbaar. Een thermische motorbeveiliging beschermt de motor tegen oververhitting en overbelasting. Traploos instelbare werkdruk. Twee manometers voor tank- en werkdruk. De ketel is gepoederlakt. Volautomatische in- en uitschakeling. Olieloze pomp onderhoudsvrij. Gebouwd volgens de geldende CE-normen.

Order nr.	712002222 ^M	
Orig. nr.	MOBILBOY 221/24 OFE	
Spanning	V	230
Aangezogen lucht	l/min	200
Effectief afgegeven lucht	l/m @ 8 bar	110
Maximum druk	bar	8
Vermogen motor	kW	1,1
Tankinhoud	l	24
Geluidsniveau	dB(A) (1m)	78
Gewicht	kg	24,00
Prijs	€	174,00



Mobilboy 241/24E



Mobilboy 311/50E

Compressor met 24l of 50l vat. Universeel inzetbaar voor de doe-het-zelver. Traploos instelbare werkdruk. Twee manometers voor tank- en werkdruk. De ketel is gepoederlakt. Volautomatische in- en uitschakeling. Een thermische motorbeveiliging beschermt de motor tegen oververhitting en overbelasting. Oliegesmeerde pomp. Gebouwd volgens de geldende CE-normen.

Order nr.	712002241 ^M		712003331 ^M	
Orig. nr.	MOBILBOY 241/24 E		MOBILBOY 311/50E	
Spanning	V	230	230	
Smeersysteem		HOS	HOS	
Aangezogen lucht	l/min	200	284	
Effectief afgegeven lucht	l/m @ 8 bar	102	190	
Maximum druk	bar	8	8	
Vermogen motor	kW	1,8	2,2	
Tankinhoud	l	24	50	
Cilinders/Trappen		1/1	1/1	
Toerental	tpm	2850	2850	
Geluidsniveau	dB(A) (4m)	93	99	
Gewicht	kg	23,00	36,50	
Afmetingen (l x b x h)	mm	570 x 255 x 590	870 x 350 x 700	
Prijs	€	159,00	359,00	



NEW

Compressor met 50l vat. Oligesmeerde pomp. Groot debiet door dubbele cilinder in V-stand. Traploos instelbare werkdruk. Twee manometers voor tank- en werkdruk. De ketel is gepoederlakt. Volautomatische in- en uitschakeling. Een thermische motorbeveiliging beschermt de motor tegen oververhitting en overbelasting. Gebouwd volgens de geldende CE-normen.

Order nr.		712003650 M
Orig. nr.		MOBILBOY 361/50 E
Spanning	V	230
Smeersysteem		HOS
Aangezogen lucht	l/min	356
Effectief afgegeven lucht	l/m @ 8 bar	215
Maximum druk	bar	10
Vermogen motor	kW	2,2
Tankinhoud	l	50
Cilinders/Trappen		2/1
Toerental	tpm	2850
Geluidsniveau	dB(A) (1m)	79
Gewicht	kg	38,00
Afmetingen (l x b x h)	mm	870 x 350 x 700
Prijs	€	369,00



Zeer compacte en mobiele werfcompressor. Oligesmeerde. Sterk frame beschermt alle componenten. Licht en gemakkelijk draagbaar. Elektromotor met hoog koppel en overbelastingsschakelaar. Volautomatische in- en uitschakeling. Kunststof banden en zuignappen vooraan. Met drukregelaar, 2 manometers en snelkoppeling. Gepoederlakt. Compleet en aansluitklaar geleverd. Standaard uitgerust met alle veiligheidsvoorzieningen. Gebouwd volgens de geldende CE-normen.

Order nr.		712005261 M
Orig. nr.		COMPACT-AIR 265/10 E
Spanning	V	230
Smeersysteem		HOS
Aangezogen lucht	l/min	250
Effectief afgegeven lucht	l/m @ 8 bar	155
Maximum druk	bar	10
Vermogen motor	kW	1,5
Tankinhoud	l	9,5
Cilinders/Trappen		1/1
Toerental	tpm	2850
Geluidsniveau	dB(A) (1m)	76
Gewicht	kg	22,00
Afmetingen (l x b x h)	mm	395 x 320 x 630
Prijs	€	279,00

COMPACTE WERFCOMPRESSOR

Compacte mobiele compressor, ideaal voor gebruik in bestelwagens of op werven. Kwaliteits-elektromotor met een hoog koppel wordt door een overbelastingsschakelaar beschermd. Oliegesmeerde. Automatisch in- en uitschakelen. Breekbare elementen zitten goed afgeschermd door een stalen frame. Voorzien van 2-cilinder compressorkop voor een rustige loop met gereduceerde vibraties. compleet gepoederlakt en aansluitklaar geleverd. Standaard uitgerust met alle veiligheidsvoorzieningen. CE-conform.



Order nr.	712005291 ^M	
Orig. nr.	COMPACT-AIR 311/20E	
Spanning	V	230
Smeersysteem		HOS
Aangezogen lucht	l/min	284
Effectief afgegeven lucht	l/m @ 8 bar	190
Maximum druk	bar	10
Vermogen motor	kW	2,2
Tankinhoud	l	20
Cilinders/Trappen		1/1
Toerental	tpm	2850
Geluidsniveau	dB(A)	94
Gewicht	kg	33,50
Afmetingen (l x b x h)	mm	470 x 490 x 720
Prijs	€	399,00

NEW
GROOT DEBIT

Compacte en mobiele werfcompressor. Sterk frame beschermt alle componenten. Hoog debiet door dubbele V-cilinder. Elektromotor met hoog koppel en overbelastingsschakelaar. Volautomatische in- en uitschakeling. Kunststof banden en zuignappen vooraan. Met drukregelaar, 2 manometers en 2 snelkoppelingen. Gepoederlakt. Compleet en aansluitklaar geleverd. Standaard uitgerust met alle veiligheidsvoorzieningen. Gebouwd volgens de geldende CE-normen.



Order nr.	712005361 ^M	
Orig. nr.	COMPACT-AIR 361/20 E	
Spanning	V	230
Smeersysteem		HOS
Aangezogen lucht	l/min	356
Effectief afgegeven lucht	l/m @ 8 bar	215
Maximum druk	bar	10
Vermogen motor	kW	2,2
Tankinhoud	l	20
Cilinders/Trappen		2/1
Toerental	tpm	2850
Geluidsniveau	dB(A) (1m)	79
Gewicht	kg	37,00
Afmetingen (l x b x h)	mm	470 x 490 x 720
Prijs	€	439,00

1

Hoogwaardige pomp met HOS-smering

- De gietijzeren hoogwaardige tweecilinder aggregaat in combinatie met het lage toerental zorgt voor een hoge bedrijfszekerheid en een lange levensduur.
- De nakoeler met grote koellamellen zorgt voor een lage ingangstemperatuur aan de ketel.

HOS



2

- **Kwaliteitselektromotor** met motorbeveiliging tegen oververhitting en overbelasting beschermd.
- Condensator en ontlastingsventiel verzekeren een zachte aanloop op de 230 V modellen.



3

Aansluiting

- Aansluitingskabel met stekker.
- 400V modellen met fasen omvormer voor gemakkelijke handmatige omkering van de draairichting.

4

- **Verdeelbox** met schroefverbindingen
- De werkdruk is traploos instelbaar aan de filter drukregelaar, met simultane afscheiding van vuil, olie en condensaat.
- 2 grote manometers tonen de werkdruk en de druk in de ketel aan.
- Standaard uitgerust met veiligheidsnauwkeppelingen, met één hand te bedienen.
- Standaard uitgerust met een hoogwaardige CONDOR drukregelaar.



5

- Lange hendel voor gemakkelijk rechtop verplaatsen van de compressor.
- Geen belasting van de rug door optillen.

6

- De rubberen handgreep voorkomt wegglijden.

7

- Comfortabel transport dankzij zwenkwielen met rem.
- De rem voorkomt de draai- en rolbewegingen van de wielen, voor een optimale stabiliteit van de compressor.

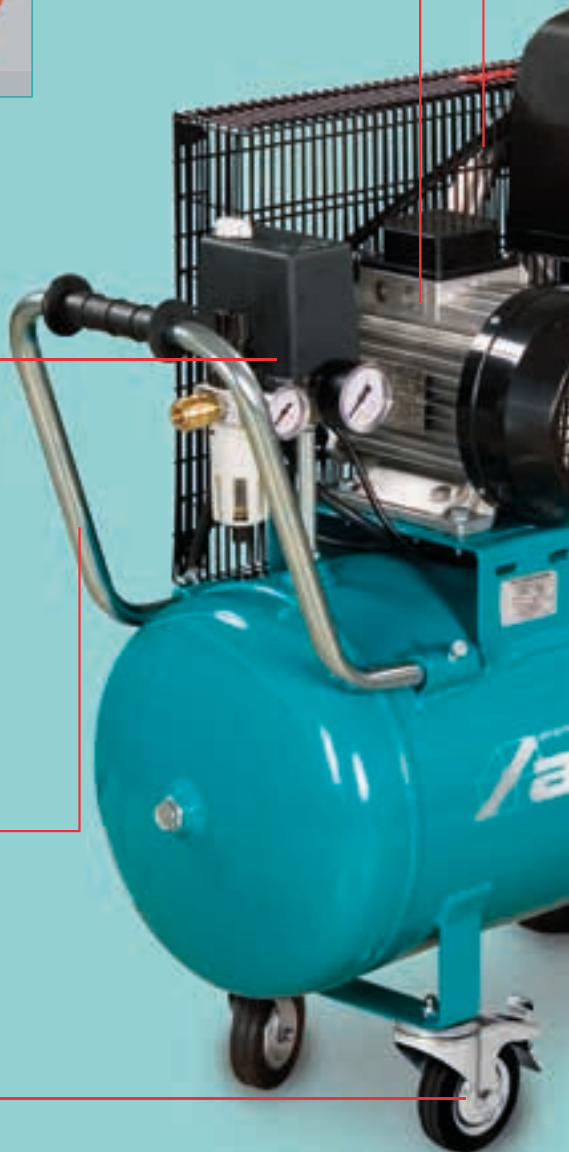

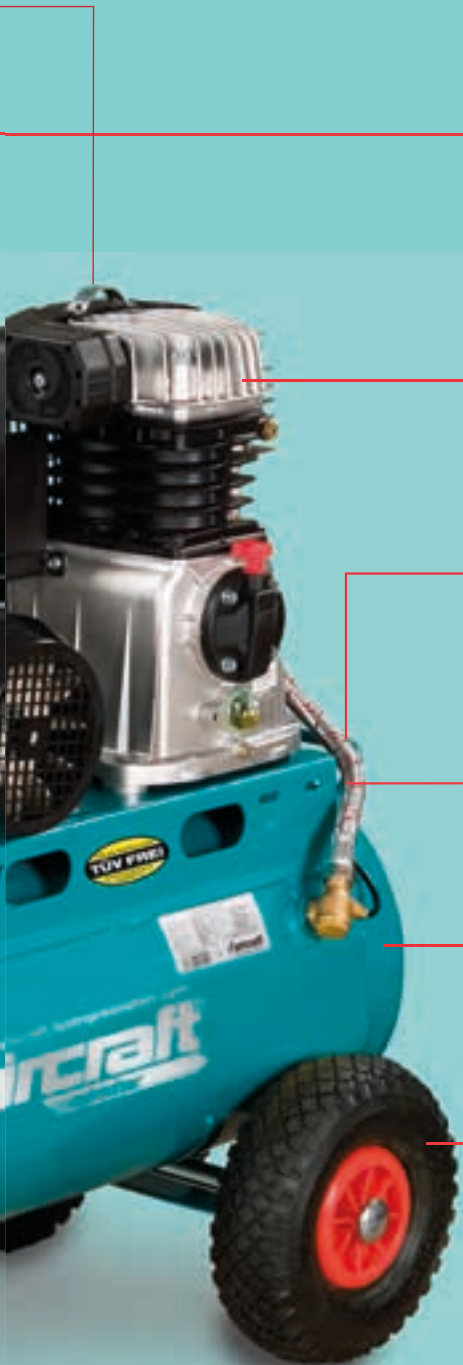

8

• **Krachtige en zuinige aandrijving**

- Getande aandrijfriem voor een eenvoudig opstarten, rustigere loop en betere krachtoverbrenging, en vermindert opbrengstverliezen tot 30%.



9

- De grote ventilator en koelribben op de cilinder zorgen voor een optimale koeling van de pomp.

- Het metalen riemdekseel zorgt voor een optimale bescherming van de componenten en voor de veiligheid van de gebruiker.

10

- Roestvrije platen aan het ontlastingsventiel voor een betere warmteafvoer en een lange levensduur van de compressor.



11

- **Handig transportgreep op de ketel.**



12

- Gepantserde flexibele slang met bescherming tegen de hitte voor een lange levensduur, zodat geen breuk door vibraties mogelijk is.
- De terugslagklep zorgt voor een zachte aanloop.

13

- Hoogwaardige gepoederlakte ketel voor een lange levensduur.
- Beschikbaar in 50, 100 en 200 liter.

14

- De grote volle wielen met PU-schuim en de rem zorgen voor een comfortabel transport, omdat de compressor niet opgetild moet worden.



Riemaangedreven compressoren



Airstar 321/50E

Mobiele compressor met riemaandrijving en 2-cilinder luchtaggregate met gietijzer koelribben. Elektromotor met overbelastingsschakelaar. Nakoeler met grote koellamellen. Flexibele, gepantserde en hittebestendige slangleiding. Kunststof banden en zuignappen vooraan. Met drukregelaar, 2 manometers en snelkoppeling. Volautomatische in- en uitschakeling. Gepoederlakte ketel. Compleet aansluitklaar geleverd. Standaard uitgerust met alle veiligheidsvoorzieningen. Gebouwd volgens de geldende CE-normen.



Order nr.		712008312 ^M	712009414 ^M
Orig. nr.		AIRSTAR 321/50 E	AIRSTAR401/90E
Spanning	V	230	230
Smeersysteem		HOS	HOS
Aangezogen lucht	l/min	235	365
Effectief afgegeven lucht	l/m @ 8 bar	185	266
Maximum druk	bar	10	10
Vermogen motor	kW	1,5	2,2
Tankinhoud	l	50	100
Cilinders/Trappen		2/1	2/1
Toerental	tpm	1040	1375
Geluidsniveau	dB(A) (1m)	76	94
Gewicht	kg	48,50	1,00
Afmetingen (l x b x h)	mm	870 x 400 x 700	870 x 500 x 780
Prijs	€	409,00	589,00



Airstar 401/100

Mobiele compressoren met riemaandrijving en een hoogwaardig 2-cilinder luchtaggregate met gietijzer koelribben. Elektromotor met hoog koppel en overbelastingsschakelaar. Nakoeler met grote koellamellen. Flexibele, gepantserde en hittebestendige slangleiding is bestand tegen vibratiebreuken. Grote stabiele PU-gevulde banden en draaiwielen. Met filterdrukregelaar, manometer en industriële RECTUS snelkoppeling. Volautomatische in- en uitschakeling via CONDORSchakelaar. Gepoederlakte ketel. Compleet aansluitklaar geleverd. Standaard uitgerust met alle veiligheidsvoorzieningen. CE-conform.

Order nr.		712009410 ^M	712007411 ^M	712007421 ^M	712009432 ^M
Orig. nr.		AIRSTAR 401/50	AIRSTAR 401/100	AIRSTAR 401/200	AIRSTAR 403/200F
Spanning	V	230	230	230	3x400
Smeersysteem		HOS	HOS	HOS	HOS
Aangezogen lucht	l/min	390	390	390	390
Effectief afgegeven lucht	l/m @ 8 bar	285	285	285	285
Maximum druk	bar	10	10	10	10
Vermogen motor	kW	2,2	2,2	2,2	2,2
Tankinhoud	l	50	100	200	200
Cilinders/Trappen		2/1	2/1	2/1	2/1
Toerental	tpm	1490	1490	1490	1490
Geluidsniveau	dB(A) (4m)	96	96	96	96
Gewicht	kg	57,50	69,00	94,00	57,50
Afmetingen (l x b x h)	mm	870 x 400 x 700	1080 x 500 x 780		
Prijs	€	709,00	749,00	989,00	1.019,00



RECTUS driefasige compressoren voor de veeleisende professional. Betrouwbare riemaandrijving en hoogwaardig 2-cilinder luchttaggregaat met gietijzer koelribben. Groot debiet. Kwaliteits-elektromotor met hoog koppel en overbelastingsschakelaar. Grote koellamellen. Flexibele, gepantserde en hittebestendige slangleiding is bestand tegen vibratiebreuken. Grote volle banden. Met filterdrukregelaar, manometer en snelkoppeling. Volautomatische in- en uitschakeling van de compressor met CONDOR-schakelaar. Gepoederlakte ketel. Compleet aansluitklaar geleverd. Standaard uitgerust met alle veiligheidsvoorzieningen. Gebouwd volgens de geldende CE-normen. Met CONDOR schakelaar en snelkoppeling RECTUS.



Airstar 503

Order nr.		712009531 ^M	712007623 ^M	712009731 ^M
Orig. nr.		AIRSTAR 503/100	AIRSTAR 503/200	AIRSTAR 703/100 F
Spanning	V	3x400	3x400	230
Smeersysteem		HOS	HOS	HOS
Aangezogen lucht	l/min	510	510	650
Effectief afgegeven lucht	l/m @ 8 bar	400	400	520
Maximum druk	bar	10	10	10
Vermogen motor	kW	3,0	3,0	4
Tankinhoud	l	100	200	100
Cilinders/Trappen		2/1	2/1	2/2
Toerental	tpm	1310	1310	950
Geluidsniveau	dB(A) (4m)	94	94	
Gewicht	kg	65,00	65,00	65,00
Afmetingen (l x b x h)	mm	1070 x 480 x 870	1180 x 600 x 900	1080 x 500 x 970
Prijs	€	969,00	1.139,00	1.349,00



Compact-AIR BX 240 OF Silent - onderhoudsarme montagecompressor met olievrije pomp en hoge prestaties voor professioneel gebruik.

Ideaal voor vaklui onderweg of op bouwerven. Ook geschikt als compacte werkplaatscompressor. Ideaal indien zuivere lucht vereist is of als in lage temperaturen wordt gewerkt. Groot luchtdebiet, bestemd voor continu gebruik door lage opwarming. Gepatenteerde olievrije pomp werkt met horizontale zuigers zoals een boxermotor en vermindert slijtage. Olivrij, onderhoudsarm en met lange levensduur. Geluidsarme en rustige loop door laag toerental. Kwaliteits-elektromotor met zachte aanloop en thermische veiligheid. Automatisch aan- en uitschakelen.

Geleverd met kwalitatieve EURO-snelkoppelingen, CONDOR drukschakelaar en 2 manometers. Grote luchtbanden en brede wielbasis garanderen stabiliteit en veilig transport. Gepoederlakte ketel



Order nr.		712005310 ^M
Orig. nr.		2005310
Spanning	V	230
Smeersysteem		HDS
Aangezogen lucht	l/min	240
Effectief afgegeven lucht	l/m @ 8 bar	150
Maximum druk	bar	10
Vermogen motor	kW	1,5
Tankinhoud	l	24
Toerental	tpm	1400
Geluidsniveau	dB(A)	78
Cilinders/Trappen		2/1
Gewicht	kg	34,00
Afmetingen (l x b x h)	mm	500 x 560 x 810
Prijs	€	939,00

1

- Uitgerust met een **CONDOR drukregelaar**.
- Volautomatische in- en uitschakeling.

2

Energiebesparing: 8 bar in plaats van 10!

- Om energieverpilling te vermijden, hebben we voor u de uitschakeldruk verlaagd.
- Indien nodig kunt u op elk ogenblik de druk zelf verhogen tot 10 bar.



3

- Lange hendel voor gemakkelijk rechtop verplaatsen van de compressor.
- Geen belasting van de rug door optillen.

4

- De **rubberen handgreep** voorkomt wegglijden.

5

- De **kwaliteitselektromotor** wordt door een motorbeveiliging tegen oververhitting en overbelasting beschermd.

6

- **3x400 V modellen** met fasen wisselaar voor gemakkelijke handmatige omkering van de draairichting.



7

- **Verdeelbox** met schroefverbindingen
- De werkdruk is traploos instelbaar aan de filter drukregelaar, met simultane afscheiding van vuil, olie en condensaat.
- 2 grote manometers tonen de werkdruk en de druk in de ketel aan.
- Twee aftakpunten voor gefilterde lucht, gefilterde en geoliede lucht en een aftakpunt direct op de ketel.
- Standaard uitgerust met **veiligheids-snelkoppelingen**, met een hand te bedienen.



8

- Voor uw veiligheid voorziet AIRCRAFT als enige fabrikant zijn AIRPROFI compressoren standaard met veiligheidssnelkoppelingen, met één hand te bedienen.
- Dankzij de ontluichtingstechniek met twee afzonderlijke vergrendelssystemen wordt het systeem drukloos gekoppeld, wat de terugslag van de slang bij het loskoppelen voorkomt. Uw voordeel: een aanzienlijke verbetering van de veiligheid van de gebruiker.



9

- Derde aftakpunt direct op de ketel, met kogelkraan.

10

- Comfortabel transport dankzij zwenkwielen met rem.
- De rem voorkomt de draai- en rolbewegingen van de wielen, voor een optimale stabiliteit van de compressor.

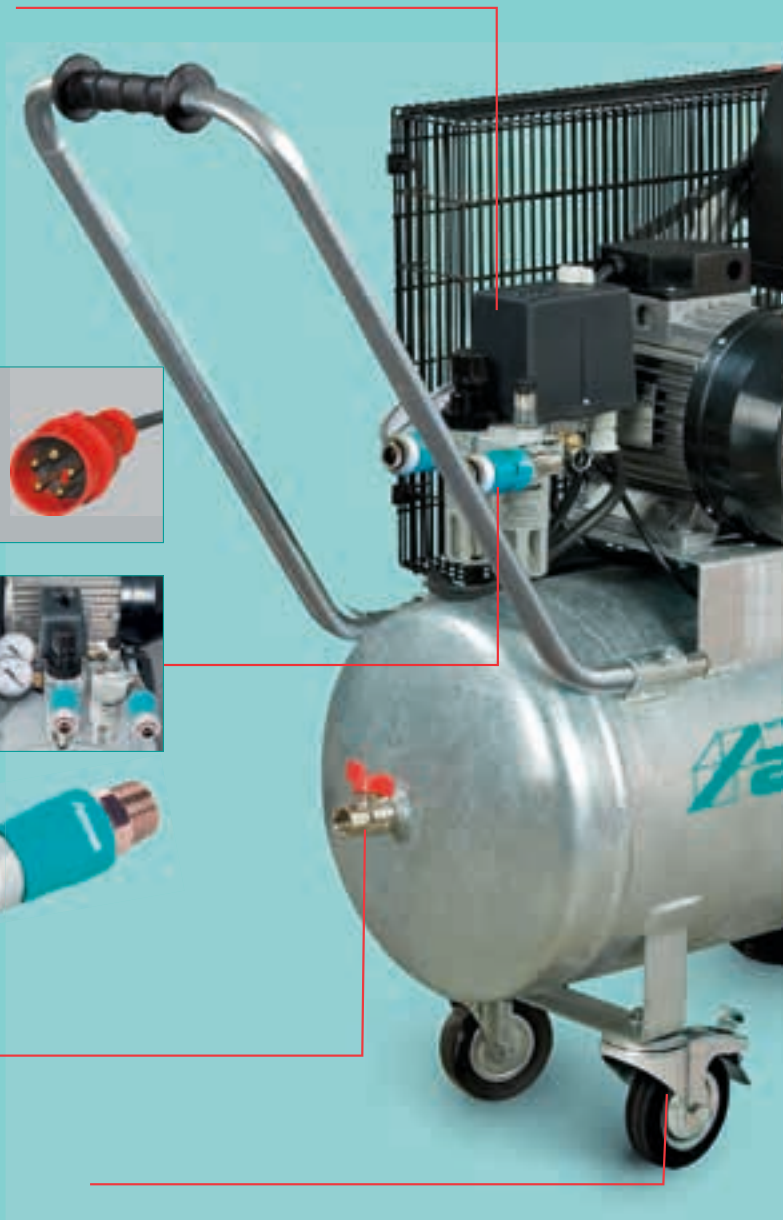



11

- **Krachtige en zuinige aandrijving**
- Getande aandrijfriem voor een eenvoudig opstarten, rustigere loop en betere krachtoverbrenging, en vermindert opbrengstverliezen tot 30%.



12

- De grote ventilator diameter en koelribben op de cilinder zorgen voor een optimale koeling van de pomp.
- Het metalen riemdekseel zorgt voor een optimale bescherming van de componenten en voor de veiligheid van de gebruiker.



13

- Roestrijke platen aan het ontlastingsventiel voor een betere warmteafvoer en een lange levensduur van de compressor.

HOS



14

- De **gietijzeren hoogwaardige** tweecilinder pomp met het lage toerental zorgt voor een hoge bedrijfszekerheid en een lange levensduur.
- Het HOS systeem verzekert een optimale smering voor een hoge bedrijfszekerheid en een lange levensduur.
- De nakoeler met grote koellamellen zorgt voor een lage ingangstemperatuur aan de ketel, en daarmee voor een lager vochtgehalte, wat het luchtdrukgereedschap ten goede komt.

15

- Gepantserde flexibele slang met bescherming tegen de hitte voor een lange levensduur, zodat breuk door vibraties onmogelijk is.
- De terugslagklep zorgt voor een zachte aanloop.

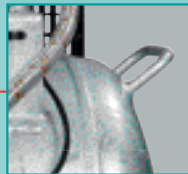

16

- **Handig transportgreep op de ketel.**

17

- AIRPROFI verzinkte compressoren garanderen een duurzame bescherming tegen roest.
- AIRCRAFT is de eerste fabrikant die zijn AIRPROFI compressoren standaard uitrust met een verzinkte ketel, zowel binnen als buiten.
- Bij de AIRPROFI serie krijgt u 15 jaar garantie tegen doorroesten van de ketel.

18

- De grote volle wielen met PU-schuim en de rem zorgen voor een comfortabel transport, omdat de compressor niet opgetild moet worden.



OPROEGASPEL
p.406



Aircraft

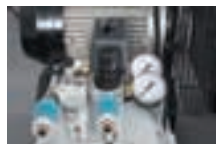

Professionele montagecompressor met verzinkte tank voor de veeleisende gebruiker.

Kwaliteitselektromotor met een hoog koppel wordt door een overbelastingsschakelaar beschermd tegen oververhitting en overbelasting.

- 3x400V met fasewisselknop in de stekker.

- Hoogwaardige CONDOR drukschakelaar voor volautomatische in- en uitschakeling.

- Verdeelblok met drukregelaar en 2 grote manometers voor druk op het vat en op de uitgangen.

- 2 aftakpunten met gefilterde lucht en al dan niet geolieerde lucht.

- 2 EURO veiligheids-snelkoppelingen voor het drukloos ontkoppelen van gereedschappen.

- Met aftakkraan aan de ketel.

- Mobiele met grote stabiele PU-schuimgevulde banden en rubber handgreep.

- Betrouwbare riemaandrijving en een hoogwaardige 2-cilinder luchtaggregate vervaardigd uit aluminium/gietijzer.

- De Nakoeler met grote koellamellen. Flexibele, gepantere en hittebestendige slangleiding is bestand tegen vibratiebreuken.

- Compleet aansluitklaar geleverd. Standaard uitgerust met alle veiligheidsvoorzieningen. Gebouwd volgens de geldende CE-normen.



Airprofi 503

MACHINES

Order nr.		712018531 ^M	712018731 ^M
Orig. nr.		AIRPROFI 503/100	AIRPROFI 703/100
Spanning	V	3x400	3x400
Smeersysteem		HOS	HOS
Aangezogen lucht	l/min	510	650
Effectief afgegeven lucht	l/m @ 8 bar	400	520
Maximum druk	bar	10	10
Vermogen motor	kW	3,0	4
Tankinhoud	l	100	100
Cilinders/Trappen		2/1	2/2
Toerental	tpm	1310	950
Geluidsniveau	dB(A) (4m)	96	93
Gewicht	kg	76,00	99,00
Afmetingen (l x b x h)	mm	1080 x 500 x 940	1120 x 480 x 960
Prijs	€	1.109,00	1.479,00

De Aircraft compressoren: pompsystemen

WDS - olieloos

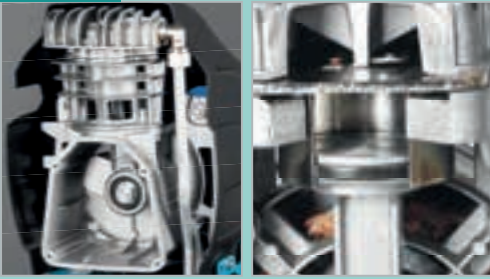

WDS-olieoze smering.

- Een zuigerring uit Teflon neemt bij WDS systeem de taak over van de normale zuigerring uit staal.
- Een smering met mineraalolie is niet meer nodig.

Voordelen van het WDS systeem.

- Oliewissel en -controle vallen weg.
- Gunstige oplossing door een beperkt aantal eenvoudige onderdelen.
- Ideale oplossing bij kleine behoefte aan luchtdruk.

HDS - olieloos

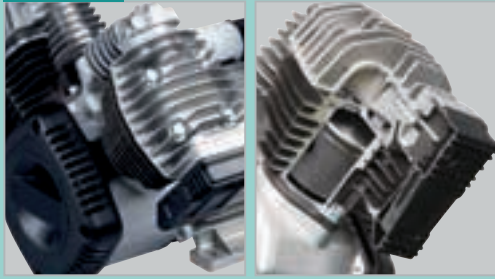

HDS - Hoog performant, olieloos smeersysteem

- Ontworpen voor continu gebruik, telkens als schone en olievrije perslucht nodig is.
- Grote zuiger op beweegbare lager gemonteerd, biedt tot 60% meer vermogen in vergelijking met systemen met oscillerende zuiger.
- Zeer precieze en gladde zuigeroppervlakken voor minimale wrijving.
- Hoogwaardige zuiger en zuigerring uit speciale legering van grafiet, Teflon en koolstof voor een langere levensduur dan een gewone Teflon zuigerring.

Voordelen van het HDS systeem.

- Levensduur tot 50 keer langer in vergelijking met gewone onderhoudsvrije systemen met oscillerende zuiger.
- De grote koellamellen in combinatie met de zuiger uit een stuk vervaardigd zorgen voor een optimale warmteafvoer.
- Onderhoudsvrij.
- Ideaal overal waar schone en olievrije perslucht nodig is in dagelijks gebruik.

HOS



HOS - Het systeem met oliesmering voor zware bedrijfsomstandigheden.

De precies afgewerkte zuigers zijn voorzien van 2 dichtingen die de zuigerwand perfect afdichten. Het carter is gevuld met olie en de smering gebeurt door de olie die wordt rondgeworpen door de slag van de cilinder/krukas. Een afdichting/schraper veegt de geoliede zuigerwand af naar onder.

De voordelen van het HOS systeem:

- Perfecte smering en een optimale afdichting.
- Hoge bedrijfszekerheid en lange levensduur.
- Zeer onderhoudsvriendelijk. De ideale compressor voor het zware professionele gebruik.

HDS *Modell BX*



NEW
Gepatenteerde
Techniek

HDS - Hoog performant, olieloos smeersysteem

- Ontworpen voor continu gebruik, telkens als schone en olievrije perslucht nodig is.
- Grote zuiger op beweegbare lager gemonteerd, biedt tot 60% meer vermogen in vergelijking met systemen met oscillerende zuiger.
- Op het BX model heeft de zuiger een axiale beweging, zoals een boxermotor – gepatenteerde technologie voor een aanzienlijke vermindering van slijtage (zie afbeelding).
- De zuiger heeft een axiale beweging in een speciale cilinder met keramische coating.
- Dit vermindert aanzienlijk de slijtage van de afdichtingen.
- Dit systeem voorkomt frequent en kostbaar onderhoud dat noodzakelijk is op conventionele droge compressoren.

Voordelen van het smeersysteem « HDS » BX

- De gepatenteerde olievrije compressor met dubbele zuiger en de horizontale compressie, vermindert de slijtage aanzienlijk in vergelijking met de conventionele olievrije compressoren.
- De grote koellamellen in combinatie met de zuiger uit een stuk vervaardigd zorgen voor een optimale warmteafvoer.
- Onderhoudsvrij.
- Ideaal overal waar schone en olievrije perslucht nodig is in dagelijks gebruik.



Stationaire compressoren



Airstar 703/270H



Airstar 703/270 V

Stationaire driefasige compressor met gepoederlakte ketel, model 270V met een plaatsbesparende verticale ketel van 270 liter. Model 270H met horizontale ketel van 270 liter. Hoge prestaties op een kleine oppervlakte, ontwikkeld voor intensief gebruik. Tweecilinderige compressorkop uit gietijzer met rustige loop. Grote koellamellen en vliegwiel. Hoogwaardig filterpatroon zorgt voor zuivere aanzuiglucht. Kwaliteitselektromotor met overbelastingsschakelaar. 3 luchtafname-uitgangen op de ketel met CONDER drukschakelaar. Gebouwd volgens de geldende CE-normen.

Order nr.		712028753	712028752
Orig. nr.		AIRSTAR 703/270 H	AIRSTAR 703/270 V
Spanning	V	3x400	3x400
Smeersysteem		HOS	HOS
Aangezogen lucht	l/min	650	650
Effectief afgegeven lucht	l/m @ 8 bar	520	520
Maximum druk	bar	10	10
Vermogen motor	kW	4	4
Tankinhoud	l	270	270
Cilinders/Trappen		2/2	2/2
Toerental	tpm	920	920
Geluidsniveau	dB(A) (1m)	80	80
Gewicht	kg	117,00	117,00
Afmetingen (l x b x h)	mm	1950 x 600 x 1250	1950 x 600 x 1250
Prijs	€	1.495,00	1.869,00



Airprofi 853/270/10 V

Stationaire driefasige compressoren verzinketekel met lange levensduur. Deze V-modellen zijn uitgerust met een plaatsbesparende verticale ketel van 270 liter. Hoge prestaties op een kleine oppervlakte, ontwikkeld voor intensief gebruik. Tweecilinderige compressorkop uit gietijzer met rustige loop. Grote koellamellen en vliegwiel. Hoogwaardig filterpatroon zorgt voor zuivere aanzuiglucht. Kwaliteitselektromotor met overbelastingsschakelaar. 3 luchtafname-uitgangen op de ketel. Verzinkte ketel. CONDOR drukschakelaar. Aansluitklaar geleverd. Optioneel leverbaar met koeldroger en condensafleider.

Order nr.		712024712	712024812
Orig. nr.		AIRPROFI 703/270/10V	AIRPROFI 853/270/10V
Spanning	V	3x400	3x400
Smeersysteem		HOS	HOS
Aangezogen lucht	l/min	650	850
Effectief afgegeven lucht	l/m @ 8 bar	520	680
Maximum druk	bar	10	10
Vermogen motor	kW	4	5,5
Tankinhoud	l	270	270
Cilinders/Trappen		2/2	2/2
Toerental	tpm	950	1240
Geluidsniveau	dB(A)	83	83
Gewicht	kg	160,00	170,00
Afmetingen (l x b x h)	mm	850 x 830 x 1820	850 x 830 x 1820
Prijs	€	2.129,00	2.339,00



Stationaire compressoren. Met horizontaal groot 300 of 500L verzinkt drukvat. Betrouwbare riemaandrijving en hoogwaardig 2-cilinder luchtaggregate uit gietijzer. Twee-traps compressor met laag toerental, voor een geluidsarme werking en lange levensduur. Tussen- en nakoeler met grote koellamellen. Kwaliteits elektromotor met hoog koppel met overbelastingsschakelaar. Flexibele gepantserde slangleiding hittebestendig tegen vibratiebreuken. Volautomatische in- en uitschakeling van de compressor met CONDOR drukschakelaar. De ketel is gegalvaniseerd. Compleet aansluitklaar geleverd. Standaard uitgerust met alle veiligheidsvoorzieningen. Gebouwd volgens de geldende CE-normen.



Airprofi 853/500/10H

Order nr.		712025713 ^M	712025813 ^M	712025815 ^M
Orig. nr.		AIRPROFI 703/300/10H	AIRPROFI 853/300/10H	AIRPROFI853/500/10H
Spanning	V	3x400	3x400	3x400
Smeersysteem		HOS	HOS	HOS
Aangezogen lucht	l/min	650	850	850
Effectief afgegeven lucht	l/m @ 8 bar	520	680	680
Maximum druk	bar	10	10	10
Vermogen motor	kW	4,0	5,5	5,5
Tankinhoud	l	300	300	500
Cilinders/Trappen		2/2	2/2	2/2
Toerental	tpm	950	1240	1240
Geluidsniveau	dB(A) (4m)	83	83	83
Gewicht	kg	190,00	195,00	285,00
Afmetingen (l x b x h)	mm	1680 x 540 x 1130	1680 x 540 x 1130	2000 x 600 x 1250
Prijs	€	2.159,00	2.269,00	2.569,00



Zware werfcompressor met hoog debiet.

Uiterst performante bouwcompressoren voor krachtige, dagdagelijkse prestaties. Ideaal voor bouwerven of verplaatsbare werkplaatscompressor. Groot lichtdebiet, bestemd voor continu gebruik. Robuust frame met werkvlak bovenaan. Rustige loop door laag toerental garanderen lange levensduur. Kwaliteits elektromotor met zachte aanloop en thermische veiligheid. Automatisch aan- en uitschakelen. 3 veiligheids EURO-snelkoppelingen. 3 aftappunten: 1x gefilterd, 1x gefilterd en geluid, 1x ongefilterd vanuit het drukvat. met CONDOR drukschakelaar, 2 manometers, luchtfilter en olieverevelaar. Grote PU-schuimbanden voorkomen lekke band. Brede wielbasis garandeert stabiliteit en veilig transport. Gepoederlakte ketel. Gepantserde drukleidingen voorkomen verbranding en breuk door vibratie. Groot gebruiksgemak: PU-schuimbanden, 2 handgrepen, kabel en slanhaken in het frame en overzichtelijk bedieningspaneel.



Order nr.		712005531 ^M	712005553 ^M
Orig. nr.		321/22PRO	553/22PRO
Spanning	V	230	3x400
Smeersysteem		HOS	HOS
Aangezogen lucht	l/min	310	550
Effectief afgegeven lucht	l/m @ 8 bar	240	410
Maximum druk	bar	10	10
Vermogen motor	kW	2,2	3
Tankinhoud	l	2x11	2x11
Cilinders/Trappen		2/1	2/1
Toerental	tpm	1420	1420
Geluidsniveau	dB(A)	91	94
Gewicht	kg	53,00	77,00
Afmetingen (l x b x h)	mm	780 x 685 x 670	780 x 685 x 670
Prijs	€	1.159,00	1.649,00

Aircraft schroefcompressoren

Innovatie, kwaliteit en zuinigheid – Onze prioriteiten !

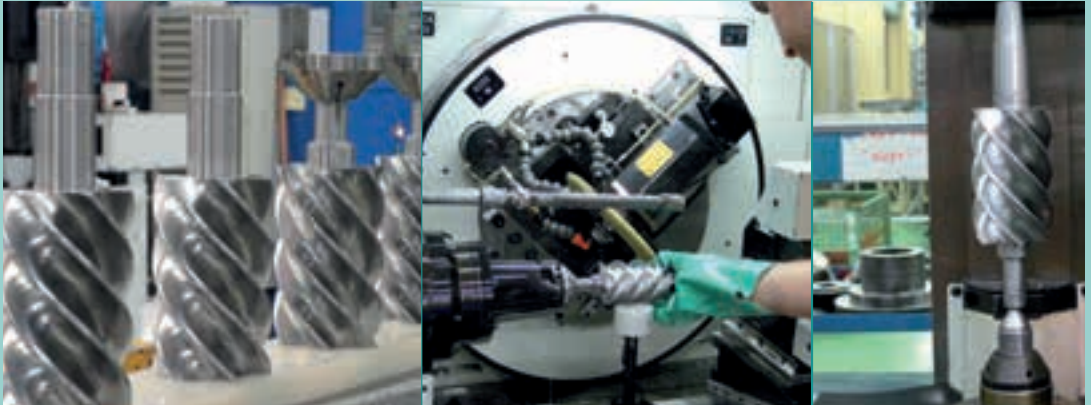

De Aircraft voordelen:

- Toonaangevende kwaliteit sinds meer dan 20 jaar
- Maximale nauwkeurigheid
- Permanente 100% productiecontrole
- Uniek ReVerso schroefprofiel
- Betrouwbare en efficiënte oplossingen



Meer info:

- Consulteer onze website
- Contacteer onze binnendienst

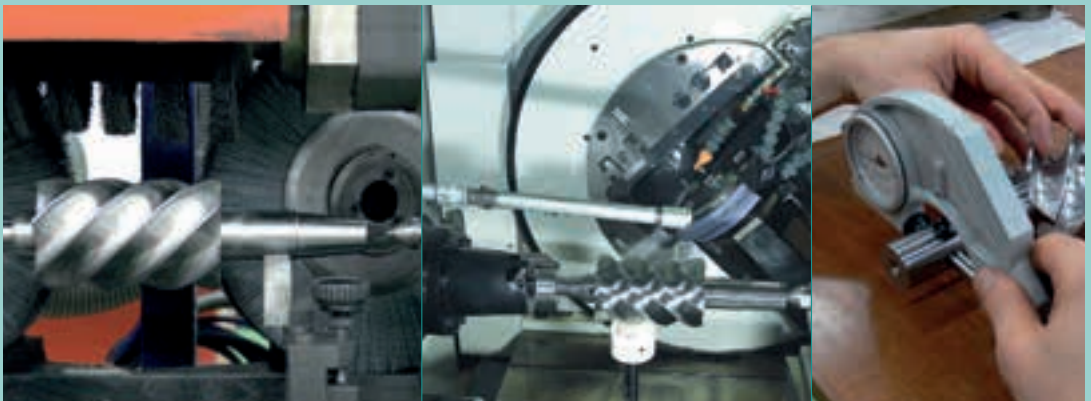

Schroefcompressoren

aircraft

Plaatsbesparende schroefcompressoren voor industriële toepassingen.

- de voordelen van een schroefcompressor op kleine oppervlakte, ideaal voor kleine afnemers.
- onderhouds- en gebruiksvriendelijk
- standaard een zeer geluidsarme werking (63 dB(A))
- intensieve koeling, samen met de efficiënte nakoeler garanderen uitstekende luchtkwaliteit en bedrijfszekerheid.
- ontwikkeld voor industriële toepassingen
- inzetbaar als inbouwcompressor bij pneumatische machines of installaties (bv plaatscharen, persen, ...)
- vuurverzinkte ketel beschermd tegen doorroesten (15 jaar garantie).



A-RSD Compact 4/90-10

Order nr.		712070601 ^M	712070801 ^M
Orig. nr.		A-RSDCOMPACT 4/90-10	A-RSDCOMPACT4/250-10
Spanning	V	3x400	3x400
Maximum druk	bar	10	10
Effectief afgegeven lucht	m ³ /min @ max.	0,44	0,44
Vermogen motor	kW	4,0	4,0
Tankinhoud	l	90	250
Aansluiting	inch	1/2	1/2
Geluidsniveau	dB(A)	63	63
Gewicht	kg	150,00	225,00
Afmetingen (l x b x h)	mm	445 x 1000 x 895	680 x 1450 x 1005
Prijs	€	4.579,00	5.100,00



aircraft[®]

Drucklufttechnik

AIRCRAFT LUCHTDruk-VERDEELSYSTEMEN

Kosten besparend & op maat

- Kunststof en Alu leidingen Ø15 tot 28mm
- Voor kleine werkplaatsen tot fabrieksgebouwen
- Eenvoudige montage met snelkoppelingen
- Onderhoudsarm
- Kostenbesparend

VYNCKIER stelt graag met u samen een maatoplossing voor.
Contacteer onze binnendienst voor meer informatie

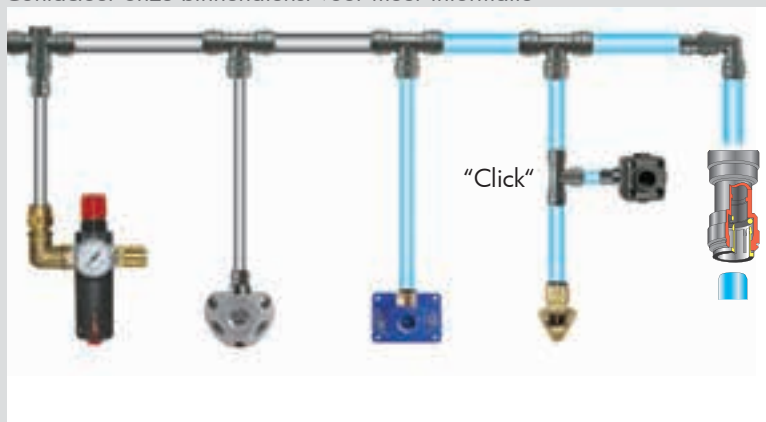



HET AIRCRAFT DRUKLUCHTSYSTEEM BIEDT DE VOLGENDE VOORDELEN :

- Gladde kunststof wand, met perfecte luchtgeleiding
- Snelle en eenvoudige installatie met snelkoppelingen, zonder gereedschap
- 50% tijdsbesparing op de montagetijd
- Geen extra dichtingen of materialen nodig
- De koppelingen zijn veelvoudig opnieuw bruikbaar
- Toepasbaar met allerhande metalen of kunststof buizen
- Flexibel aanpasbare aftakdozen
- Onderhoudsvrij systeem
- U bespaart op onderhoudskosten, installatiekosten en bedrijfskosten

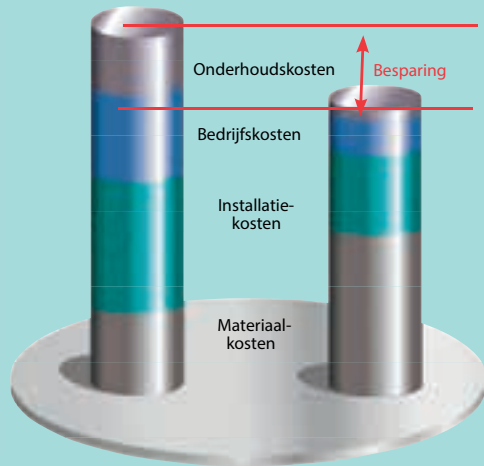

SNELKOPPELINGEN: SNELLE INSTALLATIE DOOR HET EENVOUDIG INEENSCHUIVEN :

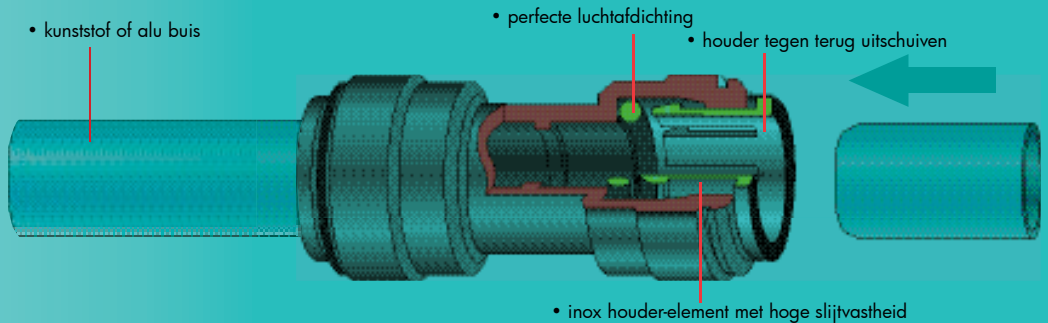

Aircontrol units



Filterdrukregelaar.

Order nr.	712316000 M	712316200 M
Aansluiting	inch 1/4	1/2
Diameter manometer	mm 40	50
Prijs	€ 45,00	54,00



Accessoire voor filterdrukregelaar.

Order nr.	Omschrijving	Prijs €
712316003 M	nanometer diam. 40mm 1/8" achter	8,50
712316001 M	vervangglas drukregelaar Ac 1/4" voor 712316000	18,00
712316201 M	vervangglas drukregelaar Ac 1/2" voor 712316200	20,50
712506450 M	nanometer diam. 50mm 1/4" achter	8,20



Olievernevelaar. Voor smering van drukluichtools

Order nr.	712316060 M	712316260 M
Aansluiting	inch 1/4	1/2
Prijs	€ 32,00	42,00



Accessoire voor olievernelaar.

Order nr.	712316061 M	712316261 M
Omschrijving	vervangglas olievernelaar 712316060	vervangglas olievernelaar 712316260
Prijs	€ 18,00	21,50



Waterafscheider.

Order nr.	712316070 M	712316270 M
Aansluiting	inch 1/4	1/2
Prijs	€ 32,00	40,00



Air control Unit. Bestaat uit filterdrukregelaar en olievernelaar.

Order nr.	712316080 M	712316280 M
Aansluiting	inch 1/4	1/2
Prijs	€ 79,00	99,00



Drukregelaar 1/4" 12 bar (oa silence 50).

Order nr.	712316050 M
Prijs	€ 21,00



Inline drukregelaar met manometer. Om de luchtdruk exact te regelen aan het verfpistool.

Order nr.	712101910 T
Prijs	€ 33,00



Mini olievernelaar 1/4". Speciaal voor Race luchtdruktoestellen. Alle luchtdruktoestellen moeten voldoende voorzien zijn van olie teneinde slijtage en roest te voorkomen.

Order nr.	205710106 M
Prijs	€ 10,50



Elektronische condensafscheider.

- volautomatisch verwijderen van condens uit de compressortank en -leidingen
- voorkom verlies van druk op uw systeem.
- ook voor moeilijk bereikbare plaatsen
- geschikt voor alle types compressoren en systemen
- Met Ledindicator, alarmgeluid, en testknop

Order nr.	712059080 M
Compressorcapaciteit	max. m ³ /min 7,5
Droog capaciteit	max. m ³ /min 14,9
Werkdruk	min/max bar 0/16,0
Temperatuur minimum/maximum	°C 1,5-65
Prijs	€ 139,00



Waterafscheider. De Bekomat automatische condensaatafleider verwijdert condensatievocht. Afleiden van het vocht zonder onnodig drukluichtverlies.

Voordelen:

- geen onnodig drukluichtverlies
- tapt enkel af wanneer nodig
- sensor herkent elke vorm van condensatievocht
- bestand tegen vuil, oliehoudende en agressieve condensaten
- onderhoudsvrij

Bekomat 31/32 werkt op 230V, eenvoudig aansluitbaar op de ketel of filter. Model 32 met alarmfunctie en instelbare foutmelder.

Order nr.	712049049 M	712049053 M
Compressorcapaciteit	max. m ³ /min 2,5	5
Droog capaciteit	max. m ³ /min 5	10
Werkdruk	min/max bar 0,8/16,0	0,8/16,0
Temperatuur minimum/ maximum	C° 1-60	1-60
Prijs	€ 199,00	249,00

Onderdelen



Orion-koppeling G 1/4" met buitendraad.

Order nr.	712200100 M
Min. bestelhoeveelheid	10
VE	1
Prijs/VE	€ 8,50



Aircraft EURO snelkoppelingen met buitendraad.

Order nr.	712201001 M	712201003 M
Aansluiting inch	1/4	1/2
Min. bestelhoeveelheid	10	10
VE	1	1
Prijs/VE	€ 4,79	4,79



Snelkoppeling met EURO aansluiting. Binnendraad

Order nr.	712201011 M	712201012 M
Aansluiting inch	1/4	3/8
Min. bestelhoeveelheid	10	10
VE	1	1
Prijs/VE	€ 4,79	4,79

Tankbatterijen



Vergroot je drukluichtcapaciteit met 150 tot 400 liter extra, door middel van een tankbatterij op maat.

Ideaal om bestaande compressoren met kleine tankcapaciteit uit te breiden. Lost het probleem van een krap compressorlokaal op, de tankbatterij kan op afstand van de compressor geplaatst worden.

Tankbatterij KB 2x100/10

2x 100L druktank 10 bar

Extra capaciteit op uw bestaande installatie

De grotere drukluichtvoorraad kan piekbehoefes opvangen.

Elke tank is voorzien van een afsluitkraan en manometer, om indien nodig een snellere drukopbouw te bekomen

Plaatsbesparend door verticale opstelling: het grootste volume op de kleinste oppervlakte

Tankbatterij KB 2x75/13

2x 75L druktank 13 bar

Extra capaciteit op uw bestaande installatie

De grotere drukluichtvoorraad kan piekbehoefes opvangen.

Elke tank is voorzien van een afsluitkraan en manometer, om indien nodig een snellere drukopbouw te bekomen

Plaatsbesparend door verticale opstelling: het grootste volume op de kleinste oppervlakte

Tankbatterij KB 4x100/10

4x 100L druktank 10 bar

Extra capaciteit op uw bestaande installatie

De grotere drukluichtvoorraad kan piekbehoefes opvangen.

Elke tank is voorzien van een afsluitkraan en manometer, om indien nodig een snellere drukopbouw te bekomen

Plaatsbesparend door verticale opstelling: het grootste volume op de kleinste oppervlakte

Order nr.	712502102 M	712502104 M	712502132 M
Maximum druk bar	10	10	13
Omschrijving l	2x100	4x100	2x75
Prijs	€ 1.230,00	2.030,00	1.440,00

holzkraft[®] Holzbearbeitungsmaschinen

HOLZKRAFT QUALITY MACHINES FOR FIREWOOD

The desires of our customers and the experience gained over decades have always been forming the basis of our modern, safe and most of all effective machines.

The Holzkraft HWS 700 was appointed best in the practical test among other machines.

Holzkraft machines for firewood are used by professionals in agriculture and forestry as well as by private users.

HOLZKRAFT machines represent quality, reliability, safety and longevity.



Machines for firewood:

Wood splitter for beginners
Wood splitter for professionals
Firewood saw
Combined table saw
Roller table circular saw



holzstar[®] Holzbearbeitungsmaschinen

HOLZSTAR WOODWORKING MACHINERY FOR THE CRAFTSMEN

Perfect for beginners in woodworking.

HOLZSTAR provides a woodworking program of beginners for various fields of application. For example model making, interior fittings, building sites, production of toys, etc.



Woodworking machinery

- Roller stands
- Scroll saws
- Band saws
- Circular saws
- Planing
- Turnery
- Grinding
- Dust collectors
- Accessories





Schuur- & schaafmachines



Universele band- en schijfschuurmachine. Voor ontbramen, afvlakken, en slijpen. Geschikt voor alle materialen en vormen. Gietijzeren constructie. Traploos zwenkbare slijpband van 0 tot 45°. Snelspanner voor een eenvoudige en snelle schuurband wissel. Geïntegreerde aansluiting voor stofzuiger. Standaard geleverd met 1 schuurband en schuurschijf.

Order nr.		715904150 ^M	715904250 ^M
Orig. nr.		BTS150	BTS250
Spanning	V	230	230
Afmetingen tafel (b x d)	mm	150x230	360X200
Toerental	tpm	2850	1440
Vermogen motor	kW	0,25	0,8
Afzuiging diameter	mm	58	58
Afmetingen schuurband	mm	915x100	1220X150
Diameter schuurschijf	mm	150	250
Gewicht	kg	18,00	50,00
Afmetingen (l x b x h)	mm	560 x 270 x 300	720 x 410 x 440
Prijs	€	179,00	459,00



Machinevoet voor BTS 250

Order nr.		715914250 ^M
Prijs	€	64,00

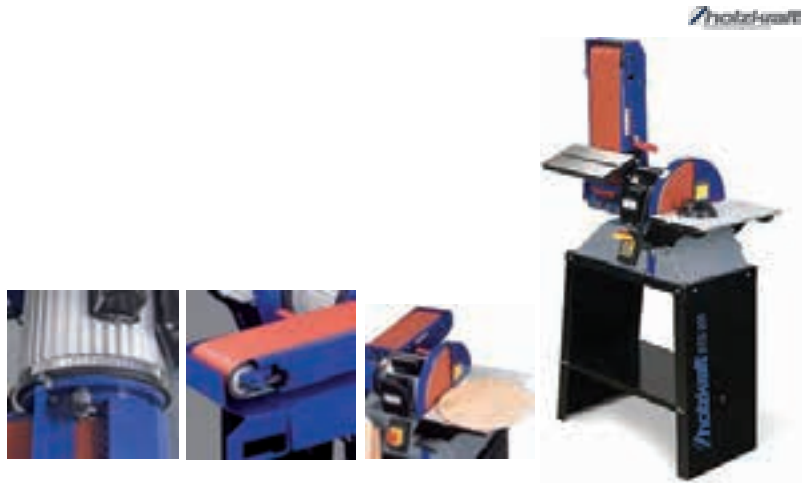

Universele bandschuurmachine met zijdelingse schuurschijf. Voor afbramen, vlakmaken, en slijpen. Geschikt voor alle materialen en vormen. Metalen constructie. Traploos zwenkbare slijpband van -15° tot 45°. Snelspanner voor een eenvoudige en snelle schuurbandwisseling. Geïntegreerde aansluiting voor stofzuiger. Standaard geleverd met 1 schuurband, 1 schuurschijf en voet.

Order nr.		715902200 M
Orig. nr.		BTS200
Spanning	V	230
Vermogen motor	kW	1,1
Afmetingen schuurband	mm	152x1219
Diameter schuurschijf	mm	305
Snelheid	m/s	12
Gietijzeren werktafel	mm	315x155
Aluminium werktafel	mm	400x225
Hoek werktafel	°	-15 - +45
Afzuiging	mm	2 x 63
Hoek band	°	0-90
Gewicht	kg	53,00
Afmetingen (l x b x h)	mm	830 x 620 x 1340
Prijs	€	575,00

Schuurschijven en -banden voor Holzstar schuurmachines BTS 150, 200 en 250.



Order nr.	Omschrijving	Korrel K	Voor type	VE	Min. bestelhoeveelheid	Prijs/VE €
715911006 M	Band	60	BTS150	1	10	5,50
715911008 M	Band	80	BTS150	1	10	5,40
715911010 M	Band	100	BTS150	1	10	5,40
715911012 M	Band	120	BTS150	1	10	5,30
715911015 M	Band	150	BTS150	1	10	5,30
715911506 M	Klitschijf 150mm	60	BTS150	1	10	1,50
715911508 M	Klitschijf 150mm	80	BTS150	1	10	1,40
715911510 M	Klitschijf 150mm	100	BTS150	1	10	1,40
715911512 M	Klitschijf 150mm	120	BTS150	1	10	1,40
715911515 M	Klitschijf 150mm	150	BTS150	1	10	1,40
715911206 M	Band	60	BTS250	1	10	8,00
715911208 M	Band	80	BTS250	1	10	7,80
715911210 M	Band	100	BTS250	1	10	6,80
715911212 M	Band	120	BTS250	1	10	6,70
715911218 M	Band	180	BTS250	1	10	6,70
715912506 M	Klitschijf 250mm	60	BTS250	1	10	3,10
715912508 M	Klitschijf 250mm	80	BTS250	1	10	3,10
715912510 M	Klitschijf 250mm	100	BTS250	1	10	3,00
715912512 M	Klitschijf 250mm	120	BTS250	1	10	3,00
715912515 M	Klitschijf 250mm	150	BTS250	1	10	2,90
715911001 M	Velcroschijf 150mm		BTS150	1	1	8,00
715912501 M	Velcroschijf 250mm		BTS250	1	1	12,00
715900301 M	Scheidingsplaat voor schuurschijven		Universeel	1	1	24,50

profistar



Bandschuurmachine met lang werkvlak en stabiele tafels.

- Tafel traploos in lengte en hoek instelbaar van van 0° tot 45°.
- Horizontaal en verticaal bruikbaar voor meer verticale toepassingsmogelijkheden
- Snel wisselen van slijpbanden
- Verstelbare verstekstop inbegrepen
- Grafiet afdekking onder de schuurband voor een betere geleiding en een langere levensduur

MACHINES

Order nr.		715900790 M
Orig. nr.		KSO790
Spanning	V	400
Vermogen motor	kW	1,5
Afmetingen schuurband	mm	2010x152
Tafelhoogte	mm	810
Afmetingen lange tafel	mm	790x221
Afmetingen tafel zijkant	mm	514x221
Schuurbandsnelheid	m/s	13
Maximum lengte schuurband	mm	790
Diameter rondschuren	mm	70
Diameter zuigmond	mm	100
Gewicht	kg	86,00
Afmetingen (l x b x h)	mm	1270 x 540 x 1020
Prijs	€	649,00



Bandschuurmachine voor werkstukken met lange afmetingen.

- Met oscillerende slijpband voor hoge en nette schuurresultaten
- Standaard inclusief hoekaanslag van -45° tot $+45^\circ$.
- Hoekverstelling van de band (0° tot 90°) voor verticale en horizontale toepassingen
- Werktafel met hoogteverstelling via handwiel
- Robuuste werktafel van gietijzer met T-gleuven
- Inclusief in hoogte verstelbare extra zijtafel
- Snel en gemakkelijk vervangen van de band
- Geveerde kleminrichting garandeert een uniforme bandspanning
- Met grafiet afdekking voor een hogere levensduur van de slijpband
- Zuigmond diameter 100mm
- Met voet geleverd

Order nr.		715900850 M
Orig. nr.		KSO850
Spanning	V	400
Vermogen motor	kW	2,2
Afmetingen schuurband	mm	2515x152
Schuurbandsnelheid	m/s	16
Diameter zuigmond	mm	100
Tafelhoogte verstelbaar	mm	80
Werkstuk aanslag	mm	700x60
afmetingen tafel	mm	840x300
Gewicht	kg	148,00
Afmetingen (l x b x h)	mm	1430 x 600 x 1250
Prijs	€	1.089,00

Schuurbanden Holzstar KSO 790 en KSO 850 bandschuurmachines.



Order nr.	Korrel K	Type	Afmetingen (l x b) mm	Min. bestelhoeveelheid	VE	Prijs/VE €
715917510 M	100	KSO 790	2010 x 152	10	1	10,00
715917512 M	120	KSO 790	2010 x 152	10	1	10,00
715917515 M	150	KSO 790	2010 x 152	10	1	10,00
715917518 M	180	KSO 790	2010 x 152	10	1	10,00
715917522 M	220	KSO 790	2010 x 152	10	1	10,00
715917560 M	60	KSO 790	2010 x 152	10	1	11,00
715917580 M	80	KSO 790	2010 x 152	10	1	11,00
715918510 M	100	KSO 850	2515 x 152	10	1	11,00
715918512 M	120	KSO 850	2515 x 152	10	1	11,00
715918515 M	150	KSO 850	2515 x 152	10	1	11,00
715918518 M	180	KSO 850	2515 x 152	10	1	11,00
715918522 M	220	KSO 850	2515 x 152	10	1	11,00
715918560 M	60	KSO 850	2515 x 152	10	1	11,00
715918580 M	80	KSO 850	2515 x 152	10	1	11,00



NEW



Vlakschuurmachine voor houten panelen en balken.

- De ideale schuurmachine voor de veeleisende doe-het-zelver met beperkte ruimte.
- Voor het op maat brengen en opschuren van massief hout en panelen.
- Uitstekende schuurprestaties ook bij brede en ook bij lange werkstukken.
- Met afzuigmond voor externe stofafzuiging.
- Eenvoudige hoogte-instelling met handwiel en schaal aanduiding.
- Handvat en wielen voor eenvoudig transport.
- Eenvoudige en snelle bandwissel.

MACHINES

Order nr.		715901405 M
Orig. nr.		ZSM405
Spanning	V	230
Vermogen motor	kW	1,5
Schuurbandsnelheid	m/s	0,5-3
Diameter afzuiging	mm	100
Slijpbreedte	mm	410
Slijpbandsnelheid	rpm	1440
Debiet	m ³ /u	1275
Gewicht	kg	38,00
Afmetingen (l x b x h)	mm	1030 x 950 x 1300
Prijs	€	749,00



Breedbandschuurmachine voor hout.

- Gelaste staalconstructie met stabiele gietijzeren componenten
- Op maat brengen en opschuren van massief hout en panelen
- Eenvoudige en fijn regelbare bediening van dikte en traploze snelheid
- Afgedichte kogellagers tegen stof en spaanders
- Overzichtelijke aflezing van de ingestelde dikte
- Snelle slijpbandwissel met veer
- Industriële doorvoerband met grote stabiliteit en grip

Order nr.		715382330 ^M	715382430 ^M
Orig. nr.		WSM330	WSM430
Spanning	V	230	230
Vermogen motor	kW	0,7	1,1
Diameter afzuiging	mm	100	100
Diameter wals	mm	75	75
Slijpbreedte	mm	330	430
Snelheid	m/min	0-6 traploos	0-7 traploos
Snelheid band	m/sec	1720	1720
Debiet	m ³ /u	1275	1275
Gewicht	kg	89,00	98,00
Afmetingen (l x b x h)	mm	622 x 648 x 762	622 x 749 x 762
Prijs	€	1.699,00	1.999,00



NEW



Gecombineerde vlak- en vandiktebank. Tafelmodel (ADH250) of voetmodel (ADH260). Ideale kleine machine voor de thuiswerker en hobbyist. Eenvoudige en precieze instelling van de schaafdikte (tot max. 2 mm). Automatische doorvoer van materiaal. Eenvoudig instelbare aluminium aanslag, draaibaar van 90° tot 45°. Geprofileerde boventafel, vervaardigd uit gietaluminium. Ingebouwd opbergvak en verplaatsbare afzuigmond.

Order nr.		715905250 ^M	715903260 ^M
Orig. nr.		ADH250	ADH260
Spanning	V	230	230
Werkhoogte minimum/maximum	mm	6/160	4/160
Maximum schaafcapaciteit/doorgang	mm	2	3
Diameter schaafwielen	mm	50	63
Toerental	tpm	8500	6500
Vermogen motor	kW	1,5	2
Afmetingen vlaktafel (l x b)	mm	1050x260	1030x280
Afmetingen vandiketafel (l x b)	mm	254x450	260x400
Schaafbreedte	mm	254	260
Aantal messen		2	2
Diameter afzuiging	mm	80	100
Gewicht	kg	40,00	73,00
Prijs	€	569,00	999,00



Vervangmessen (per 2 st.) voor dikteschaaf machine DH250

Order nr.		715913250 ^M
Prijs	€	42,00



Set vervangmessen (2st.) voor vandikteschaaf ADH250.

Order nr.		715915250 ^M
Prijs	€	18,00



Set vervangmessen (2 st.) voor vandikteschaaf ADH260.

Order nr.		715913260 ^M
Prijs	€	48,00



Gecombineerde vlak- en vandikteschaafmachine. 310 mm schaaftbreedte met onderbouw. Ideaal voor de ambitieuze thuiswerker of professional. Geschikt voor het schaven en afwerken van alle houtsoorten. Eenvoudige en precieze instelling van de schaaftdikte (tot max. 3 mm). Automatische aanvoer (5 m/min.). Eenvoudig instelbare aluminium aanslag, draaibaar van 0° tot 45°. Geprofileerde boventafel, vervaardigd uit aluminium met handwiel en instelbare teller. Tafel van de dikteschaaf uit gietijzer met geslepen bovenvlak. Krachtige 230 Volt Motor. Ingebouwde, verplaatsbare afzuigmond die zowel voor de langsschaaf als voor de dikteschaaf kan gebruikt worden. Met noodschakelaar.

Order nr.		715903300 ^M
Orig. nr.		ADH310
Spanning	V	3x400
Afmetingen tafel (b x d)	mm	605x330
Afmetingen schaaftafel (l x b)	mm	520x312
Schaaftbreedte		310
Werkhoogte minimum/maximum	mm	250
Maximum schaaftcapaciteit/doorgang	mm	3
Snelheid automatische aanvoer	m/min	3
Diameter schaaftwielen	mm	70
Aantal messen	mm	3
Toerental	tpm	5300
Vermogen motor	kW	2,2
Afzuiging diameter	mm	100
Gewicht	kg	73,00
Afmetingen (l x b x h)	mm	1300 x 1000 x 1300
Prijs	€	1.829,00

Vervangmessen (3 stuks) voor dikteschaaf machine ADH310



Order nr.		715913311 ^M
Orig. nr.		5913311
Prijs	€	94,00

Slijpmachines

holzstar



Standaard met opbergvak voor accessoires

ACCESSOIRES
p. 1066



Hoekverstelling

Messenslijpmachine voor nat en droog slijpen. In de hoogte verstelbare houderbeugel dia. 12mm. Waterbestendige slijpsteen met waterbakje. Dankzij het geringe toerental van 90 rpm/min in combinatie met het water kan geslepen worden zonder hitte. Aan/uit schakelaar met noodstop. Standaard geleverd met wetschijf, universele houder, hoekmeter en opbergvak. Draagbaar. Optionele messenhouders laten toe om gemakkelijk alle soorten messen te slijpen.

Order nr.		715902251
Orig. nr.		NTS251
Spanning	V	230
Vermogen motor	W	200
Afmetingen slijpsteen (diameter x b)	mm	250x50
Afmetingen lederen schijf (diameter x b)	mm	220x30
Toerental	tpm	90
Gewicht	kg	20,00
Afmetingen (l x b x h)	mm	340 x 280 x 460
Prijs	€	225,00



Slijpen van messen
Order nr. 713800027



Slijpen van rondmessen
Order nr. 713800032



Slijpen van bijlen
Order nr. 713800018



Uitlijnen van slijpsteen
Order nr. 713800029



Slijpen van rondbeitels
Order nr. 713800021



Slijpen van freesmessen
Order nr. 713800024



Hulpstuk voor accessoires
Order nr. 713800026



Slijpen onder hoek van 0-30°
Order nr. 713800038



Vorbereiden slijpsteen (grof/fijn)
Order nr. 713800030

Accessoires voor NTS251

Order nr.	Omschrijving	Prijs €
713800027	voor messen	46,00
713800029	voor uitlijnen van slijpsteen	61,00
713800024	voor freesmessen	58,00
713800026	hulpstuk voor accessoires	38,00
713800030	slijpsteen voor voorbereiden	26,00
713800018	voor van bijlen	30,00
713800038	voor slijpen onder hoek 0-30°	27,90
713800021	ronde houtbeitels	51,00
713800032	voor rondmessen	18,50



Langgatboormachines



NEW



dubbele geleiding



deuvelinrichting



optionele hoekaanslag 715336718

Compacte langgatboormachine. Plaatsbesparend model voor de veeleisende houtbewerker.

- Boorkop met dubbele geleiding
- Hoogteverstelling boorkop met schaalaflezing
- Eenhandsbediening voor snel en precies boren
- Geleverd met deuvelinrichting voor gemakkelijk positioneren van de deuvelgaten
- Stabiele constructie uit staal en gietijzer
- Optionele hoekaanslag met gradenverdeling
- Optionele verplaatsbare voet UF230

Order nr.		715326617 M
Orig. nr.		LLB16H
Spanning	V	3x400
Vermogen motor	kW	1,1
Afmetingen tafel	mm	500x200
Boorbreedte	mm	200
Boordiepte	mm	150
Hoogteverstelling boorkop	mm	150
Toerental	tpm	3000
Gewicht	kg	120,00
Afmetingen (l x b x h)	mm	560 x 740 x 1320
Prijs	€	1.859,00



Set langgatboren 5-delig rechts voor LLB16H.

- ø 8/10/12/14 mm met 12,8 mm Schacht
- ø 16 mm met 15,8 mm Schacht
- Rechtsdraaiend
- Duits fabrikaat

Order nr.		715333682 M
Prijs	€	104,00

Zaagmachines



Verticale bandzaagmachine voor hout en kunststof voor modelbouw en hobby. Plaatstalen constructie. Aluminium lengteaanslag met excentrische snelspanning en schaalverdeling. Zaagtafel uit gietijzer met geslepen oppervlak kantelbaar van 0-45° met schaalverdeling. 3-rollen bandzaaggeleiding zowel boven- als onderaan. Aandrijfwielen uit giet-aluminium met een coating voor een hogere levensduur van de zaagbladen. Geleverd zonder voet, met zaagblad.

Order nr.		715900251	715900351
Orig. nr.		HBS251	HBS351-2
Spanning	V	230	230
Lengte zaagblad	mm	1790	2490
Diameter afzuiging	mm	58	100
Maximum zaagbreedte met aanslag	mm	245	345
Maximum zaaghoogte	mm	120	200
Zaagsnelheid	m/min	696	438-900
Grootte werktafel (l x b)	mm	290x290	548x400
Vermogen motor	W	350	1000
Gewicht	kg	32,00	70,00
Afmetingen (l x b x h)	mm	420 x 330 x 880	520 x 380 x 1155
Prijs	€	299,00	615,00

Zaagblad voor lintzaagmachines Holzstar en Holzkraft HBS-DKS.

Order nr.	Voor type	Vertanding	Voor	Afmetingen (l x b x h)	Prijs
		T		mm	€
715162512	HBS251	6	hout/kunststof	1790 x 12 x 0.36	27,50
715163203	HBS251	14	kunststof/metaal	1790 x 4 x 0.65	25,50
715163206	HBS251	14	kunststof/metaal	1790 x 6 x 0.65	21,50
715162506	HBS251	6	hout/kunststof	1790 x 6 x 0.36	18,90
715163515	HBS351	6	hout/kunststof	2562 x 15 x 0.5	26,00
715163512	HBS351	5	hout/kunststof	2562 x 12 x 0.5	22,00
715163506	HBS351	4	hout/kunststof	2562 x 6 x 0.5	28,50
715163606	HBS 351-2/HBS351S	4	hout/kunststof	2490 x 6 x 0.65	29,90

voor up-to-date informatie zie online catalogus op www.vynckier.biz

Houtbewerkingsmachines

Holzkratt



Verticale precisie bandzaagmachine voor hout voor de veeleisende ambachtsman. De stabiele machinebehuizing en de solide stalen voet geven de machine een geruisloze werking. Grote zaagtafel uit gietijzer met geslepen en gepolierd oppervlak kantelbaar van 0-45° met schaalverdeling. Comfortabel zagen dankzij de laserverlichting op de zaagsnede. Zaagbandspanning dmv een excentrische hendel aan de achterzijde. Standaard met 2 snelheden. Precisie 3-rollen bandzaaggeleiding zowel boven als onderaan. Snelle hoogteverstelling van de tafel dmv een draaiknop en tandlat met een schaalverdeling. Soepele alu-parallelaanslag met excentrische klemming en loep. Aandrijfwielen uit giet-aluminium met een speciaal coating voor een hogere levensduur van de zaagbladen. Geleverd met zaagblad en hoekaanslag tot 60°.

Order nr.		715153501	715154301	715154303	715155303
Orig. nr.		HBS351	HBS431	HBS433	HBS533
Spanning	V	230	230	3x400	3x400
Lengte zaagblad	mm	2562	3345	3345	3865
Maximum zaagbreedte met aanslag	mm	321	370	370	474
Maximum zaagbreedte zonder aanslag	mm	346	410	410	514
Maximum zaaghoogte	mm	200	270	270	270
Diameter vlieg wiel	mm	356	430	430	530
Zaagsnelheid	m/min	650-400	900-450	900-450	850-430
Zaagbladgeleiding		boven-onder	boven-onder	boven-onder	boven-onder
Diameter afzuigmond	mm	100	2x100	2x100	2x100
Hellingshoek werktafel	°	-10+45	-10+45	-10+45	-10+45
Grootte werktafel (l x b)	mm	495x356	610x431	610x431	680x530
Vermogen motor	W	550	1500	1500	2250
Gewicht	kg	80,00	130,00	130,00	163,00
Afmetingen (l x b x h)	mm	610 x 445 x 1753	768 x 512 x 2048	768 x 512 x 2048	1024 x 793 x 2048
Prijs	€	855,00	1.629,00	1.629,00	1.959,00



Accessoires voor bandzaagmachine HBS

Order nr.	Omschrijving	HBS	Prijs
		Tpi	€
715910810	hoekaanslag	HBS251	27,00
715910812	machinevoet	HBS351-2	59,00
715910814	hoekaanslag	3122 + 351-2	24,00
715910813	machinevoet	HBS251	46,00



Industriële verticale bandzaagmachine. Machine met een hoog eigengewichten. Constructie uit één stuk garanderen een stille en rustige werking. Grote zaagtafel uit gietijzer met geslepen en gepolierd oppervlak kantelbaar van 0-20° met schaalverdeling. Gepatenteerde hoogteverstelling van de tafel dmv een draaiknop en tandlat met een schaalverdeling. Zaagbandspanning dmv een excentrische hendel aan de achterzijde. Keramische bandzaaggeleiding zowel boven als onderaan. Grote gietijzeren aanslag. Aandrijfwielen uit gietijzer met een speciaal coating voor een hogere levensduur van de zaagbladen. Geleverd met zaagblad en hoekaanslag tot 60°.

Order nr.		715155313	715156303
Orig. nr.		HBS533S	HBS633S
Spanning	V	3x400	3x400
Lengte zaagblad	mm	4190	4600
Maximum zaagbreedte met aanslag	mm	465	570
Maximum zaagbreedte zonder aanslag	mm	510	610
Maximum zaaghoogte	mm	350	400
Diameter vliegwielen	mm	530	630
Zaagsnelheid	m/min	1400	1615
Zaagbladgeleiding		boven-onder	boven-onder
Diameter afzuigmond	mm	2x100	2x100
Hellingshoek werktafel	°	0+20	0+20
Grootte werktafel (l x b)	mm	750x530	830x600
Vermogen motor	W	3750	3500
Gewicht	kg	305,00	380,00
Afmetingen (l x b x h)	mm	1000 x 720 x 2040	1190 x 750 x 2060
Prijs	€	2.719,00	3.480,00

Zaagblad voor lintzaagmachines Horzstar en Holzkraft HBS-DKS.

Order nr.	Voor type	Vertanding T	Voor	Afmetingen (l x b x h) mm	Prijs €
715163712	HBS 351-2	5	hout/kunststof	2490 x 6 x 0,5	32,50
715163226	HBS 351-2	14	hout/kunststof/metaal	2490 x 6 x 0,65	33,00
715163715	HBS 351-2	5	hout/kunststof	2490 x 15 x 0,5	25,50
715163706	HBS 351-2	4	hout/kunststof	2490 x 6 x 0,5	32,00
715163606	HBS 351-2/HBS351S	4	hout/kunststof	2490 x 6 x 0,65	29,90
715164310	HBS431/433	5	hout	3345 x 10 x 0,5	35,50
715164315	HBS431/433	5	hout	3345 x 15 x 0,5	35,50
715164320	HBS431/433	6	hout	3345 x 20 x 0,5	44,00
715164325	HBS431/433	6	kunststof/metaal	3345 x 25 x 0,5	43,50
715165310	HBS533	5	hout	3865 x 10 x 0,5	42,50
715165315	HBS533	5	hout	3865 x 15 x 0,5	46,00
715165320	HBS533	6	hout	3865 x 20 x 0,5	44,50
715165325	HBS533	6	hout	3865 x 25 x 0,5	47,50
715165327	HBS533	A3	kunststof/metaal	3865 x 15 x 0,5	46,50
715165311	HBS533S	5	hout	4190 x 10 x 0,5	46,00
715165316	HBS533S	5	hout	4190 x 15 x 0,5	46,00
715165321	HBS533S	6	hout	4190 x 20 x 0,5	47,00
715165326	HBS533S	6	hout	4190 x 25 x 0,5	53,50
715166310	HBS633S	6	hout	4600 x 10 x 0,5	37,50
715166315	HBS633S	6	hout	4600 x 15 x 0,6	43,50
715166320	HBS633S	8	hout	4600 x 20 x 0,6	52,50
715166325	HBS633S	8	hout	4600 x 25 x 0,5	56,50
715166326	HBS633S	A3	kunststof/metaal	4600 x 25 x 0,6	61,30



DKS501 VARIO



DKS502 VARIO

Figuurzaag met variabel toerental voor modelbouwers, maquettebouw, productontwikkeling of opleidingsdoeleinden. Geschikt voor de verwerking van zacht hout, kunststof, piepschuim, ...
 Grote uitlading voor diepe werkstukken.
 Werktafel zwenkbaar tot van -45° tot 0° (DKS502) en van -15° tot +45° (DKS501).
 Variabel toerental voor het optimaal verzagen van diverse materialen.
 Gietijzeren onderstel en zaagarm voor een rustige loop.
 Ingebouwde blaastuit blaast stof direct weg van de zaaglijn.
 Transparante afdekkap in hoogte verstelbaar.

MACHINES

Order nr.		715900500 ^M	715900504 ^M
Orig. nr.		DKS501 VARIO	DKS502 VARIO
Spanning	V	230	230
Maximum snijdiepte	mm	50	50
Uitlading	mm	406	406
Lengte zaagblad	mm	133	133
Aantal omwentelingen	rpm	400-1600	700-1400
Tafelafmetingen	mm	380x250	310x480
Vermogen	W	125	120
Diameter afzuiging	mm	38	38
Gewicht	kg	13,00	12,70
Afmetingen (l x b x h)	mm	600 x 300 x 310	310 x 740 x 440
Prijs	€	174,00	125,00



DKS5530 VARIO

Figuurzaagmachine voor het grotere knutsel - en modelbouwwerk met traploos regelbare snelheid van het zaagblad. Traploos instelbare snelheid van het zaagblad (van 400 tot 1600 omwentelingen/min.). Ideaal voor het bewerken van hout, kunststof, plexiglas, gips of dunne metalen. Roteerbare werktafel van -45° tot + 45°; gietijzeren constructie en tafel. Met opslagruimte voor zaagbladen. Zware en stabiele machine.

Een ingebouwde blazer verwijdert spaanders van de werktafel bij het zagen. Een doorzichtige plexiglas beschermkap over het zaagblad zorgt voor een optimale bescherming van de ogen. Universele zaagbladopname. Ingebouwde afzuigbek. Geleverd met zaagblad.

Order nr.	715900505 M	
Orig. nr.	DKS530 VARIO	
Spanning	V	230
Maximum snijdiepte	mm	53
Uitlading	mm	406
Lengte zaagblad	mm	127
Aantal omwentelingen	rpm	500-1550
Tafelafmetingen	mm	310x480
Vermogen motor	W	225
Gewicht	kg	20,50
Afmetingen (l x b x h)	mm	740 x 310 x 440
Prijs	€	329,00

Zaagblad voor lintzaagmachines Horzstar en Holzkraft HBS-DKS. VE = verpakkingseenheid.

Order nr.	Voor type	Vertanding	Voor	Afmetingen (l x b x h) mm	VE	Min. bestelhoeveelheid	Prijs/VE €
715911628 M	DKS	10	hout/kunststof/gips	133 x 3 x 0.25	6	1	11,90
715911660 M	DKS	6	hout/kunststof	133 x 6 x 0.4	6	1	11,90
715911661 M	DKS	12	metaal	133 x 6 x 0.4	6	1	11,90



NEW

Afkort en verstekzaag met trekfunctie.
 Trekfunctie met dubbele stabiele geleiding voor het exact verzagen van brede werkstukken
 Krachtige 2kW motor
 Zaagcapaciteit tot 100x340mm
 Vastek en neiging traploos instelbaar
 Laserlijn verlicht de zaaglijn en maakt snel en precies zagen superegemakkelijk
 Robuuste gietaluminium onderplaat
 Compact en draagbaar
 Zijaanslag met uitschuifbare zijwaartse verlengingen (werkstuksteun) voor lange werkstukken
 2-voudig Instelbare diepteaanslag voor het zagen van groeven
 Werkstukkleem
 Met spanklem voor vastklemmen op werktafel
 Afzuigmond voor meegeleverde stofzak of aansluiting van externe stofafzuiging
 Met zaagblad diam.305 x 3,2 x diam.30mm Z48

Order nr.		715702305 M
Orig. nr.		KGZ305E
Neiging 0°/Vastek 0°	mm	100x340
Neiging 45°/Vastek 0° links	mm	40x340
Neiging 45°/Vastek 0° rechts	mm	40x340
Neiging 0°/Vastek 45° links	mm	100x240
Neiging 45°/Vastek 45° rechts	mm	40x240
Diameter zaagblad	mm	305
Vermogen motor	kW	2,0
Gewicht	kg	22,00
Afmetingen (l x b x h)	mm	835 x 570 x 790
Prijs	€	289,00

Cirkelzaagbladen voor KGZ305/KEZ3050.

Order nr.		715260305 M	715260306 M
Vertanding	T	60	72
Afmetingen (l x b x h)	mm	300 x 3.2 x 30	300 x 3.2 x 30
Prijs	€	145,00	143,00



Professionele afkort- en verstekzaag met trekfunctie.

Trekfunctie met dubbele stabiele geleiding voor het exact verzagen van brede werkstukken

Krachtige 1,8kW motor

Zaagcapaciteit tot 100x310mm

Verstek links 45°/rechts 60° en neiging 45° links/rechts

Verstek vast instelbaar op 0°/15°/22,5°/31,6°/45°/60° (60°rechts enkel)

Verstek vast instelbaar op 31,6° voor het zagen van sierlijsten en moulures

Verstekinstelling met fijnregeling aanpasbaar

Laserlijn verlicht de zaaglijn en maakt snel en precies zagen kinderspel

Robuuste gietaluminium onderplaat

Compact en draagbaar

Grote Zijaanslag met links en rechts uitschuifbare zijwaartse verlengingen (werkstuksteun) voor lange werkstukken

Instelbare diepteaanslag voor het zagen van groeven

Werkstukkleem

Met spanklem voor vastklemmen op werktafel

Afzuigmond voor meegeleverde stofzak of aansluiting van externe stofafzuiging

Optioneel leverbaar: Samenklapbare universele werktafel/rollenbaan (ref. 715900020)

Zonder zaagblad

Order nr.	715701305 ^M	
Orig. nr.		KEZ3050
Neiging 0°/Verstek 0°	mm	102x310
Neiging 45°/Verstek 0° links	mm	60x310
Neiging 45°/Verstek 0° rechts	mm	45x310
Neiging 0°/Verstek 45° links	mm	102x222
Neiging 0°/Verstek 60° rechts	mm	102x158
Neiging 45°/Verstek 45° rechts	mm	60x222
Neiging 45°/Verstek 60° rechts	mm	45x158
Diameter zaagblad	mm	305
Vermogen motor	kW	1,8
Spanning	V	230
Toerental	tpm	4200
Gewicht	kg	34,00
Afmetingen (l x b x h)	mm	1270 x 1160 x 760
Prijs	€	769,00

Houtbewerkingsmachines

holzstar



NEW



schaven frezen schaven zagen

5-voudige combinatiemachine voor zagen, vlakschaven, vandikte schaven, frezen en boren. compacte en mobiele machine, ideaal instapmodel voor de houtbewerker met beperkte werkruimte. 5 standaard houtwerkingen in 1 eenvoudige machine.

Zaagmachine met zaagblad 200x30x2,6mm Z20, schaafas met 2 schaafmessen en breedte 154mm, freesas, langgatboormachine met spanner, multifunctionele zijaanslag voor langzagen, loopwagen voor zagen en frezen en hoekaanslag.

Order nr.		715905600 ⓘ
Orig. nr.		UMK6
Spanning	V	230
Vermogen motor	kW	1
Afzuigmond	mm	58
Afzuigmond zaagblad	mm	21
Cirkelzagen		
Koers loopwagen	mm	460
Zaagblad	mm	200
Maximum zaaghoogte	mm	65
Schaven		
Werkbreedte	mm	154
Schaafmessen		2
Vandikte		
Maximum spaanafname	mm	1
Doorvoerbreedte	mm	154
Maximum doorvoerhoogte	mm	9-92
Maximum spaanafname	mm	1
Frezen		
Hoogteverstelling	mm	0-42
Spilopname	mm	12
Langgatboren		
Opname	mm	6/8/10
Opname	mm	6/8/10
Maximum hoogte	mm	95
Maximum breedte	mm	60
Gewicht	kg	52,00
Prijs	€	949,00

MACHINES

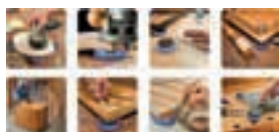

Set werkstukstoppers - 4 delig. Praktische anti-sliphulp bij het zagen, schaven, lakken, etc. Set van 4 stuks.

Order nr.		715100004 ⓘ
Prijs	€	16,00



standaard tafellenging



lensvergroting



precieze hoogteverstelling



neiging tot 45°



telescopische aanslag



zaaghoek tot 45° met aanslag

- Universele tafelzaag met precieze, rolgelagerde rolwagen met armsteun.
- Zware gietijzeren tafel voor vibratiearm werken + extra tafellenging
- Telescopische aanslag met lensvergroting voor precieze aflezing tot 2280mm.
- Hoekaanslag van -45 tot +45° instelbaar.
- Zaagblad van 0 tot 45° neigbaar via draaiknop op tandlat.
- Zaagblad in hoogte instelbaar met handwiel.
- Aluminium parallelaanslag met excenterspanner.
- Krachtige motor 2,5kW voor zowel plaatmateriaal als hardhout geschikt.
- Met Hardmetaal HM zaagblad \varnothing 250mm Z36 met noodstop.
- Afzuigmond 38mm.

Order nr.		715900255 M
Orig. nr.		TKS250 SC
Spanning	V	400
Diameter zaagblad	mm	254
Maximum hoogte	mm	42/80
Maximum verstek zaagblad	°	45-90
Afmetingen werktafel (l x b)	mm	800x348
Werkhoogte	mm	895
Toerental	tpm	4000
Vermogen motor	kW	2,5
Type motor		Elektro
Diameter stofafzuiging	mm	2x100
Gewicht	kg	190,00
Afmetingen (l x b x h)	mm	950 x 760 x 1030
Prijs	€	1.879,00

Hoekaanslag TKS250SC.



Order nr.		715910259 M
Prijs	€	27,00

Verplaatsbare sokkel TKS250SC.



Order nr.		715910258 M
Prijs	€	73,00

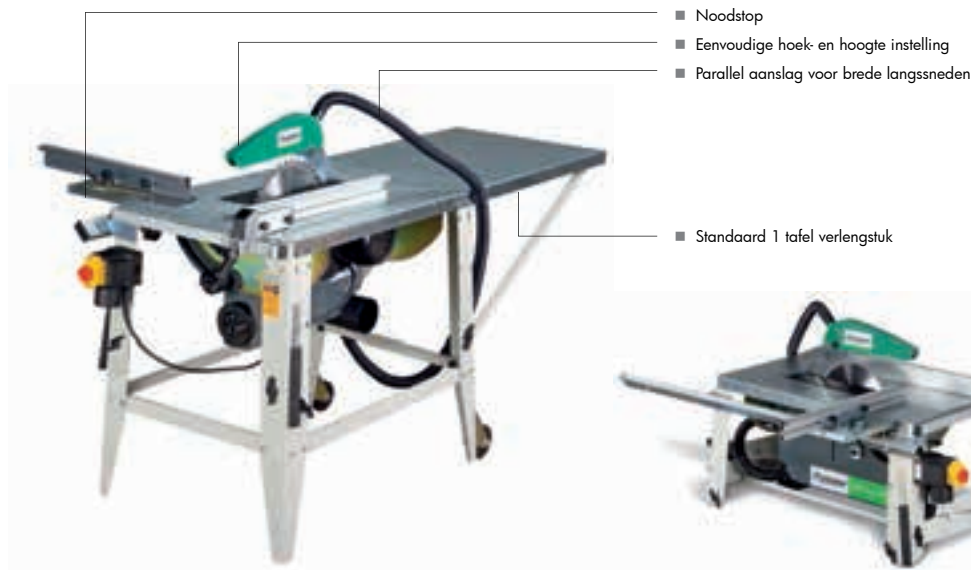

Universele tafelzaag. Diverse toepassingen bij binnenhuisinrichting, modelbouw of op de werf. Nauwkeurige hoogte en verstek instelling van het zaagblad. De krachtige motor kan zonder problemen alle soorten hout aan. Eenvoudig verrijdbaar door standaard gemonteerde wielen en handgrepen. Met zij aanslag en 1 tafelverbreiding, gelagerde verstekaanslag en zaagblad (36T). Wielen op de twee voorste steunvoeten. Beschikbaar in 230V en 3x400V.

Order nr.		715903251 ^M	715903253 ^M
Orig. nr.		TKS315 PRO-230V	TKS315 PRO-400V
Spanning	V	230	3x400
Diameter zaagblad	mm	315	315
Maximum verstek zaagblad	°	0-45	0-45
Afmetingen werktafel (l x b)	mm	800x550	800x550
Werkhoogte	mm	810	810
Toerental	tpm	2800	2800
Vermogen motor	kW	2,2	2,8
Type motor		Elektro	Elektro
Maximum hoogte		90/50	90/50
Diameter afzuiging (boven)	mm	38	38
Diameter afzuiging (onder)	mm	100	100
Gewicht	kg	50,00	50,00
Afmetingen (l x b x h)	mm	2000 x 1360 x 1000	2000 x 1360 x 1000
Prijs	€	529,00	529,00

Extra tafelstuk voor TKS 315 PRO.



Order nr.		715913251 ^M
Prijs	€	52,00



hoekaanslag -45°/+45°

precieze parallelaanslag

Mobiele tafelzaag voor algemeen gebruik. Met rolwagen. Groot en stabiel verzinkt stalen frame. Neiging zaagblad 0°- 45° instelbaar zonder gereedschap. Hoogte zaagblad instelbaar met handwiel en schaal aanduiding. Aluminium aanvoertafel met aanslag en excenterspanner. Ingebouwde wielen en handgrepen. Geleverd met zaagblad HM Ø 315 mm/Z24.

Order nr.		715903315	715903316
Orig. nr.		TKS315E230	TKS315E400
Spanning	V	230	3x400
Diameter zaagblad	mm	315	315
Maximum verstek zaagblad	°	0-45	0-45
Afmetingen werktafel (l x b)	mm	800x550	800x550
Werkhoogte	mm	800	800
Toerental	rpm	2800	2800
Vermogen motor	kW	2,0	2,8
Type motor		elektro	elektro
Diameter afzuiging (boven)	mm	38	38
Maximum snijdiepte	mm	83/60	83/60
Gewicht	kg	52,00	52,00
Prijs	€	319,00	319,00



Zaagbladen voor cirkelzaagmachines van Holzkraft en Holzstar.

Order nr.	Voor type	Asgat mm	Vertanding T	Diameter	Type	Prijs €
715262518	TKS250 SC	30	18	250	all-round	47,50
715262524	TKS250 SC	30	24	250	langs- en afkortzagen in massief en plaat, met spaanbegrenzer	51,50
715262542	TKS250 SC	30	40	250	afkortzagen in massief en plaat, spaanloos zagen van plaat, kunststof, met geluidsreducerende laserlijn	73,00
715262581	TKS250 SC	30	80	250	afkortzagen in massief en plaat, spaanloos zagen van plaat, kunststof, met geluidsreducerende laserlijn	103,00
715263128	TKS315 Pro /TKS315E / FKS315-1500E/FKS315-2000E	30	28	315	langs- en afkortzagen in massief en plaat, met spaanbegrenzer	56,50
715263148	TKS315 Pro /TKS315E / FKS315-1500E/FKS315-2000E	30	48	315	afwerken en zagen van massief en plaat	92,50
715263160	TKS315 Pro /TKS315E / FKS315-1500E/FKS315-2000E	30	60	315	afwerken en zagen van massief en plaat	96,90



Formaatzaagmachine FKS315-1500E.

- Robuuste formaatzaag met loopwagen.
- Precieze, rolgelagerde loopwagen met telescopische armsteun, voor zaaglengtes tot 1220mm.
- Zware gietijzeren tafel voor vibratiearm werken.
- Hoekaanslag van -45 tot +45° zwenkbaar met lensvergroting voor precieze aflezing.
- Zaagblad van 0 tot 45° neigbaar via draaiknop op tandlat.
- Achteraanslag op loopwagen voor gemakkelijk doorvoeren van zware stukken.
- Zaagblad in hoogte instelbaar met handwiel.
- Tafelverlenging en verbreding meegeleverd.
- Grote centrale afzuigmond ø 100mm.
- Zaagbladbescherming met afzuigmond ø 38mm.
- Aluminium parallelaanslag met fijninstelling.
- Sterke motor 2,2 kW met 2 noodstopknoppen.
- Zonder zaagblad.

Orig. nr.		715900315 M
Orig. nr.		FKS315-1500E
Spanning	V	3x400
Diameter zaagblad	mm	315
Afmetingen werktafel (l x b)	mm	680x580
Toerental	tpm	4250
Vermogen motor	kW	2,2
Diameter afzuiging	mm	38/100
Maximum zaagbreedte met aanslag	mm	940
Maximum zaaghoogte	mm	100/75
Gewicht	kg	243,00
Prijs	€	2.039,00

Holzstar



Formaatzaagmachine FKS315-2000E.

- Robuuste formaatzaag met loopwagen.
- Precieze, rolgelagerde loopwagen met telescopische armsteun, voor zaaglengtes tot 2000mm.
- Hoekaanslag van -45 tot $+45^\circ$ zwenkbaar met lensvergroting voor precieze aflezing.
- Zaagblad van 0 tot 45° neigbaar via draaiknop op tandlat.
- Zware gietijzeren tafel voor vibratiearm werken.
- Tafel met oplegrol en telescopische arm.
- Hoekaanslag met excenterspanner zijn verschuifbaar over de ganse lengte van de loopwagen.
- Achteraanslag op loopwagen.
- Zaagblad in hoogte instelbaar met handwiel.
- Tafelverlenging en verbreding voor zaagbreedtes tot 1200mm.
- Grote centrale afzuigmond \varnothing 100mm.
- Zaagbladbescherming met afzuigmond \varnothing 38mm.
- Aluminium parallelaanslag met fijninstelling.
- Sterke motor 4 kW voor een constante zaagsnelheid.
- Met 2 noodstopknoppen.
- Zonder zaagblad.

Order nr.	715900317 ^M	
Orig. nr.	FKS315-2000E	
Spanning	V	3x400
Diameter zaagblad	mm	315
Afmetingen werktafel (l x b)	mm	600x800
Toerental	tpm	4500
Vermogen motor	kW	4
Diameter afzuiging	mm	38/100
Maximum zaagbreedte met aanslag	mm	1200
Maximum zaaghoogte	mm	100/75
Gewicht	kg	307,00
Prijs	€	2.659,00



HWS550



HWS700

Brandhoutwipzaag. Stabiele en vlot scharnierende slede met aanslagdemping en hulpveer. De gesloten zaagbladbescherming zorgt ervoor dat de machine stiller en stabiel is. Speciale motorrem met ingebouwde sensor die de temperatuur op de motor meet. Schakelaar/stekker combinatie met onderspanningbeveiliging. Gemakkelijk te verplaatsen door de grote wielen en uitschuifbare handgrepen. Krachtige elektromotor. Hoogwaardige poederlak verflaag. Standaard geleverd met chroomstaal zaagblad.

Model HWS700Z is uitgerust met cardanasaansluiting. Voor uw veiligheid: Het zaagblad is rondom afgeschermd door een stevige beschermkap. De gestante weerhaken in de slede zorgen ervoor dat het hout zich niet kan draaien tijdens het zagen. De machine is voorzien van blokkeerbouten voor een veilige zaagbladwissel. Afsluitbare noodschakelaar met onderspanningbeveiliging zodat de machine niet automatisch opnieuw begint te werken na een stroomuitval.

Order nr.	715960501	715960700	715960703	715960704	715960705
Orig. nr.	HWS550	HWSE700	HWS700	HWS700-230V	HWS700Z
Spanning	V	230	3x400	3x400	3x220
Diameter zaagblad	mm	550	700	700	700
Werkhoogte	mm	960	960	840	840
Toerental	tpm	1550	1420	1450	1450
Vermogen motor	kW	3	5,2	5,5	5,5
Type motor		Electro	elektro	Elektro	Elektro
Capaciteit rondhout	mm	180	220	220	220
Snijsnelheid	m/sec	76	53	53	53
Gewicht	kg	80,00	97,00	120,00	120,00
Afmetingen (l x b x h)	mm	1100 x 660 x 1060	725 x 1050 x 1080	1330 x 730 x 1130	1330 x 730 x 1130
Prijs	€	1.079,00	929,00	1.199,00	1.529,00



Zaagbladen voor brandhout wipzagen HWS

Order nr.	Voor type	Vertanding	Kwaliteit	Prijs €
715970155	HWS550	36	HM widia	134,00
715970055	HWS550	56	HSS	82,50
715970070	HWS700-HWSE700	56	HSS	100,00
715970170	HWS700-HWSE700	42	HM widia	159,00

Freesmachines

Holzstar

NEW



met riemen instelbare snelheden

kantelbare freeskop



Freesmachine met loopwagen en zwenkbare freesspindel.

- Aluminium loopwagen voor gemakkelijk doorvoeren van werkstukken
- Zware gietijzeren tafel met grote werkoppervlakte
- Gietijzeren freesas, zwenkbaar van +5° tot -45°
- Draairichting freesmotor rechts of links
- Variabel toerental met wisselbare riemen
- Freesaanslag met fijninstelling
- Neerhouder voor veilige werkstukgeleiding
- Met hoekaanslag en afdekkap

Order nr.		715902000 
Orig. nr.		TF200E
Spanning	V	3x400
Vermogen motor	kW	3,9
Diameter spindel	mm	30
Spindel neiging	°	+5 tot -45
Lengte spindel	mm	100
Werkhoogte	mm	900
Maximum diameter gereedschap	mm	180
Toerental	tpm	1800/3000/6000/9000
Afzuigmond	mm	100
Afmetingen loopwagen	mm	1000 x 2400
Gewicht	kg	218,00
Prijs	€	2.349,00

Houtsplitters

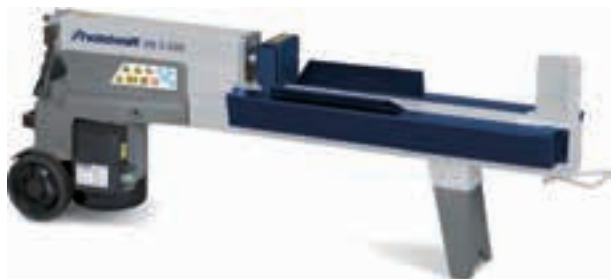

Compacte houtsplitter. Voor het splijten van lange en korte houten blokken. Gemakkelijk (met beide handen) te bedienen. Sneller werken door traploos instelbare terugloopafstand, en ingebouwde houtklem. Gelast splijtmes met maximale stabiliteit. Krachtige elektromotor. Gemakkelijk transporteerbaar Model HS7 met tussentafel voor variërende lengtes, en wielenset.

HS5-520: Horizontaal en verticaal bruikbaar.

Order nr.		715981105 ^M	715981117 ^M
Orig. nr.		HS5-520	HS7-1000
Spanning	V	230	230
Maximum splitkracht	T	5	7
Maximum splitslag	mm	320	480
Maximum splitlengte	mm	520	1040
Afmetingen tussentafel	mm		590-780-1040
Slag vooruitloop	cm/s	3	3
Slag terugloop	cm/s	8	8
Vermogen motor	kW	1,5	1,5
Gewicht	kg	50,00	115,00
Afmetingen (l x b x h)	mm	1200 x 260 x 485	830 x 930 x 1470
Prijs	€	389,00	759,00

MACHINES



Voet voor HS5-520H voor horizontaal gebruik van de splitter.

Order nr.		715991105 ^M
Afmetingen (l x b x h)	mm	155 x 16 x 3
Prijs	€	51,00

Draaibanken



Compacte houtdraaibanken voor tal van toepassingen. Stabiele staal/gietijzeren constructie met 230V motor.

- DB 450 : 4 versnellingen tussen 500 en 3.150 T/min. Met indicatie van toerental. Eenvoudig verstelbare beitelsteun met snelspanner.

Standaard geleverd met: Houder voor gereedschap 15 mm, vlakschijf diameter 7 cm, meelopend center.

- DB 900: Traploos regelbaar toerental van 500 tot 2000 t/min, met digitale aanduiding van het toerental, het motorblok met de spindel kan tot 180° zijdelings gedraaid worden, motorbalk door middel van snelspanner op het machinebed vastgemaakt.

Standaard geleverd met: Houder voor gereedschap 30 mm, vlakschijf diameter 15 cm, meelopend center en machinevoet.

Order nr.		715920450 ^M	715920900 ^M
Orig. nr.		DB450	DB900
Spanning	V	230	230
Centerhoogte	mm	127	153
Centerafstand	mm	450	900
Losse kop	MK	2	2
Maximum draaidiameter	mm	254	306
Type draad op spindel	M	33x3.5	33x3.5
Toerental	tpm	500-3150	500-2000
Versnellingen		4	10 + vario
Gewicht	kg	35,00	85,00
Afmetingen (l x b x h)	mm	820 x 300 x 430	1380 x 330 x 370
Prijs	€	279,00	539,00



Vario 500-2000 tpm



draaibare kop

Houtdraaibank voor professioneel gebruik. Stabiele staal/gietijzeren constructie. Krachtige 230 V motor. Traploos regelbaar toerental van 500 tot 2000 t/min. Met digitale aanduiding van het toerental. Het motorblok met de spindel kan tot 180° zijdelings gedraaid worden. De losse kop wordt door middel van een snelspanner op het machinebed vastgemaakt. Standaard geleverd met: Houder voor gereedschap 30 mm, vlakschijf diameter 15 cm, meelopend center en machinevoet.

Order nr.		715921100
Orig. nr.		5921100
Spanning	V	230
Centerhoogte	mm	179
Centerafstand	mm	1100
Losse kop	MK	2
Maximum draaidiameter	mm	358
Type draad op spindel	M	33x3.5
Toerental	tpm	500-2000
Versnellingen		10 + vario
Vermogen motor	kW	0,75
Gewicht	kg	92,00
Afmetingen (l x b x h)	mm	1620 x 340 x 430
Prijs	€	759,00



draaibare kop - optionele steun



snel wisselen van de riem



variabel toerental

Houtdraaibank voor professioneel gebruik. Stabiele en vibratiearme gietijzeren voet, bed, gereedschapshouder en tegenpunt. Volledige bedbreedte is bruikbaar. Oplegstuk met snelspanhendel. Krachtige motor. Toerental traploos regelbaar van 0-1.200rpm en 0-3.200rpm over 2 mechanische sneheden met riemen. Eenvoudige riemenwissel. Digitale aanduiding van het toerental. Het motorblok met de spindel kan tot 180° zijdelings gedraaid worden. Standaard geleverd met: gereedschapshouder, vlakschijf diameter 15 cm, meelopend center en machinevoet.

Order nr.		715921200
Orig. nr.		5921200
Spanning	V	230
Centerafstand	mm	1185
Losse kop	MK	2
Maximum draaidiameter	mm	460
Type draad op spindel	M	33x3,5
Toerental	tpm	0-3200
Versnellingen		2 + vario
Vermogen motor	kW	1,5
Gewicht	kg	185,00
Afmetingen (l x b x h)	mm	2060 x 500 x 1200
Prijs	€	1.949,00



Kopiëtoestel met kopieermes voor het herhalen van bewerkingen. Voor houtdraibanken DB.

Order nr.	715931101 ^M	715931102 ^M	715931060 ^M
Voor type	DB 900	DB1100	DB1200
Maximum draaidiameter mm	306	210	210
Prijs	€ 199,00	179,00	369,00



8-delige beitelset voor houtdraibanken DB.

- 3 x holbeitel
- 1 x afsteeksleutel
- 1 x rondbeitel
- 2 x rechte draaibeitel
- 1 x schraapstaal

Order nr.	715931011 ^M
Prijs	€ 89,00



Klawuuplaat 4 klauwen voor houtdraibanken DB. Set1*: met schroefinzet. Set2*: met schroefinzet en wisselklauwen.

Order nr.	715931020 ^M	715931021 ^M	715931023 ^M
Type	klauwen onafhankelijk	zelfcenterende klauwen	wisselklauwen met schroefinzet
Diameter mm	150	100	100
Aansluiting	M33x3,5 buiten 42-	M33x3,5 buiten 51-	M33x3,5 buiten 50-
Opspancapaciteit	157mm - binnen 22-59mm	78mm - binnen 40-63mm	90mm - binnen 38-73mm
Prijs	€ 49,00	82,00	109,00



Set meenemers voor houtdraibanken. 3st. in set. Opname MK2.

Order nr.	715931056 ^M
Prijs	€ 44,00



Vaste bril voor houtdraibanken DB

Order nr.	715931030 ^M	715931050 ^M
Voor type	DB1100	DB900
Prijs	€ 34,00	35,00



Hoekaanslag LLB 16H

Order nr.	715336718 ^M
Prijs	€ 123,00

Stof- & spaanderzuigers



STOFZUIGERS
p. 658



ASA1051



ASA2403



ASA3303



ASA4003

Stof- en spaanderafzuiger. Stofafzuiging laat houtbewerkingsmachines beter presteren, en bezorgt u een gezonde werkomgeving. Geschikt voor frees-, schaaft- en zaagspaaners. Verplaatsbaar op wielen. Uit staalplaat. Ventilatorschroef uit metaal, in schoepenvorm voor een verhoogde zuigkracht. Gering stofgehalte door dubbel geweven filterzak cat G1. Optionele fijnstoffilter beschikbaar. Snelspanbevestiging voor filter- en spaanderzak.

Order nr.	715121051	715122401	715122403	715122052	715123303	715123304	715124003	
	M	M	M	M	M	M	M	
Orig. nr.	ASA1051	ASA2401	ASA2403	5122403-3X230	ASA3303	ASA3303-3X220	ASA4003	
Spanning	V	230	230	3x400	3x220	3x400	3x220	3x400
Maximum volumestroom	m ³ /h	1140	2464	2464	2464	3540	3540	3686
Maximum onderdruk	PA	680	1250	1250	1250	2000	2000	3100
Filteroppervlak	m ²	1,3	1,8	1,8	1,8	2x3,6	2x3,6	4,6/2x2,3
Filtercategorie		G1	G1	G1	G1	G1	G1	G1
Volume spaanderzak	l	100	160	160	160	2x160	2x160	2x270
Aansluiting slang	mm	100	100+120	100+120	100+120	100+2x120	100+2x120	100+3x120
Aansluiting aan toestel	mm	100	200	200	200	180	180	200
Vermogen motor	kW	0,75	1,1	1,1	1,1	1,5	1,5	2,2
Geluidsniveau	dB(A)	75	80	80	80	85	85	88
Gewicht	kg	36,00	43,50	43,50	45,00	57,50	57,00	79,50
Afmetingen (l x b x h)	mm	750 x 380 x 1850	900 x 480 x 2100	900 x 480 x 2100	900 x 480 x 2100	1440 x 480 x 2200	1440 x 480 x 2200	1680 x 580 x 2800
Prijs	€	359,00	509,00	509,00	559,00	829,00	779,00	929,00



Stof- en spaanderafzuiger. Stofafzuiging laat houtbewerkingsmachines beter presteren, en bezorgt u een gezonde werkomgeving. Geschikt voor frees-, schaaft- en zaagspaanders. Verplaatsbaar op wielen. Uit staalplaat. Ventilatorschroef uit metaal, in schoepenvorm voor een verhoogde zuigkracht. Gering stofgehalte door dubbel gewezen filterzak cat G1. Snelspanbevestiging voor filter- en spaanderzak. Optionele fijnstoffilter beschikbaar.

Order nr.		715125403
Orig. nr.		ASA5403
Spanning	V	3x400
Maximum volumestroom	m ³ /h	5377
Maximum onderdruk	PA	4500
Filteroppervlak	m ²	6
Filtercategorie		G1
Volume spaanderzak	l	2x450
Aansluiting slang	mm	100+3x120
Aansluiting aan toestel	mm	250
Vermogen motor	kW	3,7
Gewicht	kg	111,00
Afmetingen (l x b x h)	mm	1900 x 670 x 2800
Prijs	€	1.439,00



Accessoires voor industriële stofzuigers ASA. VE = verpakkingseenheid.

Order nr.	Omschrijving	VE	Min. bestelhoeveelheid	Prijs/VE €
715121052 M	filterzak ASA1051 - 970x580	1	1	34,00
715122054 M	fijnstoffilter ASA2401/2403/2051/2053/3053/5053 - 1170x660	1	1	42,00
715122554 M	filterzak ASA3303/2553	1	1	48,00
715123054 M	filterzak ASA4003/3053 - 1200x705	1	1	72,00
715125054 M	filterzak ASA5403/5053 - 1400x955	1	1	145,00
715121053 M	pvcspaanderzak ASA1051 - 970x600 (per st.)	1	10	2,60
715122055 M	pvcspaanderzak ASA2401/2403/2051/2053/2553/3303 - 650x1140x0,200 mm	1	10	2,50
715125055 M	spaanderzak ASA5403/5053 - 970x1350 mm	1	10	4,00
715123055 M	spaanderzak ASA4003/3053 - 810x1200x0,200 mm	1	10	3,00
715121054 M	filterpatroon ASA1051	1	1	225,00
715122005 M	verdeelstuk (ASA 2053/2553) 1x120 / 1x80 mm	1	1	30,00
715122006 M	verdeelstuk (ASA 2053/2553) 1x120 / 1x60 mm	1	1	30,00
715122007 M	verdeelstuk (ASA 4003/5403) 2x120 / 1x100 / 1x80 mm	1	1	45,00
715122008 M	verdeelstuk (ASA 4003/5403) 2x120 / 1x100 / 1x60 mm	1	1	45,00
715141212 M	spaanderzak RLA - 710x1240 mm	1	1	45,00



Fijnstoffilters voor ASA stof- spaanderzuigers. Polyestervliesfilter in filtercategorie USGC. Sterke filter met langere standtijd dan normale zakfilters. VE = verpakkingseenheid.

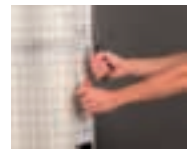

Order nr.	Omschrijving	Manuele reiniging	Prijs €
715121054 M	filterpatroon ASA1051	x	225,00
715122056 M	fijnstoffilter ASA 2051/2053/2553/2401/2403/3303	✓	395,00
715123056 M	fijnstoffilter ASA 3053/4003	✓	439,00
715125056 M	fijnstoffilter ASA 5053/5403	✓	439,00

Aanloepschakelaar. Ideaal in combinatie met een stofafzuiger.

ALA10: Automatisch starten en stoppen van de stofafzuiger.
ALA2: Deze schakelaar schakelt een tweede toestel automatisch in, bij het opstarten van een eerste toestel.



Order nr.		715121502 M	715121501 M
Spanning	V	2 x 230 - 400	2 x 230 - 2 x 400
Vermogen motor	kW	3,6	4
Prijs	€	164,00	-



NEW



LED display



spaanderbak met venster

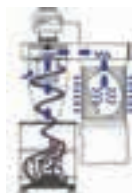

cycloon techniek

Cycloon-spaan- en stofzuigers. Bestemd voor afzuiging van grove spaanders in groot volume van schaafbanken, freesbanken, ...

- Sterke, impactbestendige stalen behuizing voor inzet in productie.
- Hoogefficiënte filterzak met speciale oppervlaktecoating.
- Filtercategorie C.
- Wrijvingsloze en snelle spaanderzakwissel

RLA 1614

- Automatische filterreiniging, zodat spaanders weervallen in de zak.
- Spaanderbox met zichtvenster.

RLA 1619/ RLA 2026

- Automatische filterreiniging met sensorherkenning, voor optimaal gebruik zonder tijdverlies.
- Spaanderbox met zichtvenster

Order nr.		715135160 ^M	715135161 ^M	715135200 ^M
Orig. nr.		RLA1614	RLA1619	RLA2026
Spanning	V	230	400	400
Vermogen motor	kW	1,1	1,5	2,25
Debiet	m ³ /u	1400	1937	2601
Maximum onderdruk	PA	1742	1991	2489
Filtercategorie		C	C	C
Volume spaanderzak	l	146	218	218
Gewicht	kg	115,00	172,00	172,00
Afmetingen (l x b x h)	mm	965 x 675 x 1829	965 x 754 x 2039	965 x 754 x 2039
Prijs	€	1.929,00	2.359,00	2.535,00



overzichtelijke LED display

Intelligent luchtfiltersysteem voor ophanging in de werkplaats. Filtert stof en verontreinigingen uit de lucht.

- Overzichtelijk LED-display en bedieningspaneel.
- Standaard met Elektrostatische filter die kleine deeltjes efficiënt en snel uifiltert.
- Met afstandsbediening met timer voor automatische uitschakeling.
- Automatische aanduiding van filterstatus beperkt vroegtijdige filterwissels.
- Filtert deeltjes uit groter dan 1 µm.
- 3 filtersnelheden afhankelijk van de gebruikintensiviteit.
- Met 4 ophangbeugels.

Voorbeeld: aangeraden verversingsgraad voor enkele ruimtes:

- Montagehal: 4-8x/u
- Labo: 8-15x/u
- Verfspuitlokaal: 25-50x/u

Order nr.		715127003 M
Orig. nr.		LFS3
Luchtdebiet	m ³ /u	846/1184/2030
Vermogen motor	W	150
Spanning	V	230
Gewicht	kg	23,00
Prijs	€	409,00

Accessoires voor luchtfiltersysteem LFS3.

Order nr.		715127004 M	715127005 M
Orig. nr.		5127004	5127005
Omschrijving		prefilter	zakfilter
Gewicht	kg	1,00	1,00
Prijs	€	14,00	34,00

Aanvoerapparaten





NEW

Aanvoerapparaat VSA 38EL 0.75kW 400V voor aan- en doorvoer van houten balken en planken.

- 3 aandrijfrollen
- 8 snelheden
- 750W/3x400V
- Metalen behuizing
- rol-ø 120mm
- rolbreedte 60 mm

Order nr.	715114501 ^M	
Orig. nr.	VSA38EL	
Aantal snelheden	8	
Aantal aandrijfrollen	3	
Spanning	V	3x400
Vermogen	W	750
Diameter rol	mm	120
Rollengte	mm	60
Behuizing	metaal	
Prijs	€	839,00





NEW

Aanvoerapparaat VSA 48L 0.75kW 230V voor houten balken en panelen.

- Horizontaal en verticaal gebruik
- 4 aandrijfrollen
- 8 snelheden
- 750W/3x400V
- Max. Uitlading: 1050 mm
- Metalen behuizing
- Rol-ø 120mm
- Rolbreedte 60 mm

Order nr.	715115523 ^M	
Orig. nr.	VSA48L	
Aantal snelheden	8	
Aantal aandrijfrollen	4	
Spanning	V	3x400
Uitlading	mm	1050
Diameter rol	mm	120
Rollengte	mm	60
Behuizing	metaal	
Prijs	€	939,00





NEW

Aanvoerapparaat VSA32 0.18kW 400V voor houtbewerking.

- 3 aandrijfrollen
- 4 snelheden
- max. Uitlading: 300 mm
- 180W/3x400V
- rol-ø 80mm
- rolbreedte 30 mm

Order nr.	715111000 ^M	
Orig. nr.	VSA32	
Aantal snelheden	4	
Aantal aandrijfrollen	3	
Spanning	V	3x400
Uitlading	mm	300
Vermogen	W	180
Diameter rol	mm	80
Rollengte	mm	30
Behuizing	metaal	
Prijs	€	519,00





NEW

Professioneel aanvoerapparaat voor houtbewerking.

- Traploos instelbare doorvoersnelheid 2-17m/min.
- Slimme instelhandel voor het wegzwenken van de arm MEMO-LOCK: altijd een geschikte positie
- Horizontaal of verticaal gebruik
- Gemakkelijke instelling 90°/180° met het AUTO-LOCK-System
- Standaard met lange statiefarm
- Links en rechts doorvoeren
- duurzame PU aandrijfrollen

Order nr.	715116300 ^M	
Orig. nr.	VSA300	
Aantal aandrijfrollen	4	
Spanning	V	3x400
Uitlading	mm	1050
Vermogen	W	560
Diameter rol	mm	120
Rollengte	mm	60
Behuizing	metaal	
Prijs	€	1.999,00



Werkbanken

Protskraft



Houten werkbank in massieve beuk voor semi-professioneel gebruik of voor de hobbyist. Geleverd met 4 bankhaken, 2 rijen gaten en 2 houtklemmen. Ongemonteerd geleverd. Model HB2004 geleverd met 1 voorklem en 1 zijklem. Geolied bovenblad.

Order nr.		715101411 M	715101911 M	715102019 M
Orig. nr.		HB1401	HB1901	HB2004
Plaatdikte	mm	30	30	40
Gewicht	kg	47,00	55,00	87,00
Afmetingen (l x b x h)	mm	1350 x 500 x 820	1980 x 650 x 820	2120 x 760 x 860
Prijs	€	429,00	459,00	829,00

Houtbewerkingsmachines



- Rondbankhaken die het opspannen van verschillende werkstukken verlichtert.

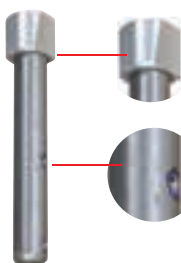

- Spankop uit aluminium. Verhinderd beschadigingen aan werkstuk.
- De zijdelings schuine spanvlakken van de ronde kop drukken bij het spannen het werkstuk gelijkmatig naar beneden tegen het werkvlak
- Via de instelbare drukelementen kunne de rondbankhaken op verschillende hoogtes worden ge-positioneerd.



- Duitse zijklem.
- Met nieuwe spelvrije naregelbare geleiding uit staal op U-ijzerprofiel.
- Met lichtlopende trapeziumdraadspindel



- Getemperde, massieve beukenhouten werkplaat vertand verlijmd voor de hoogstmogelijke stevigheid van de houtverbinding



- Standaard met zorgvuldig afgewerkte werktuiggleuf. Alle belangrijke kanten afgerond.

HB2007



Professionele werkbank voor schrijnwerkers. Vervaardigd uit gestoomde beuk, met afgeronde hoeken en stevig geelid bovenblad (50mm). Zijklemmen, voorklem met stabiele gietijzeren lineaire geleiding en gemakkelijk te bedienen hendel. Zijklem met vingerlasverbindingen.

Met 2 korte en 2 lange bankhaken die het opspannen van werkstukken met speciale vormen vergemakkelijkt (driehoeken, ronde vormen, ...).

Bankhaakkoppen uit zacht aluminium, wat beschadiging aan het werkstuk vermindert. De schijn aflopende koppen zorgen voor de optimale klemming. Door de zijdelingse rij kogels, zijn de bankhaken gemakkelijk in hoogte regelbaar.

Order nr.	715102070 	
Orig. nr.	HB2007	
Plaatdikte	mm	50
Lengte werkblad	mm	1915x615
Lengte voorklem/achterklem	mm	520x450
Breedte voorklem/achterklem	mm	55x15
Verspreiding voorklem/achterklem	mm	165x190
Werkhoogte	mm	870
Gewicht	kg	85,00
Afmetingen (l x b x h)	mm	2000 x 650 x 820
Prijs	€	889,00

Holzstaff



NEW

PROFI-UITVOERING



massieve lineaire geleiding

Professionele werkbank voor schrijnwerkers in zware uitvoering. Vervaardigd uit gestoomde beuk, met afgeronde hoeken en geolied stevig bovenblad (50mm). Met onderlade en materiaalvak. Zijklem en voorklem met zeer zware en stabiele gietijzeren lineaire geleiding en gemakkelijk te bedienen hendel. Zijklem met zwaluwstaartverbindingen.

Met 2 korte en 2 lange bankhaken die het opspannen van werkstukken met speciale vormen vergemakkelijkt. (driehoeken, ronde vormen, ...)

Bankhaak koppen zijn uit zacht aluminium, wat beschadiging aan het werkstuk vermijdt. De schuin aflopende koppen zorgen voor de optimale klemming. door de zijdelingse rij kogels, zijn de bankhaken gemakkelijk in hoogte regelbaar.

Order nr.		715102102 M
Orig. nr.		HB2010
Plaatdikte	mm	50
Werkoppervlak (zonder bankschroef)	mm	1910x615
Lengte voorklem/achterklem	mm	520/460
Breedte voorklem/achterklem	mm	170/190
Verspreiding voorklem/achterklem	mm	50x110
Werkhoogte	mm	870
Gewicht	kg	85,00
Afmetingen (l x b x h)	mm	2000 x 650 x 820
Prijs	€	929,00



Accessoires voor HB2006.

Order nr.		715102151 M	715102152 M
Orig. nr.		5102151	5102152
Omschrijving		Set van 2 lange haken	Set van 2 korte haken
Gewicht	kg	1,00	1,00
Prijs	€	72,00	68,00



Rollenbanen



Inklapbare en veelzijdige werktafel en rollenbaan met snelklemstelsysteem. Geschikt voor schuurmachines, afkortzagen, enz. Stabiele alu-stalen constructie. Gemaakt voor lange werkstukken. Wordt opgebouwd zonder werktuigen. Plaatsbesparend dankzij de inklapbare voeten. Werkstukhouders met snelklemming. In de hoogte verstelbare rollen. Aan beide zijden uitschuifbare oplegarmen tot max. 2800mm. Max. belasting 225kg.

Order nr.	715900020
Orig. nr.	UWT3200
Minimum/maximum hoogte legvlak	mm 850-1000
Maximum breedte	mm 2800
Gewicht	kg 32,00
Afmetingen (l x b x h)	mm 1600 x 600 x 850
Prijs	€ 194,00



Klemmenset (2st) voor rollenbaan UWT3200. L. 500mm.

Order nr.	715900022
Prijs	€ 24,00



Rolboksset (2st) voor rollenbaan UWT3200

Order nr.	715900025
Prijs	€ 23,00



Materiaalsteun met rol. Stabiele constructie. Traploos in hoogte verstelbaar. Eenvoudig te transporteren.

Order nr.	715900003
Orig. nr.	MS1R
Minimum/maximum hoogte legvlak	mm 700-1150
Capaciteit	kg 30
Maximum breedte	mm 390
Gewicht	kg 10,00
Afmetingen (l x b x h)	mm 135 x 500 x 810
Prijs	€ 55,00



UMS1

TAB1300

Stabiele materiaalsteun samenklapbaar en in hoogte instelbaar.

Order nr.	715900009	715900007
Orig. nr.	UMS1	TAB1300
Minimum/maximum hoogte legvlak	mm 820-1270	805-1300
Capaciteit	kg 45-200	150
Gewicht	kg 10,40	6,60
Afmetingen (l x b x h)	mm 750 x 680 x 1270	580 x 580 x 1300
Prijs	€ 59,00	28,00



Materiaalsteun met kogellagers. Stabiele constructie. Traploos in hoogte verstelbaar. Eenvoudig te transporteren.

Order nr.	715900004
Orig. nr.	MS1K
Minimum/maximum hoogte legvlak	mm 700-1150
Capaciteit	kg 30
Maximum breedte	mm 390
Gewicht	kg 12,00
Afmetingen (l x b x h)	mm 135 x 500 x 810
Prijs	€ 52,00

holzstar



Opvouw-rollenbaan.

- Zeer robuute poten uit stalen kokers
- Volverzinkte rollen
- 360° draaibare kunststof wielen met rem
- Hoogteverstelling 60-100cm
- Lengteverstelling 50-140 cm
- Gemakkelijk koppelen van meerdere rollenbanen met haaksysteem

Order nr.	715900012	
Orig. nr.	SRB130	
Minimum/maximum hoogte legvlak	mm	670-970
Capaciteit	kg	130
Gewicht	kg	36,00
Afmetingen (l x b x h)	mm	1480 x 670 x 970
Prijs	€	235,00

holzstar



Opvouwbaar schraag. Gemakkelijk transport. Met kunststoffen draagbeugel.

Order nr.	715900006	
Orig. nr.	FAB1	
Minimum/maximum hoogte legvlak	mm	640-1030
Capaciteit	kg	360
Gewicht	kg	8,30
Afmetingen (l x b x h)	mm	970 x 620 x 1030
Prijs	€	34,00

holzstar



Zaagschraag.

Order nr.	715900008	
Orig. nr.	SB1	
Minimum/maximum hoogte legvlak	mm	780
Capaciteit	kg	180
Gewicht	kg	7,60
Afmetingen (l x b x h)	mm	800 x 850 x 780
Prijs	€	30,00

holzstar



Samenplooibare materiaalsteun met rol. Traploos in hoogte verstelbaar.

Order nr.	715900005	
Orig. nr.	MS3R	
Minimum/maximum hoogte legvlak	mm	670-1150
Capaciteit	kg	30
Maximum breedte	mm	285
Gewicht	kg	4,00
Afmetingen (l x b x h)	mm	430 x 500 x 1150
Prijs	€	24,00

holzstar



Multifunctionele werktafel, instelbaar in hoogte en onder hoek 0°, 25°, 45° en 80°.

Altijd een ergonomische positie zowel staand als zittend. Werkklem met 8 kunststof traploos instelbare spanbekken in verschillende profielvormen. Vele klemvormen mogelijk: vlak, rond, verticaal of horizontaal. Plaatsbesparend samenklapbaar. Sterke werkoppervlak in staal en alu.

Buisprofielen gelakt onderstel met gummivoetjes.

Order nr.	715900010	
Orig. nr.	KWB100	
Minimum/maximum hoogte legvlak	mm	770-1070
Capaciteit	kg	100
Maximum breedte	mm	410
Lengte werkblad	mm	600
Gewicht	kg	13,70
Prijs	€	170,88

STANLEY

INVERTER PROGRAMMA

Voordelen van de Inverter

- Lichter
- Stabiele uitgangsstroom
- Efficiënt brandstofverbruik
- Bediening voor gevoelige apparaten (televisie, computer, meetinstrumenten, ...)

GENERATOR PROGRAMMA

Het gamma Stanley generatoren en inverters omvat een selectie van 6 generatoren en inverters voor zowel professionele als occasionele gebruikers. Er werd gekozen voor generatoren die milieuvriendelijk, gebruiksvriendelijk en betaalbaar zijn. Dankzij moderne en efficiënte productietechnieken werd dit mogelijk gemaakt, en voldoen de Stanley generatoren aan alle geldende veiligheidseisen.



Generatoren

INVERTER

GESCHILT VOOR ELEKTRONICA



SIG2000



MET GROTE TANK

OP WIJLEN

SIG3050

Het gamma STANLEY generatoren omvat een selectie van 6 generatoren en inverters voor zowel professionele als occasionele gebruikers.

Er werd gekozen voor generatoren die milieuvriendelijk, gebruiksvriendelijk en betaalbaar zijn. Dankzij moderne en efficiënte productietechnieken werd dit mogelijk gemaakt, en voldoen de STANLEY generatoren aan alle geldende veiligheidsisen.

Compacte inverter generatoren met stabiele uitgangsspanning. Bestemd voor gebruik met spanningsgevoelige elektrische toestellen zoals computers, meettoestellen, TV, ... Lichte en draagbare toestellen.

Koperen windingen en luchtgekoelde benzinemotor met manuele startkoord.

Automatische regeling en controle van het voltage. 2 stekkers 230V. Met beveiliging tegen overbelasting en lage oliestand.

CE conform. Urenteller.

SIG3050 met grote ingebouwde benzinetank van 14 liter die een grote autonomie van 14 uur waarborgt.

Order nr.		855082000	855083050
Orig. nr.		SIG2000	SIG3050
Spanning	V	230	230
Start		Manueel	Manueel
Type motor		Benzine - 4-takt	Benzine - 4-takt
Maximum vermogen	kW	2	3
Continu vermogen	kW	1,8	2,8
Wikkelingen		Koper	Koper
Maximum toerental	rpm	3600	3600
Benzine/olie tankinhoud	l	3,8/0,6	14/0,6
Autonomie (halve kracht)	u	3,8	14
Stopcontacten	V	VDE, 2x230	VDE, 2x230
Geluidsniveau	dB(A)	95 (4m)/70 (7m)	96 (4m)/71 (7m)
Op wielen		x	✓
Frequentie	Hz	50	50
Gewicht	kg	30,00	49,00
Afmetingen (l x b x h)	mm	580 x 415 x 530	525 x 480 x 555
Prijs	€	469,00	589,00

STANLEY



E-SG-2200

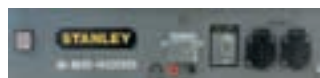

E-SG-4000



E-SG2200



E-SG4000

Generator met benzinemotor. Bestemd voor stroomverbruik tot 3,5kW.

- Aluminium of koperen (E-SG4000) windingen en luchtgekoelde motor.
- Manuele start met startkoord.
- Automatische regeling en controle van het voltage. 2 stekkers 230V en 1x12V (E-SG4000) met beveiliging tegen overbelasting en lage oliestand.
- CE conform.
- E-SG4000 met grote ingebouwde benzinetank van 25 liter die een grote autonomie van 12 uur waarborgt.

Order nr.		855082210 €	855084000 €
Orig. nr.		E-SG2200	E-SG4000
Spanning	V	230	230
Start		Manueel	Manueel
Type motor		Benzine - 4-takt	Benzine - 4-takt
Continu vermogen	kW	2	3,2
Wikkelingen		Aluminium	Koper
Maximum toerental	rpm	3600	3600
Benzine/olie tankinhoud	l	3,5/0,6	25/1,1
Autonomie (halve kracht)	u	2,7	12
Geluidsniveau	dB(A)	95 (4m)	96 (4m)
Op wielen		x	✓
Stopcontacten		VDE, 2x230	VDE, 2x230
Frequentie	Hz	50	50
Gewicht	kg	49,00	68,00
Afmetingen (l x b x h)	mm	590 x 410 x 450	700 x 520 x 570
Prijs	€	259,00	499,00



SG3000



SG5500

5,5 kW
3x230V STEKKER



SG3000



SG5500

Generatoren met benzinemotor op wielen. Tot 5,5kW.

Aluminium of koperen (SG5500) windingen en luchtgekoelde motor.

Manuele startkoord of elektrische start (SG5500).

Grote ingebouwde benzinetank die een grote autonomie waarborgt.

Automatische regeling en controle van het voltage.

2 stekkers 230V en 1x12V met voltmeter, SG5500: 3x230V + 400V stecker, beveiliging tegen overbelasting en lage oliestand. CE conform.

Order nr.		855083000 €	855085500 €
Orig. nr.		SG3000	SG5500
Spanning	V	230	230-400
Start		Manueel	Elektrisch
Type motor		Benzine - 4-takt	Benzine - 4-takt
Maximum vermogen	kW	2,7	5,5
Continu vermogen	kW	2,5	3,6
Wikkelingen		Aluminium	Koper
Maximum uitgang/toerental	pk/rpm	6,5/3600	13/3600
Benzine/olie tankinhoud	l	15/0,6	25/1,1
Autonomie (halve kracht)	u	7,2	9,15
Stopcontacten	V	VDE, 2x230	VDE, 3x230/1x400
Geluidsniveau	dB(A)	96 (4m)	97 (4m)
Frequentie	Hz	50	50
Gewicht	kg	49,00	91,00
Afmetingen (l x b x h)	mm	655 x 475 x 485	730 x 590 x 595
Prijs	€	339,00	789,00



TELWIN®

TELWIN: Technology, TELWIN: Tecnologia,



Telwin is a Company System certified according to ISO 9001:2008 and BSI OHSAS 18001:2007. Telwin means reliability, solidity, performance certified by the most important International Bodies (TÜV, GOST, UL, CSA, etc.). Telwin means **Research and Development, Technological Innovation**. All activities must aim not only for high performance, but also for reduced energy consumption and RoHs-compliant raw materials/components, within the framework of sustainable development. **Telwin: innovation for everyone's benefit.**



Telwin è un Sistema Azienda certificato ISO 9001:2008 e BSI OHSAS 18001:2007. Telwin è affidabilità, solidità, performance certificate dai più autorevoli Enti Internazionali (TÜV, GOST, UL, CSA, etc.). **Telwin è Ricerca e Sviluppo, Innovazione Tecnologica**. Tutte le attività hanno come obiettivo, oltre ad alte performances, la riduzione dei consumi energetici e l'uso di materiali/componenti secondo la normativa Rohs, in un'ottica di sviluppo sostenibile. **Telwin: innovazione a beneficio di tutti.**



Telwin est un Système d'Entreprise certifié ISO 9001:2008 et BSI OHSAS 18001:2007. El est synonyme de fiabilité, solidité, performance certifiées par les plus grands organismes internationaux (TÜV, GOST, UL, CSA, etc.). **Telwin est Recherche et Développement, Innovation Technologique**. Toutes ses activités de conception ont pour objectif, outre de hautes performances, la réduction des consommations d'énergie et l'utilisation de matériaux et de composants conformes aux normes Rohs, dans une optique de développement durable. **Telwin: l'innovation pour le plus grand avantage de tous.**



Telwin es un Sistema de Empresa certificado ISO 9001:2008 y BSI OHSAS 18001:2007. El es fiabilidad, solidez, rendimiento certificados por los entes internacionales con mas autoridad (TÜV, GOST, UL, CSA, etc.). **Telwin es Investigación y Desarrollo, Innovación Tecnológica**. Todas las actividades tienen como objetivo, ademas de altos rendimientos, la reducción de los consumos energeticos y el uso de materiales/componentes segun la normativa Rohs, dentro del marco de un desarrollo sostenible. **Telwin: innovación en beneficio de todos.**



Telwin ist ein Qualitätsmanagement, das nach ISO 9001:2008 und BSI OHSAS 18001:2007 zertifiziert ist. Sie ist Zuverlässigkeit, Solidität und Leistung, die von den renommiertesten internationalen Prüfstellen (TÜV, GOST, UL, CSA etc.). **Telwin ist Forschung und Entwicklung, Technologische Innovation, automatisierte, hochmoderne Fertigungsanlagen**. Sämtliche Tätigkeiten zielen im Rahmen einer nachhaltigen Entwicklung, nicht nur auf Leistung ab sondern auch auf die Reduzierung des Energieverbrauchs und die Verarbeitung von Materialien und Komponenten, die der Norm ROHS entsprechen. **Telwin: Innovation, die allen zugutekommt.**



Telwin - Система Предприятия, имеющая сертификацию согласно стандартам ISO 9001:2008 и BSI OHSAS 18001:2007. Telwin - это надежность, уверенность, прочность, что подтверждает организованный уровень исполнения, засертифицированный самими важными международными организациями (TÜV, GOST, UL, CSA, etc). **Telwin - это поиск Поиск и Развитие, Технологическая Инновация**, передовые производственные автоматизированные системы. Как технологический лидер, все проектные работы нацелены, кроме высокого уровня исполнения, еще и на уменьшение энергетического потребления и использование материалов/компонентов, согласно нормативам Rohs, как достижение экологического развития производства. **Telwin: инновация и польза для всех.**





Innovation, Safety...
Innovazione, Sicurezza...

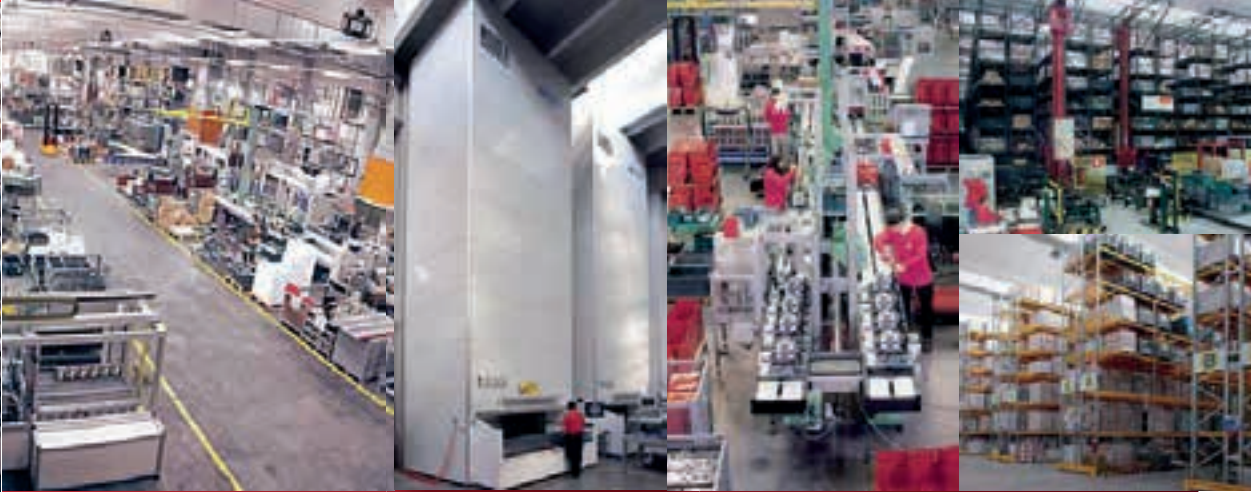

...for a better world.
...per un mondo migliore.



CERTIFIED QUALITY SYSTEM
UNI EN ISO 9001:2008



CERTIFIED SYSTEM
OHSAS 18001:2007



Choose your Battery Charger

CHARGE 15h

MAINTENANCE

START

5 min. pre charge + START

	20 Ah	60 Ah	80 Ah	100 Ah	150 Ah	200 Ah	> 250 Ah					TECHNOLOGY		
												TRONIC	PULSE TRONIC	
Charge	MOTOTRONIC 6/12	MAINTENANCE						•	•	•	•	✓		
	NEVATRONIC 12 - 24	MAINTENANCE						•	•	•	•	✓		
	AUTOTRONIC 25 BOOST	MAINTENANCE						•	•	•	•	✓		
	T-CHARGE 10	MAINTENANCE					MAINTENANCE	•	•	•	•		✓	
	T-CHARGE 12	MAINTENANCE						•	•	•	•		✓	
	T-CHARGE 18 - 20 BOOST	MAINTENANCE					MAINTENANCE	•	•	•	•		✓	
	T-CHARGE 26 BOOST	MAINTENANCE					MAINTENANCE	•	•	•	•		✓	
	NEVADA 6 - 10 - 11 - 12 - 14 - 15	MAINTENANCE						•						
	ALPINE 13 - 14 BOOST - 15	MAINTENANCE						•						
	ALPINE 18 - 20 BOOST	MAINTENANCE						•						
	ALPINE 30 - 50 BOOST	MAINTENANCE						•						
NEVABOOST 100	MAINTENANCE						•							
COMPUTER 48/2 PROF	MAINTENANCE						•							
Charge & Start	NEVABOOST 140	MAINTENANCE						•						
	BOOST & GO	START												
	DIGITRONY 230 START	START					MAINTENANCE	•	•	•	•	✓		
	DIGISTART 340	START					MAINTENANCE	•	•	•	•		✓	
	STARTRONIC 330	START					MAINTENANCE	•	•	•	•		✓	
	STARTRONIC 530	START					MAINTENANCE	•	•	•	•		✓	
	LEADER 150 START	START						•						
	LEADER 220 START	START						•						
	LEADER 400 - DYNAMIC 220 - 320 START	START						•						
	DYNAMIC 420 - 520 - 620 START	START						•						
	ENERGY 650 - 1000 START	START						•						
	ENERGY 1500 START	START						•						

	12V							24V		
	20 Ah	60 Ah	80 Ah	100 Ah	150 Ah	200 Ah	80 Ah	120 Ah	180 Ah	
Start	SPEED START 1012	START								
	SPEED START 1212	START								
	SPEED START 1812	START								
	PRO START 1712 - 2212	START								
	PRO START 2824	START								
	START PLUS 4824	START								
START PLUS 6800 - 6824	START									

Types of Batteries

GB WET Batteries: Lead-Antimony (PbSn) or Lead-Calcium (PbCa) or Lead Calcium-Silver (PbCaAg) batteries with liquid electrolyte made up of water (H₂O) and sulphoric acid (H₂SO₄). These are the most widely used batteries in the automotive sector.

F Batteries WET: Batteries au plomb-antimoine (PbSn) ou plomb-calcium (PbCa) ou plomb-calcium-argent (PbCaAg) avec électrolyte liquide constitué d'une solution d'eau (H₂O) et d'acide sulfurique (H₂SO₄). Ces batteries sont les plus courantes dans le secteur automobile.

GB GEL Batteries: Lead-Calcium batteries (PbCa) with solid gelatinous electrolyte. Given that these batteries are completely sealed, they can be positioned in different applications without running the risk of having the electrolyte leaking. Maintenance free.

F Batteries GEL: Batteries au Plomb-Calcium (PbCa) à électrolyte solide de type gélatineux, complètement hermétiques et qui peuvent être employées par conséquent dans différentes positions sans risque de fuite de l'électrolyte. Ces batteries demandent pas d'entretien.

GB AGM Batteries: These are solid (starved) electrolyte lead-calcium (PbCa) batteries in which the fibreglass plates absorb and hold the entire acid content. They are completely sealed and can therefore be used in a variety of positions with no risk of electrolyte leaks. Maintenance-free.

F Batteries AGM: Batteries au plomb-calcium (PbCa) à électrolyte solide dont les éléments en laine de verre absorbent et conservent tout l'acide contenu. Entièrement scellées, les batteries peuvent être utilisées en toutes positions sans risque de fuite de l'électrolyte. Aucun entretien nécessaire.

PulseTronic Characteristics

PulseTronic

F Contrôle automatique des étapes de charge

- Maintien de la charge par impulsions "PulseTronic" • amélioration du contrôle du maintien de la charge • protection du système électronique de bord • charge de batteries très déchargées • protection totale sans étincelles pour inversion polarité et courts-circuits • réduction du temps de chauffage de la batterie durant la charge (réduction des oscillations) • durabilité accrue des batteries.

GB Automatic control of step charging process

- Pulse charging maintenance "PulseTronic"
- greater control for holding the charge
- protection of on-board electronics
- charges very flat batteries
- total, spark-free, reverse polarity and short circuit control
- reduced heat production in battery during charging (fewer fluctuations)
- batteries last longer.

PulseTronic Models

T-Charge 10
T-Charge 12



T-Charge 20 Boost



T-Charge 18 - 26 Boost



Digistart 340



Startronic 330



Startronic 530



Serial connection - Последовательное Соединение

GB Charge voltage = Sum of each voltage in V • Batteries need to have the same capacity in Ah

RU Напряжение заряда = Сумма отдельных напряжений • Аккумуляторы должны иметь одинаковую емкость в Ампер-час

Parallel connection - Параллельное Соединение

GB Charge capacity = Sum of each capacity in Ah • Batteries need to have the same voltage in V

RU Напряжение заряда = Сумма отдельных емкостей • Аккумуляторы должны иметь одинаковое напряжение

$$1 \quad 2$$

$$12V + 12V = 24V$$

$$70 \text{ Ah} \quad 70 \text{ Ah} \quad 70 \text{ Ah}$$

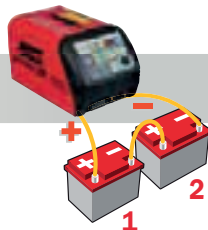

$$1 \quad 2$$

$$40 \text{ Ah} + 35 \text{ Ah} = 75 \text{ Ah}$$

$$12V \quad 12V \quad 12V$$

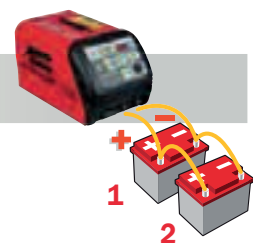

Battery Charger Status



BATTERY CAPACITY	Recommended Charge Current					
	WET		GEL/AGM		Ni - Cd	
Ah	Normal	Rapid	Normal	Rapid	Normal	Rapid
20	2 A	10 A	5 A	10 A	2A	10A
60	5 A	20 A	5 A	20 A	5A	20A
100	10 A	40 A	20 A	40 A	10A	30A
150	10 A	40 A	30 A	40 A	10A	40A
200	20 A	40 A	40 A	40 A	20A	40A





Intelligente elektronische batterijladers &- starters



Pulse-Tronic



T-CHARGE 10



T-CHARGE 12



T-CHARGE 26

Intelligente elektronische batterijladers. Continue controle van de laadstroom en druppelladen. Ontworpen voor het laden van alle soorten batterijen (GEL/WET/AGM/START-STOP). Spanning van 12V voor moto's, auto's en bestelwagens. T-CHARGE 20 : 12/24V. Met batterij-indicator tijdens het laden. Bescherming tegen kortsluiting van de uitgaande kabels of verkeerde polariteit. Geleverd met 3 types van kabels.

De PULSE-TRONIC technologie : Elektronische sturing voor een langere levensduur van de batterijen door o.a. constante laadcontrole en optimalisatie, gereduceerde laadtemperatuur, bescherming van boordinstrumenten en laden van bijna lege batterijen. IP54. Spatwaterdicht.

Order nr.		830807559 €	830807560 €	830807561 €	830807563 €	830807562 €
Orig. nr.		T-CHARGE10	T-CHARGE12	T-CHARGE18BOOST	T-CHARGE20BOOST	T-CHARGE26BOOST
Spanning	V	230	230	230	230	230
Laadspanning	V	12	12	12	12/24	12
Laadstroom	A	2	4	8	8	16
Referentiecapaciteit	Ah 15h (min/max)	5/50	2/70	5/180	5/180	10/250
Opgenomen vermogen	kW	0,04	0,055	0,11	0,11	0,22
Gewicht	kg	0,36	0,60	1,10	1,28	1,38
Afmetingen (l x b x h)	mm	135 x 65 x 48	170 x 65 x 35	300 x 95 x 55	300 x 95 x 55	300 x 95 x 55
Prijs	€	35,90	57,90	86,50	92,90	120,00



Intelligente elektronische batterijlader. Voor lood, gel, AGM en start-stop batterijen in 12 en 24 V. Digitaal display voor stroom/spanning. Test functie (via display): normaal en snellader met Boost functie.

Order nr.		830807568 €
Orig. nr.		DIGITRONY 230
Spanning	V	230
Laadspanning	V	12/24
Laadstroom	A	20
Startstroom	Max. A cc	180
Referentiecapaciteit	Ah 15h (min/max)	30/400
Opgenomen vermogen	kW	0,8/3,6
Instelposities laadstroom		2
Gewicht	kg	9,50
Afmetingen (l x b x h)	mm	225 x 290 x 205
Prijs	€	259,00

Digitale batterijlader en starter voor lood, Gel, AGM en start-stop batterijen in 12 en 24 V. Zware type starter voor personenwagens en lichte bestelwagens. Digitaal display voor stroom/voltage. Test functie. PULSE-TRONIC : Elektronische sturing voor een langere levensduur van de batterijen door o.a. constante proces-controle en optimalisatie, gereduceerde laadtemperatuur, bescherming van boordinstrumenten en laden van bijna lege batterijen.



Order nr.	830829327 E	
Orig. nr.	DIGISTART 340	
Spanning	V	230
Laadspanning	V	12/24
Laadstroom	A	30
Startstroom	Max. A cc	300
Referentiecapaciteit	Ah 15h (min/max)	6/700
Opgenomen vermogen	kW	1,6,4
Gewicht	kg	13,80
Afmetingen (l x b x h)	mm	330 x 360 x 650
Prijs	€	379,00

Digitale, microprocessor gestuurde batterijlader en- starter voor het laden van alle types (lood, gel, AGM, start-stop) met voltage 6/12/24V. Complete lader en starter voor garages. De 'Safe Start' technologie laat toe om te starten zonder de auto/computer of electronica te beschadigen (ABS, airbag, elektronische injectie). De functie STAND-BY laat toe om de autobatterij los te koppelen zonder de on-board computer te wissen. Overzichtelijke display met waarschuwingslampjes voor controle van het laadproces. PULSE-TRONIC : Elektronisch gestuurde laders/starters voor een nog langere levensduur van de batterijen door o.a. constante proces-controle en optimalisatie, gereduceerde laadtemperatuur, bescherming van boordinstrumenten en laden van (bijna) lege batterijen.



Order nr.	830829034 E	
Orig. nr.	STARTRONIC 530	
Spanning	V	230
Laadspanning	V	6-12/24
Laadstroom	A	40
Startstroom	Max. A cc	400
Referentiecapaciteit	Ah 15h (min/max)	10/600
Opgenomen vermogen	kW	1,5/9,5
Instelposities laadstroom		4
Gewicht	kg	19,50
Afmetingen (l x b x h)	mm	390 x 260 x 230
Prijs	€	819,00

Batterijladers en snelstarters met transformator



NEVADA 11



Compacte batterijlader. Voor het laden van loodbatterijen. Bescherming tegen overload en verkeerde aansluiting. Met ampèremeter en klemmen.

Order nr.		830807023	830807024	830807026
Orig. nr.		NEVADA 11	NEVADA 12	NEVADA 15
Spanning	V	230	230	230
Laadspanning	V	12	12	12/24
Laadstroom	A	2,5	4	6-3A
Opgenomen vermogen	kW	0,05	0,08	0,11
Capaciteit batterij	Ah	90	90	90
Voor loodbatterij		✓	✓	✓
Referentiecapaciteit	Ah (15h min/max)	25/40	40/70	60/115(12V) 30/40(24V)
Gewicht	kg	1,66	1,78	2,63
Afmetingen (l x b x h)	mm	95 x 190 x 180	95 x 190 x 180	95 x 190 x 180
Prijs	€	52,00	55,00	65,00



6/12V



Compacte batterijlader. Met automatische controle van de laadstroom en automatisch stopzetten en hervatten van het laden. Voorzien van waarschuwingslichtjes voor signalisatie van correcte voeding en polariteitsomkering. Speciaal ontworpen voor het laden van GEL batterijen met een spanning van 6V/12V voor motos en scooters. De speciale functie (BYPASS) laat toe om een batterij op te laden die zeer lange tijd niet heeft gewerkt of waarvan de aansluitklemmen bedekt zijn met sulfaat. Functie TRONIC : Elektronisch gestuurde laders/starters. Mogelijkheden o.a.: desulfateren, druppelladen en bescherming tegen verkeerd aansluiten.

Order nr.		830807010
Orig. nr.		MOTOTRONIC 6/12
Spanning	V	230
Laadspanning	V	6-12
Laadstroom	A	3-4
Opgenomen vermogen	kW	0,05
Capaciteit batterij	Ah	20
Voor loodbatterij		✓
Voor gelbatterij		✓
Voor AGM batterij		✓
Referentiecapaciteit	Ah (15h min/max)	4/20(6V) - 6/30(12V)
Gewicht	kg	1,77
Afmetingen (l x b x h)	mm	95 x 190 x 180
Prijs	€	80,00



NEVATRONIC 12

Compacte batterijlader met automatische controle van de laadstroom en automatisch stopzetten en hervatten van het laden waarden. Voorzien van waarschuwingslichtjes voor signalisatie van correcte voeding en polariteitsomkering. Speciaal ontworpen voor het laden van hermetisch afgesloten batterijen (GEL) met een spanning van 12V en/of 24 V. Functie TRONIC : Elektronisch gestuurde laders/starters. Mogelijkheden o.a.: desulfateren, druppelladen en bescherming tegen verkeerd aansluiten.

Order nr.		830807027 ^E	830807045 ^E
Orig. nr.		NEVATRONIC 12	NEVATRONIC 24
Spanning	V	230	230
Laadspanning	V	12	12/24
Laadstroom	A	6	6-4,5
Opgenomen vermogen	kW	0,09	0,11
Voor gelbatterij		✓	✓
Voor AGM batterij		✓	✓
Referentiecapaciteit	Ah (15h min/max)	40/50	40/55 (12V) 30/45 (24V)
Gewicht	kg	2,25	2,55
Afmetingen (l x b x h)	mm	95 x 190 x 180	95 x 190 x 180
Prijs	€	76,00	86,00



12/24V



ALPINE 18

Monofazige batterijlader met BOOST functie. Voor het laden van loodbatterijen met een spanning van 12V/24V. Bescherming tegen overload en verkeerde aansluiting. Metalen behuizing. Schakelaar voor keuze tussen normaal laden en snel laden. Met ampèremeter.

Order nr.		830807545 ^E	830807547 ^E
Orig. nr.		ALPINE 18	ALPINE 30
Spanning	V	230	230
Laadspanning	V	12/24	12/24
Laadstroom	A	9,5	20
Opgenomen vermogen	kW	0,2	0,8
Capaciteit batterij	Ah	120	200
Voor loodbatterij		✓	✓
Referentiecapaciteit	Ah (15h min/max)	14/185(12V)	15/400
Gewicht	kg	3,45	8,60
Afmetingen (l x b x h)	mm	170 x 250 x 165	225 x 290 x 205
Prijs	€	81,00	139,00

Batterijladers



LEADER 150

START



LEADER 220

Monofazige batterijlader met START functie. Voor het laden van loodbatterijen met een spanning van 12V/24V en het starten van benzinemotoren (Leader150-220) en dieselmotoren (Leader 400). Bescherming tegen overload en positieve aansluiting. Snel laden. Met ampèremeter.

Order nr.		830807549 ^E	830807550 ^E	830807551 ^E
Orig. nr.		LEADER 150	LEADER 220	LEADER 400
Spanning	V	230	230	230
Laadspanning	V	12	12/24	12/24
Laadstroom	A	14	20	45
Opgenomen vermogen	kW	0,3/1,4	0,8/3,6	1/6,4
Starter		✓	✓	#0#
Capaciteit koude batterij	Ah	20	60	90
Capaciteit batterij na voorverwarming	Ah	60	100	120
Startstroom	Max. A cc	140	180	300
Voor loodbatterij		✓	✓	✓
Referentiecapaciteit	Ah (15h min/max)	25/250	30/400	20/700
Gewicht	kg	6,60	9,40	10,85
Afmetingen (l x b x h)	mm	225 x 290 x 205	225 x 290 x 205	265 x 345 x 230
Prijs	€	124,00	162,00	209,00



Monofazige batterijlader met automatische controle van de oplaadstroom voor lood- en gelbatterijen met een spanning van 12/24V. Keuze tussen normaal laden, snel laden (BOOST), buffermodus en druppelladen. Het automatisch opladen is geschikt voor hermetische batterijen (GEL) en het druppelladen voor traditionele batterijen met accuvloeistof. Bescherming tegen overbelasting en omkeren van de polariteit. Met ampèremeter. Functie TRONIC : Elektronisch gestuurde laders/starters. Mogelijkheden o.a.: desulfateren, druppelladen en bescherming tegen verkeerd aansluiten.

Order nr.		830807540 ^E
Orig. nr.		AUTOTRONIC 25 BOOST
Spanning	V	230
Laadspanning	V	12/24
Laadstroom	A	18-12
Opgenomen vermogen	kW	0,3
Voor loodbatterij		✓
Voor gelbatterij		✓
Voor AGM batterij		✓
Referentiecapaciteit	Ah (15h min/max)	30/225(12V) - 20/180(24V)
Gewicht	kg	7,20
Afmetingen (l x b x h)	mm	225 x 290 x 205
Prijs	€	149,00



Professionele, draagbare, batterijlader voor de garage. Voor het laden van alle types van loodbatterijen met een spanning van 6/12/24/36/48V. Laat het gelijktijdig laden toe van meerdere batterijen in serie. Uitgerust met ampèremeter en voltmeter.

Order nr.		830807063 €
Orig. nr.		COMPUTER48/2
Spanning	V	230
Laadspanning	V	6-1224-36-48
Laadstroom	A	11-30-30-30-27
Conventionele stroom EN 60335-229	A	7-20-20-20-18
Referentiecapaciteit	Ah 15h (min/max)	10/100-300-300-300-300
Opgenomen vermogen	kW	1
Instelposities laadstroom		6
Voor loodbatterij		✓
Gewicht	kg	12,70
Afmetingen (l x b x h)	mm	280 x 350 x 320
Prijs	€	369,00



DYNAMIC 420

CHARGE & START



DYNAMIC 520



DYNAMIC 620



Batterijlader - starter op wielen, voor het laden van loodbatterijen met een voltage van 12/24V en voor het starten van alle types van auto's, bestelwagens, lichte vrachtwagens, tractoren en vrachtwagens. Werkt op het lichtnet, en niet met batterij. Bescherming tegen overload en positieve aansluiting. Keuze uit normaal laden, snel laden en snel starten. Timer (type 520 en 620) weergave van de laadstroom en de startstroom via ampèremeter.

Order nr.		830829382 €	830829383 €	830829384 €
Orig. nr.		DYNAMIC 420	DYNAMIC 520	DYNAMIC 620
Spanning	V	230	230	230
Laadspanning	V	1224	1224	1224
Laadstroom	A	50	75	70
Opgenomen vermogen	kW	1,6/10	1,6/10	2/10
Starter		✓	✓	✓
Startstroom	Max. A cc	400	400	570
Referentiecapaciteit	Ah (15h min/max)	20/1000	20/1000	20/1550
Gewicht	kg	16,90	20,30	23,80
Afmetingen (l x b x h)	mm	330 x 360 x 650	320 x 480 x 735	320 x 480 x 735
Prijs	€	284,00	379,00	399,00



Telwin starters-boosters



SPEED START 1812



Draagbare startbooster met batterij, voor het starten met 12V van auto's, bestelwagens, boten, kleine landbouwmachines. Hij onderhoudt de spanning op alle circuits gedurende het vervangen van de batterij; 12V krachtbron voor in noodgevallen. Beschadigt de elektronica van het voertuig niet. Herladen met 220V netwerk adapter, of met 12Vaanstekeringuitgang. Met kabels, tangen en 3,6W lamp. Om de perfecte werking van de batterij te behouden, opnieuw opladen gedurende 12 uur voor en na ieder gebruik en iedere 3 maanden. Geschikt voor alle types batterijen.

Order nr.	830829512 €	
Orig. nr.	SPEED START 1812	
Capaciteit batterij	Ah	38
Capaciteit koude batterij	Ah	120
Spanning	V	230
Laadspanning	V	12
Startstroom	Max. A cc	1500
Startcapaciteit	Ah	120
Uitgangsstroom	A	600
Gewicht	kg	14,60
Afmetingen (l x b x h)	mm	200 x 320 x 350
Prijs	€	194,00



- alarm signaal
- LED licht
- 12V stekker



PRO START 2824



PRO START 2212

Draagbare startbooster met batterij, voor het starten met 12V (2212) of 12/24V (2824) van auto's, bestelwagens, boten, kleine landbouwmachines. Wanneer geconnecteerd aan de aansteker in de wagen, onderhouden ze spanning op alle circuits gedurende het vervangen van de batterij; 12V krachtbron voor in noodgevallen. Beschadigen de elektronica van het voertuig niet. Herladen met 220V netwerk adapter, of met aanstekeringuitgang van. Met kabels, tangen en 3,6W lamp.

Om de perfecte werking van de batterij te behouden, opnieuw opladen gedurende 12 uur voor en na ieder gebruik en iedere 3 maanden. Met geluidsalarm tegen omgekeerde polariteit, LED-lamp die de staat van de batterij aangeeft en 2 x 12V stekkers.

Order nr.	830829516 €		830829517 €	
Orig. nr.	PRO START 2212		PRO START 2824	
Capaciteit batterij	Ah	34	44-22	
Spanning	V	230	230	
Laadspanning	V	12	12-24	
Startstroom	Max. A cc	1800	2500	
Capaciteit koude batterij	Ah	150	150-100	
Uitgangsstroom	A	550	800	
Gewicht	kg	14,60	16,10	
Afmetingen (l x b x h)	mm	205 x 335 x 360	205 x 335 x 360	
Prijs	€	229,00	279,00	



Professionele, krachtige starter-booster met batterij, voor het starten van voertuigen op 24V en 12V. Werkt op basis van een batterij en is dus autonoom. 12V krachtbron voor in noodgevallen. Beschadigen de elektronica van het voertuig niet. Herladen met 220V netwerk adapter, of met T-CHARGE 12 (inbegrepen bij model 4824). Met startkabels en tangen geleverd. Om de perfecte werking van de batterij te behouden, opnieuw opladen gedurende 12 uur voor en na ieder gebruik en iedere 3 maanden.

Order nr.		830829558 €	830829560 €
Orig. nr.		STARTPLUS 4824	STARTPLUS 6824
Capaciteit batterij	Ah	100(12V) - 50(24V)	130(12V) - 65(24V)
Capaciteit koude batterij	Ah	120	180
Spanning	V	230	230
Laadspanning	V	12-24	12-24
Startstroom	Max. A cc	4400(12V) - 2200(24V)	6000(12V) - 3000(24V)
Uitgangsstroom	A	1600(12V) - 800(24V)	2000(12V) - 1000(24V)
Lengte kabel	m	2	3
Gewicht	kg	55,40	55,40
Afmetingen (l x b x h)	mm	305 x 360 x 630	450 x 460 x 760
Prijs	€	729,00	1.199,00

Accessoires

Set zekeringen. VE = verpakkingseenheid.

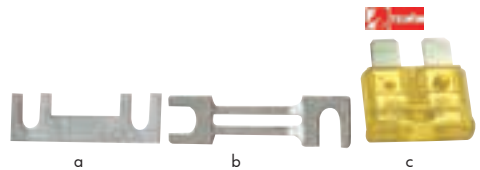

Order nr.	Orig. nr.	Voor type	Ampère	Afbeelding	Lengte	VE	Prijs/VE
			A		mm		€
830802258 €	802258	Computer 48/2 - Leader 150,220 - Dynamic 220 - Digitrony 230	30	a	-	20	8,30
830802029 €	802029	Dynamic 620	100	a	-	20	10,00
830802260 €	802260	Dynamic 420 - Dynamic 520	80	a	-	20	8,30
830802131 €	802131	Energy 650	100	b	100	10	16,00
830802257 €	802257	-	20	b	-	10	3,00
830802129 €	802129	Energy 1000	300	b	120	10	32,00
830802319 €	802319	Nevada 5 - Nevada 6	4	c	-	10	6,00
830802265 €	802265	Nevada 10 - Nevada 11 - Nevada 12 - Alpine 13	7,5	c	-	10	3,00
830802255 €	802255	Mototronic 6/12 - Nevada 15	10	c	-	10	3,00
830802256 €	802256	Nevatronic 12 - Nevatronic 24 - Alpine 18 - Alpine 30	15	c	-	10	3,00
830802114 €	802114	Autotronic 25	30	c	-	10	6,00
830802259 €	802259	Alpine 50 - Leader 400 - Digistart 340 - Dynamic 3000	50	a	-	10	8,30
830122438 €	122438	Oud model - Lengte 6 cm	80	b	60	10	2,20
830121003 €	121003	Oud model - Lengte 3 cm	100	b	30	10	1,00
830122452 €	122452	Oud model - Lengte 8 cm	100	b	80	10	2,25



Set startkabels. Lengte 3m. 16mm² (voor personen- en bestelwagens) of 25 mm² (voor vrachtwagens).

Order nr.	830802515	830802516
Orig. nr.	802515	802516
Capaciteit	mm ² /A 16/220	25/350
Prijs	€ 51,00	84,00

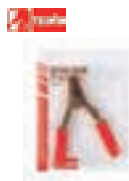

Aansluitklemmen batterijladers.

Order nr.	Orig. nr.	Omschrijving	Prijs €
830802527	802527	Rood 40 A	4,00
830802528	802528	Zwart 40 A	4,39
830802529	802529	Rood 60 A	4,80
830802530	802530	Zwart 60 A	4,80
830802531	802531	Rood 150 A	4,00
830802532	802532	Zwart 150 A	4,20

Testers



Batterijtester. Controleert elke pool van de batterij apart. Met grote display 6 - 12V. Met weerstand die effectieve capaciteit test onder belasting.

Order nr.	830802517
Orig. nr.	802517
Spanning	V 6-12
Capaciteit	Ah 20-200
Gewicht	kg 0,48
Prijs	€ 60,00



Digitale batterijtester. 12V. Test alle soorten batterijen : WET/ GEL/AGM/MF. Met start test 110-1440 A en ladingstest.

Order nr.	830802605
Orig. nr.	802605
Spanning	V 12
Capaciteit	Ah 20-200
Testfuncties	2
Gewicht	kg 0,18
Prijs	€ 74,00



Digitale batterijtester. 12V. Test alle soorten batterijen : WET/ GEL/AGM/MF. Met start test 110-1440 A, ladingstest, alternator circuittest en startstysteemtest. Gebruiksvriendelijk LCD-Display.

Order nr.	830802665
Orig. nr.	802665
Spanning	V 12
Capaciteit	Ah 20-200
Testfuncties	4
Gewicht	kg 2,00
Prijs	€ 112,00



NEW

Controleert direct de lading van uw autobatterij of van uw snelstarter, via de sigarettenaansteker.

Order nr.	830802695
Orig. nr.	JUMP START CHECK
Testspanning	V 12/24
Prijs	€ 16,00



Interfacekabel tussen Telwin PROSTART boosters en OBD II poort van uw voertuig. Door de stroomvoorziening wordt het geheugen van uw boordcomputer niet gewist bij loskoppelen van de autobatterij. Universeel bruikbaar.

Order nr.	830802693 ^E
Orig. nr.	802693
Prijs	€ 19,00

Stroomomvormers



Stroomomvormer van 12V naar 230V AC. Ideaal voor stroomvoorziening in de wagen en kampeerwagen voor draagbare TV, scheermachine, smartphone, laptop, camera, ... Compleet met aansluiting voor sigarettenaansteker. Draagbaar en compact. Beschermd tegen polariteitsomkeer en overbelasting.

Order nr.	830829440	830829446	830829447
Orig. nr.	CONV70	CONV500	CONV1000
Ingangsspanning	V 12	V 12	V 12
Uitgangsspanning	V 230	V 230	V 230
Uitgangsfrequentie	Hz 50	Hz 50	Hz 50
Maximum vermogen	W 70	W 500	W 1000
Gewicht	kg 0,22	kg 1,90	kg 2,80
Afmetingen (l x b x h)	mm 115 x 60 x 35	mm 232 x 130 x 71	mm 337 x 130 x 71
Prijs	€ 48,00	€ 127,00	€ 229,00



■ 2 x USB poort

Stroomomvormer van 12V naar 230V wisselspanning AC. Ideaal voor stroomvoorziening in de wagen: smartphones, laptop, camera, ... met 2x USB uitgang en 1x 230V AC uitgang. Compleet met aansluiting voor sigarettenaansteker. Draagbaar en compact. Beschermd tegen polariteitsomkeer en overbelasting.

Order nr.	830829444	
Orig. nr.	USB CONVERTER 310	
Ingangsspanning	V	12
Uitgangsspanning	V	230
Uitgangsfrequentie	Hz	50
Maximum vermogen	W	300
Gewicht	kg	0,50
Afmetingen (l x b x h)	mm	172 x 85 x 52
Prijs	€	62,00



Metalworks starters-boosters

METALWORKS



Dragbare startboosters op batterij, voor het starten op 12 of 12/24V van auto's, bestelwagens, ... Start voertuigen zonder netstroom langs de snelweg, in de garage, ... Metalen behuizing met handvat en krasvrij anti-slip bodemstuk. Eenvoudig bedieningspaneel met batterijtest en led-indicator. Herladen met 220V netwerkadapter. Geleverd met kabels en tangen. Om de perfecte werking van de batterij te behouden: op laden voor en na ieder gebruik en iedere 3 maanden. Geschikt voor alle types batterijen.

Order nr.		829000110 €	829000120 €
Orig. nr.		DUAL START 3412	DUAL START 3424
Capaciteit batterij	Ah	2x22	90
Spanning	V	230	230
Laadspanning	V	12	12/24
Startstroom	Max. A cc	2400	2400(12V) en 1200(24V)
Capaciteit koude batterij	Ah	90	2x22
Gewicht	kg	15,00	15,00
Afmetingen (l x b x h)	mm	287 x 218 x 336	287 x 218 x 336
Prijs	€	214,00	294,00

METALWORKS



NOVA15

NEW



NOVA30

NIUW

Dragbare batterijlader met transformator voor het opladen van loodaccu's in auto's en bestelwagens. Voor batterijspanning 12 en 24V. Met functies normaal en snel laden (boost) en met thermische beveiliging tegen overladen en tegen polariteitswissel. Snel verwisselbare zekeringen op het frontale bedieningsbord. Uitergerust met ampèremeter, draagbeugel en opbergvak voor kabels. CE conform.

Order nr.		829000175 €	829000178 €
Orig. nr.		NOVA 15	NOVA30
Spanning	V	230	230
Laadspanning	V	12/24	12/24
Laadstroom	A	6-4	20
Opgenomen vermogen	kW	0,15	0,7
Referentiecapaciteit	W	25/105	
Gewicht	kg	5,20	9,50
Afmetingen (l x b x h)	mm	260 x 230 x 197	285 x 230 x 210
Prijs	€	54,00	79,00

	12-24V	20Ah	60Ah	80Ah	100Ah	150Ah	250Ah
CHARGE	NOVA 15	[Bar chart showing charging capacity]					
	NOVA 30	[Bar chart showing charging capacity]					
START CHARGE	NOVA 50S	[Bar chart showing charging capacity]					
	NOVA 400S				START		
	NOVA 600S				START		
START	DUAL START 3412				START		
	DUAL START 3424				(12V)		

NEW



NOVA50S

Draagbare batterijlader-starter met transformator voor het opladen van loodaccu's en het snelstarten van auto's en bestelwagens. Voor batterijspanning 12 en 24V. Met functies normaal en snel laden (boost), en snelstarten (START). Met thermische beveiliging tegen overladen en tegen polariteitswissel. Snel verwisselbare zekeringen op het frontale bedieningsbord. Uitgerust met ampèremeter, draagbeugel en opbergvak voor kabels. CE conform.

Order nr.	829000182 E	
Orig. nr.	NOVA 50S	
Spanning	V	230
Laadspanning	V	12/24
Startstroom	Max. A cc	180
Startcapaciteit	Ah	20
Laadstroom	A	40
Referentiecapaciteit	Ah (15h min/max)	40-700
Referentiecapaciteit	W	40/700
Opgenomen vermogen	kW	laden 1.2 start 7
Gewicht	kg	14,50
Afmetingen (l x b x h)	mm	325 x 310 x 215
Prijs	€	110,00



NOVA400S



NOVA600S

Mobiele batterijlader-starter met transformator voor het opladen van loodaccu's en het snelstarten van auto's, bestelwagens, vrachtwagens,... met batterijspanning 12 en 24V. Met functies normaal en snel laden (boost), en snelstarten (START). Met thermische beveiliging tegen overladen en tegen polariteitswissel. Snel verwisselbare zekeringen op het frontale bedieningsbord. Uitgerust met kabels, klemmen, ampèremeter, draagbeugel; wielen en opbergvak voor kabels. CE conform.

NOVA600S met timerfunctie.

Order nr.	829000190 E	829000192 E
Orig. nr.	NOVA400S	NOVA600S
Spanning	V	230
Laadspanning	V	12/24
Startcapaciteit	Ah	50
Laadstroom	A	40
Referentiecapaciteit	W	40/700
Opgenomen vermogen	kW	laden 1.6 start 8
Prijs	€	155,00
		240,00

PROTEMP



PROTEMP HEATS YOUR WORKSHOP





Elektrische modellen met stralingswarmte



MO767C standaard

INSTANT HEAT



2 x MO767C op voet met voetadaptor



MO767C op voet met voetadaptor



MO766C met muuradaptor



BEKIJK DE VIDEO



Infrarood heaters met aangename warmtestraling. Door de gerichte reflectie van de warmte, gaat er minder energie verloren dan bij traditionele verwarmingstoestellen. Infrarood-straling verwarmt personen en objecten direct, zonder de omgevende atmosfeer te beïnvloeden: een direct en krachtig resultaat, zelfs bij wind. Tot slot produceren deze heaters geen uitlaatgassen, zodat ze bijzonder geschikt zijn voor indoor werkomgevingen. Geen behoefte aan ventilatie. De hoogwaardige infraroodlampen hebben een gemiddelde levensduur van 5000 uren. Modellen met 1200 of 1760Watt.

- Geschikt voor binnen- en buitentoepassingen of bij regenval.
- Water- en stofbestendig (IP65).
- Verstevigde stroomkabel voor toepassing op werven of in constructie-omgevingen (H07RNF).
- Geleverd met ketting voor plafondophanging. Voet en muurbevestiging optioneel.

MO767SET bestaat uit 2 lampen type MO767C samen met een stabiele voet en voetadapter. Hiermee verwarmt u een grotere werkplaats, zonder een extra hinderende voet te plaatsen.

Order nr.	722316345 E	722316350 E	722316352 E
Orig. nr.	MO766C	MO767C	MO767SET
Warmte type	IR-A	IR-A	IR-A
Energiebron	elektriciteit	elektriciteit	elektriciteit
Totaal verbruik	W	1200	1760
Verwarmbare ruimte	m ³	4-6	8-10
Spanning	V	230	230
Type lampen		wit	wit
Levensduur	u	5000	5000
Kabel	H07RN-F	H07RN-F	H07RN-F
Isolatieklasse		I	I
Beschermingsklasse	IP	65	65
Geschikt voor buitengebruik		✓	✓
Stralingsfrequentie		korte golf	korte golf
Gewicht	kg	0,95	1,00
Afmetingen (l x b x h)	mm	712 x 112 x 83	835 x 112 x 83
Prijs	€	123,00	139,00
			339,00



4000W

Infrarood straler met krachtige 4000W output. Door de gerichte reflectie van de warmte, gaat er minder energie verloren dan bij traditionele verwarmingstoestellen. Infrarood-straling verwarmt personen en objecten direct, zonder de omgevende atmosfeer te beïnvloeden: een direct en krachtig resultaat, zelfs bij wind. Tot slot produceren deze heaters geen uitlaatgassen, zodat ze bijzonder geschikt zijn voor werkomgevingen. De hoogwaardige infraroodlampen hebben een gemiddelde levensduur van 5000 uren. Industriële elektrische infraroodheater met goudgele lamp 4000Watt. Gerichte hittestaling. Aluminium behuizing, geschikt voor binnentoepassingen zoals productielijnen of drooginstallaties in de carrosserie. Geschikt voor muur- en plafondophanging. Zonder kabel en stroomstekker.

Order nr.	722316360	
Orig. nr.	MO792	
Warmte type	IR-A	
Energiebron	elektriciteit	
Totaal verbruik	W	4000
Verwarmbare ruimte	m ³	12-16
Spanning	V	230/3x400
Type lampen	goud	
Levensduur	u	5000
Kabel	x	
Stralingsfrequentie	korte golf	
Muurbevestiging	✓	
Gewicht	kg	2,40
Afmetingen (l x b x h)	mm	235 x 486 x 313
Prijs	€	329,00



muuradapter voor MO767C



768P (voetadapter voor MO767C)



voet voor MO 767C

Accessoires voor de montage op muur of sokkel van MOEL heaters.

Order nr.	722316365	722316367	722316366
Orig. nr.	768M	768P	002473
Omschrijving	muuradapter	voetadapter	voet
Voor type	MO766C/MO767C	MO766C/MO767C	MO766C/MO767C
Gewicht	kg	0,50	10,00
Prijs	€	13,00	54,00

Elektrische modellen met geventileerde warmte

PRIMOFLUOR



PT033-230

VENTILEREN+VERWARMEN

Elektrische warmeluchtblazer.

- Geschikt voor het verwarmen van werkplaatsen, werven, ...
- Verbruikt geen zuurstof en geeft geen vocht of geur af.
- Meerstanden-schakelaar voor ventilator, en thermostaat.
- Thermisch beveiligd en geluidsarm
- Geleverd met kabel en stekker.
- Aansluiting op 230V
- Beveiligingsklasse IPX4, CE gekeurd.

Order nr.		722316200 €	722316205 €
Orig. nr.		PT02-230	PT033-230
Afgegeven warmte	kW/h	2	3
Verwarmbare ruimte	m ³	15-20	20-30
Spanning	V	230	230
Thermostaat		✓	✓
Frequentie	Hz	50	50
Gewicht	kg	4,80	5,60
Afmetingen (l x b x h)	mm	237 x 250 x 355	300 x 300 x 450
Prijs	€	51,50	74,90

STABILEY



Elektrische verwarmingstoestellen met ventilator.

- geschikt voor het verwarmen van kleine werkplaatsen of kantoren
- verbruikt geen zuurstof en geeft geen vocht of geur af
- meerstanden-schakelaar voor ventilator, en thermostaat
- thermisch beveiligd en geluidsarm
- beveiligingsklasse IPX4, CE gekeurd.

Order nr.		722316216 €
Orig. nr.		ST09-400
Afgegeven warmte	kW/h	9
Verwarmbare ruimte	m ³	60-90
Spanning	V	3x400
Thermostaat		✓
Gewicht	kg	10,30
Afmetingen (l x b x h)	mm	465 x 400 x 540
Prijs	€	164,00

STRALINGSWARMTE VS GEVENTILEERDE WARMTE

In tegenstelling tot infraroodverwarming zijn de meeste verwarmingskanalen, zoals ook een radiator, primair gebaseerd op convectie. Een groot nadeel van convectie is dat er een luchtstroom optreedt. De ruimte wordt dan onevenwichtig verwarmd.

Geventileerde warmte (= convectie warmte)

1. Warmeluchtstroom
2. Warme lucht stijgt, koude lucht daalt: koudevoeteneffect
3. Geen constante relatieve vochtigheid, condensatievocht op ramen en deuren
4. Vrij hoog energieverlies door ventilatie
5. Groei van huisstofmijt wordt gestimuleerd

Stralingswarmte (= infraroodwarmte)

1. Geen luchtstroom: personen en objecten worden direct opgewarmd
2. Geen koudevoeteneffect
3. Constante relatieve vochtigheid, geen condensatie
4. Lage ventilatieverliezen

Dieselmodellen met geventileerde warmte



PT70T-KFA-EU



PT125T-KFA-EU



PT215T-KFA-EU

MET THERMOSTAAT

VOOR GROTE RIJMTES

Warmeluchtblazers met ventilator voor grote hallen en werkplaatsen.

- Brandstof: diesel en witte petroleum.
- Directe verbranding.
- Zowel binnen als buiten perfect inzetbaar voor het verwarmen, drogen en ontdooien van geventileerde ruimtes; ideaal voor gebruik op bouwerven.
- Zeer mobiel dankzij 2 stevige rubber wielen (behalve PT70T-KFA-EU) met draagbeugel.
- Met thermostaatbediening.
- Aan/af schakelaar.
- Met drukmeter en digitale thermometer.
- Ingebouwde tank met brandstofniveaumeter.
- CE gekeurd.

Order nr.		722314070 €	722314125 €	722314175 €	722314215 €
Orig. nr.		PT 70T-KFA-EU	PT 125T-KFA-EU	PT-175KFAE	PT 215T-KFA-EU
Afgegeven warmte	kW/h	20.496	36.600	51.250	62.994
Warmte type		geventileerde lucht	geventileerde lucht	geventileerde lucht	geventileerde lucht
Energiebron		petroleum/diesel	petroleum/diesel	petroleum/diesel	petroleum/diesel
Thermostaat		✓	✓	✓	✓
Capaciteit brandstoftank	l	19	38	49	49
Brandstofverbruik	l/u	2	3,60	5,10	6,17
Verwarmbaar volume	m ³	158	288	399	492
Spanning	V	230	230	230	230
Autonomie	u	9	10	9,5	8
Frequentie	Hz	50	50	50	50
Gewicht	kg	12,70	23,00	26,30	27,70
Afmetingen (l x b x h)	mm	356 x 432 x 812	457 x 510 x 965	457 x 510 x 1092	457 x 510 x 1092
Prijs	€	339,00	505,00	539,00	579,00

Dieselmodellen met stralingswarmte

PROFIBER



PT70-SS-EU



PT-125-OFRE-EU

Infrarood - warmeluchtblazer met een comfortabele stralingswarmte. De gepatenteerde infraroodverbranding garandeert een totale en reukarme verbranding. Beperkte stofafzetting en een zeer geruisloze werking.

- Brandstof: diesel en witte petroleum.
- Zowel binnen als buiten perfect inzetbaar voor het verwarmen, drogen en ontdooien van geventileerde ruimtes; ideaal voor gebruik op bouwerven.
- Type PT70-SS-EU is eenvoudig verplaatsbaar dankzij zijn laag gewicht en handvat, type PT125-OFRE-EU is mobiel dankzij 2 stevige rubber wielen.
- Bescherming tegen oververhitting dankzij de ingebouwde fotocelvlambewaking.
- Roestvrijstalen behuizing van de stralingskamer en -elementen.
- Ingebouwde tank met brandstofniveaumeter -aan/af schakelaar, met thermostaat.
- Veiligheden: vlambewaking, oververhittingssensor en hoeksensor zorgen voor optimale veiligheid.
- CE gekeurd.

Order nr.		722315070	722315125
Orig. nr.		PT-70-SS-EU	PT-125-OFRE-EU
Afgegeven warmte	kW/h	20,509	36,600
Warmte type		stralingswarmte	stralingswarmte
Energiebron		petroleum/diesel	petroleum/diesel
Capaciteit brandstoftank	l	13,2	47,3
Brandstofverbruik	l/u	1,4	2,6/3,6
Autonomie	u	7	17/13
Verwarmbare ruimte	m ²	163	290
Thermostaat		✓	x
Spanning	V	230	230
Gewicht	kg	13,40	44,00
Afmetingen (l x b x h)	mm	530 x 550 x 370	721 x 706 x 980
Prijs	€	479,00	1.279,00



Gasmodellen met geventileerde warmte



PT50V-GFA-E



PT150V-GFA-E

Warmeluchtblazers op propaan gas uitgerust met een ingebouwde elektrische ventilator.

- Zowel binnen als buiten perfect inzetbaar voor het verwarmen, drogen en ontdooien van geventileerde ruimtes; ideaal voor gebruik op bouwerven (Bij binnengebruik, is goede ventilatie aangewezen).
- Geleverd met POL of SHELL ontspanner voor gasflessen met binnendraad of buitendraad.
- Eenvoudig verplaatsbaar.
- Draaiknop met 3 temperaturniveaus, niet thermostatisch.
- Bescherming tegen oververhitting.
- Elektronische ontsteking van de vlam.
- Beveiliging schakelt gas uit in geval van stroompanne.
- Geleverd met gas slang.
- CE gekeurd.



SHELL ontspanner



GFA POL ontspanner



Order nr.		722316050 €	722316053 €	722316150 €	722316153 €
Orig. nr.		PT 50V-GFA-E POL	PT 50V-GFA-E SH	PT 150V-GFA-E POL	PT 150V-GFA-E SH
Afgegeven warmte	kW/h	14,649	14,649	43,950	43,950
Warmte type		geventileerde lucht	geventileerde lucht	geventileerde lucht	geventileerde lucht
Energiebron		propaan gas	propaan gas	propaan gas	propaan gas
Brandstofverbruik	l/u	1	1	3	3
Verwarmbare ruimte	m²	115	115	345	345
Spanning	V	230	230	230	230
Aansluiting ontspanner		POL	SHELL	POL	SHELL
Frequentie	Hz	50	50	50	50
Gewicht	kg	11,20	11,20	8,00	8,00
Afmetingen (l x b x h)	mm	462 x 198 x 345	462 x 198 x 345	637 x 226 x 403	637 x 226 x 403
Prijs	€	154,00	154,00	229,00	229,00



Ventilatoren

METALWORKS



Mobiele ventilator voor drogen, verluchten, afkoelen, toevoeren of afvoeren van lucht. Samen met de optionele slangen en/of filterzak bruikbaar voor het verwijderen van rook, lasrook, gassen, geuren, slijpstof, of toevoeren van verse lucht in zuurstofarme werkruimtes zoals kelders, schepen, containers. Filterzak geschikt voor verwijderen van kwartsstof op werven.

Hoog debiet en laag geluidsniveau.
Dubbel afschermrooster en thermische beveiliging.

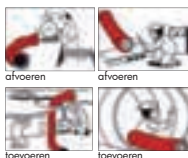

COMPACTE BOUWVENTILATOR

Order nr.	722313500 ^E	
Orig. nr.		MV300
Vermogen	W	500
Totale druk	pa	385
Isolatiegraad		F
Diameter	mm	300
Spanning	V	230
Debiet	m ³ /min	65
Snelheid	tpm	2800
Werktemperatuur	°C	-20 - +80
Geluidsniveau	dB(A)	69
Gewicht	kg	17,00
Afmetingen (l x b x h)	mm	380 x 375 x 360
Prijs	€	109,00

METALWORKS

Mobiele ventilatoren op wielen voor drogen, verluchten, afkoelen, toevoeren of afvoeren. Samen met de optionele toe- of afvoerslang inzetbaar voor het verwijderen van rook, lasrook, gassen, geuren, slijpstof, of toevoeren van verse lucht in zuurstofarme werkruimtes zoals kelders, schepen, containers.

Zeer hoog debiet en laag geluidsniveau. Dubbel afschermrooster en thermische beveiliging. De blaashoek is instelbaar op het mobiele frame. Geleverd op wielen voor vlotte verplaatsing.

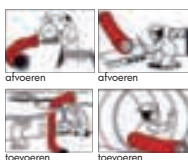

TOEVOEREN EN AFVOEREN



MV500R

Order nr.	722313505 ^E		722313510 ^E	
Orig. nr.		MV500R		MV600R
Vermogen	W	1100		2000
Totale druk	pa	400		480
Isolatiegraad		F		F
Diameter	mm	500		600
Spanning	V	230		230
Debiet	m ³ /min	130		240
Snelheid	tpm	1400		1400
Werktemperatuur	°C	-20 - +80		-20 - +80
Geluidsniveau	dB(A)	72		77
Gewicht	kg	27,00		67,00
Afmetingen (l x b x h)	mm	480 x 580 x 755		580 x 680 x 870
Prijs	€	284,00		459,00

Een goede ventilatie is de basis voor een gezonde werkomgeving. Stof, rook, dampen of gevaarlijke gassen (CO) kunnen best worden afgevoerd met een ventilator met afvoerslang. Ventilatoren kunnen ook de toevoer van verse lucht in kelders of containers voorzien, indien daar een problematisch gebrek aan is. Tenslotte behoort ook drogen en koelen van machines of mensen tot de mogelijkheden. In warme bedrijfsgebouwen of op evenementen mogen de grote axiaalventilatoren of windmakers dus niet ontbreken. Ook kan er met de vaste ventilatoren kan 's nachts frisse lucht naar binnen worden gebracht.

METALWORKS



Toe- of afvoerslang 10m voor mobiele ventilatoren. Flexibel en onbrandbaar nylon, ook geschikt bij slijp- of laswerken. Meerdere slangen kunnen na elkaar gekoppeld worden.

Order nr.	722313501 E	722313506 E	722313511 E
Orig. nr.	MV300SL	MV500SL	MV600SL
Diameter	mm 300	500	600
Werktemperatuur	°C -30 - +80	-30 - +80	-30 - +80
Lengte	m 10	10	10
Voor type	°C MV300	MV500R	MV600R
Gewicht	kg 5,00	10,00	20,00
Prijs	€ 79,00	129,00	149,00

METALWORKS



Filterzak voor gebruik op mobiele ventilatoren type MV300. Ideaal voor bouwtoepassingen. Deze filterzak vangt alle schadelijke stofdeeltjes zoals kwarts- en pleisterstof tijdens slijp- en afbraakwerken. Door de grote filteroppervlakte blijft het hoge afzuigebied van de ventilator behouden.

Order nr.	722313502 E
Orig. nr.	MV300FZ
Diameter	mm 300
Lengte	m 3
Filtercategorie	F8
Efficiëntie	% 90-95 (EN779 0.3µm)
Gewicht	kg 3,00
Prijs	€ 24,90



Stof- & waterzuigers



inclusief accessoires



SELF CLEANING FILTER



automatisch stopcontact 230V
max. 1350W

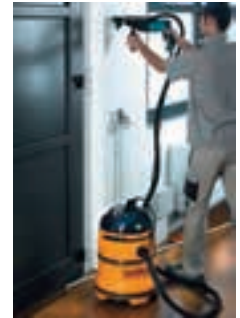

Stofzuiger voor natte en droge toepassingen en voor gebruik met houtbewerkingsmachines. Voorzien van een elektrisch stopcontact. Automatische opstart van de stofzuiger samen met aangesloten machine. Na de beëindiging van de werkcyclus, zorgt de 'Self Cleaning Filter' ervoor dat de filter nog een 10 seconden wordt uitgetrild voor een perfecte reiniging van de filter. Functie ook manueel beschikbaar. Performant bypass systeem. Schokbestendige polypropyleen tank. Ruime set accessoires inbegrepen.

Order nr.		845002000 €
Orig. nr.		PC35 TOOLS EVO
Spanning	V	230
Vermogen motor	kW	1,1
Koeling		bypass
Tankinhoud	l	35
Zuigkracht	mBar	220
Luchtverplaatsing	l/s	50,00
Lengte slang	m	1,8/2,5
Diameter slang	mm	45/25
Geluidsniveau	dB(A)	65
Stopcontacten maximum vermogen	W	1350
Gewicht	kg	11,00
Prijs	€	389,00



gisowatt[®]
S.P.A.
volledig assortiment op vynckier.biz





TELWIN®

Products for 360° Prodotti per soluzioni a



Telwin is present on all 5 continents, in 120 markets, with a strongly rooted, capillary distribution network guaranteeing a reliable, professional service without equal. **Telwin means speed, punctuality, efficiency:** offering its customers an absolute guarantee. **Telwin means advice, assistance and information** through the **Telwin Training Lab**: the protagonist par excellence for all training activities. **Telwin has the widest, most complete range on the market.**



Telwin è una presenza su tutti i 5 continenti, in oltre 120 mercati, una rete distributiva radicata in modo capillare che assicura un servizio inimitabile, affidabile e professionale. **Telwin è rapidità, puntualità, efficienza,** un'assoluta garanzia per i propri clienti. **Telwin è consulenza, assistenza, informazione,** con il **Telwin Training Lab** protagonista eccellente di tutte le attività formative.



Telwin è la gamma più ampia e completa del mercato.

Telwin est présent sur les 5 continents et sur plus de 120 marchés avec un réseau de distribution organisé de façon capillaire offrant un service incomparable, fiable et professionnel. **Telwin est synonyme de rapidité, ponctualité et efficacité,** une garantie absolue pour ses clients. **Telwin est synonyme de conseil, assistance et information** grâce au **Telwin Training Lab** acteur d'excellence de toutes les activités de formation. **Telwin offre la gamme la plus vaste et la plus complète du marché.**



Telwin es una presencia en los 5 continentes, en más de 120 mercados, una red de distribución presente de manera capilar que asegura un servicio inimitable, fiable y profesional. **Telwin es rapidez, puntualidad, eficiencia,** una absoluta garantía para sus clientes. **Telwin es asesoría, asistencia, información,** con el **Telwin Training Lab** protagonista excelente de todas las actividades de formación. **Telwin es la gama más amplia y completa del mercado.**



Telwin ist eine feste Größe auf allen 5 Kontinenten, in mehr als 120 Ländermärkten, mit einem Vertriebsnetz, das kapillarartig verwurzelt ist und einen unnachahmlichen, zuverlässigen und professionellen Service sicherstellt. **Telwin ist Schnelligkeit, Pünktlichkeit und Effizienz,** eine absolute Gewähr für den Kunden. **Telwin ist Beratung, Unterstützung, Information** - dank des **Telwin Training Lab**, dem herausragenden Protagonisten sämtlicher Schulungsaktivitäten. **Telwin ist das reichhaltigste und lückenloseste Angebot auf dem Markt.**



Telwin представлен на 5 континентах более чем в 120 странах мира. Организованная дистрибуторская сеть обеспечивает надежное и профессиональное обслуживание. **TELWIN** - это динамичность, пунктуальность и эффективность. **Telwin** предоставляет обслуживание, консультации, информацию с обучающим центром **Telwin Training Lab**, структурой для организации мероприятий по профессиональному обучению. **Telwin предлагает наиболее широкую и полную гамму продукции на рынке.**



telwin.com



MIT
Massachusetts
Institute of
Technology

**TELWIN & MIT:
Together
Towards
Innovation!**

2012-2013



solutions.
360°.



Industrial • Automotive • Charging • Professional • Consumer

TELWIN: worldwide presence.
TELWIN: presenti
nel mondo.





Telwin inverters



TECNICA 151/S

Draagbare inverter lasapparaten voor MMA lassen in gelijkstroom. Geleverd met lasaccessoires en koffer. Geschikt voor elektrodes: basisch, rutiel, inox, gietijzer. Licht en compact, hoge stabiliteit van de vlamboog, Arc Force, Hot Start, Anti-Stick, beveiligd tegen over- en onder voltage, motogenerator (max +/- 15%), thermische beveiliging.

Order nr.		830816202	830816203	830816204
Orig. nr.		TECNICA 151/S	TECNICA 171/S	TECNICA 211/S
Spanning	V	230	230	230
Inschakelduur (stroom @ 60%)	A	95		
Inschakelduur I _{max}	A @ %	130 @ 30%		
Regelbereik	A	5-130	5-150	10-170
Capaciteit elektroden	mm	1,6-3,2		
Opgenomen vermogen 60%/maximum	kW	2,6/3,9		
Nullastspanning	V	75	70	79
Krachtfactor	cos fi	0,7		
Beschermingsklasse	IP	21		
Mobiel		✓	✓	✓
Lastype		Elektrode		
Inschakelduur (stroom @ 60% bij 40°C)	A		95	105
Maximum inschakelduur (@ 40°)			25% @ 140A	18% @ 170A
Rutiel elektroden	mm		1,6-3,2	1,6-4
Elektroden voor inox	mm		1,6-3,2	1,6-4
Zekering op het net	A		16	16
Gewicht	kg	6,50	6,90	6,90
Afmetingen (l x b x h)	mm	380 x 420 x 170	380 x 420 x 170	380 x 420 x 170
Prijs	€	319,00	379,00	439,00

Draagbaar inverter lasapparaat voor MMA lassen in gelijkstroom. Bestemd voor het aansluiten op stroomgeneratoren en onstabiele stroomvoorziening (bijvoorbeeld lange verlengkabels). Heel geschikt voor bouwerven. Eenvoudig in gebruik met de meeste types van elektrodes: rutiel, basisch, inox, gietijzer. Compact en licht, zeer hoge stabiliteit van de lasstroom, ook bij spanningsschommelingen, Arc Force, Hot Start en Anti-Stick. Thermische beveiliging en beveiliging tegen overspanning en onderspanning. Geleverd met lasaccessoires en plastic koffer.



Order nr.	830816211 E	
Orig. nr.	FORCE 168 MPGE	
Spanning	V	230
Inschakelduur (stroom @ 60%)	A	70
Inschakelduur I _{max}	A @ %	140 @ 7%
Regelbereik	A	10-150
Capaciteit elektroden	mm	1,6-4,0
Opgenomen vermogen 60%/maximum	kW	1,6-4,0
Opgenomen stroom 60%/maximum	A	-/4,1
Nullastspanning	V	72
Kranchfactor	cos fi	0,6
Beschermingsklasse	IP	21
Minimum vermogen generator	kW	6
Lastype		Elektrode
Gewicht	kg	5,50
Afmetingen (l x b x h)	mm	380 x 420 x 170
Prijs	€	339,00

Draagbaar inverter lasapparaat voor MMA lassen in gelijkstroom . Bestemd voor het aansluiten op stroomgeneratoren en onstabiele stroomvoorziening (bijvoorbeeld lange verlengkabels). Geschikt voor bouwerven. Eenvoudig in gebruik met de meeste types van elektrodes: rutiel, basisch, inox, gietijzer. Compact en licht, zeer hoge stabiliteit van de lasstroom, ook bij voltageschommelingen, Arc Force, Hot Start en Anti-Stick. Thermische beveiliging en beveiliging tegen overspanning en onderspanning. Geleverd met lasaccessoires en plastic koffer.



Order nr.	830816212 E	
Orig. nr.	TECNICA188	
Spanning	V	230
Inschakelduur (stroom @ 60%)	A	95
Maximum inschakelduur (EN60974-1, bij 40°)	A	140@25%
Regelbereik	A	10-150
Opgenomen vermogen 60%/maximum	kW	2,6/4,2
Opgenomen stroom 60%/maximum	A	17/28
Nullastspanning	V	75
Kranchfactor	cos fi	0,86/0,7
Beschermingsklasse	IP	23
Capaciteit elektroden	mm	1,6/4
Gewicht	kg	7,00
Afmetingen (l x b x h)	mm	380 x 420 x 170
Prijs	€	419,00

Telwin transfo elektrodelasapparaten



MODERNA 150



Elektrodelasapparaten met koelventilatie. Voor MMA lassen in wisselstroom (AC). Traploze regeling van de lasroom. Thermische beveiliging. Bruikbare elektrodes: rutiel. Geleverd met elektrode lasaccessoires.

Order nr.	830809200 E	
Orig. nr.	MODERNA 150	
Spanning	V	230
Regelbereik	A	40-140
Opgenomen vermogen 60%/maximum	kW	-/2,5
Nullastspanning	V	48
Beschermingsklasse	IP	21
Capaciteit elektroden	mm	1,6-3,2
Lastype	Elektrode	
Gewicht	kg	13,90
Afmetingen (l x b x h)	mm	345 x 215 x 280
Prijs	€	132,00



NORDIKA 2160



Elektrodelasapparaten met koelventilatie. Voor MMA lassen in wisselstroom (AC). Traploze regeling van de lasroom. Thermische beveiliging. Bruikbare elektrodes: rutiel. Geleverd met elektrode lasaccessoires.

Order nr.	830814193 E	
Orig. nr.	NORDIKA 2160	
Spanning	V	230
Regelbereik	A	55-160
Opgenomen vermogen 60%/maximum	kW	-/2,5
Rutiel elektroden	mm	2,0-4,0
Nullastspanning	V	49
Isolatieklasse	H	
Beschermingsklasse	IP	21
Zekering op het net	16	
Gewicht	kg	17,20
Afmetingen (l x b x h)	mm	640 x 325 x 435
Prijs	€	169,00



NORDIKA 3250

Elektrodelasapparaten met koelventilatie. Voor MMA lassen in wisselstroom (AC). Traploze regeling van de lasroom. Thermische beveiliging. Bruikbare elektrodes: rutiel. Geleverd met elektrode lasaccessoires.

Order nr.	830814196 E	
Orig. nr.	NORDIKA 3250	
Spanning	V	230/400 1 ph
Regelbereik	A	55-250
Opgenomen vermogen 60%/maximum	kW	-/4,2
Rutiel elektroden	mm	2,0-5,0
Nullastspanning	V	50
Isolatieklasse	H	
Beschermingsklasse	IP	21
Gewicht	kg	21,70
Afmetingen (l x b x h)	mm	700 x 325 x 440
Prijs	€	259,00



Elektrodelasapparaat met koelventilatie op wielen. voor MMA lassen in wisselstroom (AC). Traploze regeling van de lasroom. Thermische beveiliging. Dubbel secundair voltage voor het lassen van basische elektrodes en rutiel. Geleverd met lasaccessoires.

Order nr.	830814095 E	
Orig. nr.	ARTIKA 282	
Spanning	V	230/400 1 ph
Inschakelduur (stroom @ 60%)	A	90
Maximum inschakelduur (EN60974-1, bij 40°)	A	220 @ 10%
Regelbereik	A	35-250
Opgenomen vermogen 60%/maximum	kW	2,7/8
Rutiel elektroden	mm	1,6-5,0
Basische elektroden	mm	1,6-5,0
Nullastspanning	V	70/78
Kranchfactor	cos fi	0,44
Isolatieklasse	H	
Beschermingsklasse	IP	22
Gewicht	kg	32,50
Afmetingen (l x b x h)	mm	750 x 360 x 490
Prijs	€	379,00

Autogene lasapparaten



Gecombineerde lasbrander en snijtoestel. Schacht diameter 17mm. Om te lassen van 0,5 - 9 mm en te snijden van 3 - 100 mm. Geleverd in plaatstalen koffer.

Order nr.	711700117
Orig. nr.	1700117
Gewicht	kg 1,00
Prijs	€ 312,00

Accessoires MMA



Laskabelset MMA voor Telwin en Metalworks.

Order nr.	Technische gegevens	Lasstroom	Prijs
		A	€
830801003	25mm ² 3+2m, DX25	tot 250 A - Nordika 3250	73,00
830801000	10mm ² 3+2m, DX25	tot 130	51,00
830801096	16mm ² 3+2m, DX25	tot 200	62,00
830801102	25mm ² 3+2m, DX25	tot 280	62,00
830801081	25mm ² 4+3m, DX50	tot 280	103,00
830801095	35mm ² 4+3m, DX50	tot 350	127,00
830801093	50mm ² 4+3m, DX50	tot 500	169,00

Lasbescherming



PVC lasscherm. Bescherming tegen UV, fel licht, en lasspatten metalen onderstel met wielen. Conform EN 1598.

Order nr.	830803508	830803509
Orig. nr.	803508	803509
Kleur	oranje	groen
Afmetingen scherm	mm 1740x1740	1740x1740
Afmetingen frame	mm 670x1790x1960	670x1790x1960
Gewicht	kg 7,80	7,80
Prijs	€ 123,00	123,00



Hittebestendige dekens. Bescherming tegen spatten, sprays, spaanders, etc... Hitte- en scheurbestendig.

Order nr.	830802678	830802679
Orig. nr.	802678	802679
Kleur	rood	rood
Maximum temperatuur	°C 550	1100
Afmetingen	mm 1530x1920	1530x1920
Gewicht	kg 3,00	1,60
Prijs	€ 37,00	102,00



Lasschoort.

Order nr.	830802550
Orig. nr.	802550
Gewicht	kg 0,50
Prijs	€ 29,00



Telwin MIG-MAG lasapparaten

Monofazige, ventilatorgekoeld lasapparaat voor hobby MIG-MAG lassen. Thermische bescherming. Universeel gebruik voor verschillende types van materialen zoals staal, inox en aluminium. Geleverd met rolletje lasdraad en gasregelaar voor hervulbare fles (zonder manometer en flesadaptor voor Nederlandse markt).



Order nr.	830821052 €	
Orig. nr.	TELMIG 150/1	
Spanning	V	230
Inschakelduur (stroom @ 60%)	A	55
Inschakelduur I _{max}	A @ %	115 @ 15%
Regelbereik	A	30-145
Opgenomen vermogen 60%/maximum	kW	1,4/3,7
Nullastspanning	V	31
Kranchfactor	cos φ	0,9
Beschermingsklasse	IP	21
Bobijn maximum	kg/mm	5/200
Capaciteit staal lasdraad	mm	0,6-0,8
Capaciteit inox lasdraad	mm	0,8
Capaciteit alu lasdraad	mm	0,8-1
Gewicht	kg	23,80
Afmetingen (l x b x h)	mm	730 x 370 x 475
Prijs	€	464,00



TELMIG 170/1



TELMIG 180/2



TELMIG 200/2

Gekoelde, compacte MIG-MAG lasapparaat. Voorzien voor continu lassen.
Voor verschillende types van materialen zoals staal, inox en aluminium.
Geleverd met rolletje draad en gasregelaar voor hervulbare fles.

Model 180/200: puntlasfunctie met regelbare timer.
Model 200: Met euro connector.



Order nr.		830821054 €	830821055 €	830821056 €
Orig. nr.		TELMIG 170/1	TELMIG 180/2	TELMIG 200/2
Spanning	V	230	230	230
Inschakelduur (stroom @ 60%)	A	80	80	100
Inschakelduur I _{max}	A @ %	140 @ 15%	140@20%	100@15%
Regelbereik	A	30-160	30-170	35-220
Opgenomen vermogen 60%/maximum	kW	2,3/5,2	2,3/5,2	3/7
Nullastspanning	V	31	31	33
Kranchfactor	cos φ	0,9	0,9	0,6
Beschermingsklasse	IP	21	21	22
Bobijn maximum	kg/mm	5/300	15/300	15/200
Capaciteit staal lasdraad	mm	0,6-0,8	0,6-0,8	0,6/1
Capaciteit inox lasdraad	mm	0,8	0,8	0,8
Capaciteit alu lasdraad	mm	0,8-1	0,8-1	0,8-1
Gewicht	kg	36,80	36,40	44,90
Afmetingen (l x b x h)	mm	800 x 450 x 570	800 x 450 x 570	800 x 450 x 655
Prijs	€	599,00	719,00	849,00



Inverter halfautomaat voor MIG-MAG, FLUX en brazeren-hardsolderen. Veelzijdig lastoestel met breed toepassingsveld voor het lassen van staal, alu, inox en brazeren-hardsolderen van verzinkt staal, koper, zink, ...

Synergische instelling van de materiaaldikte voor snel en gemakkelijk lassen met optimale lasparameters, met manueel regeling van de lasdikte.

Zeer compact en licht toestel. Thermische beveiliging en beveiliging tegen overspanning en onderspanning (max +/-15%)

Geleverd met lastoorts 2,5m, laskit voor staal en gasontspanner. Optioneel : trolley voor gemakkelijk transport, laskits voor alu of inox.



Order nr.	830816050 	
Orig. nr.	TECHNOMIG150	
Spanning	V	230
Inschakelduur (stroom @ 60%)	A	65
Regelbereik	A	20-150
Opgenomen vermogen 60%/maximum	kW	1,2/2,8
Opgenomen stroom 60%/maximum	A	8,7/20
Nullastspanning	V	52
Kranchfactor	cos fi	0,86/0,7
Beschermingsklasse	IP	23
Capaciteit staal lasdraad	mm	0,6/0,8
Capaciteit inox lasdraad	mm	0,8
Capaciteit alu lasdraad	mm	0,8/1
Geschikt voor lassen zonder gas		✓
Geschikt voor braseren		✓
Mobiel		✓
Inschakelduur (stroom @ 60%)	A	65
Maximum inschakelduur (EN60974-1, bij 40°)	A	115@20%
Gewicht	kg	11,00
Afmetingen (l x b x h)	mm	800 x 450 x 570
Prijs	€	509,00



Inverter halfautomaat voor MIG-MAG, FLUX en braseren-hardsolderen. Veelzijdig lastoestel met breed toepassingsveld voor het lassen van staal, alu, inox en braseren -hardsolderen van verzinkt staal, koper, zink, ...

Synergische instelling van de materiaaldikte voor snel en gemakkelijk lassen met optimale lasparameters, met manueel regeling van de lasdikte.

Zeer compact en licht toestel. Thermische beveiliging en beveiliging tegen overspanning en onderspanning (max +/-15%).

Geleverd met lastoorts 2,5m, laskit voor staal en gasontspanner. Optioneel : trolley voor gemakkelijk transport, laskits voor alu of inox.

Order nr.	830816051	
Orig. nr.	TECHNOMIG180	
Spanning	V	230
Inschakelduur (stroom @ 60%)	A	80
Regelbereik	A	30-170
Opgenomen vermogen 60%/maximum	kW	1,6/3,8
Opgenomen stroom 60%/maximum	A	12/24
Nullastspanning	V	62
Krachtfactor	cos fi	0,86/0,7
Beschermingsklasse	IP	23
Capaciteit staal lasdraad	mm	0,6/0,8
Capaciteit inox lasdraad	mm	0,8
Capaciteit alu lasdraad	mm	0,8/1
Geschikt voor lassen zonder gas		✓
Geschikt voor braseren		✓
Gewicht	kg	11,00
Afmetingen (l x b x h)	mm	800 x 450 x 570
Prijs	€	639,00



Draagbare inverter halfautomaat voor MIG-MAG lassen, FLUX (zonder gas) en brazeren-hardsolderen.

- Veelzijdig lastoestel met breed toepassingsveld voor het lassen van staal, alu, inox en brazeren -hardsolderen van verzinkt staal, koper, zink, ...
- Euroconnector lastoorts maakt het mogelijk snel van toorts en te verlassen materiaal te verwisselen.
- Digitaal display met snelle en gemakkelijke synergische instelling van de correcte lasparameters met de ONE TOUCH LCD technologie.
- 17 synergische lascurves in geheugen.
- Manuele selectie van materiaaldikte, draaddikte en gastype geven een optimale synergische keuze van lasstroom en -spanning. Lasstroom, draadsnelheid en lasvorm gemakkelijk manueel bijregelbaar afhankelijk van de voorkeuren van de lasser.
- Regelbare parameters: lasstroom, draaddikte, draadsnelheid, reactantie, draadversnelling, burn-back, post gaz en selectie 2 of 4-takt
- Zeer compact en licht toestel.
- Thermische beveiliging en beveiliging tegen overspanning en onderspanning (max +15%).
- Geleverd met lastoorts 3m, laskit voor staal en gasontspanner.
- Optioneel: trolley voor gemakkelijk transport, laskits voor alu of inox.

Order nr.		830816052 E
Orig. nr.		TECHNOMIG210
Spanning	V	230
Inschakelduur (stroom @ 60%)	A	105
Regelbereik	A	20/200
Opgenomen vermogen 60%/maximum	kW	2.5/5
Opgenomen stroom 60%/maximum	A	15/30
Nullastspanning	V	62
Efficiëntie	%	86
Kranchfactor	cos fi	0.7
Beschermingsklasse	IP	IP23
Bobijn maximum	kg/mm	5/200
Capaciteit staal lasdraad	mm	0.6/1
Capaciteit inox lasdraad	mm	0.8
Capaciteit alu lasdraad	mm	0.8/1
Gewicht	kg	11,00
Afmetingen (l x b x h)	mm	800 x 450 x 570
Prijs	€	879,00



NEW



Professionele inverter halfautomaat voor MIG-MAG lassen, FLUX (zonder gas), brazeren-hardsolderen en optioneel TIG (LIFT) lassen.

- Veelzijdig lastoestel met breed toepassingsveld voor het lassen van staal, alu, inox en brazeren -hardsolderen van verzinkt staal, koper, zink, ...
- Euroconnector lastoorts maakt het mogelijk snel van toorts en te verlassen materiaal te verwisselen.
- Digitaal display met snelle en gemakkelijke synergische instelling van de correcte lasparameters met de ONE TOUCH LCD technologie
- 17 synergische lascurves in geheugen.
- Manuele selectie van materiaaldikte, draaddikte en gastype geven een optimale synergische keuze van lasstroom en -spanning.
- Lasstroom, draadsnelheid en lasvorm gemakkelijk manueel bijregelbaar afhankelijk van de voorkeuren van de lasser.
- Regelbare parameters: lasstroom, draaddikte, draadsnelheid, reactantie, draadversnelling, burn-back, post gaz en selectie 2 of 4-takt.
- Optioneel TIG(LIFT) lassen mogelijk met de voorziene DX- klemmen.
- Met wielbasis en opzetplaat voor gasfles.
- Ruimte omkasting met 15kg bobijn capaciteit.
- Thermische beveiliging en beveiliging tegen overspanning en onderspanning (max +/-15%).
- Geleverd met lastoorts 3m, laskit voor staal en gasontspanner.
- Optioneel: trolley voor gemakkelijk transport, laskits voor alu of inox.

Order nr.		830816053
Orig. nr.		TECHNOMIG215
Spanning	V	230
Inschakelduur (stroom @ 60%)	A	105
Regelbereik	A	20-220
Opgenomen vermogen 60%/maximum	kW	2.6/5.2
Opgenomen stroom 60%/maximum	A	16/31
Nullastspanning	V	62
Efficiëntie	%	86
Kranchfactor	cos fi	0.7
Beschermingsklasse	IP	IP23
Bobijn maximum	kg/mm	15/300
Capaciteit staal lasdraad	mm	0.6/1
Capaciteit inox lasdraad	mm	0.8
Capaciteit alu lasdraad	mm	0.8/1
Lastype		MIG/flux/elektroden
Maximum inschakelduur (EN60974-1, bij 40°)	A	180A@20%
Gewicht	kg	11,00
Afmetingen (l x b x h)	mm	800 x 450 x 570
Prijs	€	-

Accessoires MIG-MAG



Lasset MIG-MAG voor het lassen van staal, inox, RVS.

Order nr.	Voor type	Laskit	Diameter rol mm	Prijs €
830802147	Bimax 152, 162, 182	Staal - wegwerpfles	0,6 - 0,8	52,00
830802148	Bimax 152, 162, 182	Staal - hervulbare fles	0,6 - 0,8	68,00
830802036	Bimax, Telmig 150/1, 170, 180/2	Alu (zonder draad-geleider)	0,8 - 1,0	54,00
830802037	Bimax Telmig / Digital Mig / d vol	Inox	0,6 - 0,8	48,00
830802115	Telmig 200/2, 251/2, 281/2 / Digital Mig 180	Aluminium	1	92,00
830802273	Mastermig 300, 400, 500	Aluminium	1-1,6	158,00



Lasset MIG-MAG

Order nr.	830802273			
Voor type	Mastermig 300, 400, 500			
Laskit	Aluminium			
Diameter rol	mm	1-1,6		
Prijs	€	158,00		



Lasset MIG-MAG voor het lassen van aluminium.

Order nr.	830802279			
Prijs	€	90,00		



Migtoortsen voor Telwin en Metalworks lastoestellen.

Order nr.	Voor type	Lengte Ampère		Aan-sluiting	Prijs €
		m	A		
830722039	Maxmig 180-203 (1 stroomkabel), oud type	2	180	intern	105,00
830742901	Telmig 150/1	2	160	intern	59,00
830742402	Bimax 152,162, Technomig 150 dual	2	160	intern	64,00
830742405	Telmig 180/2 en 170/1	2,5	180	intern	74,00
830742082	Bimax 182 / Technomig 180 DUAL	2,5	180	intern	87,00
830742180	Telmig 180/2, Telmig 200/2, 251/2, technomig 210, 215 dual en Metalworks Premium Mig 160	3	220	euro	93,00
830742181	Telmig 200/2, 251/2, technomig 210, 215 dual en Metalworks Premium Mig 160	4	220	euro	104,00
830742182	Digital Mig 220	5	220	euro	122,00
830742183	Telmig 281/2, Mastermig 270/2, 300	3	270	euro	106,00
830742184	Telmig 281/2, Mastermig 270/2, 300	4	270	euro	126,00
830742185	Telmig 281/2, Mastermig 270/2, 300	5	270	euro	148,00
830742186	Mastermig 400, Inerpulse 320, Digital Supermig 360	3	400	euro	145,00
830742187	Mastermig 400, Inerpulse 320, Digital Supermig 360	4	400	euro	170,00
830742188	Mastermig 400, Inerpulse 320, Digital Supermig 360	5	400	euro	197,00
830722798	Digital Supermig 460, 560, Inerpulse 420	3	500	euro	309,00
830722800	Digital Supermig 460, 560, Inerpulse 420	5	500	euro	379,00



Lastips voor Telwin en Metalworks toestellen. Besteleenheid : per 20 stuks.

Order nr.	Voor type	Diameter mm	Om-schrijving	VE	Min. be-stelhoe-veelheid	Prijs/VE €
830722415	Bimax, Telmig, Digital MIG, Technomig, Metalworks Premium MIG 160	0,6	Staal	1	20	1,00
830722416	Bimax, Telmig, Digital MIG, Technomig, Metalworks Premium MIG 160	0,8	Staal	1	20	1,00
830722680	Mastermig, Telmig 281/2	0,8	Staal	1	20	2,00
830722705	Telmig 200/2, 251/2, Digital Mig 220	1,0	Staal	1	20	1,40
830722681	Mastermig, Digital supermig 360	1,0	Staal	1	20	2,00
830722682	Mastermig, Digital supermig 360	1,2	Staal	1	20	2,70
830722797	Mastermig 400	1,6	Staal	1	20	2,00
830722556	Bimax, Telmig, Mastermig, Digital Mig, Technomig	0,8	Aluminium	1	20	2,80
830722552	Bimax, Telmig, Mastermig, Digital Mig, Technomig	0,9	Aluminium	1	20	2,80
830722553	Bimax, Telmig, Mastermig, Digital Mig, Technomig	1,2	Flux	1	20	2,80
830722818	Mastermig 400, Digital supermig 360	1,6	Aluminium	1	20	2,70



Lasbekken voor MIG/MAG Telwin en Metalworks lasapparaten.

Order nr.	Voor type	Omschrijving	VE	Min. bestelhoeveelheid	Prijs/VE
					€
830722423 E	Bimax, Telmig, Digital Mig, Technomig dual, Metalworks Premium MIG 160	Conische bek (3)	1	10	5,00
830722685 E	Telmig 281/2, Mastermig 270/2, 300	Conische bek (3)	1	10	5,40
830722792 E	Mastermig 400, Digital supermig 360	Conische bek (3)	1	10	12,00
830722149 E	Bimax, Telmig, Digital Mig, Technomig dual	Cilindrische bek - 16mm (4)	1	10	4,30
830722684 E	Telmig 281/2, Mastermig 270/2, 300	Cilindrische bek - 18mm (4)	1	10	5,90
830722151 E	Bimax, Telmig, Digital Mig, Technomig Dual	Bek met versmalde hals (5)	1	1	12,50
830722686 E	Telmig 281/2, Mastermig 270/2, 300	Bek met versmalde hals (5)	1	1	10,90
830722793 E	Mastermig 400, Digital supermig 360	Bek met versmalde hals (5)	1	1	16,00
830722672 E	Bimax, Telmig, Digital Mig, Technomig Dual	Bek voor spotwelding nagels (6)	1	1	22,00
830722150 E	Bimax, Telmig, Digital Mig, Technomig Dual	Bek voor spotwelding (7)	1	1	12,00
830722687 E	Telmig 281/2, Mastermig 270/2, 300	Bek voor spotwelding (7)	1	1	13,90
830722794 E	Mastermig 400, Digital supermig 360	Bek voor spotwelding (7)	1	1	22,00



Zwanehals voor toortsen

Order nr.	Voor type	Prijs
		€
830722078 E	Bimax 152, 162 / Telmig 180/2, 150/1, 170, Technomig 150 / Dual, 180 / Dual, 210/215	15,00
830722305 E	Bimax 182, Telmig 200/2, 251/2, Digital Mig, Premium MIG 160, Technomig 150 / Dual, 180 / Dual, 210/215	16,00
830722696 E	Telmig 281/2, Mastermig 270/2, 300	39,00
830722788 E	Mastermig 400, Digital supermig 360	88,00



Veren voor zwanehals

Order nr.	830722319 E	830722690 E
Voor type	Bimax, Digital Mig, Technomig Dual, Premium MIG 160	Telmig 281/2, Mastermig 270/2, 300
Prijs	€ 3,00	4,50



Gasdiffusor voor toortsen

Order nr.	830722688 E	830722791 E
Voor type	Technomig 210/215 DUAL, Telmig 281/2, Mastermig 270/2, 300	Mastermig 400, Digital supermig 360
Prijs	€ 5,80	7,20



Draadgeleiders voor toorts

Order nr.	Voor type	Diameter mm	Lengte m	Prijs
				€
830722077 E	Bimax 152, 162, Technomig 150 dual	0,6-0,8	3	4,80
830742412 E	Telmig 150/1	0,6-0,8	3	4,80
830722437 E	Telmig 200/2, 251/2, 281/2, Technomig 210, 215 dual Digital Mig, Mastermig, Premium MIG 160	0,6-0,8	3	7,50
830742413 E	Telmig 180/2, 170/1	0,6-0,8	3	3,90
830742422 E	Bimax 182, Technomig 180 dual	0,6-0,8	3	5,90
830722795 E	Mastermig 400	1,2-1,6	3	11,00
830722689 E	Telmig 200/2, 251/2, 281/2, Technomig 210, 215 dual, Digital Mig, Mastermig, Premium MIG 160	1,0-1,2	3	10,00
830722516 E	Telmig 200/2, 251/2, 281/2, Technomig 210, 215 dual, Digital Mig, Mastermig, Premium MIG 160	1,0-1,2 ALU	3	44,50
830722597 E	Mastermig 400	1,2-1,6 ALU	3	36,00



Wegwerp-gasflessen. 1L. Voor gebruik met adapter voor wegwerp-flessen.

Order nr.	830802038 E	830802048 E	830802050 E
Omschrijving	1L CO2	1L Menggas Argon CO2	1L Menggas Argon
Prijs	€ 26,00	26,00	26,00

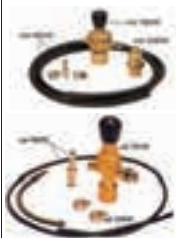

Laskit.

Order nr.	830802032 E	830802708 E
Omschrijving	wegwerpfles	hervulbare fles
Prijs	€ 33,00	48,00



Gasregelaar zonder manometer.

Order nr.	830722120	830722341
Voor type	wegwerpfles	her vulbare fles
Prijs	€ 27,50	36,00



Gasregelaar met manometer.

Order nr.	830722119	830722346
Type	standaard	industrial
Prijs	€ 54,00	89,00



Gasfles adaptor voor gasregelaar. Deze adaptor laat u toe om onze drukregelaars aan te sluiten op her vulbare flessen op de Nederlandse markt.

Order nr.	830432160
Voor type	her vulbare flessen
Prijs	€ 10,00



Trolley voor gebruik met Telwin Technomig halfautomaten.

Order nr.	830803059
Voor type	technomig
Prijs	€ 259,00



PTE18



PTE28



PCP28





Telwin FLUX-MIG lasapparaten



BIMAX 152 TURBO

MIG-MAG en FLUX halfautomaten op wielen. Zowel lassen met gas als flux lassen zonder gas is mogelijk met deze toestellen. Standaard uitgerust voor het FLUX-lassen zonder beschermgas met gevulde lasdraad. Ventilatorgekoeld en met thermische bescherming. Geleverd met rolletje FLUX-draad. MIG-MAG lassen met gas is mogelijk via de optionele laskits voor staal, inox of alu. Geleverd met wielen.

Order nr.	830821011	
Orig. nr.	BIMAX 152 TURBO	
Spanning	V	230
Inschakelduur (stroom @ 60%)	A	55
Inschakelduur I _{max}	A @ %	115 @ 15%
Regelbereik	A	30-145
Opgenomen vermogen 60%/maximum	kW	1,4/3,7
Nullastspanning	V	31
Krachtfactor	cos φ	0,9
Beschermingsklasse	IP	21
Bobijn maximum	kg/mm	5/200
Capaciteit staal lasdraad	mm	0,6-0,8
Capaciteit inox lasdraad	mm	0,8
Capaciteit alu lasdraad	mm	0,8-1
Capaciteit gevulde lasdraad	mm	0,8-1,2
Geschikt voor lassen zonder gas		✓
Mobiel		✓
Lastype		MIG+FLUX
Gewicht	kg	23,30
Afmetingen (l x b x h)	mm	730 x 370 x 475
Prijs	€	434,00



BIMAX 162 TURBO



MIG-MAG en FLUX halfautomaten op wielen. Zowel lassen met gas als flux lassen zonder gas is mogelijk met deze toestellen. Standaard uitgerust voor het FLUX-lassen zonder beschermgas met gevulde lasdraad. Ventilatorgekoeld en met thermische bescherming. Geleverd met rolletje FLUX-draad. MIG-MAG lassen met gas is mogelijk via de optionele laskits voor staal, inox of alu. Geleverd met wielen. Met metaalplaat om gasfles te vervoeren.

Order nr.	830821012 E	
Orig. nr.	BIMAX 162 TURBO	
Spanning	V	230
Inschakelduur (stroom @ 60%)	A	55
Regelbereik	A	30-145
Opgenomen vermogen 60%/maximum	kW	1,4/3,7
Nullastspanning	V	31
Kranchfactor	cos fi	0,9
Beschermingsklasse	IP	21
Bobijn maximum	kg/mm	5/200
Mobiel		✓
Inschakelduur (stroom @ 60%)	A	55
Maximum inschakelduur (EN60974-1, bij 40°)	A	15% @ 115
Staal lasdraad	mm	0,6-0,8
Inox lasdraad	mm	0,8
Alu lasdraad	mm	0,8-1
Gevulde lasdraad	mm	0,8-1,2
Regelstanden		4
Zekering op het net		16
Isolatieklasse		H
Gewicht	kg	24,80
Afmetingen (l x b x h)	mm	640 x 350 x 470
Prijs	€	469,00



BIMAX 182 TURBO

MIG-MAG en FLUX halfautomaten op wielen. Zowel lassen met gas als flux lassen zonder gas is mogelijk met deze toestellen. Standaard uitgerust voor het FLUX-lassen zonder beschermgas met gevulde lasdraad. Ventilatorgekoeld en met thermische bescherming. Geleverd met rolletje FLUX-draad. MIG-MAG lassen met gas is mogelijk via de optionele laskits voor staal, inox of alu. Geleverd met wielen. Met metaalplaat om gasfles te vervoeren.

Order nr.	830821013 E	
Orig. nr.	BIMAX 182 TURBO	
Spanning	V	230
Regelbereik	A	30-170
Opgenomen vermogen 60%/maximum	kW	2,3/5,2
Nullastspanning	V	31
Krachtfactor	cos fi	0,9
Beschermingsklasse	IP	21
Bobijn maximum	kg/mm	15/300
Mobiel		✓
Inschakelduur (stroom @ 60%)	A	80
Maximum inschakelduur (EN60974-1, bij 40°)	A	20% @ 140
Staal lasdraad	mm	0,6-0,8
Inox lasdraad	mm	0,8
Alu lasdraad	mm	0,8-1
Gevulde lasdraad	mm	0,8-1,2
Regelstanden		6
Zekering op het net		16
Isolatieklasse		H
Prijs	€	729,00

Telwin TIG lasapparaten



TECNICA TIG 160 DC - HF / LIFT

Draagbaar TIG inverter lasapparaat, voor TIG en MMA lassen in gelijkstroom (DC) met HF-boog (hoge frequentie) of LIFT. Geschikt voor lassen met staal, inox, titanium, koper, nikkel en hun legeringen. Geleverd met TIG laskit. Belangrijkste eigenschappen: arc force, 2/4 takt. Hot start en anti-stick. Voorzien voor afstandsbediening. Automatische controle bij het opstarten. Thermische beveiliging en beveiliging tegen overspanning en onderspanning. Niet geschikt voor aluminium lassen in TIG.

Order nr.		830815957 
Orig. nr.		TTIG 160DC-HF/LIFT
Spanning	V	230
Inschakelduur (stroom @ 60%)	A	75
Maximum inschakelduur (EN60974-1, bij 40°)	A	130 @ 15%
Regelbereik	A	5-130
Opgenomen vermogen 60%/maximum	kW	1,7/3,7
Opgenomen stroom 60%/maximum	A	13/25
Nullastspanning	V	93
Kranchfactor	cos fi	0,6
Rendement	eta	0,8
Isolatieklasse		H
Beschermingsklasse	IP	21
Kenmerken		TIG/elektroden
Gewicht	kg	10,00
Afmetingen (l x b x h)	mm	335 x 130 x 230
Prijs	€	899,00

MACHINES



TECHNOLOGY TIG 230 DC - HF / LIFT



Draagbaar TIG inverter lasapparaat, voor TIG en MMA lassen in gelijkstroom (DC) met HF-boog (hoge frequentie) of LIFT. Geschikt voor lassen met staal, inox, titanium, koper, nikkel en hun legeringen. Geleverd met TIG-toorts, gasontspanner met dubbele manometer en massaklem. Instelbare parameters: arc force, 2/4 takt. Hot start en anti-stick, bilevel, optionele pulse. Voorzien voor afstandsbediening. Bruikbare elektrodes in MMA: basische elektrodes, rutiel, inox, gietijzer. Automatische controle bij het opstarten. Thermische beveiliging en beveiliging tegen overspanning en onderspanning. Niet geschikt voor aluminium lassen in TIG.

Order nr.		830815038 €
Orig. nr.		TTIG230DC-HF/LIFT
Spanning	V	230
Inschakelduur (stroom @ 60%)	A	125
Maximum inschakelduur (EN60974-1, bij 40°)	A	220 @ 30%
Regelbereik	A	5-220
Opgenomen vermogen 60%/maximum	kW	3,6/5,5
Opgenomen stroom 60%/maximum	A	24/33
Nullastspanning	V	87
Krachtfactor	cos fi	0,6
Rendement	eta	0,83
Isolatieklasse		H
Beschermingsklasse	IP	23
Lastype		TIG/elektroden
Gewicht	kg	8,50
Afmetingen (l x b x h)	mm	385 x 150 x 360
Prijs	€	939,00



TECHNOLOGY TIG 182

Draagbaar TIG inverter lasapparaat voor lassen in wisselstroom AC en DC gelijkstroom. Met koelventilator, gestuurd door microprocessor, PULSE TIG, en MMA lassen met de mogelijkheid tot HF-boog (hoge frequentie) of LIFT. Geschikt voor lassen met staal, inox, ALUMINIUM, titanium, koper, nikkel, magnesium en hun legeringen. Geleverd met TIG-toorts, gasontspanner met dubbele manometer en massaklem. Instelbare parameters: Post gas, down slope, bi-level, arc-force. 2/4 takt. Beschikt over hot start en anti-stick. Voorziening voor afstandsbediening. Bruikbare elektrodes in MMA: basische elektrodes, rutiel, inox, gietijzer. Thermische beveiliging en beveiliging tegen overspanning, onderspanning en overbelasting.

Order nr.		830815332	830815476
Orig. nr.		TTIG182AC/DC-HF/LIFT	TTIG222AC/DC-HF/LIFT
Spanning	V	230	230
Inschakelduur (stroom @ 60%)	A	85	100
Regelbereik	A	160 @ 20%	5-200
Opgenomen vermogen 60%/maximum	kW	2,5/4,3	3/5,5
Opgenomen stroom 60%/maximum	A	18/29	20/34
Nullastspanning	V	94	100
Kranchfactor	cos fi	0,7	0,6
Rendement	eta	0,75	0,77
Isolatieklasse			H
Beschermingsklasse	IP	23	23
Inschakelduur I _{max}	A @ %	160 @ 20%	
Capaciteit elektroden	mm	5-160	
Geschikt voor alu		✓	✓
Mobiel		✓	✓
Lastype		TIG/elektroden	TIG/elektroden
Gewicht	kg	9,70	12,80
Afmetingen (l x b x h)	mm	430 x 170 x 340	430 x 170 x 340
Prijs	€	1.499,00	1.999,00

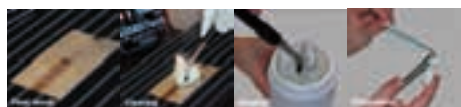

PERFECTE LASNADEN

TIG-Cleaning set "Cleantech 100" voor het nabehandelen van lasnaden. Uiterst geschikt voor het reinigen van TIG en MIG lasnaden op roestvrij staal. Inwerking van hitte, vlamboog en andere materiaal aantasting worden moeiteloos weggevoerd tot een prachtig eindresultaat. Geleverd in koffer met generator, toorts, vezelstrip kit, reinigingsvloeistof en verdeelkan. Snelle en mooie reiniging.

Order nr.		830850000 €
Orig. nr.		850000
Frequentie	Hz	50-60
Spanning	V	230
Aantal standen		2
Gewicht	kg	14,40
Afmetingen (l x b x h)	mm	34,5 x 21,5 x 28
Prijs	€	389,00



Slijptoestel voor TIG elektrodes.

- Voor het slijpen van TIG elektroden Ø 1,0 tot 4,0mm.
- Geslepen elektrodes zorgen voor een stabiele vlamboog en optimale lasresultaten.
- Minimaal materiaalverlies van slechts 0,3mm.
- Elektroden tot 200x slijpbaar in plaats van 50 -100x met de hand.
- Slijphoek traploos instelbaar van 15°-180°.
- Korte elektroden tot 15mm nog slijpbaar (bijvoorbeeld voor rondlassen).
- Verhit of brandt de elektrodes niet uit.
- **Geïntegreerde afzuiging met P3 stoffilter voorkomt inademen van stofdeeltjes.**
- Precieze en stevige klemming van de elektrode, voor een optimale veiligheid.
- Met zichtvenster ter controle van het slijpproces.
- Diamantsteen met 3 niveaus, dus 3 keer langere standtijd.
- Las- of metaaldruppels op de elektrode worden eenvoudig mee weggeslepen.
- Sterke 850W motor.

Geleverd met:

Slijpkop met filterbehuizing en filter.

Elektrodehouder.

Diamantschijf Ø 40 mm.

Spantangen voor Elektrodes 1,6/2,4/3,2 mm.

Gereedschap, 2 x inbusleutel 8/4 mm, 2 x steeksleutel 13-17 / 13-14.

Kunststof koffer.



Order nr.		711690100 €
Orig. nr.		1690100
Spanning	V	230
Toerental	min-1	8.000-32.000
Vermogen motor	W	850
Instelbare slijphoek	°	15-180
Lengte elektrode	mm	min. 15
Elektrode diameter	mm	1.0-4.0
Diamantschijf	mm	Ø 40
Gewicht	kg	2,50
Prijs	€	895,00

Accessoires TIG



Complete lassets TIG

Order nr.	Voor type	Type	Prijs €
830801097	Tecnica 114, 164, 150, 168 GE Technology 175, 210, 220/S, 228CE/GE (Zonder HF) PREMIUM 170, MIG 160	ST9V	169,00
830802415	Tecnica TIG 155 / TIG 160 / Technology TIG 182, 185	ST17	199,00
830802489	Technology Tig 230	ST26	255,00
830802607	Technology Tig 222	ST26	255,00



Tig toortsen voor Telwin en Metalworks.

Order nr.	Omschrijving	Voor type	Lengte DX tip m	Prijs €
830722563	toorts ST9V	zonder HF: Tecnica, Technology, Metalworks TEC / Premium	4 25	100,00
830742058	toorts ST17	Superior 260 CE (zonder HF)	4 50	124,00
830742423	toorts ST17	Tecnica Tig 155, Technology Tig 230	4 25	112,00
830742424	toorts ST26	Technology Tig 172, 180	4 50	114,00
830742427	toorts ST26	Superior 300 CE, Inverpulse 420 (zonder HF)	4 50	146,00
830742431		Superior 300 CE, Inverpulse 420 (zonder HF)	8 50	207,00



Wisselstukken voor TIG toorts 83072-2563

Order nr.	Omschrijving	Diameter nr	Prijs €
830802220	DC, grijze Cerium-Tungsten elektrodes 1,0 (a)		19,50
830802222	DC, grijze Cerium-Tungsten elektrodes 1,6 (a)		33,00
830802223	DC, grijze Cerium-Tungsten elektrodes 2,4 (a)		67,00
830802233	DC, grijze Cerium-Tungsten elektrodes 3,2 (a)		113,00
830802234	AC, groene Wolfram elektrodes 1,0 (b)		18,00
830802235	AC, groene Wolfram elektrodes 1,6 (b)		34,00
830802236	AC, groene Wolfram elektrodes 2,4 (b)		76,00
830802237	AC, groene Wolfram elektrodes 3,2 (b)		136,00
830802238	AC, groene Wolfram elektrodes 4,0 (b)		215,00
830802239	elektrode houders 1,0 (c)		3,80
830802240	elektrode houders 1,6 (c)		3,80
830802241	elektrode houders 2,4 (c)		3,80
830802242	elektrode houders 3,2 (c)		3,80
830802243	elektrode houders 4,0 (c)		3,80
830802249	gasdiffusor 1,0 (d)		7,60
830802250	gasdiffusor 1,6 (d)		7,60
830802251	gasdiffusor 2,4 (d)		7,60
830802252	gasdiffusor 3,2 (d)		7,60
830802253	gasdiffusor 4,0 (d)		7,60
830802244	keramische bek nr. 4 (e)		10,00
830802245	keramische bek nr. 6 (e)		10,00
830802246	keramische bek nr. 7 (e)		10,00
830802247	keramische bek nr. 8 (e)		10,00
830802248	keramische bek nr. 10 (e)		10,00



Wisselstukken voor Telwin TIG en PREMIUM TIG180 toortsen.

Order nr.	Omschrijving	Prijs €
830802220	DC, grijze Cerium-Tungsten elektrodes 1,0 (a)	19,50
830802222	DC, grijze Cerium-Tungsten elektrodes 1,6 (a)	33,00
830802232	DC, grijze Cerium-Tungsten elektrodes 2,4 (a)	67,00
830802233	DC, grijze Cerium-Tungsten elektrodes 3,2 (a)	113,00
830802234	AC, groene Wolfram elektrodes 1,0 (b)	18,00
830802235	AC, groene Wolfram elektrodes 1,6 (b)	34,00
830802236	AC, groene Wolfram elektrodes 2,4 (b)	76,00
830802237	AC, groene Wolfram elektrodes 3,2 (b)	136,00
830802238	AC, groene Wolfram elektrodes 4,0 (b)	215,00
830802239	elektrode houders 1,0 (c)	3,80
830802240	elektrode houders 1,6 (c)	3,80
830802241	elektrode houders 2,4 (c)	3,80
830802242	elektrode houders 3,2 (c)	3,80
830802243	elektrode houders 4,0 (c)	3,80
830802249	gasdiffusor 1,0 (d)	7,60
830802250	gasdiffusor 1,6 (d)	7,60
830802251	gasdiffusor 2,4 (d)	7,60
830802252	gasdiffusor 3,2 (d)	7,60
830802253	gasdiffusor 4,0 (d)	7,60
830802244	keramische bek nr. 4 (e)	10,00
830802245	keramische bek nr. 6 (e)	10,00
830802246	keramische bek nr. 7 (e)	10,00
830802247	keramische bek nr. 8 (e)	10,00
830802248	keramische bek nr. 10 (e)	10,00



Accessoires voor Telwin TIG-Cleaning set "Clean Tech"

Order nr.	830322905	830980320	830742384
Omschrijving	Cleantech vloeistof 3l	Cleantech strips (10 stuks)	reinigingskop CleanTech 100
Prijs €	26,00	36,00	24,00

Telwin puntlasapparaten

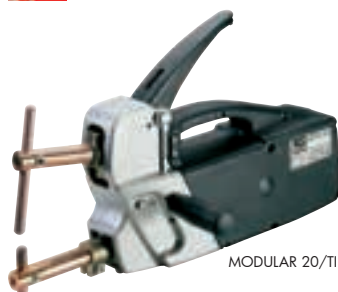

MODULAR 20/TI



Puntlasapparaat, met elektronische controle van de puntlastijd. Synchrone elektronische timer, met puntlastijd instelbaar van 0,1 sec. tot 1,2 sec. Druk op de armen instelbaar van 40 tot 120 kg. Handvat thermisch isolerend.

Belangrijkste eigenschappen: Automatische regeling van de lastijd en lasstroom. Regeling lastijd. Keuze tussen continu/puls werking (voor plaatijzer met high-stress rekpunten en gegalvaniseerd staal). Druk op de armen instelbaar van 40 tot 120kg. Handvat thermisch isolerend. Standaard geleverde armen: L. 120mm.

Order nr.	830823015 €	
Orig. nr.	MODULAR 20/TI	
Spanning	V	230
Inschakelduur I _{max}	A @ %	1,5
Kranchfactor	cos fi	0,9
Beschermingsklasse	IP	20
Maximum puntlasstroom	A	3800
Maximum puntlasdikte	mm+mm	1,0+1,0
Secundaire nullastspanning	V	2
Geschikt voor staal		✓
Geschikt voor RVS		✓
Geschikt voor alu		✓
Gewicht	kg	10,00
Afmetingen (l x b x h)	mm	440 x 100 x 185
Prijs	€	559,00

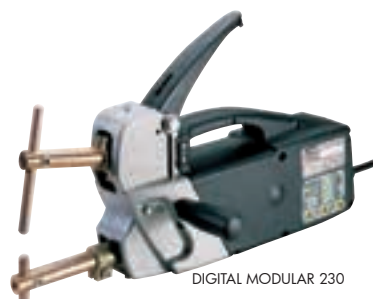

DIGITAL MODULAR 230



Draagbare puntlas apparaten, gestuurd door microprocessor. Controle systeem "FUZZY LOGIC" voor eenvoudiger gebruik en een superieure kwaliteit. Ontworpen voor puntlassen van plaatmateriaal met een dikte van maximum 2 + 2 mm.

Belangrijkste eigenschappen: Automatische regeling van de lastijd en lasstroom. Regeling lastijd. Keuze tussen continu/puls werking (voor plaatijzer met high-stress rekpunten en gegalvaniseerd staal). Druk op de armen instelbaar van 40 tot 120kg. Handvat thermisch isolerend. Standaard geleverde armen: L. 120mm.

Order nr.	830823016 €		830823017 €	
Orig. nr.	DIGITAL MODULAR 230		DIGITAL MODULAR 400	
Spanning	V	230	400 1ph	
Kranchfactor	cos fi	0,9	0,9	
Beschermingsklasse	IP	20	20	
Maximum puntlasstroom	A	6300	6300	
Maximum puntlasdikte	mm+mm	2,0+2,0	2,0+2,0	
Secundaire nullastspanning	V	2,5	2,5	
Geschikt voor staal		✓	✓	
Geschikt voor RVS		✓	✓	
Geschikt voor alu		✓	✓	
Maximum inschakelduur (EN60974-1, bij 40°)	%	1,5	1,5	
Maximum opgenomen vermogen	kW	13	13	
Zekering op het net	A	25	16	
Isolatieklasse		B	B	
Gewicht	kg	10,50	10,30	
Afmetingen (l x b x h)	mm	440 x 100 x 185	440 x 100 x 185	
Prijs	€	795,00	769,00	



Puntlasapparaat, gestuurd door microprocessor voor toepassingen in de carrosserie. Het multifunctionele controlepaneel laat de automatische regeling toe van puntlasparameters in functie van het gekozen werktuig en de dikte van het plaatijzer. Geleverd met "STUDDER" kit BASIC voor lassen van nagels, schroeven, sluitringen, rivetten en speciale sluitringen, opwarming van plaatijzer, Stuiking en verstellen. Perfect dus om een eenvoudige en complexe builen te repareren.



Order nr.		830823252	830823000
Orig. nr.		DIGCARSPOTTER5500P2	DIGCARSPOTTER5500P4
Spanning	V	230	400 1ph
Nullastspanning	V	5,4	5,4
Krachtfactor	cos fi	0,7	0,7
Beschermingsklasse	IP	22	22
Maximum puntlasstroom	A	3000	3000
Maximum puntlasdikte	mm+mm	1,5+1,5	1,5+1,5
Geschikt voor staal		✓	✓
Geschikt voor RVS		✓	✓
Geschikt voor alu		✓	✓
Maximum inschakelduur (EN60974-1, bij 40°)	%	3,0	3,0
Maximum opgenomen vermogen	kW	11	11
Zekering op het net	A	16	16
Isolatieklasse		H	H
Gewicht	kg	30,00	29,60
Afmetingen (l x b x h)	mm	390 x 260 x 225	390 x 260 x 225
Prijs	€	1.100,00	1.340,00

Intelligente inductieverwarmer met ruim toepassingsveld in de carrosserie en algemeen reparatiewerk. Door inductieverwarmen kunt u snel allerlei materialen snel losmaken, zonder het oppervlak te beschadigen of vervormen: autoruiten, stickers, plastic, roestige bouten of rollager, kleine deukjes door hagelstenen, etc. Eenvoudig in gebruik: automatische regeling van de intensiteit en de activiteitscyclus. Bescherm de zone rondom het te bewerken punt optimaal. Brengt geen schade toe aan geverfde oppervlakken, glas, rubber of plastic op het voertuig. Warmt de oppervlakten niet onnodig op.

Geleverd met: Tools voor het losmaken van ramen, bouten, inductiedoek en hakenset (3 stuks).

Zie website voor alle product voordelen & vele toepassing foto's.



Order nr.		830835010
Orig. nr.		SMART INDUCTOR 5000
Spanning	V	200/240 1ph
Beschermingsklasse	IP	21
Maximum opgenomen vermogen	kW	2,4
Isolatieklasse		H
Frequentie	kHz	35-100
Gewicht	kg	10,30
Afmetingen (l x b x h)	mm	390 x 260 x 230
Prijs	€	1.989,00

Accessoires puntlassen



Lasrivetten voor spotters. VE = verpakkingseenheid.

Order nr.	Omschrijving	VE	Prijs/VE €
830802297	Rivet 3 x 3,2 mm	100	10,00
830802298	Rivet 3 x 4,5 mm	100	10,00
830802299	Rivet 5 x 10 mm	100	13,00
830802302	Rivet 5 x 12 mm	100	13,00
830802303	Rivet 5 x 18 mm	100	13,00
830802304	Rivet 5 x 25 mm	100	16,00
830802295	100 sluitringen fe-cu d. 8x16	100	10,00
830802296	100 driehoek sluitringen fe-cu	100	64,00
830802300	Rivet 4 x 15 mm	100	13,00
830802301	Rivet 5 x 18 mm	100	13,00
830802339	Spiraaldraad	50	56,00
830802293	Nagels 2 x 50 mm	100	8,00
830143276	Nagel- en rivettenset	1	254,00



Accessoire. Waterkoeling GRA901 voor Digital spotter 9000, PTE en PCP.

Order nr.	830802043
Prijs	€ 719,00



Complete studder box voor Digital Car Spotter 5500 plus.

Order nr.	830143593
Prijs	€ 82,00



Aluspotter consumables kit voor Alucar 5100 en Aluspotter 6100

Order nr.	830143440
Prijs	€ 488,00

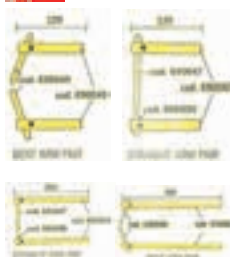

Paar armen met elektrodes voor MODULAR 20/TI-230-400 .

Order nr.	Lengte mm	Prijs €
830803150	120	94,00
830803151	120	76,00
830803152	250	149,00
830803153	350	169,00
830803154	350	152,00
830803155	120	119,00
830803156	500	224,00
830803158	120	102,00
830803159	140	166,00



Optioneel Alupull systeem

Order nr.	830802433	830722952
Prijs	€ 435,00	50,00

Telwin plasma branders

Dragbare plasmasnijder op gecomprieeerde lucht, met koelventilator en contact striking. Voor snel snijden en zonder vervorming van alle geleidende materialen zoals staal, inox, gegalvaniseerd metaal, aluminium, koper, messing. Voorzien van een ingebouwde compressor. Belangrijkste eigenschappen: Beperkt gewicht en grootte. Alarmlicht bij ondervoltage van de toorts, beveiligingen. Aanduiding van de luchtdruk. Thermische beveiliging en beveiliging tegen overspanning, onderspanning en overbelasting. Geleverd met toorts van 4m.



TECNICA PLASMA 34 K

TECHNOLOGYPLASMA54K

Order nr.		830815084	830815088
Orig. nr.		TECNICA PLASMA 34 K	TECHNOLOGYPLASMA54K
Spanning	V	230	230
Maximum snijdikte (*)	mm	6	10
Maximum inschakelduur (EN60974-1, bij 40°)	A	20 @ 25%	35@30%
Regelbereik	A	5-25	7-40
Maximum opgenomen vermogen	kW	2,8	4,5
Maximum opgenomen stroom	A	18	27,5
Zekering op het net	A	16	
Nullastspanning	V	430	380
Krachtfactor	cos fi	0,7	0,7
Rendement	eta	0,8	0,7
Isolatieklasse		H	H
Beschermingsklasse	IP	23	23
Gewicht	kg	12,70	16,80
Afmetingen (l x b x h)	mm	475 x 170 x 340	550 x 170 x 340
Prijs	€	990,00	1.189,00

Dragbare plasma inverter. Snijsystemen op gecomprieeerde lucht, met koelventilator en contact striking, gestuurd door microprocessor. Voor snel snijden en zonder vervormingen van alle geleidende materialen zoals staal, inox, gegalvaniseerd metaal, aluminium, koper, messing. Belangrijkste eigenschappen: Beperkt gewicht en grootte. Alarmlicht bij ondervoltage van de toorts, beveiligingen. Mogelijkheid tot snijden op traliewerk met automatisch herstarten van de boog. Thermische beveiliging en beveiliging tegen overspanning, onderspanning, overbelasting, toorts kortsluiting. Geleverd met toorts van 4m en drukregelaar.



Order nr.		830815014	830815493
Orig. nr.		TECNICA PLASMA 31	TECHNOLOGYPLASMA41
Spanning	V	230	230
Maximum snijdikte (*)	mm	8	12
Maximum inschakelduur (EN60974-1, bij 40°)	A	20% @ 25	30% @ 35
Regelbereik	A	5-25	7-40
Luchtverbruik	l/min	100	100
Werkdruk	bar	5-6	4-5
Maximum opgenomen vermogen	kW	2,8	4
Maximum opgenomen stroom	A	19	28
Zekering op het net	A	16	
Nullastspanning	V	430	406
Krachtfactor	cos fi	0,6	0,7
Rendement	eta	0,8	0,85
Isolatieklasse		H	H
Beschermingsklasse	IP	23	23
Gewicht	kg	6,40	7,60
Afmetingen (l x b x h)	mm	400 x 150 x 235	450 x 150 x 270
Prijs	€	839,00	879,00

Accessoires plasma



Plasmatoorts

Order nr.	Voor type	Lengte m	Prijs €
830742239	Tecnica Plasma 34 Kompressor	4	275,00
830742237	Tecnica Plasma 31 Kompressor	4	275,00
830742381	Technology Plasma 54 Kompressor	4	275,00
830742065	Tecnica Plasma 41, Technology Plasma 41	6	289,00
830742040	Superior Plasma 60 HF	6	290,00
830722332	Superior Plasma 90 HF	6	392,00
830722333	Superior Plasma 90 HF	12	569,00
830722334	Superior Plasma 90 HF	12	735,00



Elektroden voor plasmatoorts. VE = verpakkingseenheid.

Order nr.	Omschrijving	Voor type	VE	Prijs/VE €
830802420	elektrode	31, 41, 34-54K	5	22,00
830802428	lange elektrode	31, 41	5	36,00
830802423	bek	31, 41, 54K	5	25,00
830802092	bek	34K	5	28,00
830802429	lange bek	31, 41	5	30,00



Veiligheidskapjes. VE = verpakkingseenheid.

Order nr.	Voor type	VE	Prijs/VE €
830802425	Tecnica Plasma 31,41	2	44,00
830802081	Superior Plasma 60 HF	2	33,00
830802126	Superior Plasma 90 HF	2	78,00
830802096	Tecnica Plasma 34 K	2	54,00
830802485	Tecnica Plasma 54 Kompressor	2	32,00



Diffusors voor plasmatoorts. VE = verpakkingseenheid.

Order nr.	830802422	830802080	830802123
Voor type	Tecnica Plasma 31,34K,41, Technology plasma 41, Technology 54 Kompressor	Technology Plasma 60 HF	Technology Plasma 90 HF
VE	5	2	5
Prijs/VE €	79,00	36,00	78,00

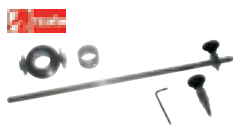

Cirkelsnijder voor plasma-snijders
Telwin 31, 41, 54K en 34K.

Order nr.	830802214
Maximum diameter	mm 680
Prijs	€ 58,00

Verbruiksartikelen



Rutel gecoate laselektrodes E6013 voor het lassen van diverse soorten ongelegeerd staal tot 38kg/mm² treksterkte. Lassen in de meeste lasposities. Gemakkelijk op starten, stabiele vlamboog en weinig spatten. Gemakkelijk verwijderbare slak. Geschikt voor industrie, handwerk en assemblage.

Treksterkte las : 48 kg/mm².

Klasse: AWS A5.1:E6013.

Order nr.	830802737	830802739	830802749
Diameter	mm 2x300	2,5x300	3,2x300
Stroomsterkte	% 40 @70A	60 @100A	80 @ 130A
Gewicht	kg 10,40	8,90	16,50
Prijs	€ 11,00	9,50	17,00



R43 rutiel beklede elektrode. Geschikt voor universeel lassen van ongelegeerd staal, ideaal bij verticaal lassen en verticaal opgaand lassen. De elektrode is zeer eenvoudig in gebruik, ook voor onervaren lassers. Prijs per pak.

- Lasroom: AC/DC
- Klasse: EN ISO 2560 A:E 42 0 RR12 en AWS A5.1:E. 6013
- Metaal uitwisseling: 95%
- C: 0.08
- Si: 0.35
- Mn: 0.5
- Maximum reksterkte R(e): 420-510 N/mm²
- Treksterkte R(m): 510-640
- Uitbreiding A(5): 22%
- Impactsterkte KV: 0% C - engt;47J.

Order nr.	Diameter mm	Lengte mm	Lasroom A	Gewicht kg	Prijs €
205930100	2	300	50-70	1,00	7,50
205930308	2,5	350	65-90	3,00	20,50
205930407	3,2	350	100-140	2,70	17,50
205930506	4,0	450	140-180	6,00	36,50



R44S rutiel beklede elektrode. Geschikt voor universeel lassen van ongelegeerd staal. Lassen in alle posities, alsook boven het hoofd en verticaal neerwaarts. Tolerant voor variërende oppervlakken, en uitstekend voor het dichtmaken van grote openingen. Prijs per pak.

- Lasroom: AC/DC-
- Klasse: EN ISO 2560 A:E 38 O RC 11 en AWS A5.1 : E 6012
- Metaal uitwisseling: 95%
- C: 0.12
- Si: 0.6
- Mn: 0.5
- Maximum reksterkte R(e): 470 N/mm²
- Treksterkte R(m): 550 N/mm²
- Uitbreiding A(5): 23%
- Impactsterkte KV: 0% C - engt; 56J.

Order nr.	205940208	205940307
Diameter	mm 2,5	3,2
Lengte	mm 350	350
Lasroom	A 70-90	95-130
Gewicht	kg 2,80	2,70
Prijs	€ 22,50	20,90



Basisch gecoate laselektrodes E7018 voor hogekwaliteitslassen met goede sterkte en hardheid. Geschikt voor diverse soorten ongelegeerd staal tot 42 kg/mm² treksterkte. Geschikt voor lassen van staal voor tanks of drukvaten, staal toegepast in hoge of lage temperatuur, onzuiver staal en staal met hoger koolstofgehalte. Voor lassen in de meeste lasposities.

Treksterkte las : 56 kg/mm².

Klasse: AWSa5.1:E7018.

Order nr.	830802748	830802765
Diameter	mm 2,5x300	3,2x350
Stroomsterkte	% 60 @110A	90 @140A
Gewicht	kg 2,50	5,10
Prijs	€ 12,00	22,50



R48S basisch beklede elektrode voor het lassen van ongelegeerd staal, Mn staal en TM staal (0,15% legeringen). Uitstekende laskenmerken, de ideale all-round laselektrode voor veeleisende toepassingen in productie, buislassen en duurzame herstelwerkzaamheden.

Lage waterstofopname (Moist resistant) voor verbeterde mechanische laseigenschappen.

- Lasroom: AC/DC+
- Klasse: EN ISO 2560-A: E 46 4 B 42 H5 en AWS A5.1:E. 7018-1 H4R
- Metaal uitwisseling: 130%
- C: 0.05
- Si: 0.3
- Mn: 1.3
- Maximum reksterkte R(e): 470 N/mm²
- Treksterkte R(m): 570
- Uitbreiding A(5): 27%
- Impactsterkte KV: -40% C - engt; 103.

Order nr.	Diameter mm	Lengte mm	Lasroom A	Gewicht kg	Prijs €
205960107	2.0	300	50-80	1,00	17,20
205960305	2.5	350	80-110	2,50	19,70
205960404	3.2	450	95-150	5,70	38,30
205960503	4.0	450	125-210	6,00	38,20



RMA MIX 18 Rutiel inox elektrode met 6% Mn legering geschikt voor lassen in 13% Mn staal, gehard staal en andere types staal die moeilijk te lassen zijn. Ook geschikt om getemperd staal en inox te verlassen zonder vooraf te verhitten.

Hardheid van de las: van 200 HV tot 450HV.

Toepassingen: buffer lagen onder de bovenste laag van RMA H100 op de plaat van verbrijzelaars en zware werfmachines, rails, rail wissels, treinwielen en kraanwielen van Mn staal. Geleverd in pvc doos.

- Lasroom: AC/DC+
- Klasse: EN1600: E18 8 Mn R53 en AWS A 5.4 :E: 307 - 26
- Metaal uitwisseling: 95%
- Maximum reksterkte R(p) 0.2%: 425 N/mm²
- Treksterkte R(m): 650 N/mm²
- Uitbreiding: 35%

Order nr.	206240103	206240202
Diameter	mm 2,5	3,2
Lengte	mm 350	350
Lasroom	A 80-100	110-150
Gewicht	kg 1,00	1,00
Prijs	€ 33,00	26,90



Universele lasdraad op kleine rol voor staal. De bobijnen worden gemonteerd met de adapter 830990703.

Order nr.	Diameter mm	Haspel diameter mm	Gewicht kg	Prijs €
830802132	0,6	100	0,83	9,00
830802395	0,6	200	5,25	44,00
830802133	0,8	100	0,85	8,00
830802396	0,8	200	5,39	37,00



RM70 Met koper omhulde silicium/mangaan gelegerde lasdraad voor MIG lassen van niet-gelegerde en gezandstraalde staaltypes. Geproduceerd met de modernste machines en met de grootste zorg voor kwaliteit om een optimaal lasproces te kunnen garanderen. Volgens de volgende normen EN 440 G3Si1 en AWS A5.18 ER 70 S-6. Maximum rekvermogen Re 420 N/mm². Maximum trekvermogen Rm 520 N/mm². Lasstroom:DC+. Prijs per rol.

Order nr.	Diameter mm	Haspel diameter mm	Gewicht kg	Prijs €
206030306	0,8	200	5,00	30,50
206030405	0,8	300	15,00	64,50
206030504	1	300	15,00	55,90
206030603	1,2	300	15,00	59,00



Lasdraad van pure aluminium. Voor MIG lassen van niet-gelegerd aluminium van kwaliteit SS 4005 4007 4010. De las kan gemakkelijk worden behandeld en heeft goeie corrosie- en geleidingseigenschappen. OPMERKING ! Voor het lassen van aluminium moet het oppervlak grondig worden gereinigd. Volgens de volgende normen AWS A5.10- ER 1100. Maximum rekvermogen Rp 0.2% 30 N/mm². Maximum trekvermogen Rm 100N/mm². Bedrijfstemperatuur: 630 - 640° C. Lasstroom: DC+. Prijs per rol.

Order nr.	Diameter mm	Haspel diameter mm	Gewicht kg	Prijs €
206060105	0,8	300	7,00	143,00
206060204	1	300	7,00	125,00
206060303	1,2	300	7,00	109,00



Lasdraad op rol voor aluminium. Adapter voor een kleine bobijn beschikbaar: 830802486.

Order nr.	830802062	830802064
Diameter	mm 0,8	1,0
Haspel diameter	mm 100	100
Gewicht	kg 0,50	0,52
Prijs	€ 27,00	25,00



Universele lasdraad op rol voor roestvrij staal. Voor het artikel 830802051 is er een adapter voor een kleine bobijn beschikbaar: 830990703.

Order nr.	830802051	830802061
Diameter	mm 0,8	0,8
Haspel diam.	mm 100	200
Gewicht	kg 0,59	1,10
Prijs	€ 26,00	48,00



Lasdraad voor MIG lassen van RVS en Inox met laag koolstofgehalte of inox met 19CR12Ni en 2.7Mo. Kan gebruikt worden voor staal volgens norm SS 2348, 2375, 2333, 2343 en 2353. Het verhoogde silicium gehalte resulteert in excellente eigenschappen: hoge stabiliteit van de vlamboog, een constante en vlotte materiaalstroom en een kort interval van de vlamboog. Kan ook gebruikt worden voor normale koolstof Nb of Ti gestabiliseerd staal op voorwaarde dat de bedrijfstemperatuur onder de 400° C is. Prijs per rol.

- Lasstroom: DC+.
- Klasse: EN ISO 14343 G: 19 12 3 LSi en AWS A5.9 ER 316 LSi
- C: 0.015
- Si: 0.82
- Mn: 1.82
- Cr: 18.3
- Ni: 12.33
- Mo: 2.51
- Maximum reksterkte R(p) 0.2%: 400 N/mm²
- Treksterkte R(m): 600 N/mm²
- Uitbreiding A(5): 40%
- Impactsterkte KV: 20°C - 11J; -196°C - 50J
- Beschermgas: Ar+1-3%O(2) 16-20 l/min (M13)

Order nr.	206140105	206140196	206140204
Diameter mm	0,8	0,8	0,8
Haspel diameter mm	100	200	300
Prijs €	32,10	83,10	194,50



Gevulde lasdraad voor FLUX lassen (lassen zonder gas).

Order nr.	Diameter mm	Haspel diameter mm	Gewicht kg	Prijs €
830802145	1,2	100	0,89	22,00
830802146	1,2	200	3,37	78,00
830802179	0,9	100	0,89	19,00
830802181	0,8	200	3,40	95,00
830802188	0,9	200	3,26	69,00
830802208	0,8	100	0,87	22,00



Flux lasdraad. Voor het lassen van dunne materialen met een dikte van 1.0 - 5 mm en gegalvaniseerde metalen zonder gebruik van beschermingsgas. Mag in alle richtingen en posities gelast worden. Kan gelast worden met ampèrage vanaf 25 Amp, wat het risico op doorbranden van het metaal vermijdt. Geschikt voor constructie- en onderhoudswerk, Industrie en hobby, automotive en doe het zelf. Prijs per rol.

- Lasstroom: DC-.
- Klasse: AWS 5.20 E 71T-GS
- Treksterkte R(m): 520 N/mm²

Order nr.	206190100	206190209
Diameter mm	0,9	0,9
Haspel diameter mm	100	200
Gewicht kg	0,90	4,50
Prijs €	16,50	65,50



Braseerdraad op rol voor hardsolderen.

Order nr.	Materie	Diameter mm	Haspel diameter mm	Gewicht kg	Prijs €
830802495	CuSi3	0,8	100	0,95	76,00
830802434	CuSi	0,8	200	3,00	230,00
830802496	CuAL8	0,8	100	0,95	76,00
830802439	CuAL	0,8	200	3,00	230,00



Rutiel elektrode. Geschikt voor lassen van niet-gelegeerd staal. Vooral toepasbaar bij verticaal aaneenlassen en verticaal oplassen. Mag gebruikt worden voor het aaneenlassen van plaatstaal, hoeken en opstaande stukken. De elektrode is zeer eenvoudig in gebruik, ook voor onervaren lassers. Prijs per pak.

- Klasse: EN ISO 636: A-W 2 Si Material No 1.5125 en AWS A5.18: ER: 70-S-6
- C: 0.09
- Si: 0.87
- Mn: 1.47
- Maximum reksterkte R(p): 420 N/mm²
- Treksterkte R(m): 500 N/mm²
- Uitbreiding A(5): 22%
- Impactsterkte KV: -50°C - 47J
- Beschermingsgas: Argon 7-11 l/min (I1)

Order nr.	Diameter mm	Lengte mm	Gewicht kg	Prijs €
206040107	1.6	1000	5,00	46,50
206040206	2.0	1000	5,00	44,50
206040305	2.4	1000	5,00	44,50
206040404	3.0	1000	5,00	42,50

Clima



Magnesium legering aluminium elektrode. voor TIG-lassen van zeewater resistente aluminium legeringen die tot 5% Mg bevatten. RT AlMg5 is de meest gebruikte elektrode voor het lassen van aluminium. OPMERKING ! Voor het lassen van aluminium moet het oppervlak grondig worden gereinigd. Prijs per rol.

- Lasstroom: AC
- Klasse: EN 18273 S Al 5356 (AlMg5(A) en AWS A5.10-ER 5356
- Si: 0.06
- Mn: 0.13
- Al: bal.
- Mg: 5
- Fe: 0.12
- Maximum reksterkte R(p)0.2%: 120 N/mm²
- Treksterkte R(m): 255 N/mm²
- Uitbreiding A(5): 24%
- Smelttemperatuur: 560-650°C
- Beschermgas: Argon 5-10 l/min (I1) - Helium 8-6 l/min (I2) - Argon/Helium 5-10 l/min (I3)

Order nr.	Diameter mm	Lengte mm	Gewicht kg	Prijs €
206090052	1,6	1000	2,00	42,50
206090102	2,4	1000	2,00	35,50
206090201	3,2	1000	2,00	36,50
206090300	4	1000	0,10	32,90

Clima



Inox elektrode met laag koolstofgehalte voor TIG lassen van inox die 19Cr 12Ni en 2.7Mo bevat. Kan gebruikt worden op staal volgens SS 2348, 2375 (RUS), 2343 en 2353, kan ook gebruikt worden voor gewoon koolstof staal dat Nb of Ti gestabiliseerd is op voorwaarde dat de bedrijfstemperatuur onder de 400° C is. Prijs per pak.

- Lasstroom: DC
- Klasse: EN ISO 14343: W 19 12 3 LSi en AWS A5.9 ER 316 LSi
- C: 0.015
- Si: 0.82
- Mn: 1.82
- Cr: 18.3
- Ni: 12.33
- Mo: 2.51
- Maximum reksterkte R(p)0.2%: 400 N/mm²
- Treksterkte R(m): 600 N/mm²
- Uitbreiding A(5): 40%
- Impactsterkte KV: 20°C - 120J; 196°C - 50J
- Beschermgas: Ar 99,99%, 6-12 l/min (I1)

Order nr.	206150203	206150302	206150401
Diameter mm	1,6	2	2,4
Lengte mm	1000	1000	1000
Gewicht kg	5,00	5,00	5,00
Prijs €	75,50	69,50	65,00

Clima



Lastang voor elektrodelassers.

Order nr.	830802538	830802539
Ampère A	300	400
Gewicht kg	0,30	0,49
Prijs €	10,00	14,00

Clima



Aardingsklemmen.

Order nr.	830802533	830802534	830802535
Ampère A	250	400	600
Gewicht kg	0,18	0,43	0,59
Prijs €	6,00	12,00	22,00

Clima



DINSE stekker 25mm² - 2 stk.

Order nr.	830802558
Gewicht kg	0,11
Prijs €	10,00

Clima



Bikhamer.

Order nr.	830802543
Gewicht kg	0,25
Prijs €	8,00

Clima



Anti-stick spray. Voorkomt lasspatten op werkstuk en toorts. Verbetert de werkefficiëntie.

Order nr.	830722000
Gewicht kg	0,46
Prijs €	8,00

Soldeergereedschap

METALWORKS



NEW

Hetelucht pistool 2000W met 2 temperatuurstanden 350/550 °C, 8-delig. Voor o.a. het verwijderen van verf, aanbrengen van krimpfolie,... In kunststof opbergkoffer. Geleverd met reflector, sponning, reduceer-, en plat mondstuk en 3 schrapers.

Order nr.	722410001 T	
Orig. nr.	SLG2000	
Maximum temperatuur	°C	350-550
Vermogen	W	2000
Gewicht	kg	0,75
Prijs	€	36,90

METALWORKS



NEW

Lasbout voor het lichtere soldeerwerk. 230V. In blister met stand, rechte soldeerpunt en gebogen platte soldeertip.

Order nr.	722310033 T	722310034 T	722310035 T
Orig. nr.	SL025	SL060	SL100
Maximum temperatuur	°C	380	470
Vermogen	W	25	60
Gewicht	kg	0,20	0,25
Prijs	€	9,90	12,90

METALWORKS



NEW

6-delige set met soldeeraccessoires, in kunststof opbergkoffer. Bevat 10 gr tindraad, tinopneempomp, spons, lasvloeistof, pincet, draadhouder/naaldpunt.

Order nr.	722310036 T	
Orig. nr.	SLA6	
Gewicht	kg	1,00
Prijs	€	19,90

METALWORKS



NEW

Las pistool 200W met temperatuurregeling (3 standen), 6-delig. In kunststof opbergkoffer, geleverd met 1 moersleutel, 2 soldeertips, 10g lasvet, 10g lasvloeistof.

Order nr.	722310037 T	
Orig. nr.	SLP200	
Maximum temperatuur	°C	70-500
Vermogen	W	200
Gewicht	kg	1,30
Prijs	€	39,50

METALWORKS



NEW

Soldeerstation 48W met temperatuurregeling 100-450°C en display. 230V. Incl. lasbouthouder en spons.

Order nr.	722310038 T	
Orig. nr.	SLS48	
Maximum temperatuur	°C	100-450
Vermogen	W	48
Gewicht	kg	1,50
Prijs	€	59,90



METALWORKS®

De METALWORKS® lastoestellen maken gebruik van hoogperformante stroominverters. Hierdoor maken we komaf met alle nadelen van transformator-lastoestellen.

Een METALWORKS® machine geeft u veel voordelen:



Zeer Licht en compact

De pluimgewichten tot 200 Ampère bieden u een hoog werkcomfort en mobiliteit. Met een aluminium koffer komt en werkt u vlot tot in moeilijk bereikbare plaatsen.

Hoge inschakelduur

Sneller werken, en dus minder tijdverlies. De performante elektronica garandeert een lage warmteontwikkeling, waardoor de toestellen kunnen blijven werken, ook op hoge lasroom.

Perfekte lasresultaten

Hoogfrequente inverters zorgen voor een constante en stabiele vlamboog, met een perfecte inbranding en lasnaadruiterlijk als resultaat.

Door de complete en gebruiksvriendelijke totaalcontrole over de digitale lasparameters zijn deze machines inzetbaar in elke omgeving. Hot start, Anti stick and arc force maken het elektrodelassen heel eenvoudig voor elke lasser.



Energiebesparend

De processor gestuurde micro-elektronica wekt op energie-efficiënte wijze de lasstroom op.

Kunnen tegen een stootje

METALWORKS® machines zijn bestand tegen spatwater, stof en metaalstof door een printplaatcoating. de hoge schok- en crashbestendigheid, en de verzonken bedieningsknoppen maken deze machines perfect inzetbaar in de moeilijkste omstandigheden. Netstroompieken of onstabiele stroom van verlengkabels vormen geen enkel probleem.

Combinatiemachines

twijfelt u tussen MMA, MIG of TIG lassen? Elke METALWORKS® machine kan 2 of meer lasfuncties tegelijk aan, wat uw werkcomfort en tijdsbesparing aanzienlijk verhoogt. bovendien kunt u sterk besparen op de machines en op de ruimte in de werkplaats.

Design

Draagbare machines met weloverwogen, gestroomlijnd design voor het ongehinderd werken zonder tijdverlies.



Metalworks MMA lasapparaten

METALWORKS



LASHELMEN
p.314



NEW MMA

Draagbaar elektrode lastoestel met transformator. Keuzeschakelaar voor lasroom. Geschikt voor elektrodes tot 3.2 mm. Ingebouwde thermische beveiliging. Geleverd met elektrodehouder, massatang, bikhamer/borstel en kleine lashelm.

Order nr.		829650254 €
Orig. nr.		ARC160
Spanning	V	230
Inschakelduur I _{max}	A @ %	100 @ 20%
Regelbereik	A	100,150
Opgenomen vermogen 60%/maximum	kW	6.5
Nullastspanning	V	48
Capaciteit staal lasdraad	mm	2.4-3.2
Lastype		Elektroden
Gewicht	kg	16,50
Afmetingen (l x b x h)	mm	1500 x 1150 x 353
Prijs	€	129,00

METALWORKS



MMA

Draagbaar inverter lasapparaat met koelventilator voor elektrodelassen. Geschikte types elektroden : rutiel, basisch, roestvrij staal, staal, gietijzer, ... Met IGBT inverter voorzien van 'Hot start' (gemakkelijk opstarten), 'Arc Force' (gemakkelijk lassen van moeilijke elektrodes) 'Anti stick' (voorkomt kleven van de elektrode). Thermische beveiliging en beveiliging tegen schommelend voltage en overbelasting. Met complete accessoireset : elektrodehouder, aardingsklem met laskabel, laskap en bikhamer, in PVC koffer.

Order nr.		829000165 €
Orig. nr.		TEC165
Spanning	V	230
Inschakelduur (stroom @ 60%)	A	140
Inschakelduur I _{max}	A @ %	140 @ 60%
Regelbereik	A	10-160
Capaciteit elektroden	mm	1,6-4,0
Nullastspanning	V	85
Kranchfactor	cos fi	0,9
Lastype		Elektrode
Gewicht	kg	5,00
Prijs	€	219,00

METAL WORKS

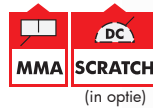

Draagbare lasinverter voor intensief elektrodelassen en LIFT TIG-DC-lassen.

Klein formaat en licht van gewicht.

IGBT-technologie met koelventilator.

Met regelbare Arc Force en Anti Stick functie voor verschillende elektrodetypes (rutil, basisch, RVS,...).

Stabiele vlamboog met minimale spatten tijdens het lassen.

Bescherming tegen overspanning en overbelasting.

Automatische correctie bij voltage-schommelingen (tot 15%).

Verlaagd risico op elektroshock door VRD functie: deze verlaagt automatisch het voltage in onbelaste toestand.

Compleet met lasaccessoires en grote alu-koffer.

Order nr.	829650170 €	
Orig. nr.	PREMIUM170	
Spanning	V	230
Inschakelduur (stroom @ 60%)	A	115
Inschakelduur I _{max}	A @ %	160 @ 30%
Regelbereik	A	10-160
Capaciteit elektroden	mm	1,6-4,0
Opgenomen vermogen 60%/maximum	kW	7,1
Kranchfactor	cos fi	0,7
Beschermingsklasse	IP	21
Lastype		Elektrode
Gewicht	kg	5,00
Afmetingen (l x b x h)	mm	313 x 120 x 198
Prijs	€	259,00

METAL WORKS

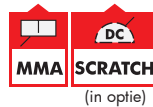

Draagbare lasinverter voor intensief elektrodelassen en LIFT TIG-DC-lassen in optie.

Klein formaat en licht van gewicht met digitaal display.

IGBT-technologie met koelventilator.

Met regelbare Arc Force en Anti Stick functie voor verschillende elektrodetypes (rutil, basisch, RVS,...).

Stabiele vlamboog met minimale spatten tijdens het lassen.

Bescherming tegen overspanning en overbelasting.

Automatische correctie bij voltage-schommelingen (tot 15%).

Verlaagd risico op elektroshock door VRD functie: deze verlaagt automatisch het voltage in onbelaste toestand.

Compleet met lasaccessoires en grote alu-koffer.

Order nr.	829650210 €	
Orig. nr.	PREMIUM210	
Spanning	V	230
Inschakelduur (stroom @ 60%)	A	145
Inschakelduur I _{max}	A @ %	200 @ 30%
Regelbereik	A	10-200
Capaciteit elektroden	mm	1,6-4,0
Opgenomen vermogen 60%/maximum	kW	9,4
Kranchfactor	cos fi	0,7
Beschermingsklasse	IP	21
Lastype		Elektrode
Gewicht	kg	8,00
Afmetingen (l x b x h)	mm	372 x 150 x 220
Prijs	€	359,00

Metalworks MIG-MAG lasapparaten

METALWORKS



MIG-MAG halfautomaat op wielen. Transformator lastoestel voor zowel MIG lassen met gas als FLUX lassen zonder gas. Stabiele vlamboog. Met lastoorts Binzel 25AK/200A met euroconnector, en gedegen draaddoorvoermecanisme. Keuzeschakelaars voor lasstroom en traploze regeling van draadsnelheid. Elektronische gasklep in de machine. Ventilatorgekoeld en met thermische bescherming. Met wielen, en door laag gewicht ook draagbaar met beugel. Geleverd met toorts 3m met euroconnectie, massatang, bikhamer/borstel, gasregelaar met 2 manometers, gasslang en kleine lashelm

Order nr.	829650249 €	
Orig. nr.		MIG200
Spanning	V	230
Inschakelduur (stroom @ 60%)	A	100
Regelbereik	A	40-200
Opgenomen vermogen 60%/maximum	kW	9,2
Nullastspanning	V	18-38
Bobijn maximum	kg/mm	15/300
Capaciteit staal lasdraad	mm	0.8-1.0
Geschikt voor lassen zonder gas		✓
Lastype		MIG/flux
Bobijn	kg/mm	15/300
Gewicht	kg	72,00
Afmetingen (l x b x h)	mm	840 x 410 x 730
Prijs	€	529,00

METALWORKS



MIG-MAG halfautomaat op wielen. Transformator lastoestel voor zowel MIG lassen met gas als FLUX lassen zonder gas. Keuzeschakelaars voor lasstroom en traploze regeling van draadsnelheid. Elektronische gasklep in de machine. Ventilatorgekoeld en met thermische bescherming. Met wielen, en door laag gewicht ook draagbaar met beugel. Geleverd met vaste toorts 2m en massatang, bikhamer/borstel, gasregelaar, gasslang en kleine lashelm.

Order nr.	829650246 €	
Orig. nr.		MIG150
Spanning	V	230
Regelbereik	A	40-140
Opgenomen stroom 60%/maximum	A	-/5.2
Nullastspanning	V	23-38
Bobijn maximum	kg/mm	5/200
Capaciteit staal lasdraad	mm	0.6-1.2
Geschikt voor lassen zonder gas		✓
Lastype		MIG/flux
Bobijn	kg/mm	5/200
Gewicht	kg	30,00
Afmetingen (l x b x h)	mm	480 x 320 x 395
Prijs	€	265,00



Multifunctioneel lastoestel geschikt voor 4 lasfuncties: elektrodelassen, MIG en TIG LIFT DC-lassen. Ook geschikt voor flux-lassen (zonder gas). Inverter met IGBT-technologie en ventilatorkoeling. Geschikt voor intensief lassen. Met Arc Force, Anti Stick, garantie voor een stabiele vlamboog. Digitaal display met manuele regeling van stroomsterkte, spanning en draaddoorvoer. Bescherming tegen overspanning en overbelasting. Verlaagd risico op elektroshock door VRD functie: deze verlaagt automatisch het voltage in onbelaste toestand. Automatische correctie bij voltage schommelingen (tot 15%). Compleet met lasaccessoires en gasontspanner met manometers.



Order nr.		829200160 €
Orig. nr.		MIG160
Spanning	V	230
Inschakelduur (stroom @ 60%)	A	120
Inschakelduur I _{max}	A @ %	160 @ 35%
Regelbereik	A	10-160
Capaciteit elektroden	mm	1,6-4,0
Nullastspanning	V	51
Krachtfactor	cos φ	0,7
Beschermingsklasse	IP	21
Bobijn maximum	kg/mm	5/200
Capaciteit staal lasdraad	mm	0,6-0,9
Capaciteit inox lasdraad	mm	0,6-0,9
Capaciteit alu lasdraad	mm	0,6-0,9
Geschikt voor lassen zonder gas		✓
Lastype		MIG+FLUX+Elektrode
Gewicht	kg	18,00
Afmetingen (l x b x h)	mm	528 x 250 x 425
Prijs	€	749,00

Metalworks TIG lasapparaten

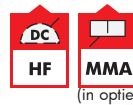

Draagbare lasinverter voor hoogfrequent (HF) DC TIG-lassen en elektrodelassen (in optie). Stevige ABS kunststofbehuizing (IP23). Deze is ook antistatisch en niet-corrosief. Hoogfrequente HF lastoorts. Regelbare POST GAZ en HF/LIFT keuzeknop. Stabiele vlamboog met goede prestaties in het lassen van staal, roestvrij staal, koper en titanium. Automatische beveiliging tegen overbelasting en overspanning. Automatische compensatie voor schommelingen van de spanning (tot 15%). Quick connect van de toorts. Compleet met lasaccessoires voor TIG-lassen en gasontspanner met manometers. TIG elektrode- en toortsaccessoires verkrijgbaar (zie volgende pagina's).



Order nr.		829300180 €
Orig. nr.		TIG180
Spanning	V	230
Regelbereik	A	10-180
Nullastspanning	V	56
Krachtfactor	cos φ	0,85
Beschermingsklasse	IP	23
Inschakelduur (stroom @ 60%)	A	160
Inschakelduur I _{max}	A @ %	140 @ 35%
Capaciteit elektroden	mm	1,6-4,0
Mobiel		✓
Lastype		TIG + Elektrode
Gewicht	kg	8,00
Afmetingen (l x b x h)	mm	400 x 150 x 260
Prijs	€	495,00



Hydraulische persen

REF: TEL: 003000

ACCESSOIRES

p.710

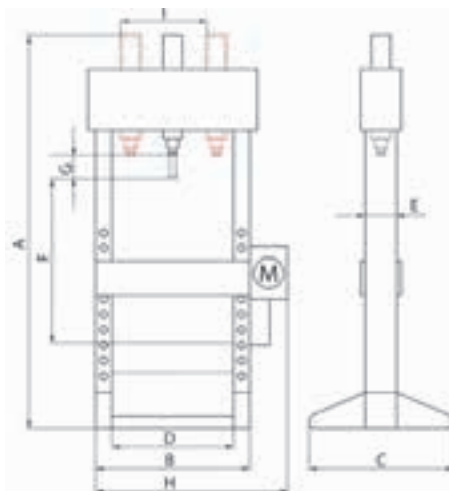

Hydraulische atelierpers. Tafelmodel. 10 ton. Ideaal voor kleine herstellingen. Met hydraulische cilinder met manometer en handpomp. Cilinder links/rechts verstelbaar. Geleverd met V-blokken. Optionele ponsenset beschikbaar.

Order nr. 754758310

Orig. nr.		CAT83010TS
Type pers		manueel
Cilinder		mobiel
Koers cilinder G	mm	160
Minimum werkstukafstand	mm	140
Benodigde luchtdruk	bar	200
Capaciteit	T	10

Afmetingen

A	mm	1064
B	mm	474
C	mm	500
D	mm	340
E	mm	110
F	mm	370
H	mm	620
I	mm	200
Gewicht	kg	60,00
Afmetingen (l x b x h)	mm	1000 x 675 x 270

Prijs € **246,00**

METALWORKS

ACCESSOIRES

p.710

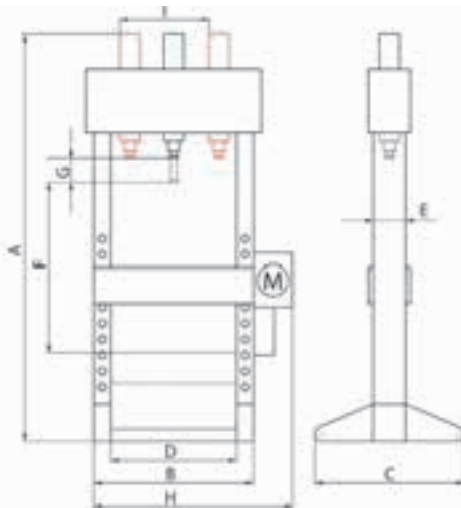

Manuele tafelpers. 15 ton. Ideaal voor het assembleren of uitrechten van kleinere werkstukken. Gelaste constructie uit 1 stuk. Bewegbare cilinder en instelbare tafelhoogte. Met manometer. Geleverd met een set V-blokken. Optionele ponsetset beschikbaar.

Order nr.		757170150 €
Orig. nr.		PH15BT
Type pers		manueel
Cilinder		mobiel
Koers cilinder G	mm	152
Minimum werkstukafstand	mm	140
Benodigde luchtdruk	bar	200
Capaciteit	T	15
Afmetingen		
A	mm	1064
B	mm	474
C	mm	500
D	mm	340
E	mm	110
F	mm	370
I	mm	200
Gewicht	kg	75,50
Afmetingen (l x b x h)	mm	1000 x 675 x 270
Prijs	€	459,00

METALWORKS

ACCESSOIRES

p.710

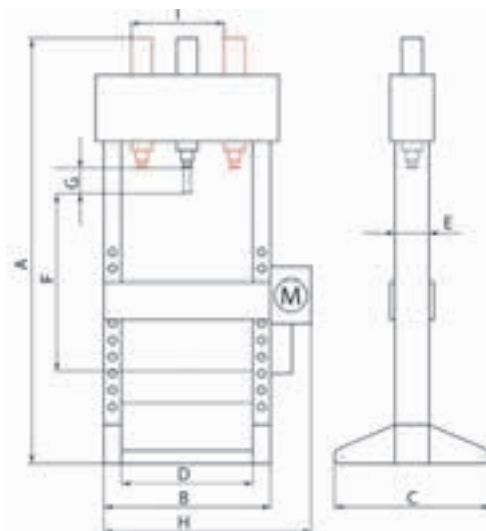

Hydraulische atelierpers. Vloermodel. Cap. 20T. Eenvoudig model met fleskrík. Voorzien van 2 veren voor terugloop van de fleskrík. Tafel verstelbaar in de hoogte. Geleverd met persblokken voor op de tafel. Gedemonteerd geleverd.

Order nr.		75475200 E
Orig. nr.		CAT520
Type pers		manueel
Cilinder		vast
Koers cilinder G	mm	150
Minimum werkstukafstand	mm	150
Capaciteit	T	20
Afmetingen		
A	mm	1570
B	mm	610
C	mm	700
D	mm	495
E	mm	90
F	mm	880
H	mm	610
Gewicht	kg	90,00
Afmetingen (l x b x h)	mm	610 x 700 x 1570
Prijs	€	229,00

METALWORKS

HYDROPNEUMATISCH

ACCESSOIRES

p.710

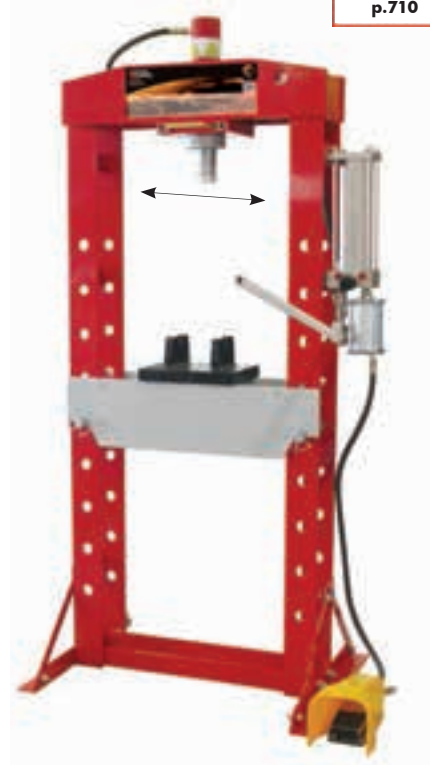
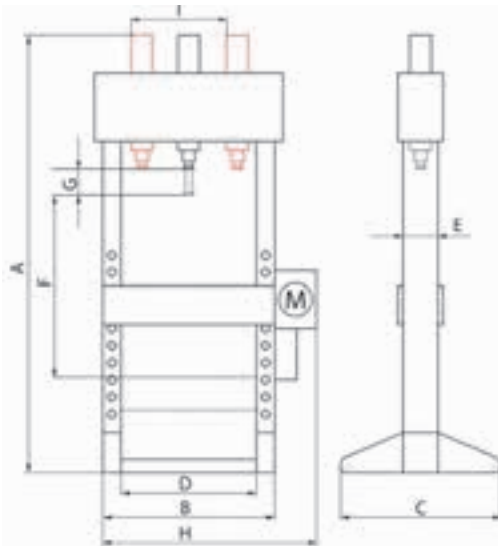

Hydraulische atelierpers met bediening via druklucht of manueel. 20 ton. Ideaal voor herhaal-toepassingen. Links-rechts verschuifbare cilinder. Bediening met manuele hendel of met voetpedaal. Robuust gelast frame. Overbelastingsventiel. Hard verchroomde as. Geleverd met manometer en 2 V-blokken. Optionele ponsset en duwbrootsen leverbaar.

Order nr.		757170220 E
Orig. nr.		PPH20B
Type pers		hydropneumatisch
Cilinder		mobiel
Koers cilinder G	mm	176
Minimum werkstukafstand	mm	45
Benodigde luchtdruk	bar	8
Capaciteit	T	20
Afmetingen		
A	mm	1619
B	mm	630
C	mm	540
D	mm	510
E	mm	132
F	mm	736
H	mm	800
I	mm	176
Gewicht	kg	151,00
Afmetingen (l x b x h)	mm	725 x 270 x 1740
Prijs	€	779,00

METALWORKS

ACCESSOIRES

HYDROPNEUMATISCH

p.710

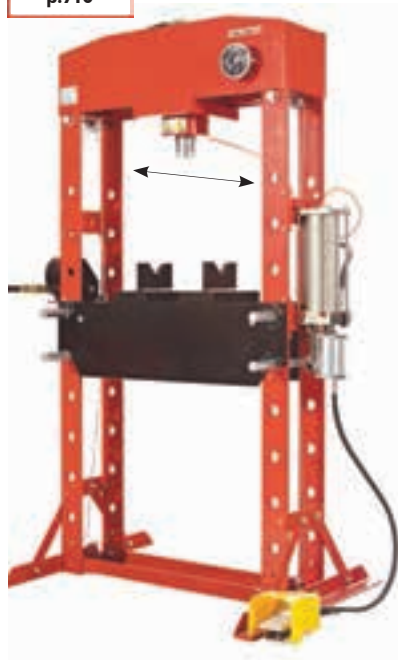

PPH50B



PPH75B

Hydraulische atelierpers. 50 ton of 75 ton. Links-rechts verschuifbare cilinder. Bediening ofwel manueel ofwel met een voet -en handbediende hydro-pneumatische pomp. Robuust gelast frame. Hydraulisch overbelastingsventiel. Verchroomde as. Geleverd met manometer en 2 V-blokken met handlier voor tafel verstelling. Optionele ponsenset en duwbrootsen leverbaar. Optionele compressor leverbaar.

PPH75B met automatische overgang tussen 2 snelheden.

NEW

Order nr.	757170520 ^E	757170075 ^E
Orig. nr.	PPH50B	PPH75B
Type pers	hydropneumatisch	hydropneumatisch
Cilinder	mobiel	mobiel
Koers cilinder G	mm	mm
Benodigde luchtdruk	bar	bar
Capaciteit	T	T
Afmetingen		
A	mm	mm
B	mm	mm
C	mm	mm
D	mm	mm
E	mm	mm
F	mm	mm
H	mm	mm
I	mm	mm
Gewicht	kg	kg
Afmetingen (l x b x h)	mm	mm
Prijs	€	€

MACHINES



WITTELWERK

NEW 100T

HYDROPNEUMATISCH

ACCESSOIRES

p.710

- Verplaatsing via hendel voor verplaatsbare kop

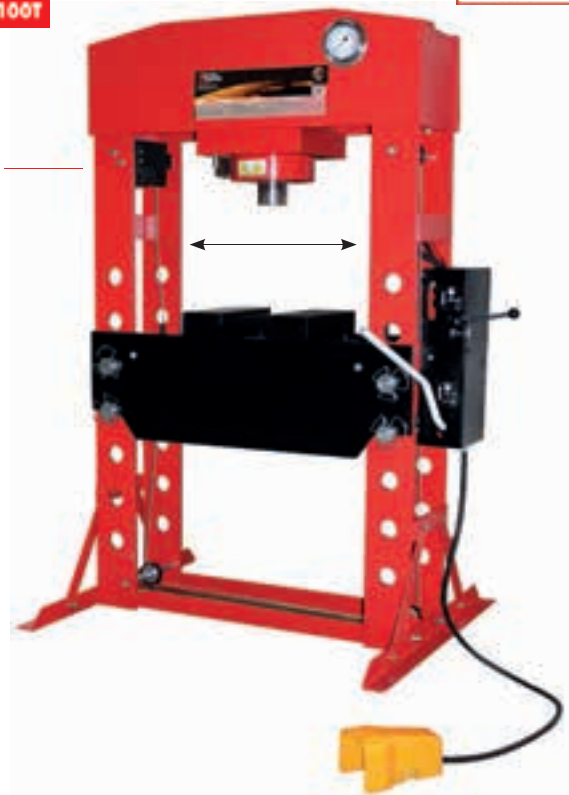
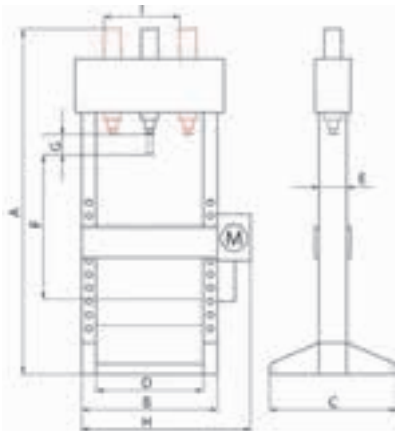

Industriële hydraulisch-pneumatische atelierpers. Capaciteit 100T. Verplaatsbare cilinder. De pompbediening is manueel of met snelle voetbediende pneumatische pomp. Automatische overgang tussen 2 snelheden (snel zakken en traag persen). Verticaal verstelbare tafel met handlier. Links/rechts verplaatsbare cilinder met hendel en spindel. Tafel met slimme positioneringsstaven. Robuust en zwaar gelast frame. Hydraulisch overbelastingsventiel. Geleverd met verzonken manometer en 2 V-blokken. Optionele ponsset en duwbroosen leverbaar. CE conform. Meer foto's op www.vynckier.biz.

Order nr.		757170100 E
Orig. nr.		PPH100B
Type pers		hydropneumatisch
Cilinder		mobiel
Koers cilinder G	mm	300
Capaciteit	T	100
Afmetingen		
A	mm	1837
B	mm	1200
C	mm	990
D	mm	787
E	mm	300
F	mm	993
I	mm	250
Gewicht	kg	766,00
Afmetingen (l x b x h)	mm	910 x 228 x 1915
Prijs	€	3.779,00

METALWORK

ACCESSOIRES

p.710

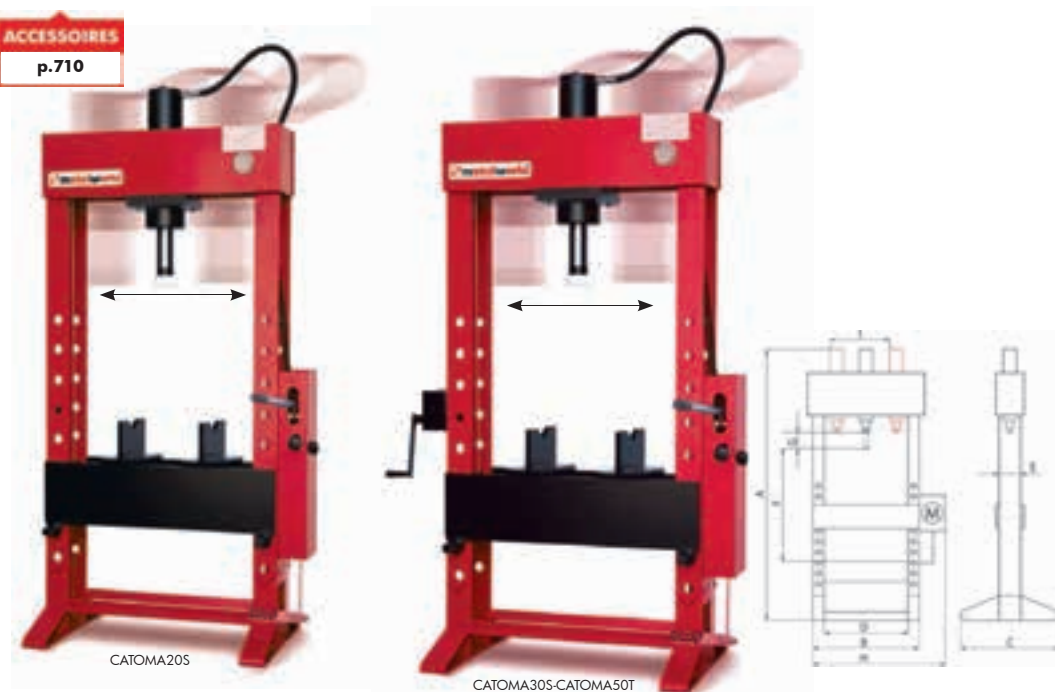

CATOMA20S

CATOMA30S-CATOMA50T

Hydraulische atelierpers. Cap. 20T, 30T of 50T. Standaard met 2-snelheden pomp. Deze pompunit kan zowel met de hand als met de voet bediend worden. De cilinder is mobiel en kan zowel naar links als naar rechts worden geplaatst. Hydraulisch overbelastingsventiel. Automatische terugkeer van de cilinder d.m.v. ingebouwde veer. Verchroomde as. Geleverd met manometer en 2 drukplaten met vlakke kant en V- aan de andere kant. Geleverd zonder olie. Uitgerust met een windas voor het opheffen van de tafel. Mechanische verbinding van beide hendels. Zie technische gegevens atelierpersen.

MACHINES

Order nr.		757172020 E	757173030 E	757175050 E
Orig. nr.		CATOMA20S	CATOMA30S	CATOMA50T
Type pers		manueel	manueel	manueel
Cilinder		mobiel	mobiel	mobiel
Koers cilinder G	mm	160	160	150
Aantal snelheden		2	2	2
Capaciteit	T	20	30	50
Afmetingen				
A	mm	1750	1920	1920
B	mm	870	990	990
C	mm	650	650	650
D	mm	690	790	790
E	mm	180	200	210
F	mm	950	1030	1015
H	mm	1010	1240	1240
Gewicht	kg	210,00	280,00	430,00
Afmetingen (l x b x h)	mm	1750 x 1010 x 650	1920 x 1400 x 650	1250 x 800 x 2280
Prijs	€	1.129,00	2.049,00	2.349,00

ACCESSOIRES

ACCESSOIRES

p.710

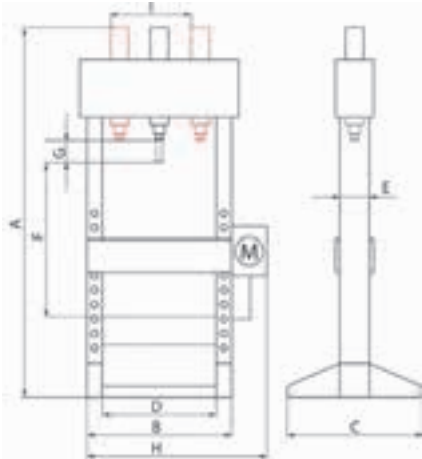

Motorische hydraulische atelierpers. 50 ton en 100 ton. Automatische 2-snelheden pomp. Zware uitvoering met vaste cilinder. Met hydraulisch overbelastingsventiel. Verchroomde as. Geleverd met manometer en 2 V-drukplaten. Geleverd zonder olie. De 50T uitvoering is uitgerust met kabellier om de druktabel mee op te heffen. De 100T met kettingensysteem om de tafel op te heffen.

Order nr.		757160505 ^E	757161010 ^E
Orig. nr.		AGMCPM50	AGMCPM100
Type pers		motorisch	motorisch
Cilinder		vast	vast
Koers cilinder G	mm	250	320
Aantal snelheden		2	2
Motor		3x230/3x400 +/- 5%	3x230/3x400 +/- 5%
Capaciteit	T	50	100
Vermogen motor	kW	1,5	1,5
Beschermingsklasse	IP	54	54
Versnelling (traag)	mm/s	1,7	1,5
Versnelling (snel)	mm/s	20	16
Afmetingen			
A	mm	2290	2280
B	mm	985	1290
C	mm	650	850
D	mm	790	1030
E	mm	210	305
F	mm	985	760
H	mm	1380	1670
Gewicht	kg	420,00	950,00
Afmetingen (l x b x h)	mm	1380 x 650 x 2290	1670 x 850 x 2280
Prijs	€	3.790,00	6.150,00



METAL WORK

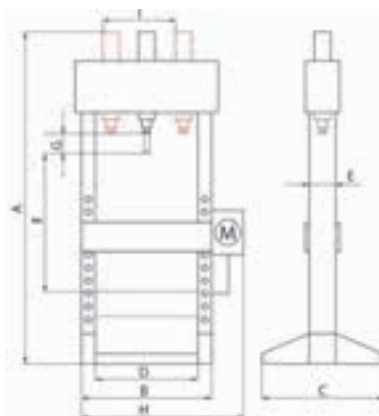

Motorische persen voor intensief en professioneel gebruik. Zware, gelaste en stabiele constructie uit 1 stuk. Cilinder garandeert hoge precisie. Motorisch of manueel werken mogelijk. Instelbare tafelhoogte met kettingen op de cilinder. Geleverd met forse tafel die werken zonder v-blokken mogelijk maakt, en manometer. De motorische op/neer beweging laat toe om gemakkelijk spiegelvenen te snijden. Optionele duwbrootsen zijn hiervoor op aanvraag.

Modellen met 2 snelheden: Bij het dalen schakelt de pomp automatisch over in lagere snelheid bij het vaststellen van tegendruk.

Met vaste of beweegbare cilinder links/rechts.

Modellen XL: extra brede uitvoering.

Geleverd zonder hydraulische olie.

Machines op maat zijn leverbaar op aanvraag.

Order nr.		75716164 [€]	75716166 [€]
Orig. nr.		PM100B2	PM100B2XL
Type pers		motorisch	motorisch
Cilinder		mobiel	mobiel
Koers cilinder G	mm	400	400
Aantal snelheden		2	2
Benodigde luchtdruk	bar	400	258
Motor		3x400	3x400
Capaciteit	T	100	100
Vermogen motor	kW	2,2	2,2
Beschermingsklasse	IP	54	54
Versnelling (traag)	mm/s	2,47	2,47
Versnelling (snel)	mm/s	7,54	7,54
Spanning	V	3x400	3x400
Oliedebiet	l/min	5,64/17,2	5,64/17,2
Inhoud olietank	l	30	30
Frequentie	Hz	50/60	50/60
Toerental	tpm	3000	3000
Diameter cilinder	mm	220	220
Diameter cilinderstang	mm	90	90
Diameter cilinderkop	mm	120	120
Afmetingen			
A	mm	2140	2140
B	mm	1350	1750
C	mm	755	755
D	mm	1100	1500
E	mm	300	300
F	mm	1665	2065
G	mm	150	150
H	mm	180	180
I	mm	750	750
Gewicht	kg	970,00	1145,00
Afmetingen (l x b x h)	mm	1665 x 780 x 2140	1665 x 755 x 2140
Prijs	€	6.000,00	8.690,00

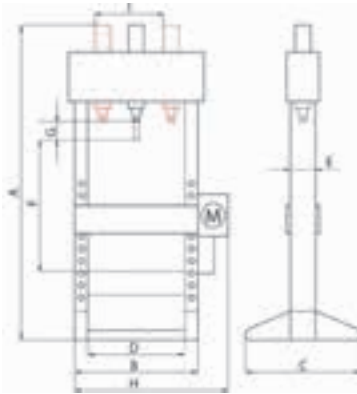

Motorische persen voor intensief en professioneel gebruik. Zware, gelaste en stabiele constructie uit 1 stuk. Cilinder garandeert hoge precisie. Motorisch of manueel werken mogelijk. Instelbare tafelhoogte met kettingen op de cilinder. Geleverd met forse tafel die werken zonder v-blokken mogelijk maakt, en manometer. De motorische op/neer beweging laat toe om gemakkelijk spieggleuven te snijden. Optionele duwbroosen zijn hiervoor op aanvraag.

Modellen met 2 snelheden: Bij het dalen schakelt de pomp automatisch over in lagere snelheid bij het vaststellen van tegendruk.

Met vaste of beweegbare cilinder links/rechts.

Modellen XL: extra brede uitvoering

Geleverd zonder hydraulische olie.

Machines op maat zijn leverbaar op aanvraag.

Order nr.		757161621	757161623
Orig. nr.		PM160B2	PM160B2XL
Type pers		motorisch	motorisch
Cilinder		mobiel	mobiel
Koers cilinder G	mm	400	400
Aantal snelheden		2	2
Benodigde luchtdruk	bar	255	255
Motor		3x400	3x400
Capaciteit	T	160	160
Vermogen motor	kW	3	3
Beschermingsklasse	IP	54	54
Versnelling (traag)	mm/s	2,4	2,4
Versnelling (snel)	mm/s	7,48	7,48
Spanning	V	3x400	3x400
Oliedebiet	l/min	8,8/27,6	8,8/27,6
Inhoud olietank	l	30	30
Frequentie	Hz	50/60	50/60
Toerental	tpm	3000	3000
Diameter cilinder	mm	280	280
Diameter cilinderstang	mm	125	125
Diameter cilinderkop	mm	160	160
Afmetingen			
A	mm	2200	2270
B	mm	1410	1810
C	mm	825	825
D	mm	1100	1500
E	mm	380	380
F	mm	1725	2125
G	mm	150	150
H	mm	180	180
I	mm	750	750
Gewicht	kg	1195,00	1430,00
Afmetingen (l x b x h)	mm	1725 x 935 x 2200	1725 x 935 x 2200
Prijs	€	8.500,00	11.500,00

METALWORKS



Set ronde duwmatrijzen voor atelierpers. 757176661 wordt geleverd zonder plaat.

Order nr.	Orig. nr.	Voor type	Diameter matrijzen mm	Prijs €
757176541 M	CATOMA20TM	CATOMA20S	5 - 10 - 14 - 18 - 24 - 29	160,00
757176561 M	CATOMA30TM	CATOMA30S	5 - 10 - 14 - 18 - 24 - 29	220,00
757176581 M	CATOMA50TM	CATO-MA50T-AG-MCPM50	5 - 10 - 14 - 18 - 24 - 29	245,00
757176661 M	V6661X100T	MCPM100-AG-MCPM150	5 - 10 - 14 - 18 - 24 - 29	120,00

METALWORKS



Set 8 ronde duwmatrijzen voor CAT83010TS, PPH20B en PPH50B. Diameters: 10, 12, 16, 18, 20, 22, 25 en 30 mm. Passen met een adapter op de cilinderkop, en laten zo toe preciezer te persen. Gewicht: 7,5kg.

Order nr.	754758311 M
Orig. nr.	CAT-SET
Prijs	€ 74,00

METALWORKS



Set V-blokken. Voor profi press persen.

Order nr.	Orig. nr.	Capaciteit T	Prijs €
757161627 M	PV30T	30	290,00
757161628 M	PV60T	60	365,00
757161629 M	PV100T	100	599,00
757161630 M	PV160T	160	760,00

METALWORKS

NEW



Met duwbrootsen maakt u in enkele bewegingen een spiegeluif in uw werkstuk. Bestemd voor gebruik op een manuele of motorische atelierpers. Bij voorkeur een machine met grote koers (bv 400mm). Kies de juiste duwbroots en geleidebus afhankelijk van de gewenste diameter van het asgat en dikte van de spiegeluif die u wilt maken.

Order nr.	Orig. nr.	Gleuf	Sleuf-breedte mm	Type	ø s gat mm	Prijs €
790008646 M	790008646	I	2	duwbroots	-	115,00
790008647 M	790008647	I	3	duwbroots	-	115,00
790008648 M	790008648	II	4	duwbroots	-	140,00
790008649 M	790008649	II	5	duwbroots	-	140,00
790008650 M	790008650	III	5	duwbroots	-	159,00
790008651 M	790008651	III	6	duwbroots	-	159,00
790008652 M	790008652	III	8	duwbroots	-	159,00
790008653 M	790008653	IV	10	duwbroots	-	236,00
790008654 M	790008654	IV	12	duwbroots	-	236,00
790008655 M	790008655	IV	14	duwbroots	-	236,00
790008656 M	790008656	V	16	duwbroots	-	389,00
790008657 M	790008657	V	18	duwbroots	-	389,00
790008658 M	790008658	VI	20	duwbroots	-	689,00
790008659 M	790008659	VI	22	duwbroots	-	689,00
790008660 M	790008660	VI	24	duwbroots	-	689,00
790008661 M	790008661	VI	25	duwbroots	-	689,00
790008662 M	790008662	I	-	geleidebus	6	27,00
790008663 M	790008663	I	-	geleidebus	7	27,00
790008664 M	790008664	I	-	geleidebus	8	27,00
790008665 M	790008665	I	-	geleidebus	9	27,00
790008666 M	790008666	I	-	geleidebus	10	27,00
790008667 M	790008667	II	-	geleidebus	11	26,00
790008668 M	790008668	II	-	geleidebus	12	26,00
790008669 M	790008669	II	-	geleidebus	13	26,00
790008670 M	790008670	II	-	geleidebus	14	26,00
790008671 M	790008671	II	-	geleidebus	15	26,00
790008672 M	790008672	II	-	geleidebus	16	26,00
790008673 M	790008673	II	-	geleidebus	17	26,00
790008674 M	790008674	II	-	geleidebus	18	26,00
790008675 M	790008675	II	-	geleidebus	19	26,00
790008676 M	790008676	III	-	geleidebus	17	31,00
790008677 M	790008677	III	-	geleidebus	18	31,00
790008678 M	790008678	III	-	geleidebus	19	31,00
790008679 M	790008679	III	-	geleidebus	20	31,00
790008680 M	790008680	III	-	geleidebus	22	31,00
790008681 M	790008681	III	-	geleidebus	24	31,00
790008682 M	790008682	III	-	geleidebus	25	31,00
790008683 M	790008683	III	-	geleidebus	26	31,00
790008684 M	790008684	III	-	geleidebus	27	36,00
790008685 M	790008685	III	-	geleidebus	28	36,00
790008686 M	790008686	III	-	geleidebus	30	36,00
790008687 M	790008687	III	-	geleidebus	32	36,00
790008688 M	790008688	III	-	geleidebus	34	36,00
790008689 M	790008689	III	-	geleidebus	35	36,00
790008690 M	790008690	III	-	geleidebus	36	36,00
790008691 M	790008691	IV	-	geleidebus	32	48,00
790008692 M	790008692	IV	-	geleidebus	34	48,00
790008693 M	790008693	IV	-	geleidebus	35	48,00
790008694 M	790008694	IV	-	geleidebus	36	48,00
790008695 M	790008695	IV	-	geleidebus	38	48,00
790008696 M	790008696	IV	-	geleidebus	40	52,00
790008697 M	790008697	IV	-	geleidebus	42	52,00
790008698 M	790008698	IV	-	geleidebus	44	52,00
790008699 M	790008699	IV	-	geleidebus	45	52,00

Knipscharen



■ Lengteaanslag



Manuele precisieplaatshaar.

- voor het snijden van metalen, papier, kunststof en andere materialen.
- Compacte maar uiterst stabiele constructie.
- Geharde staalmessen.
- Met achteraanslag en hoekaanslag.

Order nr.		713776165 ^M	713776111 ^M
Orig. nr.		TBS650	TBS1050
Achteraanslag	mm	0 - 500	0 - 500
Werkbreedte	mm	650	1050
Plaatdikte	mm	1,25	1,00
Gewicht	kg	100	160
Afmetingen (l x b x h)	mm	970 x 470 x 540	1370 x 480 x 580
Prijs	€	939,00	1.299,00

■ Contragewicht



■ Zijdelingse aanslag

■ Zware gietijzeren constructie

Universele, professionele tafelschaar voor handwerk en industrie.

- In een zware gietijzeren tafel en onderconstructie.
- Voor staalplaten (400 N/mm²) tot 1,5 mm.
- Contragewicht voor het balanceren van het bovenmes.
- Open bouwstijl
- Zijdelingse aanslag door middel van handwiel
- Uiterst stabiel.
- De standaard meegeleverde neerhouder zorgt voor een perfect snijresultaat.

Standard geleverd met:

- Verstelbare aanslag
- Hoekaanslag

Order nr.		713816001 ^M	713816002 ^M
Orig. nr.		BSS1020E	BSS1250E
Maximum plaatdikte	mm	1,5	1,5
Maximum snijbreedte	mm	1050	1250
Breedte aanslag	mm	790	790
Aanslagverstelling	mm	50-450	50-450
Achteraanslag	mm	550	550
Afmetingen tafel (b x d)	mm	1280x600	1530x600
Gewicht	kg	435	490
Afmetingen (l x b x h)	mm	2000 x 850 x 1500	2450 x 1000 x 1820
Prijs	€	2.449,00	2.645,00



METALWORKS



Manuele plaatschaar op zwaar stalen gelast frame.

- Voetbediening met pedaal van het mobiele bovenmes.
- Voorzien van twee krachtige veren
- Bovenmes onder hoek gepositioneerd voor een precieze snede

Geleverd met

- Schaalaanduiding
- Manuele achteraanslag
- Plaatneerhouders
- Transparante vingerbescherming
- 2 plaatsteunen vooraan.
- Het omkeerbaar bovenmes kan in 4 posities gemonteerd worden, voor een langdurig optimaal snijresultaat.

Order nr.	800170108 ^M	800170110 ^M
Orig. nr.	SH127015	SH245010
Maximum plaatdikte	mm 1,2	1,0
Maximum snijbreedte	mm 1270	2450
Gewicht	kg 300	500
Afmetingen (l x b x h)	mm 1600 x 750 x 1100	2750 x 750 x 1100
Prijs	€ 1.749,00	2.490,00



Gemotoriseerde plaatschaar met gemotoriseerde achteraanslag en digitale positieaanduiding.

- Robuuste machine vervaardigd uit gelaste plaatstalen constructie.
- Krachtige motor
- Hoogwaardige kwaliteitsmessen voor het snijden van staal, met 4 snijzijden
- Digitale weergave van de positie van de lengteaanslag
- Verschillende modi (3) mogelijk:
 - Een snede waarbij het bovenmes in onderste positie blijft
 - Enkelvoudige snede, bovenmes keert terug naar oorspronkelijke positie
 - Continue snede
- **Gemotoriseerde lengteaanslag** met kogelomloop spindels
- Voor het snijden van platen van diverse materialen zoals plaatstaal, roestvrij staal, aluminium, etc. (Hou rekening als u wenst roestvrij staal te knippen dat u ongeveer een 30% minder knipcapaciteit overhoudt.
- Lichtgordijn aan de achterzijde
- Vingerbescherming vooraan
- Voetpedaal bediening met aparte noodstop
- Ondersteuningsarmen met mm/inch schaalverdeling
- Dubbel, gegraveerde snijdikteinstelling, eenvoudig te verstellen door middel van een zeskantsleutel
- Uitgerust met reset knop, om na activatie van één van de vele veiligheidsmaatregelen, de machine te resetten.
- Elektrische kast met Siemens componenten, alle bedrading genummerd.
- Motorbeveiliging voor alle motoren
- Bedieningspaneel met afzonderlijke noodstop, start en stopknop
- Nederlandstalige handleiding, CE certificaat en CE kenmerk
- Nederlandstalige opschriften / veiligheidswaarschuwingen op de machine

Order nr.		800170150 ^M	800170155 ^M	800170160 ^M
Orig. nr.		MMS1250X3.5	MMS2000X3.2	MMS3050X3.2
Vermogen motor	kW	5,5	7,5	11
Spanning	V	3x400, 50Hz	3x400, 50Hz	3x400, 50Hz
Snijhoek	°	1°30'	1°30'	1°
Snijcapaciteit in staal 37	mm	3,5	3,2	3,2
Snijcapaciteit in roestvrijstaal	mm	2,5	2,2	2,2
Snijlengte	mm	1.250	2.000	3.050
Aantal slagen per minuut		47	47	47
Maximum aantal snedes per minuut		10	10	10
Lengte ondersteuningsarmen	mm	900	900	900
Lengte achteraanslag	mm	650	650	650
Hoogte werktafel	mm	800	800	800
Gewicht	kg	1440	2000	2350
Afmetingen (l x b x h)	mm	1860 x 2100 x 1180	2624 x 2100 x 1180	3600 x 2100 x 1180
Prijs	€	10.290,00	12.390,00	18.390,00

Manuele persen

OPTIMUM



Kogellagerpers.

Argumenten, die in kwaliteit, prestatie en prijs overtuigen:

- Voor het in- en uitpersen van lagers, doornen, bussen, spindels, stiften
- Stabiele constructie
- Lichaam uit hoogwaardig gietijzer
- Variabel instelbare trekstang
- 4-weg positioneerbare grondplaat
- Te bevestigen op een werkbank
- 4 verschillende uitvoeringen

Order nr.	790025111 M	790025112 M	790025113 M	713359005 M
Orig. nr.	DDP10	DDP20	DDP30	DDP5
Capaciteit	T 1	2	3	5
Uitlading	mm 95	125	150	226
Maximum werkstukhoogte	mm 123	195	310	485
Afmetingen ram (l x b x h)	mm 25x25x240	32x32x345	38x38x455	50x50x646
Handkracht (F1)	392,4 N / 40 kg - 589 N / 60 kg	392,4 N / 40 kg - 589 / 60 kg	392,4 N / 40 kg - 589 N / 60 kg	392,4 N / 40 kg - 589 N / 60 kg
Lengte hefboom (S1)	mm 340	450	600	850
Ontwikkelde kracht (F2)	7480 N / 763 kg - 11220 N / 1143 kg	8364 N / 853 kg - 12555 N / 1280 kg	7705 N / 786 kg - 11566 N / 1179 kg	10251 N / 1045 kg - 15372 N / 1567 kg
Gewicht	kg 14,00	33,00	55,00	154,00
Afmetingen (l x b x h)	mm 270 x 180 x 410	430 x 235 x 680	455 x 260 x 850	645 x 370 x 815
Prijs	€ 85,00	159,00	259,00	779,00

Metaalscharen



Plaatschaar. Voor staalplaat en assen. Geleverd met hendel en plaatneerhouder. Geschikt voor het verwerken van staal S235JR.

Order nr.	731010004 ^M	731010005 ^M	731010006 ^M
Orig. nr.	BIR1BH4	BIR1BH5	BIR1BH6
Capaciteit snijden plat	mm 4	5	6
Capaciteit snijden rond	mm 10	11	13
Afmetingen mes	mm 120	150	180
Gewicht	kg 8,00	13,50	19,80
Prijs	€ 139,00	149,00	259,00



Plaat- en profielschaar. Snijdt staalplaat, assen, T- en L-profielen. Geleverd met hendel en plaatneerhouder. Geschikt voor het verwerken van staal S235JR.

Order nr.	731024080 ^M
Orig. nr.	BIR4RP/8
Capaciteit snijden plat	mm 8
Capaciteit snijden rond	mm 16
Capaciteit T-profiel	mm 40x6
Capaciteit L-profiel	mm 40x6
Afmetingen mes boven	mm 186x80
Afmetingen mes onder	mm 170x80
Gewicht	kg 45,00
Prijs	€ 529,00



Zware plaatschaar. Snijdt staalplaat en assen. Geleverd met hendel en plaatneerhouder. Zware uitvoering.

Order nr.	731013000 ^M	731015000 ^M
Orig. nr.	BIR2BH300	BIR3BH500
Capaciteit snijden plat	mm 4	5
Capaciteit snijden rond	mm 13	13
Afmetingen mes	mm 300	500
Gewicht	kg 30,00	132,00
Prijs	€ 299,00	1.099,00



Zware plaat- en profielschaar. Snijdt staalplaat, assen, T- en L-profielen. Geleverd met hendel en plaatneerhouder. Aandrijving van het knipmechanisme gebeurt met een tand-aandrijving. Extra-zwaar model.

Geschikt voor het verwerken van staal S235JR.

Order nr.	731045010 ^M
Orig. nr.	BIR5RP/10
Capaciteit snijden plat	mm 10
Capaciteit snijden rond	mm 22
Afmetingen mes	mm 90x12
Capaciteit snijden vierkant	mm 20
Capaciteit T-profiel	mm 60x7
Capaciteit L-profiel	mm 60x7
Gewicht	kg 103,00
Prijs	€ 1.295,00

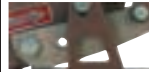

Vervangmesses voor plaatscharen en ponseenheden. Set bestaande uit boven- en ondermes.

Order nr.	Orig. nr.	Prijs €
731060120 ^M	BIR1BH4	55,00
731060121 ^M	BIR1BH5	69,00
731060122 ^M	BIR1BH6	82,00
731060123 ^M	BIR2BH300	152,00
731060117 ^M	BIR3BH500	231,00
731065010 ^M	BIR5RP/10	180,00
731064080 ^M	BIR4RP/8SET	174,00



Ponsmachine voor manueel ponsen. Geleverd met hendel. Aandrijving van het mechanisme gebeurt met een tand-aandrijving. Met verstelbare stop. Standaard geleverd met 1 set pons + matrijs 16mm.

Diverse ponsen- en matrijssets optioneel leverbaar van 4 tot 22mm alsook oude en vierkante vormen.

Order nr.	731051001 ^M
Orig. nr.	BIR5BH10
Capaciteit ponsen 12mm	mm 10
Capaciteit ponsen 16mm	mm 7
Capaciteit ponsen 18mm	mm 5
Capaciteit ponsen 20mm	mm 4
Uitlading	mm 170
Gewicht	kg 65,00
Prijs	€ 639,00



Set pons en matrijs per diameter voor ponsseenheid BIR5BH10.

Order nr.	Orig. nr.	Capaciteit mm	Prijs €
731051064	BIR5BH10-4MM	4	27,00
731051066	BIR5BH10-6MM	6	27,00
731051068	BIR5BH10-8MM	8	27,00
731051070	BIR5BH10-10MM	10	27,00
731051072	BIR5BH10-12MM	12	27,00
731051074	BIR5BH10-14MM	14	27,00
731051076	BIR5BH10-16MM	16	27,00
731051078	BIR5BH10-18MM	18	27,00
731051080	BIR5BH10-20MM	20	27,00
731051082	BIR5BH10-22MM	22	27,00



Betonijzerschaar. Met extra-lange hendel. Met tand-aandrijving van het knipmechanisme.

Order nr.	731035022	731035026
Orig. nr.	BIR50/22	BIR50/26
Capaciteit snijden plat mm	22	26
Afmetingen mes mm	35x35	50x50
Gewicht kg	25,00	37,00
Prijs	€ 198,00	481,00



Vervangmesses voor betonijzerscharen BIR50. Set bestaande uit boven- en ondermes.

Order nr.	Orig. nr.	Prijs €
731065016	BIRMES5018	30,00
731065022	BIRMES50/22	37,50
731065026	BIRMES50/26	49,00

Plooi machines

METALWORKS



Plooi toestel voor het snel plooiën van betonijzers en metaalprofielen op de werf. Geharde buigrollen met vaste radius. Plooi alle profielen (plat, rond, ...) en materialen (inox, ijzer, betonijzer...). Bij plaatsing boven elkaar, kunnen meerdere profielen tegelijk geplooid worden. Compacte montage op werkbank door afneembare hendel.

Order nr.	757491055
Orig. nr.	CAT10055
Type plooiën	profiel
Bediening	manueel
Maximum plooihoek	° 180
Plat staal	mm 30x5
Capaciteit rondstaal	mm 12
Inox	✓
Betonstaal	✓
Staal	✓
Voor werkbank	✓
Gewicht	kg 7,00
Prijs	€ 79,00

METALWORKS



Universeel plooi toestel voor het plooiën van metaalprofielen. Solide gietijzeren constructie. Geleverd met hoekaanduiding, aanslag en snelspanklem. Plooi alle profielen (plat, rond, ...) en materialen (inox, ijzer, betonijzer...). Bij plaatsing boven elkaar, kunnen meerdere profielen tegelijk geplooid worden. Compacte montage op werkbank door afneembare hendel. Met een set matrijzen (voor verschillende bochtdiameters en profielen). Plooihoek tot 120° met fijnafstelling. Geleverd met aanslag voor repetitief werk.

Order nr.	757491070
Orig. nr.	CAT10070
Type plooiën	profiel
Bediening	manueel
Maximum plooihoek	° 120
Plat staal	mm 100x15
Capaciteit vierkant staal	mm 30
Capaciteit betonstaal	mm 30
Inox	✓
Betonstaal	✓
Staal	✓
Voor werkbank	✓
Gewicht	kg 33,00
Prijs	€ 246,00

METALWORKS



Draagbaar plooi toestel. Voor lichte buizen, zoals koper gegloeid staal en messing. Draagbaar en klaar voor gebruik, ingebouwde klem voor montage op de werktafel. Bevat een set van 4 matrijzen. Biedt ook mogelijkheid om materiaal te klemmen voor het zagen van stukken op maat. Geschikt voor assembleren van hydraulische verbindingen, voor loodgieters, garagisten enz.

Order nr.	757491040	
Orig. nr.	1040	
Type plooiën	profiel	
Type	1040	
Set matrijzen voor het plooiën van buizen	mm	5-6 (radius 31) 8 (radius 33) 10 (radius 40) 12 (radius 40)
Maximum hoek van de bocht	°	180
Maximum wanddikte van het staal	mm	1
Andere materialen	mm	1,5
Gewicht	kg	7,00
Prijs	€	190,00

METALWORKS



Universeel plooi toestel op voet. Gelaste staalplaatconstructie. Plooi alle vormen van plat en rond materiaal (handvaten, u-ringen, ronde haken, enz...) via een meerrollende hefboom. Geleverd met 8 matrijzen voor plat materiaal.

Order nr.	757491090	
Orig. nr.	CAT10090V	
Type plooiën	profiel	
Bediening	manueel	
Plat staal	mm	8x30 - 6x50
Capaciteit rondstaal	mm	16
Capaciteit vierkant staal	mm	16x16
Capaciteit betonstaal	mm	12
Matrijzen plat staal	8	
Inox	✓	
Staal	✓	
Gewicht	kg	26,00
Prijs	€	129,00

METALWORKS



CAT10090VACC. Vervangset van 8 matrijzen voor plat materiaal voor plooi machine CAT10090V.

Order nr.	757491099	
Orig. nr.	CAT10090VACC	
Prijs	€	56,00

metalcraft



Universeel plooi toestel voor het plooiën van platte, rechthoekige en ronde vormen. "Made in EU".

- Met dit toestel is het zowel mogelijk om eenvoudige als complexe vormen te buigen evenals verscheidene gesloten vormen in koud metaal.
- Voor het koud buigen tot een hoek van 180°
- Instelbare plooihoek aanslag voor een hoge herhaalnauwkeurigheid
- Uittrekbare hendel om een hogere hefkracht te genereren.
- Met het optionele buigelement UB11, kunnen ook spiralen geplooid worden, 71379011, hierdoor kan men decoratieve leuning, tuinmeubelen en decoratieve stukken maken voor binnen- en buitenshuis.
- Draagbaar en licht, ideaal voor in de werkplaats, op montage en in de servicewagen.
- Afnembaar buigelement, met optionele klemplaat, 713790004, kan deze ook op een bankschroef worden gemonteerd.
- Optionele plooirollen te verkrijgen. Met Set 10-180 tot max. ø 200 mm, 713790002.

Geleverd met

- 2 stel geharde plooirollen x ø 24/30/37/43/49/62/75 mm.
- Onderstel
- Buigeenheid

Order nr.	757491011	
Orig. nr.	UB10	
Type plooiën	profiel	
Bediening	hand	
Maximum plooihoek	°	180
Plat staal - rondbuigen	mm	10x50
Plat - scherp buigen	mm	6x50
Capaciteit rondstaal	mm	16
Capaciteit vierkant staal	mm	16x16
Inox	✓	
Staal	✓	
Gewicht	kg	32,00
Prijs	€	429,00



metall-wafl



Accessoire 011 - spiralen voor plooi machine UB10.

Order nr.	757491012
Orig. nr.	3790011
Prijs	€ 48,00

metall-wafl



Matrijzen voor plooi machine UB10. Voor het koud plooiën van verwarmings- en installatiebuizen G 3/8", G 1/2", G 3/4". De matrijzen worden verkocht per paar, u heeft steeds 1 grote en 1 kleine matrijs nodig per afmeting.

Order nr.	757491015
Orig. nr.	3790001
Matrijs 3/8" (extern 16,7 - 17,7mm)	mm 102
Matrijs 1/2" (extern 21 - 22mm)	mm 108
Matrijs 3/4" (extern 26,5 - 27,5mm)	mm 112
Prijs	€ 155,00

metall-wafl



Matrijzen voor plooi machine UB10. Voor het overhoeks plooiën met een max. breedte tot 50 mm en een max. dikte van 7 mm en voor het plooiën van rechthoekig staal tot 16 x 16 mm. Deze set is geschikt voor decoratieve smederij, maar ook voor algemeen smeedwerk. Bestaat uit 4 sets matrijzen.

Order nr.	757491018
Orig. nr.	3790002
Aantal matrijzen	8
Diameter	mm 110 - 150 - 175 - 200
Prijs	€ 259,00

metall-wafl



Ombouwkit voor dunwandige buizen voor UB10. Laat toe om dunwandige buizen te plooiën zonder knikken. Set bevat per maat de buigmal, de geleiding voor de hefboom en het hoekstuk. De kit kan eenvoudig worden gemonteerd op een bestaand plooi toestel type UB10. Bevat 6 sets: ø 14, 16, 18, 20, 22 en 25 mm. Op aanvraag andere diameters leverbaar.

Order nr.	713790006
Orig. nr.	3790006
Prijs	€ 689,00

metall-wafl



Plooi toestel voor het koud buigen van dunwandige buizen uit staal, koper, messing, en andere materialen. "Made in EU".

- Eenvoudig koud buigen van dunwandige buizen ook zonder ondersteuningselementen.
- Buigen van eenvoudige en complexe vormen.
- Verlengbare hefboom om een grotere krachten te kunnen genereren.
- Gemakkelijk en snel buigen zonder vervorming, door dubbele matrijs
- Eenvoudig vervoerbaar, ideaal voor de werkplaats, op montage en in de servicewagen.
- Afnembaar buigapparaat, waardoor deze op een bankschroef kan gemonteerd worden mits het gebruiken van de optionele klemplaat
- Groot aantal optionele matrijzen beschikbaar in diameters 6 tot 25mm
- Ook geschikt voor inox tot max. ø 22 x 2 mm.

Standaard geleverd met:

- 6 buigsegmenten (4 x diameter)

Grootte	Radius
ø14	56 mm
ø16	64 mm
ø18	72 mm
ø20	80 mm
ø22	88 mm
ø25	100 mm

(geleidingsstuk en houder)

- Onderstel

Order nr.	713776030
Orig. nr.	RB30
Maximum plooidiameter staal	mm 25x2
Gewicht	kg 48,00
Prijs	€ 995,00



Strek- en buigmachine voor de werkplaats en bouwplaats .

- Voor het vormen van velgen, kaders, vensterkaders, lijsten, carrosserie-onderdelen, ...
- Om afgeronde plaatmaterialen te rechte(n) of te zetten.
- Snel, mooi en geruisloos werken zonder verhitting.
- Strek- en buigbekken inbegrepen.
- Snel wisselen van de bekken.
- Hefboom zorgt voor de krachtoverbrenging.

Order nr.			713776102 M
Orig. nr.			SSG12
Maximum plaatdikte	mm		1,2
Uitlading	mm		25
Gewicht	kg		5,50
Afmetingen (l x b x h)	mm		150 x 50 x 140
Prijs	€		189,00



Strek- en buigmachine met voetpedaal bediening voor de werk- en bouwplaats.

- Voor het vormen van velgen, kaders, vensterkaders, lijsten, carrosserie-onderdelen, ...
- Uitgerust **met voetpedaalbediening** om extra kracht bij te zetten
- Om afgeronde plaatmaterialen te rechte(n) of te zetten.
- Voetpedaal zorgt voor de krachtoverbrenging.
- Snel, mooi en geruisloos werken zonder verhitting.
- Snel wisselen van de bekken.
- Met wielen voor eenvoudig transport

Geleverd met:

- Strek- en buigbekken
- Grondapparaat op wielen

Order nr.			713776103 M
Orig. nr.			SSG16
Maximum plaatdikte	mm		1,5
Uitlading	mm		153
Gewicht	kg		36,00
Afmetingen (l x b x h)	mm		1175 x 410 x 920
Prijs	€		1.119,00

METALWORKS



Hydraulische buizenplooiër cap 12T. Met manuele pomp. Geleverd met 6 matrijzen 1/2", 3/4", 1", 1 1/4", 1 1/2", 2" (binnenmaat). Opmerking: Niet geschikt voor dunwandige buizen of vol materiaal.

Order nr.	757502212 €		
Orig. nr.	CAT2212		
Type plooiën	profiel		
Inox	✓		
Staal	✓		
Koers pomp	mm	232	
Matrijzen (geschikte wanddikte)		1/2" (2,75mm), 3/4" (2,75mm), 1" (3,25mm), 1 1/4" (3,25mm), 1 1/2" (3,5mm), 2" (3,5mm)	
Asgat	mm	20	
Gewicht	kg	45,00	
Prijs	€	174,00	

METALWORKS



Vervangmatrijzen voor buizenplooiër CAT2212 en CAT2216. 757501507 en 757510508 zijn enkel voor CAT2216 geschikt.

Order nr.	Orig. nr.	Maat inch	Prijs €
757501001 €	CAT2212/12	1/2	16,00
757501102 €	CAT2212/19	3/4	16,00
757501203 €	CAT2212/25	1	20,00
757501304 €	CAT2212/30	1 1/4	23,00
757501405 €	CAT2212/38	1 1/2	31,00
757501506 €	CAT2212/50	2	36,00
757501507 €	CAT2212/212	2 1/2	40,00
757501508 €	CAT2212/3	3	42,00

METALWORKS



Hydraulische buizenplooiër cap 16T. Met manuele, snelle bediening dmv compressor en luchtpomp of handbediening. Geleverd met 8 matrijzen 1/2", 3/4", 1", 1 1/4", 1 1/2", 2", 2 1/2", 3". Opmerking: Niet geschikt voor dunwandige buizen of vol materiaal.

Order nr.	757502216 €		
Orig. nr.	CAT2216P		
Type plooiën	profiel		
Inox	✓		
Staal	✓		
Matrijzen (geschikte wanddikte)		1/2" (2,75mm), 3/4" (2,75mm), 1" (3,25mm), 1 1/4" (3,25mm), 1 1/2" (3,5mm), 2" (3,5mm), 2 1/2" (3,75mm), 3" (4mm)	
Asgat	mm	20	
Luchtverbruik	l/m	100-150	
Gewicht	kg	40,00	
Prijs	€	328,00	



■ Tot 2"

■ 10 ton

■ Incl. buigmatrijzen

Hydraulische buizenplooiër HRB10 met 6 buigsegmenten van 1/2" tot 2".

- Buigbereik 1/2 - 2 Inch
- Krachtig toestel met een 10 Ton hydraulische pomp.
- Voor horizontaal gebruik
- Met opklapbare pomparm
- **Inclusief 6 buigmatrijzen** van 1/2 - 3/4 - 1 - 1 1/4 - 1 1/2 - 2 Inch
- Ideaal gas-, water, damp, ... buizen uit staal, koper, composiet, ...
- Geleverd met onderstel
- Buigsegmenten zijn eveneens apart leverbaar 1/2", 713777011, tot en met 2", 713777016.

Order nr.		713777010
Orig. nr.		HRB10
Drukkracht	T	10
Gewicht	kg	48,00
Prijs	€	439,00

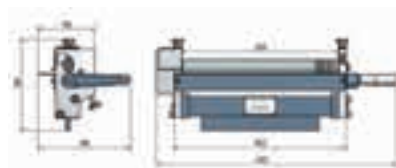

Mobiele rolmachine voor montage op vb. bankschroef. Met 3 walsen. Regelschroeven voor materiaalsterkte. Geslepen buigrollen. Buigen en rollen van draad, buizen en platen diam 1 - 2 - 3 - 4 - 5mm. Bankschroef niet inbegrepen.

Order nr.		713244030
Orig. nr.		BM3
Diameter rollen	mm	30
Type plooiën		plaat
Maximum materiaalbreedte	mm	310
Minimum buigdiameter	mm	35
Maximum buigdiameter	mm	onbegrensd
Capaciteit buigen plaatstaal St.37	mm	1
Capaciteit buigen inox	mm	1
Capaciteit buigen alu/koper	mm	2
Capaciteit buigen messing	mm	1
Capaciteit buigen goud/zilver	mm	2
Capaciteit buigen buizen	mm	1-5
Gewicht	kg	10,00
Afmetingen (l x b x h)	mm	440 x 260 x 150
Prijs	€	159,00

OPTIMUM



Mobiel zetbankje. Universeel inzetbaar. Zetbankje voor het buigen en plooiën van platen met uitneembare segmenten 150/75/50/25mm. Gemakkelijke draaibeweging van de plooirollen boven de hendelgreep. Voor gebruik op bvb bankschroef, bankschroef niet inbegrepen.

Order nr.	713244028 M	
Orig. nr.	FP30	
Type plooiën	plaat	
Maximum materiaalbreedte	mm	320
Maximum plaatdikte	mm	2,5
Maximum capaciteit rollen alu/koper	mm	300x2
Capaciteit plaatstaal	mm	300x1
Gewicht	kg	10,00
Afmetingen (l x b x h)	mm	440 x 220 x 90
Prijs	€	139,00

OPTIMUM



Universele plaatbewerkingsmachine 3 in 1. Buigen, Plooiën en snijden.

- Moderne bouwvorm in stabiele staalconstructie.
- Ideaal voor de doe-het-zelver.
- Grote ontwerpflexibiliteit door gesegmenteerde plooirollen
- Uitneembare segmentstukken in het plooirollen 40/50/65/100/180/255/380 mm voor het plooiën van bakjes.
- De bediening gebeurt via 2 zijdelings aangebrachte hendels.
- Uittrekbare steunarm voor het veilig ondersteunen van grote platen.
- Schaartafel met ingewerkte maatbanden en een rechthoekige aanslag aan beide zijden.
- Boven- en ondermes uit kwaliteitsstaal garanderen een zuiver en braamvrij snijden.
- Eenvoudig te verstellen boven, onder en achterwals.
- Grote en verstelbare hefarm
- Optioneel onderstel 713242107.

Standaard geleverd met:

- Geslepen messen, Plooirollen met segmenten, Verstelbare aanslag (achter), Materiaalsteun vooraan.

Order nr.	713242100 M	
Orig. nr.	SAR1000	
Materiaalbreedte	mm	700
Capaciteit diameter rollen minimum	mm	48
Diameter rollen	mm	48
Capaciteit rollen	mm	1
Capaciteit plooiën	mm	1
Capaciteit snijden	mm	1
Type plooiën	plaat	
Gewicht	kg	290,00
Afmetingen (l x b x h)	mm	1444 x 570 x 835
Prijs	€	1.779,00

Zmetallwatt

Klein handbediend plooi toestel voor standaard plooiopdrachten.

- Uitstekend inzetbaar voor het vervaardigen van kleine profielen, bvb. omranding van kasten.
- Instapmodel ideaal voor de doe-het-zelver of modelbouwer.
- Eenvoudig design en solide constructie.
- Gegarandeerd spannen van de plaat door kleminrichting.
- Vluggе, gebruiksvriendelijke instelling van de bovenbalk over een excenter.
- Zwenkbeweging van de plooi balk gebeurt door middel van het handvat.
- Het bovenmes is hoog geplaatst voor het plooiën van hogere U-vormen.
- Het bovenmes is opgedeeld in 5 segmenten van 25/50/75/205/255mm en met mogelijke verstelling van de te plooiën plaatdikte.
- Uitlading van 25 mm.



Order nr.		713770610 M
Orig. nr.		HSBM610HS
Type plooiën		plaat
Bediening		hand
Maximum plooi breedte	mm	610
Maximum plooi dikte staal	mm	1
Maximum plooi hoek	°	135
Staal		✓
Gewicht	kg	42,00
Afmetingen (l x b x h)	mm	850 x 360 x 420
Prijs	€	379,00

Zmetallwatt

Handbediend plooi toestel. "Made in EU".

- Licht en verplaatsbaar.
- Ideaal voor gebruik op werven.
- Hoogwaardige uitvoering en praktisch design.
- Het werkstuk kan perfect worden geklemd dankzij de speciale voorspanning van het bovenmes.
- Eenvoudige instelling van de plooihoek waardoor een goede herhalingsnauwkeurigheid kan worden bereikt.
- Zelfsmerende glijlagers.
- Gemakkelijk transporteerbaar.
- Ook beschikbaar in lengtes 660 en 1300 mm (HSBM660N en HSBM1300N).
- De bovenbalk van dit toestel kan worden uitgerust met andere balken:
 - Type N: standaard, lage bovenbalk, doorlaat 25 mm
 - Type H: optioneel, verhoogde bovenbalk, doorlaat 95 mm
 - Type HS: optioneel, verhoogde, gesegmenteerde bovenbalk.
 - Type HSG: optioneel, verhoogde gesegmenteerde bovenbalk met voetje, perfect voor de dakdekker.
- Optioneel beschikbaar achteraanslag, rolschaar, scherpe plooi messen, rond plooi messen.



Order nr.		713771050 M
Orig. nr.		HSBM1050N
Type plooiën		plaat
Bediening		hand
Maximum plooi breedte	mm	1050
Maximum plooi dikte staal	mm	1,25
Maximum plooi hoek	°	135
Inox		✓
Staal		✓
Gewicht	kg	71,00
Afmetingen (l x b x h)	mm	1348 x 850 x 1175
Prijs	€	1.190,00



metallkraft



■ Plooiën en rolschaar 2 in 1



Manuele zinkplooiemachine, ideaal voor de dakdekker op montage. "Made in EU".

- 2 machines in 1: hand plooiemachine en rolschaar.
- Ideaal voor de dakdekker op montage.
- Bvb. voor het aanmaken van hoekbuigingen, schoorsteenbekledingen, etc.
- Afneembare rolschaar, maakt het precisie snijden van koper- en zinkplaat mogelijk.
- Optioneel met kraalfunctie te verkrijgen, voor het plooiën van kralen, 713799002.
- Plooiëfunctie met garandeerde klemming van het werkstuk door voorspanning van de bovenbalk.
- Licht vervoerbaar, maar 120 kg.
- Stabiele constructie
- Hoekinstelling mogelijk van 0° tot 145°
- Rolschaar is uitgerust met een handvat om eenvoudig het apparaat te verplaatsen langs de plaat.
- Ook verkrijgbaar in 3.000 mm, HSBM3000-0.6, 713779300.

Order nr.		71379200
Orig. nr.		HSBM2200
Capaciteit plooiën	mm	2200
Maximum plooihoek	°	145
Maximum dikte staal	mm	0,7
Gewicht	kg	120,00
Afmetingen (l x b x h)	mm	2380 x 1050 x 1050
Prijs	€	2.390,00



FSBM1270-20E

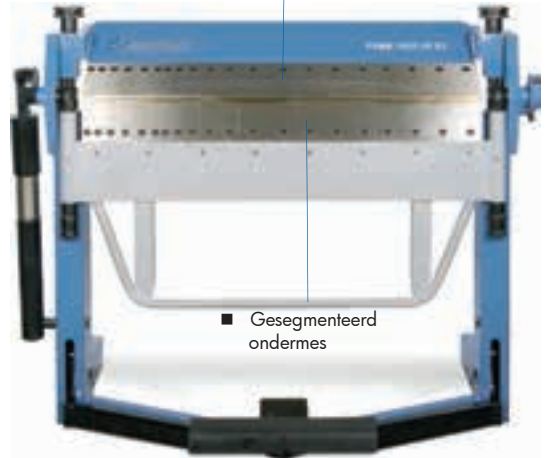

FSBM1020-20HS2

Type	Segmenten / Segments
FSBM 1020-20HS2	25 - 30 - 35 - 40 - 45 - 50 - 75 - 100 - 150 - 200 - 270
FSBM 1020-25 E	25 - 30 - 35 - 40 - 45 - 50 - 75 - 100 - 150 - 200 - 270
FSBM 1270-20 E	25 - 30 - 35 - 40 - 45 - 50 - 75 - 100 - 150 - 200 - 250 - 270



Hand -en voetbediende ploimachine.

- Universeel inzetbaar voor industrie en ambachtswerk.
- Sterke uitvoering en compact design.
- Met gesegmenteerd bovenmes.
- Model FSBM1020-20 HS2 ook met ondersegmenten.
- Het aanspannen van het werkstuk gebeurt met de voet, beide handen blijven vrij.
- Met krachtige hulpveer.

Segmentindeling:

FSBM1020-20 HS2	25-30-35-40-45-50-75-100-150-200-270
FSBM1020-25E	25-30-35-40-45-50-75-100-150-200-270
FSBM1270-20E	25-30-35-40-45-50-75-100-150-200-250-270

Order nr.		713770102 ^M	713770125 ^M	713770127 ^M
Orig. nr.		FSBM1020-20HS2	FSBM1020-25E	FSBM1270-20E
Type plooiën		plaat	plaat	plaat
Bediening		hand en voet	hand en voet	hand en voet
Maximum plooi breedte	mm	1020	1020	1270
Maximum plooidikte staal	mm	2	2,5	2
Maximum plooihoek	°	135	135	135
Inox		✓	✓	✓
Staal		✓	✓	✓
Gewicht	kg	300,00	285,00	315,00
Afmetingen (l x b x h)	mm	1348 x 850 x 1175	1348 x 850 x 1175	1710 x 710 x 1310
Prijs	€	1.890,00	1.590,00	1.890,00

metall-wafl



speciale plooivormen

Magnetische plooi bank.

- voor plaatmaterialen zoals staal, alu, inox, koper, zink, lood, ...
- Werking: het bovenmes klemt het werkstuk vast op de machinevoet via een **sterke elektromagneet**.
- Eenvoudig en snelle werkstukwissel en bediening.
- Plooit hoeken tot 170°.
- Perfecte klemming met een zuiver plooiresultaat tot in de hoeken.
- Bovenmes gesegmenteerd: 25 - 40 - 50 - 70 - 140 - 280 - 700 - 1250 mm

Unieke voordelen van deze machine:

- Extreem lage werkstukhoogte mogelijk (bovenmes is slechts 15 mm hoog)
- Uiterst snelle en eenvoudige messenwissel door magneet.
- Mee vastklemmen van diverse buigmallen is mogelijk (rond, of driehoeken bvb)

Geleverd met:

- Hoekaanslag
- Achteraanslag
- 7-delig standaard bovenmes
- Breed en smal bovenmes voor scherpe hoeken
- Gegleufd bovemes
- Opbergvak voor messen
- Voetpedaal voor bediening van de magneet.



Opgepast : machine kan pacemakers beïnvloeden.

Order nr.		713770126
Orig. nr.		MBM1250
Type plooiën		plaat
Maximum plooi breedte	mm	1250
Capaciteit buigen inox	mm	1
Plooi capaciteit	T	6
Maximum dikte staal	mm	1,6
Gewicht	kg	150,00
Afmetingen (l x b x h)	mm	1400 x 410 x 390
Prijs	€	3.120,00

METALWORKS



ZB20-1020S



Hand- en voetbediende plooiemachine.

- Geschikt voor het plooiën van alle plaatmaterialen zoals staal, koper, alu, kunststofplaat,...
- Alle modellen met gesegmenteerd regelbaar bovenmes.
- De ZB20-1020S heeft naast een segmenteerd bovenmes ook een gesegmenteerd ondermes.
- Het aanspannen van het werkstuk gebeurt met de voet, beide handen blijven vrij.
- Met krachtige hulpveer.
- Gegraveerde plooihoekinstelling, eenvoudig instelbaar
- Voorzien van smeernippels
- Geslepen boven- en ondermes
- Solide en stabiele constructie

Order nr.		800170250 ^M	800170251 ^M	800170260 ^M
Orig. nr.		ZB20-1020	ZB20-1020S	ZB20-1260
Type plooiën		plaat	plaat	plaat
Bediening		hand en voet	hand en voet	hand en voet
Maximum plooi breedte	mm	1020	1020	1260
Maximum plooidikte staal	mm	2	2	2
Maximum plooihoek	°	138	138	138
Inox		✓	✓	✓
Staal		✓	✓	✓
Gewicht	kg	300,00	300,00	300,00
Afmetingen (l x b x h)	mm	1200 x 950 x 140	1348 x 850 x 1175	1598 x 900 x 1165
Prijs	€	1.490,00	1.690,00	1.790,00

Profielbuigmachines

Frentalwerk



PRM10E

PRM10M

Profielwalsmachine met manuele PRM10M of gemotoriseerde bediening PRM10E.

- Tandwieloverbrenging
- Voor het walsen van vierkantmateriaal
- Stabiele constructie en kan aan de grond vastgemaakt worden.
- PRM10M: twee onderste walzen worden aangedreven door middel van een lier aan de achterzijde.
- Walsen zijn gehard en geslepen
- Assen zijn uit staal, gehard en geslepen.
- Vastzetten door het dichtdraaien van de bovenste wals.

Gemotoriseerde profielwalsmachine PRM10E:

- met twee aangedreven rollen door middel van een krachtige motor tweesnelheids motor.
- kan zowel horizontaal als verticaal geplaatst worden.
- Voetpedaalbediening links / rechtslopend met tweede aparte noodstop
- Vergrendelbare hoofdschakelaar, aparte noodstop, start en stopknop.

Geleverd met

- geharde set standaard walsen.
- Onderstel met opbergkast.

Standaard

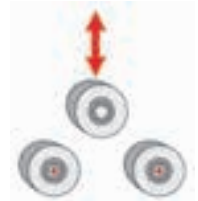

Order nr.	713940010 ^M	713780011 ^M
Orig. nr.	PRM10M	PRM10E
Motorisch	x	✓
Spanning	V	400
Vermogen motor	kW	1,1
Snelheid	m/min	8
Diameter as	mm	30
Diameter wals boven	mm	98
Diameter wals onder	mm	118
Gewicht	kg	230,00
Afmetingen (l x b x h)	mm	620 x 560 x 1440
Prijs	€	859,00
		1.739,00



Optionele walsenset in nylon (ertalon) voor PRM10M. Een set wordt telkens op maat gemaakt voor 1 type profiel.
!! Bij bestelling steeds de profielafmeting en het te verwerken materiaal opgeven.

Order nr.	800170225 ^M
Orig. nr.	PRM10M-R
Capaciteit	mm
Prijs	€
	456,00



Standaard

Profiel	Max. prof. dik.	Max. min.
	20 x 10 20 x 6	600 300
	20 x 12 20 x 6	200 400
	20 x 20 20 x 10	600 300
	20 x 8 20 x 3	600 400
	20 x 8 20 x 3	600 400
	20 x 8 20 x 3	600 400

Optioneel

Material	Max. prof. dik.	Max. min.
	20 x 10 x 2 20 x 20 x 6	600 300
	20 x 20 x 6 20 x 20 x 6	600 400
	20 20 x 6	600 200
	20 x 10 x 2 20 x 20 x 6	600 600
	100 x 10 x 2 100 x 10 x 2	600 300
	40 x 2 20 x 2	1200 600
	100 x 20 x 2 40 x 20 x 2	1200 600

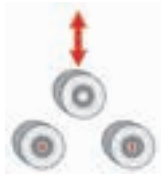

Profielwalsmachine voor horizontaal en vertikaal gebruik.

- Zware gelaste constructie uit staal.
- kan zowel horizontaal als verticaal geplaatst worden
- Twee onderste walsen worden direct motorisch aangedreven.
- Walsen uit gehard en geslepen staal.
- Assen zijn eveneens uit staal, gehard en geslepen.
- Manueel toezetten van de bovenste wals
- Zijdelingse richtrollen traploos regelbaar voor fijnafstelling.
- Uitgerust met een krachtige tweenselheidsmotor 400V
- Links / rechtslopend door middel van voetpedaalbediening
- Vergrendelbare hoofdschakelaar, start en stopknop, aparte noodstop

Geleverd met sokkel,

- Standaard rolwalsen* (zie tabel)
- Verplaatsbare voetpedaal met afzonderlijke noodstop
- Richtrollen
- Onderstel
- Zonder stekker.

Optioneel: digitale afstelling 713880075 en buigaccessoire voor spiralen 713880152

Met standaard meegeleverde rollen voor platte en vierkante volle profielen. Opties: www.vynckier.biz. Bij bestelling steeds de buitenafmeting en het te verwerken materiaal opgeven.

Order nr.	713812030	
Orig. nr.	PRM30F	
Motorisch	✓	
Spanning	V	3x400
Vermogen motor	kW	0,70,85
Snelheid	m/min	3-6
Diameter as	mm	30
Diameter wals boven	mm	148
Diameter wals onder	mm	118
Gewicht	kg	220,00
Afmetingen (l x b x h)	mm	650 x 500 x 1400
Prijs	€	3.490,00

metallkraft



Optionele walsensets in nylon (ertalon of staal) voor PRM30F. Een Set wordt telkens op maat gemaakt voor 1 type profiel (materiaalsoort en afmetingen).

!!! Bij bestelling steeds de profielafmeting en het te verwerken materiaal opgeven. Op aanvraag zijn ook rollensets leverbaar voor L, U, en T-profielen.

Order nr.	Orig. nr.	Omschrijving	Capaciteit rond mm	Capaciteit vierkant mm	Prijs €
713880077 ^M	3880077	staalrollen	0-33,7		399,00
713880078 ^M	3880078	staalrollen	34-48,3		399,00
713880080 ^M	3880080	staalrollen		30x30x3	454,00
713880081 ^M	3880081	staalrollen		40x40x5	454,00
713880082 ^M	3880082	ertalonrollen	0-33,7		307,00
713880083 ^M	3880083	ertalonrollen	34-48,3		395,00
713880085 ^M	3880085	ertalonrollen		30x30x3	499,00
713880086 ^M	3880086	plasticrollen		40x40x5	499,00

metallkraft

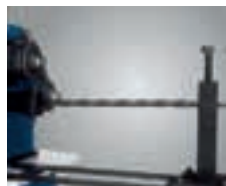

Accessoires voor profiel-buigmachine PRM30F.

713880151 Optionele plooiapparaat voor het draaien van stangen, bv; smeedijzeren sierstangen.

713380152 Optioneel spiraalapparaat voor het plooiën van spiralen, bv; voor aan sierhek.

Order nr.		713880151 ^M	713880152 ^M
Orig. nr.		3880151	3880152
Omschrijving		stangen	spiralen
Voor type		PRM30F	PRM30F
Prijs	€	1.679,00	1.679,00



Standaard

Material	max. grootte	min. lengte
	80 x 30	500
	40 x 20	200
	100 x 25	400
	60 x 30	250
	25 x 20	300
	30 x 20	300
	40 x 7	700
	30 x 5	500
	40 x 7	700
	30 x 5	500
	40x60	1000
	40x60	1000
	40x60	1000
	40x60	1000
	40 x 7	600
	40 x 5	600

Optioneel

Material	max. grootte	min. lengte
	30 x 50 x 5	1000
	40 x 60 x 5	800
	30 x 50 x 4	1000
	30 x 30 x 5	500
	Ø 33	600
	Ø 33	400
	Ø 20 x 7	1000
	Ø 30 x 7	500
	17 x 2,25	1000
	17 x 2,25	500
	40 x 5	1000
	40 x 5	400
	30 x 20 x 2	1000
	30 x 20 x 5	1000

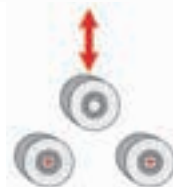

Profielwalsmachine voor horizontaal en verticaal gebruik.

- Zware gelaste constructie uit staal.
- kan zowel horizontaal als verticaal geplaatst worden
- Twee onderste walsen worden direct motorisch aangedreven.
- Walsen uit gehard en geslepen staal.
- Assen zijn eveneens uit staal, gehard en geslepen.
- Manueel toezetten van de bovenste wals
- Zijdelingse richtrollen traploos regelbaar voor fijnafstelling.
- Uitgerust met een krachtige tweenselheidsmotor 400V
- Links / rechtslopend door middel van voetpedaalbediening
- Vergrendelbare hoofdschakelaar, start en stopknop, aparte noodstop

Geleverd met

- sokkel,
- Standaard rolwalsen voor plat / vierkant vol materiaal * (zie tabel)
- Verplaatsbare voetpedaal met afzonderlijke noodstop
- Richtrollen
- Onderstel
- Zonder stekker.

Met standaard meegeleverde rollen voor platte en vierkante volle profielen. Opties: www.vynckier.biz. Bij bestelling steeds de buitenafmeting en het te verwerken materiaal opgeven.

Order nr.		713812035
Orig. nr.		PRM35F
Motorisch		✓
Spanning	V	3x400
Vermogen motor	kW	1,5
Snelheid	m/min	4,5
Diameter as	mm	50
Diameter wals boven	mm	155
Gewicht	kg	400,00
Afmetingen (l x b x h)	mm	750 x 1000 x 1400
Prijs	€	3.990,00



fractali-wafl



Optionele walsensets (ertalon of staal) voor PRM35F. Bij bestelling steeds de profielafmeting en het te verwerken materiaal opgeven. Op aanvraag zijn ook rollensets leverbaar voor L, U, en T-profielen. Opgepast: 1 set per profielmaat.

Order nr.	Orig. nr.	Capaciteit rond mm	Omschrijving	Capaciteit vierkant mm	Prijs €
713880089	3880089	0-33,7	staalrollen		535,00
713880090	3880090	34-48,3	staalrollen		635,00
713880091	3880091	49-60,3	staalrollen		699,00
713880092	3880092		staalrollen	30x30x3	479,00
713880093	3880093		staalrollen	40x40x5	479,00
713880094	3880094		staalrollen	50x50x6	479,00
713880095	3880095	0-33,7	ertalonrollen		395,00
713880096	3880096	34-48,3	ertalonrollen		462,00
713880097	3880097	49-60,3	ertalonrollen		489,00
713880098	3880098		ertalonrollen	30x30x3	499,00
713880099	3880099		ertalonrollen	40x40x5	499,00
713880100	3880100		ertalonrollen	50x50x6	499,00

fractali-wafl



Accessoires voor profielbuigmachine PRM35F:

713880087 Digitale weergave van de toezetwals

713880153 Optionele plooiapparaat voor het draaien van stangen, bvb smeedijzeren sierstangen.

713380154 Optioneel spiraalapparaat voor het plooiën van spiralen, bvb voor aan sierhek.

Order nr.	713880087	713880088	713880153
Orig. nr.	3880087	3880588	3880153
Omschrijving	digitale uitlezing	zijrollen L-profielen	stangen
Prijs	€ 895,00	1.109,00	1.679,00

Standaard			Optioneel		
Bestelcode	max. gew. (kg)	max. lengte (m)	Bestelcode	max. gew. (kg)	max. lengte (m)
80x10	200	100	50x50x3	2000	1000
80x15	300	150	60x60x3	4000	2000
80x17,5	450	225	70x70x3	4500	2250
80x20	600	300	80x80x3	5000	2500
80x25	750	375	90x90x3	6000	3000
80x30	900	450	100x100x3	7000	3500
80x35	1050	525	110x110x3	8000	4000
80x40	1200	600	120x120x3	9000	4500
80x45	1350	675	130x130x3	10000	5000
80x50	1500	750	140x140x3	11000	5500
80x55	1650	825	150x150x3	12000	6000
80x60	1800	900	160x160x3	13000	6500
80x65	1950	975	170x170x3	14000	7000
80x70	2100	1050	180x180x3	15000	7500
80x75	2250	1125	190x190x3	16000	8000
80x80	2400	1200	200x200x3	17000	8500
80x85	2550	1275	210x210x3	18000	9000
80x90	2700	1350	220x220x3	19000	9500
80x95	2850	1425	230x230x3	20000	10000
80x100	3000	1500	240x240x3	21000	10500
80x105	3150	1575	250x250x3	22000	11000
80x110	3300	1650	260x260x3	23000	11500
80x115	3450	1725	270x270x3	24000	12000
80x120	3600	1800	280x280x3	25000	12500
80x125	3750	1875	290x290x3	26000	13000
80x130	3900	1950	300x300x3	27000	13500
80x135	4050	2025	310x310x3	28000	14000
80x140	4200	2100	320x320x3	29000	14500
80x145	4350	2175	330x330x3	30000	15000
80x150	4500	2250	340x340x3	31000	15500
80x155	4650	2325	350x350x3	32000	16000
80x160	4800	2400	360x360x3	33000	16500
80x165	4950	2475	370x370x3	34000	17000
80x170	5100	2550	380x380x3	35000	17500
80x175	5250	2625	390x390x3	36000	18000
80x180	5400	2700	400x400x3	37000	18500
80x185	5550	2775	410x410x3	38000	19000
80x190	5700	2850	420x420x3	39000	19500
80x195	5850	2925	430x430x3	40000	20000
80x200	6000	3000	440x440x3	41000	20500
80x205	6150	3075	450x450x3	42000	21000
80x210	6300	3150	460x460x3	43000	21500
80x215	6450	3225	470x470x3	44000	22000
80x220	6600	3300	480x480x3	45000	22500
80x225	6750	3375	490x490x3	46000	23000
80x230	6900	3450	500x500x3	47000	23500
80x235	7050	3525	510x510x3	48000	24000
80x240	7200	3600	520x520x3	49000	24500
80x245	7350	3675	530x530x3	50000	25000
80x250	7500	3750	540x540x3	51000	25500
80x255	7650	3825	550x550x3	52000	26000
80x260	7800	3900	560x560x3	53000	26500
80x265	7950	3975	570x570x3	54000	27000
80x270	8100	4050	580x580x3	55000	27500
80x275	8250	4125	590x590x3	56000	28000
80x280	8400	4200	600x600x3	57000	28500
80x285	8550	4275	610x610x3	58000	29000
80x290	8700	4350	620x620x3	59000	29500
80x295	8850	4425	630x630x3	60000	30000
80x300	9000	4500	640x640x3	61000	30500
80x305	9150	4575	650x650x3	62000	31000
80x310	9300	4650	660x660x3	63000	31500
80x315	9450	4725	670x670x3	64000	32000
80x320	9600	4800	680x680x3	65000	32500
80x325	9750	4875	690x690x3	66000	33000
80x330	9900	4950	700x700x3	67000	33500
80x335	10050	5025	710x710x3	68000	34000
80x340	10200	5100	720x720x3	69000	34500
80x345	10350	5175	730x730x3	70000	35000
80x350	10500	5250	740x740x3	71000	35500
80x355	10650	5325	750x750x3	72000	36000
80x360	10800	5400	760x760x3	73000	36500
80x365	10950	5475	770x770x3	74000	37000
80x370	11100	5550	780x780x3	75000	37500
80x375	11250	5625	790x790x3	76000	38000
80x380	11400	5700	800x800x3	77000	38500
80x385	11550	5775	810x810x3	78000	39000
80x390	11700	5850	820x820x3	79000	39500
80x395	11850	5925	830x830x3	80000	40000
80x400	12000	6000	840x840x3	81000	40500
80x405	12150	6075	850x850x3	82000	41000
80x410	12300	6150	860x860x3	83000	41500
80x415	12450	6225	870x870x3	84000	42000
80x420	12600	6300	880x880x3	85000	42500
80x425	12750	6375	890x890x3	86000	43000
80x430	12900	6450	900x900x3	87000	43500
80x435	13050	6525	910x910x3	88000	44000
80x440	13200	6600	920x920x3	89000	44500
80x445	13350	6675	930x930x3	90000	45000
80x450	13500	6750	940x940x3	91000	45500
80x455	13650	6825	950x950x3	92000	46000
80x460	13800	6900	960x960x3	93000	46500
80x465	13950	6975	970x970x3	94000	47000
80x470	14100	7050	980x980x3	95000	47500
80x475	14250	7125	990x990x3	96000	48000
80x480	14400	7200	1000x1000x3	97000	48500
80x485	14550	7275	1010x1010x3	98000	49000
80x490	14700	7350	1020x1020x3	99000	49500
80x495	14850	7425	1030x1030x3	100000	50000
80x500	15000	7500	1040x1040x3	101000	50500
80x505	15150	7575	1050x1050x3	102000	51000
80x510	15300	7650	1060x1060x3	103000	51500
80x515	15450	7725	1070x1070x3	104000	52000
80x520	15600	7800	1080x1080x3	105000	52500
80x525	15750	7875	1090x1090x3	106000	53000
80x530	15900	7950	1100x1100x3	107000	53500
80x535	16050	8025	1110x1110x3	108000	54000
80x540	16200	8100	1120x1120x3	109000	54500
80x545	16350	8175	1130x1130x3	110000	55000
80x550	16500	8250	1140x1140x3	111000	55500
80x555	16650	8325	1150x1150x3	112000	56000
80x560	16800	8400	1160x1160x3	113000	56500
80x565	16950	8475	1170x1170x3	114000	57000
80x570	17100	8550	1180x1180x3	115000	57500
80x575	17250	8625	1190x1190x3	116000	58000
80x580	17400	8700	1200x1200x3	117000	58500
80x585	17550	8775	1210x1210x3	118000	59000
80x590	17700	8850	1220x1220x3	119000	59500
80x595	17850	8925	1230x1230x3	120000	60000
80x600	18000	9000	1240x1240x3	121000	60500
80x605	18150	9075	1250x1250x3	122000	61000
80x610	18300	9150	1260x1260x3	123000	61500
80x615	18450	9225	1270x1270x3	124000	62000
80x620	18600	9300	1280x1280x3	125000	62500
80x625	18750	9375	1290x1290x3	126000	63000
80x630	18900	9450	1300x1300x3	127000	63500
80x635	19050	9525	1310x1310x3	128000	64000
80x640	19200	9600	1320x1320x3	129000	64500
80x645	19350	9675	1330x1330x3	130000	65000
80x650	19500	9750	1340x1340x3	131000	65500
80x655	19650	9825	1350x1350x3	132000	66000
80x660	19800	9900	1360x1360x3	133000	66500
80x665	19950	9975	1370x1370x3	134000	67000
80x670	20100	10050	1380x1380x3	135000	67500
80x675	20250	10125	1390x1390x3	136000	68000
80x680	20400	10200	1400x1400x3	137000	68500
80x685	20550	10275	1410x1410x3	138000	69000
80x690	20700	10350	1420x1420x3	139000	69500
80x695	20850	10425	1430x1430x3	140000	70000
80x700	21000	10500	1440x1440x3	141000	70500
80x705	21150	10575	1450x1450x3	142000	71000
80x710	21300	10650	1460x1460x3	143000	71500
80x715	21450	10725	1470x1470x3	144000	72000
80x720	21600	10800	1480x1480x3	145000	72500
80x725	21750	10875	1490x1490x3	146000	73000
80x730	21900	10950	1500x1500x3	147000	73500
80x735	22050	11025	1510x1510x3	148000	74000
80x740	22200	11100	1520x1520x3	149000	74500
80x745	22350	11175	1530x1530x3	150000	75000
80x750	22500	11250	1540x1540x3	151000	75500
80x755	22650	11325	1550x1550x3	152000	76000
80x760	22800	11400	1560x1560x3	153000	76500
80x765	22950	11475	1570x1570x3	154000	77000
80x770	23100	11550	1580x1580x3	155000	77500
80x775	23250	11625	1590x1590x3	156000	78000
80x780	23400	11700	1600x1600x3	157000	78500
80x785	23550	11775	1610x1610x3	158000	79

Rolmachines

frankl-schiff



Walstoestel met 3 rollen

- Geschikt voor eenvoudig werk zoals werven, standenbouwers, enz.
- Voor het plooiën van buizen, kegels, cilinders,...
- Walsen uit hoogwaardig staal.
- Uitzwenkbare bovenwals voor gemakkelijker wegnemen van het werkstuk.
- Achterste wals is schuin verstelbaar voor het conisch ronden.
- Onderste en achterste wals met draadinleggleuf.
- Aandrijving van de walsen via handhendel en tandwielen.
- Door de kleine dikte van de walsen optimaal geschikt voor "filigran" toepassingen.
- Optioneel leverbaar onderstel 713780113.

Order nr.		713940112 ^M	713780618 ^M
Orig. nr.		RBM305	RBM610-8
Werkbreedte	mm	305	610
Diameter rollen	mm	25	38
Plaatdikte	mm	0,80	0,80
Minimum roldiameter	mm	40	60
Gewicht	kg	14,00	40,00
Afmetingen (l x b x h)	mm	580 x 210 x 255	885 x 220 x 340
Prijs	€	222,00	329,00



Onderbouw voor walstoestel RBM305 .

Order nr.		713940113 ^M
Orig. nr.		3940113
Prijs	€	82,00



RBM1000-20 ECO

Manueel aangedreven roltoestel met 3 asymmetrische rollen.

- Voor industrie en ambachtwerk.
- Geschikt voor het vervaardigen van ronde vormen zoals buizen, kegels, cilinders, enz.
- Wegdraaibare bovenrol voor het gemakkelijk uitnemen van het werkstuk.
- Asymmetrische rolinstelling voor het gemakkelijk voorbuigen.
- Achterrol kan schuin worden ingesteld voor conisch rollen.
- Voor- en achterrol voorzien van een draad-inleg.
- Eenvoudig instelbare boven- en onderrol.
- Aandrijving van de rollen door een hendel met tandwielaandrijving.

Geleverd met:

- Onderstel

Order nr.		713781301 
Orig. nr.		RBM1000-20 ECO
Werkbreedte	mm	1000
Diameter rollen	mm	60
Plaatdikte	mm	2,0
Minimum roldiameter	mm	100
Gewicht	kg	240,00
Afmetingen (l x b x h)	mm	1542 x 550 x 1040
Prijs	€	1.290,00

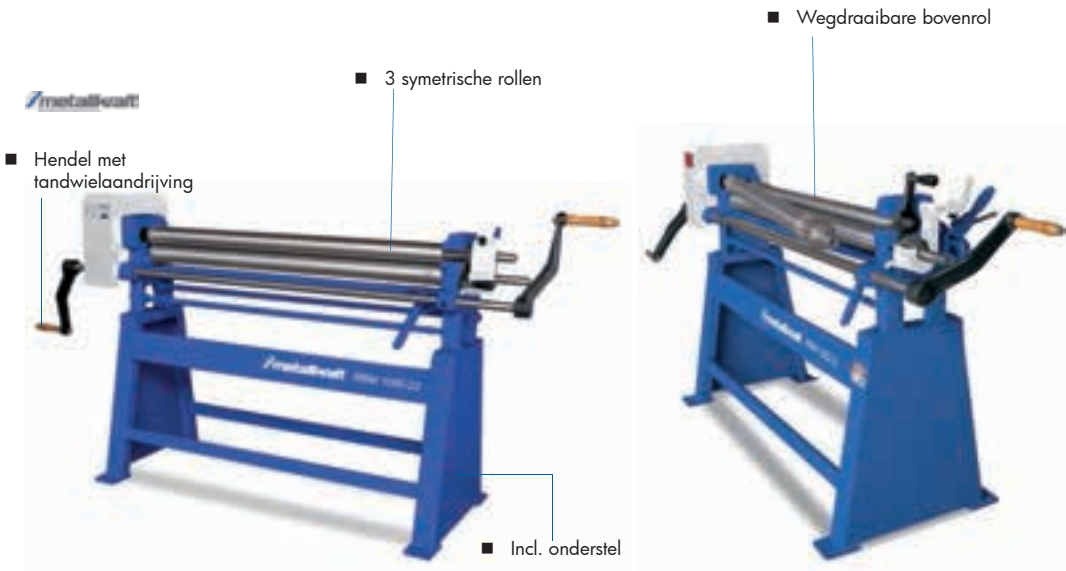

Manueel aangedreven roltoestel met 3 asymetrische rollen.

- Voor industrie en ambachtwerk.
- Geschikt voor het vervaardigen van ronde vormen zoals buizen, kegels, cilinders, enz.
- Wegdraaibare bovenrol voor het gemakkelijk uitnemen van het werkstuk.
- Asymetrische rolinstelling voor het gemakkelijk voorbuigen.
- Achterrol kan schuin worden ingesteld voor conisch rollen.
- Voor- en achterrol voorzien van een draad-inleg.
- Eenvoudig instelbare boven- en onderrol.
- Aandrijving van de rollen door een hendel met tandwielaandrijving.

Geleverd met:

- Onderstel

Order nr.		713813103 
Orig. nr.		RBM 105-22
Werkbreedte	mm	1050
Diameter rollen	mm	75
Plaatdikte	mm	2,0
Minimum roldiameter	mm	115
Gewicht	kg	300,00
Afmetingen (l x b x h)	mm	1400 x 700 x 1120
Prijs	€	1.980,00



RBM1270-25E

Gemotoriseerde plaatrolmachine met 3 asymmetrische rollen en voetpedaalbediening voor de industrie en ambacht.

- Zware en stabiele gietijzerenconstructie
- Asymmetrische 3 rollensysteem voor het correct voorbuigen
- Zwenkbare bovenwals
- Plaatdiktes opgegeven materiaal treksterkte tot 400N/mm². Voor het konisch buigen factor 0,5; voor roestvrij staal factor 0,75 en voor alu 1,2
- Door de voetpedaalbediening met noodstop blijven beide handen vrij om het materiaal aan te voeren.
- Krachtige 400V motor
- Optioneel geharde rollen te verkrijgen (ST 1050 hoge drukstaal) 713880059
- Boven en onderwals zijn aangedreven
- Beveiligingsperimeter met noodstopfunctie
- Vergrendelbare hoofdschakelaar
- Elektrische uitrusting met degelijke componenten.

Optioneel zijn nog volgende zaken te verkrijgen: gemotoriseerd toezetten van de achterste rol 713880060; digitale weergave van de toezetrol 713880061.

Ook verkrijgbaar in 1270 (713813202), 1550 (713813203) en 2050 mm (713813204).

Order nr.		713813201
Orig. nr.		RBM1050-30E
Werkbreedte	mm	1050
Diameter rollen	mm	90
Plaatdikte	mm	3,0
Vermogen motor	kW	1,5
Spanning	V	400
Rolsnelheid	m/min	6
Gewicht	kg	480,00
Afmetingen (l x b x h)	mm	1630 x 700 x 1200
Prijs	€	5.840,00

Uithoekscharen

 Metallkraft



Manuele uithoekschaar **met 3 mm snijcapaciteit** in staal.

- Zware gietijzeren constructie voor het snel uitknippen van hoeken in metalen en andere materialen.
- Vaste snijhoek 90°.
- Roestvrijstaal 2 mm.
- Slag 30 mm
- Met gradenverdeling en instelbare aanslagen.

Order nr.		713770512 
Orig. nr.		AKM100T
Snijcapaciteit	mm	3
Snijbereik	mm	100x100
Snijhoek	°	90
Werktafel	mm	380x280
Gewicht	kg	105,00
Afmetingen (l x b x h)	mm	450 x 390 x 1020
Prijs	€	795,00



7138132002
Plaatrolmachine 3 walsen



713813303
Plaatrolmachine 3 walsen tot 5mm



713813315
Plaatrolmachine 3 walsen tot 6mm



713817005
Hydraulische uithoekmachine



713819045
Ponsknipmachine



713818065
Ponsmachine

BENDING ROLLS TECHNOLOGY

Nosstec offers the market a wide variety of machines, independent if you need one for simple single piece bending roll work or if you produce high volumes of products with high requirements. As a bonus we will support you with a machine with the highest quality on the market.

Scope of capacities shown are based on mild carbon steel (400N/mm²)



Roll setups



The basic setup suitable for less demanding applications but on the other hand a very robust solution. With this kind of setup no prebending is possible to perform.



The most conventional setup for most of our machines. Prebending is possible and products of high quality can be produced.

Prebending

In order to produce round tubes or rounded profiles a prebending is a must. Our different roll setups work in different ways as shown here.

- 1) Asymmetrical roll set-up where the sheet metal has to be run from the backside initially thereafter from the front.



Fig. 2

Rolmachines voor elke productie of toepassing vindt u in ons Nosstec gamma: rolcapaciteiten tot 2500mm of 6mm dikte, motorisch of eenvoudig manueel. Meer info op www.vynckier.biz.



Ponsknipmachines



Industriële ponsknipmachines.

Amerikaanse fabrikant van ponsknipmachines sedert 1875, ondersteunt de staalconstructie industrie met een volledige lijn, lage kost en gering in onderhoud ponsknipmachines. Lang aanzien als het Zwitsers zakmes van de industrie, deze machines doen werkelijk alles ponsen, knippen, uithoeken en zelfs plooiën van constructiestaal. Een breed gamma van accessoires is beschikbaar om van alles en nog wat te doen.

De ponsknipmachines worden in alle taken van de staalbouw gebruikt. Als een tijdbesparende alternatief voor een zaag, of kunnen alle standaard ponsknipmachines worden uitgerust met optionele tooling om u te helpen het meeste uit uw tijd en geld te halen. Van zware structurele stalen bouwcomponenten tot delicaat siersmeedwerk, trailerbouw, etc. Dit zijn de meest veelzijdige, tijdbesparende machine voor in elk atelier.

Order nr.		790023105 ^(M)	790023115 ^(M)
Orig. nr.		PKM40T	PKM55T
Capaciteit	T	40	55
Uitlading	mm	178	178
Open hoogte	mm	203	203
Gesloten hoogte	mm	178	171,5
Slag	mm	35	31,75
Cyclustijd	sec	2	2
Vermogen motor	kW	3,75	3,75
Spanning	V	3x400	3x400
Hydraulische pomp	l/m	13,25	13,25
Druk	bar	180	180
Tankinhoud	l	26,5	26,5
Cilinder	mm/r	63,5	63,5
Basis afmetingen	mm	582x1050	915x1080
Hoogte	mm	1.550	1.500
Uitlading	mm	178	178
Open hoogte	mm	203	203
Gesloten hoogte	mm	178	171,5
Slag	mm	35	31,75
Ponsen			
Maximum capaciteit	mm	25mm dia. in 13mm plaatdikte	27mm dia. in 16mm plaatdikte
Werkhoogte	mm	1.100	895
Knippen			
Werkhoogte	mm	865	895
Maximum breedte	mm	10x254	13x300 - 10x350
Maximum dikte	mm		19x100
Maximum rond	mm		22
Maximum vierkant	mm		22
Werkhoogte	mm	865	895
Profiel knippen			
Werkhoogte	mm	1.370	1.016
Maximale afmetingen	mm	50x102x5 - 76x76x7	100x100x6 - 76x76x9,5
Open station			
Uitlading	mm	163	178
Open hoogte	mm	203	203
Gesloten hoogte	mm	170	171,5
Slag	mm	33	31,75
Werkhoogte	mm	1.047	895
Uitlading	mm	163	178
Open hoogte	mm	203	203
Gesloten hoogte	mm	170	171,5
Slag	mm	33	31,75
Gewicht	kg	600,00	1100,00
Prijs	€	7.990,00	9.490,00

Werk met Mubea monsen en matrijzen (p.744)

■ Ponsenheid Ø 25 x 13mm

NEW

■ Ponsenheid Ø 27 x 16mm

■ Uithoek 100 x 100 x 6mm

■ Plat ijzer
350 x 10 mm

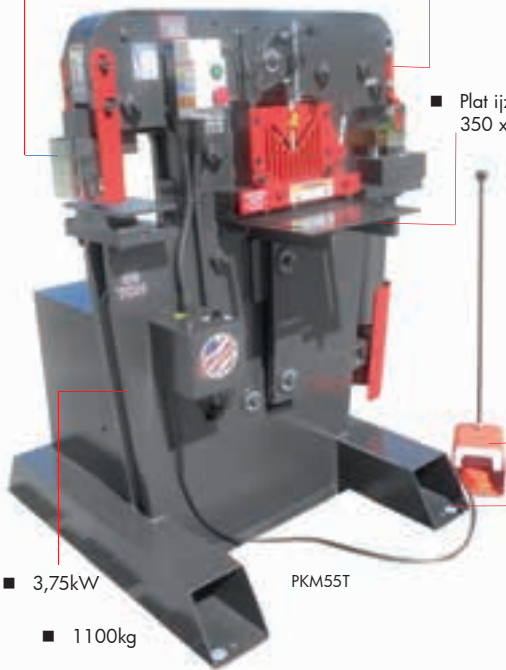

■ 3,75kW

PKM55T

■ 1100kg

■ Voetpedaalbediening

■ Eenvoudig verplaatsbaar



NEW

■ Uithoek
75 x 75 x 6mm

■ Platijzer
250 x 10mm

■ 875kg

■ Eenvoudig
verplaatsbaar

PKM40T

■ 3,75kW

Belangrijkste kenmerken PKM40T:

- 4 beschikbare werkstations: Ponsstation, Universeel open station voor optionele tooling, 250 mm knipstation, Hoekschaar
- Elektrische voetpedaal bediening
- Elektrisch gecontroleerde diepteinstelling
- Snelwissel systeem
- Krachtige hydraulische groep
- Eenvoudig vertransporteerbaar
- Robuust in afwerking met voldoende smeernippels voor goede smering en werking
- Gepoederlakt voor een perfecte afwerkingsgraad.
- CE kenmerk
- Nederlandstalige handleiding met CE certificaat 2006/42/CE, 2004/108/CE en 2006/95/CE
- Gevuld met hydraulische olie
- Werkt met ponsen en matrijzen Mubea

Ponsen en matrijzen

Mubea for METALWORKS

NEW



Mubea ronde ponsen en matrijzen Gr. 1.

De afmetingen van het gat dat u wenst te ponsen wordt bepaald door de pons afmetingen. De ponsen worden aangeduid met deze afmeting.

De matrijsopening moet wijder zijn dan de speling (= tweemaal de snij opening). Volgens onze ervaring bedraagt de speling ongeveer 10% van de materiaaldikte.

De matrijs aanduiding toont de actuele afmetingen van de snij opening (opening van de matrijs).

Grondregels:

1. Wanneer u de speling bepaalt, raden wij u aan de volgende regels te volgen:

Voor ronde ponsen:

Materiaaldikte tot 4mm, spelling 0,2mm

Materiaaldikte tot 4-9mm, spelling 0,7mm

Materiaaldikte tot 9-14mm, spelling 1,2mm

Materiaaldikte tot 14-19mm, spelling 1,7mm

Materiaaldikte tot 19-24mm, spelling 2,2mm

Bvb.:

- Ponsdiameter: 20,0 mm

- Materiaaldikte: 12,0 mm

- Matrijsopening: 21,2 mm

2. U kunt nooit met een kleinere ponsdiameter een dikkere plaat ponsen. Bvb.:

- Ponsdiameter: 7 mm

- Materiaaldikte: 8 mm

is niet mogelijk.

3. Verzeker u ervan dat de speling altijd in lijn staat tussen pons en matrijs opening.

4. De matrijs, pons houder en reducties dienen veilig bevestigd te worden in hun supports.

5. De afstrijker of neerhouder moeten in overeenstemming handelen en worden uitgelijnd met de oppervlakte van de matrijs

6. Om de hoogst mogelijke levensduur van uw pons te bekomen, dient u de ponsen frequent te smeren, tijdens het ponsen.

7. Om uw ponsknipmachine niet te overbelasten, raden wij u aan rekening te houden met de max. ponscapaciteit aangegeven op de prestatieplaat.

Diameter x materiaaldikte x materiaal trekstrekke (tot 600 N/mm², kunt u de factor 0,8 gebruiken)

Deze ronde ponsen Gr. 1 kunnen enkel ingezet worden door gebruik te maken van de ponsreductie inzet 790504020 en de ponsreductie 790504022.

De ronde matrijzen Gr. 1 enkel door gebruik te maken van de matrijsreducties 790504032 en 790504034.

Order nr.	Orig. nr.	Omschrijving	Diameter mm	Mubea nr	Prijs €
790400002	MBP1-3,0	pons	3,0	50505 11 008	10,10
790400004	MBP1-3,5	pons	3,5	50505 11 011	10,10
790400006	MBP1-4,0	pons	4,0	50505 11 013	10,10
790400008	MBP1-4,5	pons	4,5	50505 11 015	10,10
790400010	MBP1-5,0	pons	5,0	50505 11 017	10,10
790400012	MBP1-5,5	pons	5,5	50505 11 019	10,10
790400014	MBP1-6,0	pons	6,0	50505 11 022	10,10
790400016	MBP1-6,5	pons	6,5	50505 11 024	10,10
790400018	MBP1-7,0	pons	7,0	50505 11 026	10,10
790400020	MBP1-7,5	pons	7,5	50505 11 028	10,10
790400022	MBP1-8,0	pons	8,0	50505 11 031	10,10
790400024	MBP1-8,5	pons	8,5	50505 11 033	10,10
790400026	MBP1-9,0	pons	9,0	50505 11 035	10,10
790400028	MBP1-9,5	pons	9,5	50505 11 037	10,10
790400030	MBP1-10,0	pons	10,0	50505 11 039	10,10
790400032	MBP1-10,5	pons	10,5	50505 11 042	10,10
790400034	MBP1-11,0	pons	11,0	50505 11 044	10,10
790400036	MBP1-11,5	pons	11,5	50505 11 046	10,10
790400038	MBP1-12,0	pons	12,0	50505 11 048	10,10
790400040	MBP1-12,5	pons	12,5	50505 11 051	10,10
790400042	MBP1-13,0	pons	13,0	50505 11 053	10,10
790400044	MBP1-13,5	pons	13,5	50505 11 055	10,10
790400046	MBP1-14,0	pons	14,0	50505 11 057	10,10
790400048	MBP1-14,5	pons	14,5	50505 11 059	10,10
790400050	MBP1-15,0	pons	15,0	50505 11 062	10,10
790500002	MBM1-3,2	matrijs	3,2	50633 01 009	9,00
790500004	MBM1-3,7	matrijs	3,7	50633 01 012	9,00
790500006	MBM1-4,2	matrijs	4,2	50633 01 014	9,00
790500008	MBM1-4,7	matrijs	4,7	50633 01 016	9,00
790500010	MBM1-5,2	matrijs	5,2	50633 01 018	9,00
790500012	MBM1-5,7	matrijs	5,7	50633 01 021	9,00
790500014	MBM1-6,2	matrijs	6,2	50633 01 023	9,00
790500016	MBM1-6,7	matrijs	6,7	50633 01 025	9,00
790500018	MBM1-7,2	matrijs	7,2	50633 01 027	9,00
790500020	MBM1-7,7	matrijs	7,7	50633 01 029	9,00
790500022	MBM1-8,2	matrijs	8,2	50633 01 032	9,00
790500024	MBM1-8,7	matrijs	8,7	50633 01 034	9,00
790500026	MBM1-9,2	matrijs	9,2	50633 01 036	9,00
790500028	MBM1-9,7	matrijs	9,7	50633 01 038	9,00
790500030	MBM1-10,2	matrijs	10,2	50633 01 041	9,00
790500032	MBM1-10,7	matrijs	10,7	50633 01 043	9,00
790500034	MBM1-11,2	matrijs	11,2	50633 01 045	9,00
790500036	MBM1-11,7	matrijs	11,7	50633 01 047	9,00
790500038	MBM1-12,2	matrijs	12,2	50633 01 049	9,00
790500040	MBM1-12,7	matrijs	12,7	50633 01 052	9,00
790500042	MBM1-13,2	matrijs	13,2	50633 01 054	9,00
790500044	MBM1-13,7	matrijs	13,7	50633 01 056	9,00
790500046	MBM1-14,2	matrijs	14,2	50633 01 058	9,00
790500048	MBM1-14,7	matrijs	14,7	50633 01 061	9,00
790500050	MBM1-15,2	matrijs	15,2	50633 01 063	9,00
790500052	MBM1-15,7	matrijs	15,7	50633 01 065	9,00
790500054	MBM1-16,2	matrijs	16,2	50633 01 067	9,00

Mubea for METALWORK

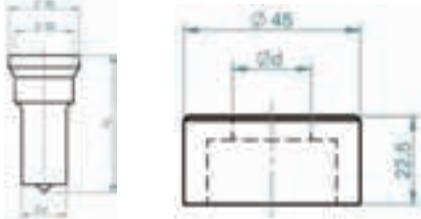

Mubea ronde ponsen en matrijzen Gr.2.

De afmetingen van het gat dat u wenst te ponsen wordt bepaald door de pons afmetingen. De ponsen worden aangeduid met deze afmeting.

De matrijsopening moet wijder zijn dan de speling (= tweemaal de snij opening). Volgens onze ervaring bedraagt de speling ongeveer 10% van de materiaaldikte.

De matrijs aanduiding toont de actuele afmetingen van de snij opening (opening van de matrijs).

Grondregels:

1. Wanneer u de speling bepaalt, raden wij u aan de volgende regels te volgen: Voor ronde ponsen:

Materiaaldikte tot 4mm, spelling 0,2mm

Materiaaldikte tot 4-9mm, spelling 0,7mm

Materiaaldikte tot 9-14mm, spelling 1,2mm

Materiaaldikte tot 14-19mm, spelling 1,7mm

Materiaaldikte tot 19-24mm, spelling 2,2mm

Bvb.:

- Ponsdiameter : 20,0 mm

- Materiaaldikte : 12,0 mm

- Matrijsopening : 21,2 mm

2. U kunt nooit met een kleinere ponsdiameter een dikkere plaat ponsen.

Bvb. :

- Ponsdiameter : 7 mm

- Materiaaldikte : 8 mm

is niet mogelijk.

3. Verzeker u ervan dat de speling altijd in lijn staat tussen pons en matrijs opening.

4. De matrijs, ponshouder en reducties dienen veilig bevestigd te worden in hun supports.

5. De afstrijder of neerhouder moeten in overeenstemming handelen en worden uitgelijnd met de oppervlakte van de matrijs

6. Om de hoogst mogelijke levensduur van uw pons te bekomen, dient u de ponsen frequent te smeren, tijdens het ponsen.

7. Om uw pons-knipmachine niet te overbelasten, raden wij u aan rekening te houden met de max. ponscapaciteit aangegeven op de prestatieplaat.

Diameter x materiaaldikte x materiaal trekstrekte (tot 600 N/mm², kunt u de factor 0,8 gebruiken)

Deze ronde ponsen Gr. 2 kunnen enkel ingezet worden door gebruik te maken van de ponsreductie 790504026.

De ronde matrijzen Gr.2 enkel door gebruik te maken van de matrijsreducties 790504036.

Order nr.	Orig. nr.	Omschrijving	Diameter mm	Mubea nr	Prijs €
790400052	MBP2-15,5	pons	15,5	50505 21 064	14,20
790400054	MBP2-16,0	pons	16,0	50505 21 066	14,20
790400056	MBP2-16,5	pons	16,5	50505 21 068	14,20
790400058	MBP2-17,0	pons	17,0	50505 21 071	14,20
790400060	MBP2-17,5	pons	17,5	50505 21 073	14,20
790400062	MBP2-18,0	pons	18,0	50505 21 075	14,20
790400064	MBP2-18,5	pons	18,5	50505 21 077	14,20
790400066	MBP2-19,0	pons	19,0	50505 21 079	14,20
790400068	MBP2-19,5	pons	19,5	50505 21 082	14,20
790400070	MBP2-20,0	pons	20,0	50505 21 084	14,20
790400072	MBP2-20,5	pons	20,5	50505 21 086	14,20
790400074	MBP2-21,0	pons	21,0	50505 21 088	14,20
790400076	MBP2-21,5	pons	21,5	50505 21 091	14,20
790400078	MBP2-22,0	pons	22,0	50505 21 093	14,20
790400080	MBP2-22,5	pons	22,5	50505 21 095	14,20
790400082	MBP2-23,0	pons	23,0	50505 21 097	14,20
790400084	MBP2-23,5	pons	23,5	50505 21 099	14,20
790400086	MBP2-24,0	pons	24,0	50505 21 102	14,20
790400088	MBP2-24,5	pons	24,5	50505 21 104	14,20
790400090	MBP2-25,0	pons	25,0	50505 21 106	14,20
790400092	MBP2-25,5	pons	25,5	50505 21 108	14,20
790400094	MBP2-26,0	pons	26,0	50505 21 111	14,20
790400096	MBP2-26,5	pons	26,5	50505 21 113	14,20
790400098	MBP2-27,0	pons	27,0	50505 21 115	14,20
790400100	MBP2-27,5	pons	27,5	50505 21 117	14,20
790400102	MBP2-28,0	pons	28,0	50505 21 119	14,20
790400104	MBP2-28,5	pons	28,5	50505 21 122	14,20
790400106	MBP2-29,0	pons	29,0	50505 21 124	14,20
790400108	MBP2-29,5	pons	29,5	50505 21 126	14,20
790400110	MBP2-30,0	pons	30,0	50505 21 128	14,20
790500056	MBM2-15,7	matrijs	15,7	50638 01 065	15,30
790500058	MBM2-16,2	matrijs	16,2	50638 01 067	15,30
790500060	MBM2-16,7	matrijs	16,7	50638 01 069	15,30
790500062	MBM2-17,2	matrijs	17,2	50638 01 072	15,30
790500064	MBM2-17,7	matrijs	17,7	50638 01 074	15,30
790500066	MBM2-18,2	matrijs	18,2	50638 01 076	15,30
790500068	MBM2-18,7	matrijs	18,7	50638 01 078	15,30
790500070	MBM2-19,2	matrijs	19,2	50638 01 081	15,30
790500072	MBM2-19,7	matrijs	19,7	50638 01 083	15,30
790500074	MBM2-20,2	matrijs	20,2	50638 01 085	15,30
790500076	MBM2-20,7	matrijs	20,7	50638 01 087	15,30
790500078	MBM2-21,2	matrijs	21,2	50638 01 089	15,30
790500080	MBM2-21,7	matrijs	21,7	50638 01 092	15,30
790500082	MBM2-22,2	matrijs	22,2	50638 01 094	15,30
790500084	MBM2-22,7	matrijs	22,7	50638 01 096	15,30
790500086	MBM2-23,2	matrijs	23,2	50638 01 098	15,30
790500088	MBM2-23,7	matrijs	23,7	50638 01 101	15,30
790500090	MBM2-24,2	matrijs	24,2	50638 01 103	15,30
790500092	MBM2-24,7	matrijs	24,7	50638 01 105	15,30
790500094	MBM2-25,2	matrijs	25,2	50638 01 107	15,30
790500096	MBM2-25,7	matrijs	25,7	50638 01 109	15,30
790500098	MBM2-26,2	matrijs	26,2	50638 01 112	15,30
790500100	MBM2-26,7	matrijs	26,7	50638 01 114	15,30
790500102	MBM2-27,2	matrijs	27,2	50638 01 116	15,30
790500104	MBM2-27,7	matrijs	27,7	50638 01 118	15,30
790500106	MBM2-28,2	matrijs	28,2	50638 01 121	15,30
790500108	MBM2-28,7	matrijs	28,7	50638 01 123	15,30
790500110	MBM2-29,2	matrijs	29,2	50638 01 125	15,30
790500112	MBM2-29,7	matrijs	29,7	50638 01 127	15,30
790500114	MBM2-30,2	matrijs	30,2	50638 01 129	15,30
790500116	MBM2-30,7	matrijs	30,7	50638 01 132	15,30
790500118	MBM2-31,2	matrijs	31,2	50638 01 134	15,30
790500120	MBM2-31,7	matrijs	31,7	50638 01 136	15,30

Mubea for METALWORKS

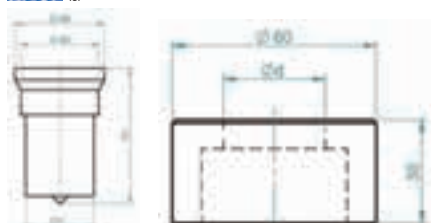

Mubea ronde ponsen en matrijzen Gr.3.

De afmetingen van het gat dat u wenst te ponsen wordt bepaald door de pons afmetingen. De ponsen worden aangeduid met deze afmeting.

De matrijsopening moet wijder zijn dan de speling (= tweemaal de snij opening). Volgens onze ervaring bedraagt de speling ongeveer 10% van de materiaaldikte.

De matrijs aanduiding toont de actuele afmetingen van de snij opening (opening van de matrijs).

Grondregels:

1. Wanneer u de speling bepaalt, raden wij u aan de volgende regels te volgen:

Voor ronde ponsen:

Materiaaldikte tot 4mm, spelling 0,2mm

Materiaaldikte tot 4-9mm, spelling 0,7mm

Materiaaldikte tot 9-14mm, spelling 1,2mm

Materiaaldikte tot 14-19mm, spelling 1,7mm

Materiaaldikte tot 19-24mm, spelling 2,2mm

Bvb.:

- Ponsdiameter : 20,0 mm

- Materiaaldikte : 12,0 mm

- Matrijsopening : 21,2 mm

2. U kunt nooit met een kleinere ponsdiameter een dikkere plaat ponsen. Bvb. : - Ponsdiameter : 7 mm

- Materiaaldikte : 8 mm

is niet mogelijk.

3. Verzeker u ervan dat de speling altijd in lijn staat tussen pons en matrijs opening.

4. De matrijs, ponshouder en reducties dienen veilig bevestigd te worden in hun supports.

5. De afstrijker of neerhouder moeten in overeenstemming handelen en worden uitgelijnd met de oppervlakte van de matrijs

6. Om de hoogst mogelijke levensduur van uw pons te bekomen, dient u de ponsen frequent te smeren, tijdens het ponsen.

7. Om uw pons-knipmachine niet te overbelasten, raden wij u aan rekening te houden met de max. ponscapaciteit aangegeven op de prestatieplaat.

Diameter x materiaaldikte x materiaal trekstrekte.

(tot 600 N/mm², kunt u de factor 0,8 gebruiken)

Enkel te gebruiken bij Mubea pons/knipmachines uitgerust met de speciale ponsenheid, die ponsen van ø 30,5 tot 50 mm kan opnemen. Of andere merken die standaard tot ø 40 mm kunnen opnemen.

Order nr.	Orig. nr.	Omschrijving	Diameter mm	Mubea nr	Prijs €
790400112	MBP3-30,5	pons	30,5	50505 31 131	29,80
790400114	MBP3-31,0	pons	31,0	50505 31 133	29,80
790400116	MBP3-31,5	pons	31,5	50505 31 135	29,80
790400118	MBP3-32,0	pons	32,0	50505 31 137	29,80
790400120	MBP3-32,5	pons	32,5	50505 31 139	29,80
790400122	MBP3-33,0	pons	33,0	50505 31 142	29,80
790400124	MBP3-33,5	pons	33,5	50505 31 144	29,80
790400126	MBP3-34,0	pons	34,0	50505 31 146	29,80
790400128	MBP3-34,5	pons	34,5	50505 31 148	29,80
790400130	MBP3-35,0	pons	35,0	50505 31 151	29,80
790400132	MBP3-35,5	pons	35,5	50505 31 153	29,80
790400134	MBP3-36,0	pons	36,0	50505 31 155	29,80
790400136	MBP3-36,5	pons	36,5	50505 31 157	29,80
790400138	MBP3-37,0	pons	37,0	50505 31 159	29,80
790400140	MBP3-37,5	pons	37,5	50505 31 162	29,80
790400142	MBP3-38,0	pons	38,0	50505 31 164	29,80
790400144	MBP3-38,5	pons	38,5	50505 31 166	29,80
790400146	MBP3-39,0	pons	39,0	50505 31 168	29,80
790400148	MBP3-39,5	pons	39,5	50505 31 171	29,80
790400150	MBP3-40,0	pons	40,0	50505 31 173	29,80
790500122	MBM3-30,7	matrijs	30,7	50639 01 132	28,40
790500124	MBM3-31,2	matrijs	31,2	50639 01 134	28,40
790500126	MBM3-31,7	matrijs	31,7	50639 01 136	28,40
790500128	MBM3-32,2	matrijs	32,2	50639 01 138	28,40
790500130	MBM3-32,7	matrijs	32,7	50639 01 141	28,40
790500132	MBM3-33,2	matrijs	33,2	50639 01 143	28,40
790500134	MBM3-33,7	matrijs	33,7	50639 01 145	28,40
790500136	MBM3-34,2	matrijs	34,2	50639 01 147	28,40
790500138	MBM3-34,7	matrijs	34,7	50639 01 149	28,40
790500140	MBM3-35,2	matrijs	35,2	50639 01 152	28,40
790500142	MBM3-35,7	matrijs	35,7	50639 01 154	28,40
790500144	MBM3-36,2	matrijs	36,2	50639 01 156	28,40
790500146	MBM3-36,7	matrijs	36,7	50639 01 158	28,40
790500148	MBM3-37,2	matrijs	37,2	50639 01 161	28,40
790500150	MBM3-37,7	matrijs	37,7	50639 01 163	28,40
790500152	MBM3-38,2	matrijs	38,2	50639 01 165	28,40
790500154	MBM3-38,7	matrijs	38,7	50639 01 167	28,40
790500156	MBM3-39,2	matrijs	39,2	50639 01 169	28,40
790500158	MBM3-39,7	matrijs	39,7	50639 01 172	28,40
790500160	MBM3-40,2	matrijs	40,2	50639 01 174	28,40
790500162	MBM3-40,7	matrijs	40,7	50639 01 176	28,40
790500164	MBM3-41,2	matrijs	41,2	50639 01 178	28,40
790500166	MBM3-41,7	matrijs	41,7	50639 01 181	28,40
790500168	MBM3-42,2	matrijs	42,2	50639 01 183	28,40

Mubea for METALWORKS

NEW



Mubea vierkante ponsen en matrijzen Gr.1 en 2.
De afmetingen van het gat dat u wenst te ponsen wordt bepaald door de pons afmetingen. De ponsen worden aangeduid met deze afmeting. De matrijsopening moet wijder zijn dan de speling (= tweemaal de snij opening). Volgens onze ervaring bedraagt de speling ongeveer 10% van de materiaaldikte.
De matrijs aanduiding toont de actuele afmetingen van de snij opening (opening van de matrijs).

Grondregels:

1. Wanneer u de speling bepaalt, raden wij u aan de volgende regels te volgen:

Voor vierkante ponsen:

- Materiaaldikte tot 4mm, spelling 0,2mm
- Materiaaldikte tot 4-9mm, spelling 0,7mm
- Materiaaldikte tot 9-14mm, spelling 1,2mm
- Materiaaldikte tot 14-19mm, spelling 1,7mm
- Materiaaldikte tot 19-24mm, spelling 2,2mm
- Ponsdiameter : 20,0mm
- Materiaaldikte : 12,0mm
- Matrijsopening : 21,2mm

2. U kunt nooit met een kleinere ponsdiameter een dikkere plaat ponsen. Bvb. :

- Ponsdiameter : 7 mm
 - Materiaaldikte : 8 mm
- is niet mogelijk.

3. Verzeker u ervan dat de speling altijd in lijn staat tussen pons en matrijs opening. Bvb.:

- Ponsdiameter : 20,0 mm
- Materiaaldikte : 12,0 mm
- Matrijsopening : 21,2 mm

4. De matrijs, ponshouder en reducties dienen veilig bevestigd te worden in hun supports.

5. De afstrijder of neerhouder moeten in overeenstemming handelen en worden uitgelijnd met de oppervlakte van de matrijs

6. Om de hoogst mogelijke levensduur van uw pons te bekomen, dient u de ponsen frequent te smeren, tijdens het ponsen.

7. Om uw ponsknipmachine niet te overbelasten, raden wij u aan rekening te houden met de max. ponscapaciteit aangegeven op de prestatieplaat. Diameter x materiaaldikte x materiaal trekstrekke (tot 600 N/mm², kunt u de factor 0,8 gebruiken)
Deze vierkante ponsen Gr. 2 kunnen enkel ingezet worden door gebruik te maken van de ponsreductie 790504026.

De vierkante matrijzen Gr.1 kunnen enkel gebruikt worden door gebruik te maken van de volgende matrijsreducties 790504032 en 790504034; Gr.2 enkel door 790504036.

Order nr.	Orig. nr.	Omschrijving	Vierkant	Mubea nr	Prijs
			mm		€
790401002	MBPV2-4,0	pons	4,0	50505 22 112	34,00
790401004	MBPV2-4,5	pons	4,5	50505 22 114	34,00
790401006	MBPV2-5,0	pons	5,0	50505 22 116	34,00
790401008	MBPV2-5,5	pons	5,5	50505 22 118	34,00
790401010	MBPV2-6,0	pons	6,0	50505 22 122	34,00

Order nr.	Orig. nr.	Omschrijving	Vierkant	Mubea nr	Prijs
			mm		€
790401012	MBPV2-6,5	pons	6,5	50505 22 124	34,00
790401014	MBPV2-7,0	pons	7,0	50505 22 126	34,00
790401016	MBPV2-7,5	pons	7,5	50505 22 128	34,00
790401018	MBPV2-8,0	pons	8,0	50505 22 132	34,00
790401020	MBPV2-8,5	pons	8,5	50505 22 134	34,00
790401022	MBPV2-9,0	pons	9,0	50505 22 136	34,00
790401024	MBPV2-9,5	pons	9,5	50505 22 138	34,00
790401026	MBPV2-10,0	pons	10,0	50505 22 142	34,00
790401028	MBPV2-10,5	pons	10,5	50505 22 144	34,00
790401030	MBPV2-11,0	pons	11,0	50505 22 146	34,00
790401032	MBPV2-11,5	pons	11,5	50505 22 148	34,00
790401034	MBPV2-12,0	pons	12,0	50505 22 152	34,00
790401036	MBPV2-12,5	pons	12,5	50505 22 154	34,00
790401038	MBPV2-13,0	pons	13,0	50505 22 156	34,00
790401040	MBPV2-13,5	pons	13,5	50505 22 158	34,00
790401042	MBPV2-14,0	pons	14,0	50505 22 162	34,00
790401044	MBPV2-14,5	pons	14,5	50505 22 164	34,00
790401046	MBPV2-15,0	pons	15,0	50505 22 166	34,00
790401048	MBPV2-15,5	pons	15,5	50505 22 168	34,00
790401050	MBPV2-16,0	pons	16,0	50505 22 172	34,00
790401052	MBPV2-16,5	pons	16,5	50505 22 174	34,00
790401054	MBPV2-17,0	pons	17,0	50505 22 176	34,00
790401056	MBPV2-17,5	pons	17,5	50505 22 178	34,00
790401058	MBPV2-18,0	pons	18,0	50505 22 182	34,00
790401060	MBPV2-18,5	pons	18,5	50505 22 184	34,00
790401062	MBPV2-19,0	pons	19,0	50505 22 186	34,00
790401064	MBPV2-19,5	pons	19,5	50505 22 188	34,00
790401066	MBPV2-20,0	pons	20,0	50505 22 192	34,00
790401068	MBPV2-20,5	pons	20,5	50505 22 194	34,00
790401070	MBPV2-21,0	pons	21,0	50505 22 196	34,00
790501002	MBVM1-4,2	matrijs	4,2	50633 02 113	21,20
790501004	MBVM1-4,7	matrijs	4,7	50633 02 115	21,20
790501006	MBVM1-5,2	matrijs	5,2	50633 02 117	21,20
790501008	MBVM1-5,7	matrijs	5,7	50633 02 121	21,20
790501010	MBVM1-6,2	matrijs	6,2	50633 02 123	21,20
790501012	MBVM1-6,7	matrijs	6,7	50633 02 125	21,20
790501014	MBVM1-7,2	matrijs	7,2	50633 02 127	21,20
790501016	MBVM1-7,7	matrijs	7,7	50633 02 131	21,20
790501018	MBVM1-8,2	matrijs	8,2	50633 02 133	21,20
790501020	MBVM1-8,7	matrijs	8,7	50633 02 135	21,20
790501022	MBVM1-9,2	matrijs	9,2	50633 02 137	21,20
790501024	MBVM1-9,7	matrijs	9,7	50633 02 141	21,20
790501026	MBVM1-10,2	matrijs	10,2	50633 02 143	21,20
790501028	MBVM1-10,7	matrijs	10,7	50633 02 145	21,20
790501030	MBVM1-11,2	matrijs	11,2	50633 02 147	21,20
790501032	MBVM2-11,7	matrijs	11,7	50638 02 151	32,90
790501034	MBVM2-12,2	matrijs	12,2	50638 02 153	32,90
790501036	MBVM2-12,7	matrijs	12,7	50638 02 155	32,90
790501038	MBVM2-13,2	matrijs	13,2	50638 02 157	32,90
790501040	MBVM2-13,7	matrijs	13,7	50638 02 161	32,90
790501042	MBVM2-14,2	matrijs	14,2	50638 02 163	32,90
790501044	MBVM2-14,7	matrijs	14,7	50638 02 165	32,90
790501046	MBVM2-15,2	matrijs	15,2	50638 02 167	32,90
790501048	MBVM2-15,7	matrijs	15,7	50638 02 171	32,90
790501050	MBVM2-16,2	matrijs	16,2	50638 02 173	32,90
790501052	MBVM2-16,7	matrijs	16,7	50638 02 175	32,90
790501054	MBVM2-17,2	matrijs	17,2	50638 02 177	32,90
790501056	MBVM2-17,7	matrijs	17,7	50638 02 181	32,90
790501058	MBVM2-18,2	matrijs	18,2	50638 02 183	32,90
790501060	MBVM2-18,7	matrijs	18,7	50638 02 185	32,90
790501062	MBVM2-19,2	matrijs	19,2	50638 02 187	32,90
790501064	MBVM2-19,7	matrijs	19,7	50638 02 191	32,90
790501066	MBVM2-20,2	matrijs	20,2	50638 02 193	32,90
790501068	MBVM2-20,7	matrijs	20,7	50638 02 195	32,90
790501070	MBVM2-21,2	matrijs	21,2	50638 02 197	32,90
790501072	MBVM2-21,7	matrijs	21,7	50638 02 201	32,90
790501074	MBVM2-22,2	matrijs	22,2	50638 02 203	32,90

Mubea for METALWORKS



Mubea ovale ponsen en matrijzen Gr. 1 en Gr. 2.

De afmetingen van het gat dat u wenst te ponsen wordt bepaald door de pons afmetingen. De ponsen worden aangeduid met deze afmeting.

De matrijsopening moet wijder zijn dan de speling (= tweemaal de snij opening). Volgens onze ervaring bedraagt de speling ongeveer 10% van de materiaaldikte.

De matrijs aanduiding toont de actuele afmetingen van de snij opening (opening van de matrijs).

Grondregels:

1. Wanneer u de speling bepaalt, raden wij u aan de volgende regels te volgen:

Voor ovale ponsen:

Materiaaldikte tot 6mm, spelling 0,3mm

Materiaaldikte tot 6 tot 14mm, spelling 1,0mm

Bvb.:

- Ponsdiameter: 11 x 30 mm
- Materiaaldikte: van 1 tot 6 mm
- Matrijsopening: 11,3 x 30,3 mm
- Materiaaldikte: boven 6 mm
- Matrijsopening: 12 x 31 mm

2. Verzekeer u ervan dat de speling altijd in lijn staat tussen pons en matrijs opening.

3. Bij ovale ponsen dient u steeds de veiligheidsspin te gebruiken voor een correcte centrering.

4. De matrijs, pons houder en reducties dienen veilig bevestigd te worden in hun supports.

5. De afstrijker of neerhouder moeten in overeenstemming handelen en worden uitgelijnd met de oppervlakte van de matrijs

6. Om de hoogst mogelijke levensduur van uw pons te bekomen, dient u de ponsen frequent te smeren, tijdens het ponsen.

7. Om uw ponsknipmachine niet te overbelasten, raden wij u aan rekening te houden met de max. ponscapaciteit aangegeven op de prestatieplaat.

Diameter x materiaaldikte x materiaal trekstrekke (tot 600 N/mm², kunt u de factor 0,8 gebruiken)

De ovale matrijzen Gr.1 kunnen enkel gebruikt worden door gebruikt te maken van de volgende matrijsreducties 790504032 en 790504034; Gr.2 enkel door 790504036.

Order nr.	Orig. nr.	Omschrijving	Ovaal	Mubea nr	Prijs
			mm		
790402002	MBOP2-5,0X10	pons	5,0x10	50505 23 001	41,30
790402004	MBOP2-5,0X13	pons	5,0x13	50505 23 002	41,30
790402006	MBOP2-5,0X15	pons	5,0x15	50505 23 003	41,30
790402008	MBOP2-5,0X20	pons	5,0x20	50505 23 004	41,30
790402010	MBOP2-5,0X25	pons	5,0x25	50505 23 005	41,30
790402012	MBOP2-5,5X11	pons	5,5x11	50505 23 019	41,30
790402014	MBOP2-5,5X13	pons	5,5x13	50505 23 020	41,30
790402016	MBOP2-5,5X15	pons	5,5x15	50505 23 021	41,30
790402018	MBOP2-5,5X20	pons	5,5x20	50505 23 022	41,30
790402020	MBOP2-5,5X25	pons	5,5x25	50505 23 023	41,30
790402022	MBOP2-6,5X13	pons	6,5x13	50505 23 037	41,30
790402024	MBOP2-6,5X15	pons	6,5x15	50505 23 038	41,30
790402026	MBOP2-6,5X20	pons	6,5x20	50505 23 039	41,30
790402028	MBOP2-6,5X25	pons	6,5x25	50505 23 040	41,30
790402030	MBOP2-6,5X30	pons	6,5x30	50505 23 041	41,30
790402032	MBOP2-7,0X15	pons	7,0x15	50505 23 055	41,30
790402034	MBOP2-7,0X20	pons	7,0x20	50505 23 056	41,30
790402036	MBOP2-7,0X25	pons	7,0x25	50505 23 057	41,30
790402038	MBOP2-7,0X30	pons	7,0x30	50505 23 058	41,30
790402040	MBOP2-8,0X13	pons	8,0x13	50505 23 070	41,30
790402042	MBOP2-8,0X16	pons	8,0x16	50505 23 071	41,30
790402044	MBOP2-8,0X20	pons	8,0x20	50505 23 072	41,30
790402046	MBOP2-8,0X25	pons	8,0x25	50505 23 073	41,30
790402048	MBOP2-8,0X30	pons	8,0x30	50505 23 074	41,30
790402050	MBOP2-9,0X13	pons	9,0x13	50505 23 088	41,30
790402052	MBOP2-9,0X18	pons	9,0x18	50505 23 089	41,30
790402054	MBOP2-9,0X20	pons	9,0x20	50505 23 090	41,30
790402056	MBOP2-9,0X25	pons	9,0x25	50505 23 091	41,30
790402058	MBOP2-9,0X30	pons	9,0x30	50505 23 092	41,30
790402060	MBOP2-9,5X13	pons	9,5x13	50505 23 107	41,30
790402062	MBOP2-9,5X15	pons	9,5x15	50505 23 108	41,30
790402064	MBOP2-9,5X20	pons	9,5x20	50505 23 109	41,30
790402066	MBOP2-9,5X25	pons	9,5x25	50505 23 110	41,30
790402068	MBOP2-9,5X30	pons	9,5x30	50505 23 111	41,30
790402070	MBOP2-10,5X15	pons	10,5x15	50505 23 125	41,30
790402072	MBOP2-10,5X21	pons	10,5x21	50505 23 126	41,30
790402074	MBOP2-10,5X25	pons	10,5x25	50505 23 127	41,30
790402076	MBOP2-10,5X30	pons	10,5x30	50505 23 128	41,30
790402078	MBOP2-11,0X15	pons	11,0x15	50505 23 140	41,30
790402080	MBOP2-11,0X20	pons	11,0x20	50505 23 141	41,30
790402082	MBOP2-11,0X25	pons	11,0x25	50505 23 142	41,30
790402084	MBOP2-11,0X30	pons	11,0x30	50505 23 143	41,30
790402086	MBOP2-12,0X20	pons	12,0x20	50505 23 167	41,30
790402088	MBOP2-12,0X25	pons	12,0x25	50505 23 168	41,30
790402090	MBOP2-12,0X30	pons	12,0x30	50505 23 169	41,30
790402092	MBOP2-13,0X20	pons	13,0x20	50505 23 179	41,30
790402094	MBOP2-13,0X25	pons	13,0x25	50505 23 180	41,30
790402096	MBOP2-13,0X30	pons	13,0x30	50505 23 181	41,30
790402098	MBOP2-13,5X20	pons	13,5x20	50505 23 191	41,30
790402100	MBOP2-13,5X25	pons	13,5x25	50505 23 192	41,30
790402102	MBOP2-13,5X30	pons	13,5x30	50505 23 193	41,30
790402104	MBOP2-14,0X20	pons	14,0x20	50505 23 215	41,30
790402106	MBOP2-14,0X25	pons	14,0x25	50505 23 216	41,30
790402108	MBOP2-14,0X30	pons	14,0x30	50505 23 217	41,30
790402110	MBOP2-16,0X25	pons	16,0x25	50505 23 233	41,30
790402112	MBOP2-16,0X30	pons	16,0x30	50505 23 234	41,30
790402114	MBOP2-17,5X25	pons	17,5x25	50505 23 248	41,30
790402116	MBOP2-17,5X30	pons	17,5x30	50505 23 249	41,30
790402118	MBOP2-18,0X30	pons	18,0x30	50505 23 255	41,30
790402120	MBOP2-19,0X25	pons	19,0x25	50505 23 266	41,30
790402122	MBOP2-19,0X30	pons	19,0x30	50505 23 267	41,30
790402124	MBOP2-20,5X25	pons	20,5x25	50505 23 281	41,30
790402126	MBOP2-20,5X30	pons	20,5x30	50505 23 282	41,30
790402128	MBOP2-22,0X30	pons	22,0x30	50505 23 288	41,30
790402130	MBOP2-22,5X30	pons	22,5x30	50505 23 301	41,30
790402132	MBOP2-24,0X30	pons	24,0x30	50505 23 316	41,30
790402134	MBOP2-25,5X30	pons	25,5x30	50505 23 328	41,30
790502002	MBOM1-5,3X10,3	matrijs	5,3x10,3	50633 03 007	27,70

Order nr.	Orig. nr.	Omschrijving	Ovaal mm	Mubea nr	Prijs €
790502004	MBOM1-5,3X13,3	matrijs	5,3x13,3	50633 03 008	27,70
790502006	MBOM1-5,3X15,3	matrijs	5,3x15,3	50633 03 009	27,70
790502008	MBOM1-5,8X11,3	matrijs	5,8x11,3	50633 03 025	27,70
790502010	MBOM1-5,8X13,3	matrijs	5,8x13,3	50633 03 026	27,70
790502012	MBOM1-5,8X15,3	matrijs	5,8x15,3	50633 03 027	27,70
790502014	MBOM1-6,0X11,0	matrijs	6,0x11,0	50633 03 013	27,70
790502016	MBOM1-6,0X14,0	matrijs	6,0x14,0	50633 03 014	27,70
790502018	MBOM1-6,0X16,0	matrijs	6,0x16,0	50633 03 015	27,70
790502020	MBOM1-6,5X12,0	matrijs	6,5x12,0	50633 03 031	27,70
790502022	MBOM1-6,5X14,0	matrijs	6,5x14,0	50633 03 032	27,70
790502024	MBOM1-6,5X16,0	matrijs	6,5x16,0	50633 03 033	27,70
790502026	MBOM1-6,8X13,3	matrijs	6,8x13,3	50633 03 043	27,70
790502028	MBOM1-6,8X15,3	matrijs	6,8x15,3	50633 03 044	27,70
790502030	MBOM1-7,3X15,3	matrijs	7,3x15,3	50633 03 060	27,70
790502032	MBOM1-7,5X14,0	matrijs	7,5x14,0	50633 03 049	27,70
790502034	MBOM1-7,5X16,0	matrijs	7,5x16,0	50633 03 050	27,70
790502036	MBOM1-8,0X16,0	matrijs	8,0x16,0	50633 03 071	27,70
790502038	MBOM1-8,3X13,3	matrijs	8,3x13,3	50633 03 076	27,70
790502040	MBOM1-9,0X14,0	matrijs	9,0x14,0	50633 03 082	27,70
790502042	MBOM1-9,3X13,3	matrijs	9,3x13,3	50633 03 094	27,70
790502044	MBOM1-9,8X13,3	matrijs	9,8x13,3	50633 03 113	27,70
790502046	MBOM1-9,8X15,3	matrijs	9,8x15,3	50633 03 114	27,70
790502048	MBOM1-10,0X14,0	matrijs	10,0x14,0	50633 03 101	27,70
790502050	MBOM1-10,5X14,0	matrijs	10,5x14,0	50633 03 119	27,70
790502052	MBOM1-10,5X16,0	matrijs	10,5x16,0	50633 03 120	27,70
790502054	MBOM1-10,8X15,3	matrijs	10,8x15,3	50633 03 130	27,70
790502056	MBOM1-11,3X15,3	matrijs	11,3x15,3	50633 03 149	27,70
790502058	MBOM1-11,5X16,0	matrijs	11,5x16,0	50633 03 135	27,70
790502060	MBOM1-12,0X16,0	matrijs	12,0x16,0	50633 03 158	27,70
790502062	MBOM2-5,3X20,3	matrijs	5,3x20,3	50638 03 010	37,80
790502064	MBOM2-5,3X25,3	matrijs	5,3x25,3	50638 03 011	37,80
790502066	MBOM2-5,8X20,3	matrijs	5,8x20,3	50638 03 028	37,80
790502068	MBOM2-5,8X25,3	matrijs	5,8x25,3	50638 03 029	37,80
790502070	MBOM2-6,0X21,0	matrijs	6,0x21,0	50638 03 016	37,80
790502072	MBOM2-6,0X26,0	matrijs	6,0x26,0	50638 03 017	37,80
790502074	MBOM2-6,5X21,0	matrijs	6,5x21,0	50638 03 034	37,80
790502076	MBOM2-6,5X26,0	matrijs	6,5x26,0	50638 03 035	37,80
790502078	MBOM2-6,8X20,3	matrijs	6,8x20,3	50638 03 045	37,80
790502080	MBOM2-6,8X25,3	matrijs	6,8x25,3	50638 03 046	37,80
790502082	MBOM2-6,8X30,3	matrijs	6,8x30,3	50638 03 047	37,80
790502084	MBOM2-7,3X20,3	matrijs	7,3x20,3	50638 03 061	37,80
790502086	MBOM2-7,3X25,3	matrijs	7,3x25,3	50638 03 062	37,80
790502088	MBOM2-7,3X30,3	matrijs	7,3x30,3	50638 03 063	37,80
790502090	MBOM2-7,5X21,0	matrijs	7,5x21,0	50638 03 051	37,80
790502092	MBOM2-7,5X26,0	matrijs	7,5x26,0	50638 03 052	37,80
790502094	MBOM2-7,5X31,0	matrijs	7,5x31,0	50638 03 053	37,80
790502096	MBOM2-8,0X21,0	matrijs	8,0x21,0	50638 03 066	37,80
790502098	MBOM2-8,0X26,0	matrijs	8,0x26,0	50638 03 067	37,80
790502100	MBOM2-8,0X31,0	matrijs	8,0x31,0	50638 03 068	37,80
790502102	MBOM2-8,3X16,3	matrijs	8,3x16,3	50638 03 077	37,80
790502104	MBOM2-8,3X20,3	matrijs	8,3x20,3	50638 03 078	37,80
790502106	MBOM2-8,3X25,3	matrijs	8,3x25,3	50638 03 079	37,80
790502108	MBOM2-8,3X30,3	matrijs	8,3x30,3	50638 03 080	37,80
790502110	MBOM2-9,0X17,0	matrijs	9,0x17,0	50638 03 083	37,80
790502112	MBOM2-9,0X21,0	matrijs	9,0x21,0	50638 03 084	37,80
790502114	MBOM2-9,0X26,0	matrijs	9,0x26,0	50638 03 085	37,80
790502116	MBOM2-9,0X31,0	matrijs	9,0x31,0	50638 03 086	37,80
790502118	MBOM2-9,3X18,3	matrijs	9,3x18,3	50638 03 095	37,80
790502120	MBOM2-9,3X20,3	matrijs	9,3x20,3	50638 03 096	37,80
790502122	MBOM2-9,3X25,3	matrijs	9,3x25,3	50638 03 097	37,80
790502124	MBOM2-9,3X30,3	matrijs	9,3x30,3	50638 03 098	37,80
790502126	MBOM2-9,8X20,3	matrijs	9,8x20,3	50638 03 115	37,80
790502128	MBOM2-9,8X25,3	matrijs	9,8x25,3	50638 03 116	37,80
790502130	MBOM2-9,8X30,3	matrijs	9,8x30,3	50638 03 117	37,80
790502132	MBOM2-10,0X19,0	matrijs	10,0x19,0	50638 03 102	37,80
790502134	MBOM2-10,0X21,0	matrijs	10,0x21,0	50638 03 103	37,80
790502136	MBOM2-10,0X26,0	matrijs	10,0x26,0	50638 03 104	37,80
790502138	MBOM2-10,0X31,0	matrijs	10,0x31,0	50638 03 105	37,80

Order nr.	Orig. nr.	Omschrijving	Ovaal mm	Mubea nr	Prijs €
790502140	MBOM2-10,5X21,0	matrijs	10,5x21,0	50638 03 126	37,80
790502142	MBOM2-10,5X26,0	matrijs	10,5x26,0	50638 03 122	37,80
790502144	MBOM2-10,5X31,0	matrijs	10,5x31,0	50638 03 123	37,80
790502146	MBOM2-10,8X21,3	matrijs	10,8x21,3	50638 03 131	37,80
790502148	MBOM2-10,8X25,3	matrijs	10,8x25,3	50638 03 132	37,80
790502150	MBOM2-10,8X30,3	matrijs	10,8x30,3	50638 03 133	37,80
790502152	MBOM2-11,3X20,3	matrijs	11,3x20,3	50638 03 150	37,80
790502154	MBOM2-11,3X25,3	matrijs	11,3x25,3	50638 03 151	37,80
790502156	MBOM2-11,3X30,3	matrijs	11,3x30,3	50638 03 152	37,80
790502158	MBOM2-11,5X22,0	matrijs	11,5x22,0	50638 03 136	37,80
790502160	MBOM2-11,5X26,0	matrijs	11,5x26,0	50638 03 137	37,80
790502162	MBOM2-11,5X31,0	matrijs	11,5x31,0	50638 03 138	37,80
790502164	MBOM2-12,0X21,0	matrijs	12,0x21,0	50638 03 159	37,80
790502166	MBOM2-12,0X26,0	matrijs	12,0x26,0	50638 03 160	37,80
790502168	MBOM2-12,0X31,0	matrijs	12,0x31,0	50638 03 161	37,80
790502170	MBOM2-12,3X20,3	matrijs	12,3x20,3	50638 03 171	37,80
790502172	MBOM2-12,3X25,3	matrijs	12,3x25,3	50638 03 172	37,80
790502174	MBOM2-12,3X30,3	matrijs	12,3x30,3	50638 03 173	37,80
790502176	MBOM2-13,0X21,0	matrijs	13,0x21,0	50638 03 175	37,80
790502178	MBOM2-13,0X26,0	matrijs	13,0x26,0	50638 03 176	37,80
790502180	MBOM2-13,0X31,0	matrijs	13,0x31,0	50638 03 177	37,80
790502182	MBOM2-13,3X20,3	matrijs	13,3x20,3	50638 03 183	37,80
790502184	MBOM2-13,3X25,3	matrijs	13,3x25,3	50638 03 184	37,80
790502186	MBOM2-13,3X30,3	matrijs	13,3x30,3	50638 03 185	37,80
790502188	MBOM2-13,8X20,3	matrijs	13,8x20,3	50638 03 201	37,80
790502190	MBOM2-13,8X25,3	matrijs	13,8x25,3	50638 03 202	37,80
790502192	MBOM2-13,8X30,3	matrijs	13,8x30,3	50638 03 203	37,80
790502194	MBOM2-14,0X21,0	matrijs	14,0x21,0	50638 03 187	37,80
790502196	MBOM2-14,0X26,0	matrijs	14,0x26,0	50638 03 188	37,80
790502198	MBOM2-14,0X31,0	matrijs	14,0x31,0	50638 03 189	37,80
790502200	MBOM2-14,3X20,3	matrijs	14,3x20,3	50638 03 221	37,80
790502202	MBOM2-14,3X25,3	matrijs	14,3x25,3	50638 03 222	37,80
790502204	MBOM2-14,3X30,3	matrijs	14,3x30,3	50638 03 223	37,80
790502206	MBOM2-14,5X21,0	matrijs	14,5x21,0	50638 03 208	37,80
790502208	MBOM2-14,5X26,0	matrijs	14,5x26,0	50638 03 209	37,80
790502210	MBOM2-14,5X31,0	matrijs	14,5x31,0	50638 03 210	37,80
790502212	MBOM2-15,0X21,0	matrijs	15,0x21,0	50638 03 227	37,80
790502214	MBOM2-15,0X26,0	matrijs	15,0x26,0	50638 03 228	37,80
790502216	MBOM2-15,0X31,0	matrijs	15,0x31,0	50638 03 229	37,80
790502218	MBOM2-16,3X25,3	matrijs	16,3x25,3	50638 03 238	37,80
790502220	MBOM2-16,3X30,3	matrijs	16,3x30,3	50638 03 239	37,80
790502222	MBOM2-17,0X26,0	matrijs	17,0x26,0	50638 03 243	37,80
790502224	MBOM2-17,0X31,0	matrijs	17,0x31,0	50638 03 244	37,80
790502226	MBOM2-17,8X25,3	matrijs	17,8x25,3	50638 03 254	37,80
790502228	MBOM2-17,8X30,3	matrijs	17,8x30,3	50638 03 255	37,80
790502230	MBOM2-18,3X30,3	matrijs	18,3x30,3	50638 03 256	37,80
790502232	MBOM2-18,5X26,0	matrijs	18,5x26,0	50638 03 260	37,80
790502234	MBOM2-18,5X31,0	matrijs	18,5x31,0	50638 03 261	37,80
790502236	MBOM2-19,0X31,0	matrijs	19,0x31,0	50638 03 264	37,80
790502238	MBOM2-19,3X25,3	matrijs	19,3x25,3	50638 03 271	37,80
790502240	MBOM2-19,3X30,3	matrijs	19,3x30,3	50638 03 272	37,80
790502242	MBOM2-20,0X26,0	matrijs	20,0x26,0	50638 03 276	37,80
790502244	MBOM2-20,0X31,0	matrijs	20,0x31,0	50638 03 277	37,80
790502246	MBOM2-20,8X25,3	matrijs	20,8x25,3	50638 03 287	37,80
790502248	MBOM2-20,8X30,3	matrijs	20,8x30,3	50638 03 288	37,80
790502250	MBOM2-21,5X26,0	matrijs	21,5x26,0	50638 03 293	37,80
790502252	MBOM2-21,5X31,0	matrijs	21,5x31,0	50638 03 294	37,80
790502254	MBOM2-22,3X30,3	matrijs	22,3x30,3	50638 03 295	37,80
790502256	MBOM2-22,8X30,3	matrijs	22,8x30,3	50638 03 306	37,80
790502258	MBOM2-23,0X31,0	matrijs	23,0x31,0	50638 03 308	37,80
790502260	MBOM2-23,5X31,0	matrijs	23,5x31,0	50638 03 311	37,80
790502262	MBOM2-24,3X30,3	matrijs	24,3x30,3	50638 03 320	37,80
790502264	MBOM2-25,0X31,0	matrijs	25,0x31,0	50638 03 324	37,80
790502266	MBOM2-25,8X30,3	matrijs	25,8x30,3	50638 03 332	37,80
790502268	MBOM2-26,5X31,0	matrijs	26,5x31,0	50638 03 336	37,80

Mubea for METALWORKS

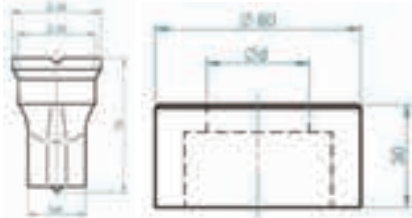

Mubea ovale ponsen en matrijzen Gr. 3.

De afmetingen van het gat dat u wenst te ponsen wordt bepaald door de pons afmetingen. De ponsen worden aangeduid met deze afmeting.

De matrijsopening moet wijder zijn dan de speling (= tweemaal de snij opening). Volgens onze ervaring bedraagt de speling ongeveer 10% van de materiaaldikte.

De matrijs aanduiding toont de actuele afmetingen van de snij opening (opening van de matrijs).

Grondregels:

1. Wanneer u de speling bepaalt, raden wij u aan de volgende regels te volgen:

Voor ovale ponsen:

Materiaaldikte tot 6mm, spelling 0,3mm

Materiaaldikte tot 6 tot 14mm, spelling 1,0mm

Bvb.:

- Ponsdiameter : 11 x 30 mm

- Materiaaldikte : van 1 tot 6 mm

- Matrijsopening : 11,3 x 30,3 mm

- Materiaaldikte : boven 6 mm

- Matrijsopening : 12 x 31 mm

2. Verzeker u ervan dat de speling altijd in lijn staat tussen pons en matrijs opening.

3. Bij ovale ponsen dient u steeds de veiligheidspin te gebruiken voor een correcte centering.

4. De matrijs, ponshouder en reducties dienen veilig bevestigd te worden in hun supports.

5. De afstrijder of neerhouder moeten in overeenstemming handelen en worden uitgelijnd met de oppervlakte van de matrijs

6. Om de hoogst mogelijke levensduur van uw pons te bekomen, dient u de ponsen frequent te smeren, tijdens het ponsen.

7. Om uw ponsknipmachine niet te overbelasten, raden wij u aan rekening te houden met de max. ponscapaciteit aangegeven op de prestatieplaat.

Diameter x materiaaldikte x materiaal trekstrekke (tot 600 N/mm², kunt u de factor 0,8 gebruiken)

Enkel te gebruiken bij Mubea pons/knipmachines uitgerust met de speciale ponsenheid, die ponsen van ø 30,5 tot 50 mm kan opnemen. Of andere merken die standaard tot ø 40 mm kunnen opnemen.

Order nr.	Orig. nr.	Om-schrij-ving	Ovaal mm	Mubea nr	Prijs
790402136	MBOP3-11,0X35	pons	11,0x35	50505 33 144	54,80
790402138	MBOP3-11,0X40	pons	11,0x40	50505 33 145	54,80
790402140	MBOP3-13,5X35	pons	13,5x35	50505 33 194	54,80
790402142	MBOP3-13,5X40	pons	13,5x40	50505 33 195	54,80
790402144	MBOP3-14,0X35	pons	14,0x35	50505 33 218	54,80
790402146	MBOP3-14,0X40	pons	14,0x40	50505 33 219	54,80
790402148	MBOP3-16,0X35	pons	16,0x35	50505 33 235	54,80
790402150	MBOP3-16,0X40	pons	16,0x40	50505 33 326	54,80
790402152	MBOP3-17,5X35	pons	17,5x35	50505 33 250	54,80
790402154	MBOP3-17,5X40	pons	17,5x40	50505 33 251	54,80
790402156	MBOP3-19,0X35	pons	19,0x35	50505 33 268	54,80
790402158	MBOP3-19,0X40	pons	19,0x40	50505 33 269	54,80
790402160	MBOP3-20,5X35	pons	20,5x35	50505 33 283	54,80
790402162	MBOP3-20,5X40	pons	20,5x40	50505 33 284	54,80
790402164	MBOP3-22,5X35	pons	22,5x35	50505 33 302	54,80
790402166	MBOP3-22,5X40	pons	22,5x40	50505 33 303	54,80
790402168	MBOP3-24,0X40	pons	24,0x40	50505 33 317	54,80
790402170	MBOP3-25,5X40	pons	25,5x40	50505 33 329	54,80
790402172	MBOP3-26,0X40	pons	26,0x40	50505 33 340	54,80
790402174	MBOP3-27,0X40	pons	27,0x40	50505 33 349	54,80
790502270	MBOM3-11,3X35,3	matrijs	11,3x35,3	50639 03 153	51,90
790502272	MBOM3-11,3X40,3	matrijs	11,3x40,3	50639 03 154	51,90
790502274	MBOM3-12,0x36,0	matrijs	12,0x36,0	50639 03 162	51,90
790502276	MBOM3-12,0X41,0	matrijs	12,0x41,0	50639 03 163	51,90
790502278	MBOM3-13,8X35,3	matrijs	13,8x35,3	50639 03 204	51,90
790502280	MBOM3-13,8X40,3	matrijs	13,8x40,3	50639 03 205	51,90
790502282	MBOM3-14,3X35,3	matrijs	14,3x35,3	50639 03 224	51,90
790502284	MBOM3-14,3X40,3	matrijs	14,3x40,3	50639 03 225	51,90
790502286	MBOM3-14,5X36,0	matrijs	14,5x36,0	50639 03 211	51,90
790502288	MBOM3-14,5X41,0	matrijs	14,5x41,0	50639 03 212	51,90
790502290	MBOM3-15,0X36,0	matrijs	15,0x36,0	50639 03 230	51,90
790502292	MBOM3-15,0X41,0	matrijs	15,0x41,0	50639 03 231	51,90
790502294	MBOM3-16,3X35,3	matrijs	16,3x35,3	50639 03 240	51,90
790502296	MBOM3-16,3X40,3	matrijs	16,3x40,3	50639 03 241	51,90
790502298	MBOM3-17,0X36,0	matrijs	17,0x36,0	50639 03 245	51,90
790502300	MBOM3-17,0X41,0	matrijs	17,0x41,0	50639 03 246	51,90
790502302	MBOM3-17,8X35,3	matrijs	17,8x35,3	50639 03 256	51,90
790502304	MBOM3-17,8X40,3	matrijs	17,8x40,3	50639 03 257	51,90
790502306	MBOM3-18,5X36,0	matrijs	18,5x36,0	50639 03 262	51,90
790502308	MBOM3-18,5X41,0	matrijs	18,5x41,0	50639 03 263	51,90
790502310	MBOM3-19,3X35,3	matrijs	19,3x35,3	50639 03 273	51,90
790502312	MBOM3-19,3X40,3	matrijs	19,3x40,3	50639 03 274	51,90
790502314	MBOM3-20,0X36,0	matrijs	20,0x36,0	50639 03 278	51,90
790502316	MBOM3-20,0X41,0	matrijs	20,0x41,0	50639 03 279	51,90
790502318	MBOM3-20,8X35,3	matrijs	20,8x35,3	50639 03 289	51,90
790502320	MBOM3-20,8X40,3	matrijs	20,8x40,3	50639 03 290	51,90
790502322	MBOM3-21,5X36,0	matrijs	21,5x36,0	50639 03 295	51,90
790502324	MBOM3-21,5X41,0	matrijs	21,5x41,0	50639 03 296	51,90
790502326	MBOM3-22,8X35,3	matrijs	22,8x35,3	50639 03 307	51,90
790502328	MBOM3-22,8X40,3	matrijs	22,8x40,3	50639 03 308	51,90
790502330	MBOM3-23,5X36,0	matrijs	23,5x36,0	50639 03 312	51,90
790502332	MBOM3-23,5X41,0	matrijs	23,5x41,0	50639 03 313	51,90
790502334	MBOM3-24,3X40,3	matrijs	24,3x40,3	50638 03 028	51,90
790502336	MBOM3-25,0X41,0	matrijs	25,0x41,0	50639 03 325	51,90
790502338	MBOM3-25,8X40,3	matrijs	25,8x40,3	50639 03 333	51,90
790502340	MBOM3-26,3X40,3	matrijs	26,3x40,3	50639 03 343	51,90
790502342	MBOM3-26,5X41,0	matrijs	26,5x41,0	50639 03 337	51,90
790502344	MBOM3-27,0X41,0	matrijs	27,0x41,0	50639 03 346	51,90
790502346	MBOM3-27,3X40,3	matrijs	27,3x40,3	50639 03 352	51,90
790502348	MBOM3-28,0X41,0	matrijs	28,0x41,0	50639 03 355	51,90

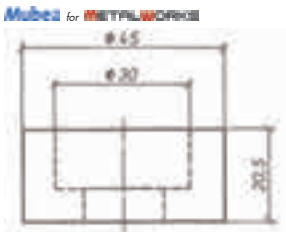

Mubea matrijsreductie MBN50606-1.

Order nr.	790504032
Orig. nr.	MBMR1
Buitendiameter	mm 45
Binnendiameter	mm 20
Prijs	€

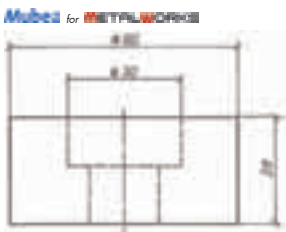

Mubea matrijsreductie MBN50606-2.

Order nr.	790504034
Orig. nr.	MBMR2
Buitendiameter	mm 60
Binnendiameter	mm 20
Prijs	€

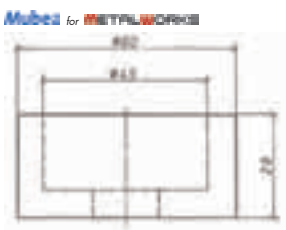

Mubea matrijsreductie MBN50606-3.

Order nr.	790504036
Orig. nr.	MBMR3
Buitendiameter	mm 60
Binnendiameter	mm 45
Prijs	€

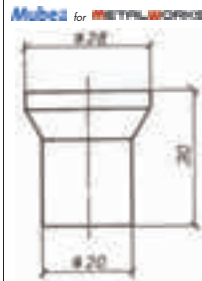

Mubea ponsreductie inzet. Opvuller Mubea MBN50529 voor Mubea ponsen MBN50505-1, MBP1, van \varnothing 3 tot 15 mm. Dient gebruikt te worden met ponsreducties 790504022, 790504024 en 790504026.

Order nr.	79050402 ##
Orig. nr.	MBPRI
Prijs	€

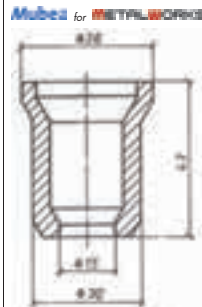

Mubea reductie MBN50531-3 voor ponsen MBN50505-1, MBP1, van \varnothing 3 tot 15 mm. Voor snelspansysteem Mubea en wartelmoer M42.

Order nr.	790504022
Orig. nr.	MBPR1
Prijs	€

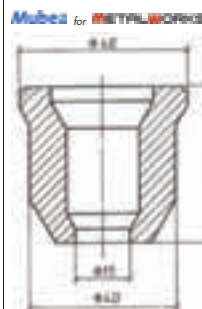

Mubea reductie MBN50531-4 voor ponsen MBN50505-1, MBP1, van \varnothing 3 tot 15 mm. Voor snelspansysteem Mubea en wartelmoer M52.

Order nr.	790504024
Orig. nr.	MBPR2
Prijs	€

Mubea for METALWORKS

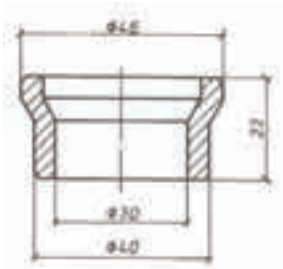

NEW

Mubea reductie MBN50531-5 voor ponsen MBN50505-2, MBP2, MBVP2 en MBOP2, van \varnothing 15,5 tot 30 mm. Voor snelspansysteem Mubea en wartelmoer M52.

Order nr.	790504026
Orig. nr.	MBPR3
Prijs	€

Mubea for METALWORKS

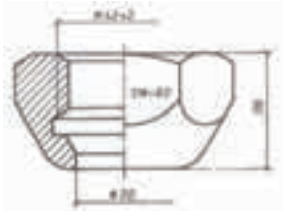

NEW

Wartelmoer M42 voor Mubea ponsen MBN50505-2, MBP2, MBVP2, MBOP2; voor ponsen met diameter \varnothing 36 mm, \varnothing 15,5 tot 30 mm.

Order nr.	790504002
Orig. nr.	MBWM4230
Schroefdraad	M 42x2
Diameter	mm 30
Prijs	€

Mubea for METALWORKS

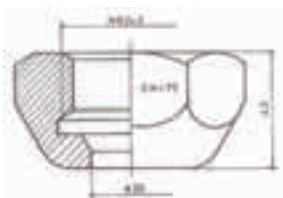

NEW

Wartelmoer M52 voor Mubea ponsen MBN50505-2, MBP2, MBVP2, MBOP2; voor ponsen met diameter \varnothing 36 mm, \varnothing 15,5 tot 30 mm.

Order nr.	790504004
Orig. nr.	MBWM5230
Schroefdraad	M 52x2
Diameter	mm 30
Prijs	€

Mubea for METALWORKS

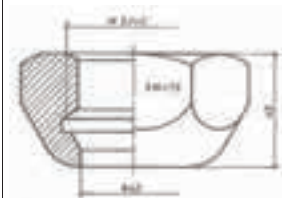

NEW

Wartelmoer M52 voor Mubea ponsen MBN50505-3, MBP3, MBVP3, MBOP3; voor ponsen met diameter \varnothing 46 mm, \varnothing 30,5 tot 40 mm.

Order nr.	790504006
Orig. nr.	MBWM5240
Schroefdraad	M 52x2
Diameter	mm 40
Prijs	€



Mubea *for* **METALWORKS**



OPTIMUM®

OPTI^{turn} OPTI^{saw} OPTI^{mill} OPTI^{grind} OPTI^{drill} OPTI^{chuck}

QUALITY AT AN ECONOMICAL PRICE OPTIMUM® METAL WORKING MACHINES

Optimum has been developing and designing metal-working for more than 15 years. Optimum distinguish themselves by quality, accuracy, durability and consistent value. They are developed in a high degree. Beside the own production plants, Optimum is produced together with manufacturers who can comply with the high quality requirements. The knowledge serves the constant development and improvement of the Optimum products.

The Optimum machines are supervised from the beginning of the development to the serial production and up

to the after-sales service. This results in a high quality standard.

The products

You're looking for a functional machine offering comprehensive performance features at an optimum value? Then you make the right decision by purchasing Optimum metal working machines. Our machines are convincing by outstanding quality, precision manufacturing and are offering an "Optimum" in price and performance.

THE OPTIMUM® QUALITY GUARANTEE
ALL OPTIMUM® PRODUCTS ARE PRODUCED
CONSIDERING HIGH QUALITY REQUIREMENTS.





Should you need our after-sales-service, we will be at your disposal with an experienced service team. A comprehensive stock of spare parts which is available provides you with short-time delivery of spare parts, if necessary. Our service guarantees you consistent value of your machine for many years.

OPTIMUM® MASCHINEN - GERMANY

Metal working machines

- | | |
|---------------------------|------------------------------|
| Bench drilling machines | Grinding machines |
| Upright drilling machines | Polishing machines |
| Geared upright drills | Sheet metal working machines |
| Milling machines | Arbor presses |
| Lathes | CNC technology |
| Measuring instruments | Accessories |
| Metal band saws | |
| Metal circular saws | |





Band- en schijfschuurmachines

OPTIUM



Schijfschuurmachine voor metaal- en houtbewerking. Slijptafel kantelbaar van -45 tot +45°. Verstekaanslag instelbaar van -60 tot +60°. Krachtige motor met overspanningsbeveiliging. Standaard met 1 kleefschijf korrel 60. Wij raden het gebruik aan van steun- en klitschijven (velcro) bij vervanging van de schuur schijf.

Order nr.		713310305 M
Orig. nr.		TS305
Spanning	V	230
Vermogen motor	kW	0,9
Diameter schijf	mm	305
Toerental	min-1	1420
Afmetingen tafel (b x d)	mm	155x440
Hoek van tafel	°	+/-45
Uitgang voor afzuiging (diameter)		38
Gewicht	kg	30,00
Afmetingen (l x b x h)	mm	440 x 445 x 365
Prijs	€	229,00

OPTIC



Universele band- en schijfschuurmachine voor metaalbewerking. Tafelmodel met zwenkbare arm. Fijninstelling van de bandspanning voor een trillingsvrije loop. Verstelbare slijptafel en bovenaanslag. Eenvoudige en snelle schuurbandwissel. Veiligheidsschakelaar IP54. Krachtige motor 1100 W. Stofafzuiging aansluitbaar. Standaard met 1 schuurband en schuurschijf korrel 60. Gefabriceerd volgens de CE normen.

Order nr.		713311071
Orig. nr.		DBS75-230V
Spanning	V	230
Vermogen motor	kW	1,1
Afmetingen band	mm	75x1180
Diameter schijf	mm	150
Toerental	min-1	1410
Bandsnelheid	m/sec	11
Afzuigbuis binnen	mm	47
Afzuigbuis buiten	mm	50
Zwenkbereik tafel	°	90
Gewicht	kg	62,00
Afmetingen (l x b x h)	mm	665 x 560 x 405
Prijs	€	679,00

metall-wafl

ACCESSOIRES
p.1104



optionele voet

Professionele, kleine metaal bandschuurmachine.

- Uitstekende prestaties dankzij het 130mm diameter grote drukwiel.
- Hoge bandsnelheid.
- Voor het slijpen van vlakken, boorden en om af te ronden.
- Model 400V met 2 snelheden. Krachtige motor.
- Trillingsvrij dankzij een stabiele constructie.
- Groot horizontaal schuurvlak 300x100mm door wegklapbare schuurband afdekplaat.
- Automatische naspannen van de schuurband door veerondersteund bandspansysteem.
- Zeer snelle bandwissel.
- Wegklapbare oogbescherming
- Door twee monden kan een stofafzuiging gebruikt worden.
- CE Conform.
- Optionele voet leverbaar 713921227.

Order nr.		713921226 ^M	713921221 ^M
Orig. nr.		MBSM101-130	MBSM103-130
Spanning	V	230	3x400
Vermogen motor	kW	1,5	1,5
Schuurbandafmetingen	mm	100x1220	100x1220
Schuurbandsnelheid	m/s	19	9,5/19
Afmetingen drukwiel	mm	100x130	100x130
Maximum schuurvlak	mm	300x100	300x100
Diameter afzuiging	mm	73	73
Gewicht	kg	37,00	37,00
Afmetingen (l x b x h)	mm	690 x 390 x 360	690 x 390 x 360
Prijs	€	399,00	479,00

ACCESSOIRES
p.1104

metalkraft



- 75 x 2000
- 400V
2 snelheden



Metaal bandschuurmachine voor ambacht en industrie.

- Uitstekende prestaties dankzij het grote drukwiel.
- Hoge bandsnelheid.
- Krachtige motor 230V of 3x400V.
- Trillingsvrij dankzij een stabiele constructie.
- Groot horizontaal schuurvlak.
- Zeer snelle bandwissel.
- Ook beschikbaar in schuurband 150x2000 (713922150)
- CE Conform.

Order nr.		713922076 ^M	713922075 ^M
Orig. nr.		MBSM75-200-1	MBSM75-200-2
Spanning	V	230	3x400
Vermogen motor	kW	3	3
Schuurbandafmetingen	mm	75 x 2000	75 x 2000
Schuurbandsnelheid	m/s	14,5	14,5 / 29
Diameter afzuiging	mm	100	100
Diameter drukwiel	mm	200	200
Frequentie	Hz	50	50
Gewicht	kg	72,00	68,00
Afmetingen (l x b x h)	mm	1070 x 340 x 950	1070 x 340 x 950
Prijs	€	699,00	635,00



ACCESSOIRES
p.1104



Buisuitslijpmachine voor diverse metalen buizen en profielen.

- Sterke motor van 3 kW, met 2 snelheden.
- Eenvoudige klemming en efficiënte werking met hefboomhendel.
- Hoekinstelling van 30 tot 90°, voor maten 1/2" tot en met 2 1/2" (slijprollen optioneel).
- Prismabek met aanslag, instelbaar zonder sleutels.
- Gemakkelijke wissel van de schuurband en slijprollen.
- Door de twee zuigmonden kan dit toestel uitgerust worden met een afzuiging 713922000.
- Geleverd met 1 band K40 en 1 slijprol 28mm.

MACHINES

Order nr.	713703078	
Orig. nr.	RPSM2	
Spanning	V	3x400
Vermogen motor	kW	3
Diameter afzuiging	mm	100
Afmetingen band	mm	100x2000
Snelheid band	m/sec	15-30
Slijpbare diameters	mm	20-76
Instelbare slijphoek	°	30-90
Gewicht	kg	168,00
Afmetingen (l x b x h)	mm	1450 x 1150 x 650
Prijs	€	1.949,00

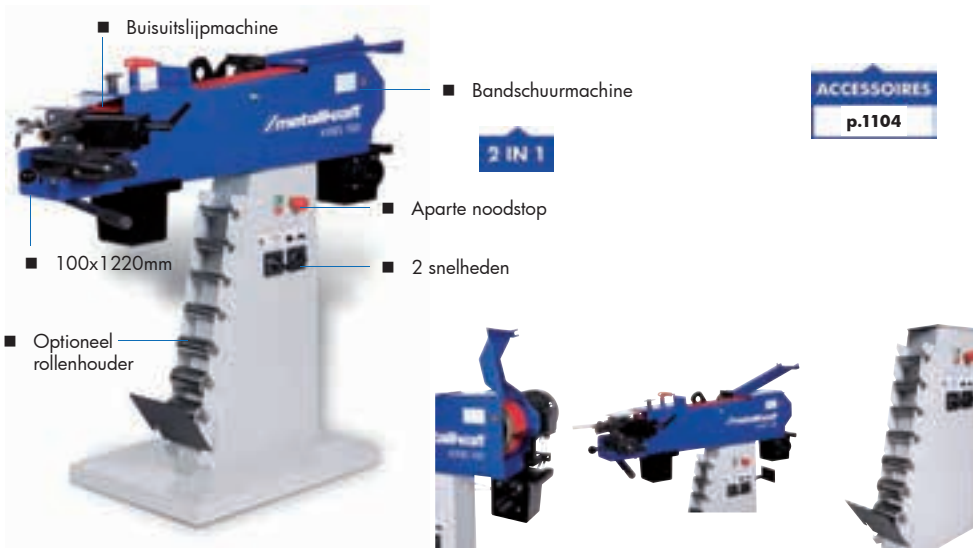

Combinatieslijpmachine voor buizen en klassieke slijpwerkzaamheden.

- De machine heeft 3 bedienvlakken: vooraan voor buizen (met buizenklem), bovenaan voor vlakslijpen en achteraan voor rondslijpen (met werkstuksteun).
- Buisuitslijper: voor diverse metalen buizen en profielen. Hoekinstelling van 30 tot 90°. Aparte slijprollen leverbaar van 20 tot 76mm" (optioneel). Eenvoudige klemming en efficiënte werking met hefboomhendel. Prismabek met aanslag, instelbaar zonder sleutels.
- Sterke motor met 2 snelheden voor verwerken van zowel staal als inox.
- Snel wisselen van draairichting en snelheid met keuzeschakelaars.
- Voorzien van een aparte noodstop en afzonderlijke start / stopknop
- Kan aangesloten worden op een stofafzuiging dankzij de afzuigmond.
- Gemakkelijke wissel van de schuurband en slijprollen.

Standaard met 1 band K36, 1 slijprol 42,4mm en 2 spaanderopvangbakken. voorzien van afzuigaansluiting.

Order nr.		713705100
Orig. nr.		KRBS100
Spanning	V	3x400
Afmetingen band	mm	100x2000
Vermogen motor	kW	2,5-3,3
Snelheid band	m/sec	15-30
Slijpbare diameters	mm	20-76,1
Instelbare slijphoek	°	30-90 (0-60)
Diameter afzuiging	mm	100
Gewicht	kg	159,00
Afmetingen (l x b x h)	mm	1175 x 520 x 1130
Prijs	€	2.290,00

METALWORK



eenvoudige schuurbandwissel d.m.v. hendel

ACCESSOIRES
p.1104



■ 75x2000mm slijpband



■ Krachtige 3kW motor

■ Aparte noodstop

■ In hoogte verstelbaar

Metaal bandschuurmachine.

- Machine voor elke werkplaats of industriële omgeving.
- Voor het slijpen van vlakken en boorden, en om af te ronden.
- Hoge bandsnelheid.
- Met meest voorkomende schuurband op de markt 75x2000
- Voorzien van een noodstop vooraan dicht bij de werkzone van de bediener.
- Met wegklapbare schuurband afdekplaat dat u toelaat om grotere stukken vlak te slijpen
- Stabiele uitvoering.
- Vlugge schuurbandwissel dankzij een wegneembare zijkant
- Voorzien van afzuigkap aan de voorkant en afzuigmond aan de achterkant
- Door de monden kan dit toestel aangesloten worden op een afzuiginstallatie
- Stevige 4pk motor leverbaar in 3x400V en 230V.
- Eenvoudige afregeling van het drukwiel met de regelknop
- Geleverd met voet

MACHINES

Order nr.		800170300 ^M	800170305 ^M
Orig. nr.		BS75200400	BS75200230
Spanning	V	3x400	230
Vermogen motor	kW	3	3
Afmetingen band	mm	75x2000	75x2000
Bandsnelheid	m/sec	29	29
Slijpbreedte	mm	75	75
Diameter drukwiel	mm	200	200
Diameter afzuiging (achter)	mm	100	100
Toerental	tpm	2840	2840
Geluidsniveau - LWA	dB(A)	85	85
Geluidsniveau - LPA	dB(A)	100,3	100,3
Gewicht	kg	75,00	75,00
Afmetingen (l x b x h)	mm	700 x 490 x 1130	700 x 490 x 1130
Prijs	€	599,00	599,00

indicatieve verkoopprijzen in € excl. BTW



Borenslijpmachines



Handige boorslijper. Perfect voor het slijpen van spiraalboren uit HSS of hardmetaal.

- Eenvoudige bediening voor nauwkeurig en kostenefficiënt slijpen van spiraalboren - Boorslijpen zonder voorkennis
- Netjes, snel en goed
- Gemakkelijk transporteerbaar
- Duurzame diamant slijpsteen voor perfect slijpen
- Volledige uitrusting met ER spantangen binnen de machine
- De snijkanten van de boor worden in de spantang in een bepaalde positie opgespannen, en in de slijpopeningen ingezet in een vooraf bepaalde volgorde, zodat de snijkanten door kleine rotatiebewegingen van de spantanghouder geslepen worden.

Diamantschijven zijn eveneens apart verkrijgbaar.

Standaard geleverd met:

- Spantangen van \varnothing 2 tot 13 mm voor GH10T
- Spantangen ER20 en ER40 \varnothing 3 tot 30 mm voor GH15T
- Nederlandstalige handleiding, opschriften, CE - kenmerk, en CE-attest volgens Machine richtlijn 2006/42/CE, Laagspanningsrichtlijn 2006/95/CE en EMC Richtlijn 2004/108/CE

Order nr.		713100110	713100115
Orig. nr.		GH10T	GH15T
Spanning	V	230V/1Ph -50Hz	230V/1Ph -50Hz
Vermogen motor	kW	0,18	0,45
Boorslijpcapaciteit	mm	2 - 13	3 - 30
Traploos instelbare snelheid	min-1	5.300	5.000
Slijphoek	°	90 - 135	90 - 145
Gewicht	kg	9,50	35,00
Afmetingen (l x b x h)	mm	310 x 180 x 190	450 x 240 x 270
Prijs	€	495,00	1.329,00

OPTIMUM

■ 0,6 kW

■ Variabele toerentalregeling 1400-7600 tpm

■ 2 geleidingsvlakken

■ Hoekinstelling 90° - 150°

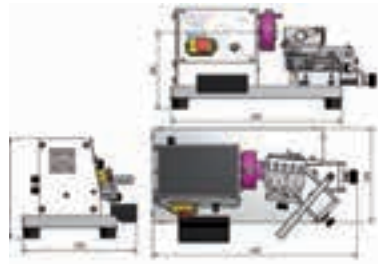
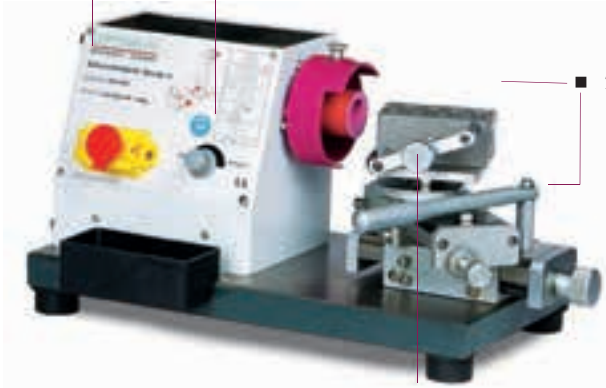

Borenslijpparaat met traploze toerentalregeling.



- Groot slijpbereik boren van 3-20 mm cilindrische boren.
- Zware gietijzeren voet voor een trillingsvrije loop.
- Nauwkeurig centreren van het werkstuk.
- Exacte herhalingsnauwkeurigheid via de prismageleide voedingstafel.
- Magneetschakelaar met een noodstop.
- Niet geschikt voor HM boren of steenboren, tenzij het plaatsen van een slijpsteen 713107121. Gewone steen 713107120.

Order nr.		713100020 
Orig. nr.		DG20
Spanning	V	230
Vermogen motor	kW	0,6
Toerental	min-1	1400-7600
Slijpsnelheid	m/s	16
Hoek puntslijpen	°	90-150
Boorslijpcapaciteit	mm	3-20
Buitendiameter	mm	40
Binnendiameter	mm	26
Draaddiameter	M	10
Diepte	mm	22
Gewicht	kg	26,00
Afmetingen (l x b x h)	mm	490 x 270 x 235
Prijs	€	699,00



Slijpstenen voor Optimum borenslijpmachine DG20

- Rooskleurige slijpsteen (standaard slijpsteen) voor het bewerken van HSS
- Groendkleurige slijpsteen voor het bewerken van hard metaal

Order nr.	713107120 	713107121 
Orig. nr.	3107120	3107121
Prijs	20,50	10,50



■ 0.37 kW

■ Machineverlichting

■ Indexkop 24 posities

■ Diamantschijf

GH20T

Universele slijpmachine voor beitels en werktuigen met verschillende geometriën

Overtuigende argumenten: kwaliteit, efficiëntie en prijs:

- Universeel toepasbaar door veelzijdig zwenken en instellingsopties
- Voor het slijpen van stempels, spiraalboren, elektroden, draaibank gereedschap, centerpunten, enz.
- Hoge precisie dankzij robuuste machinebehuizing en trillingsvrije precisie slijpspindel
- Eenvoudige behandeling en bediening
- Index kop met 24 vergrendelingsposities
- Inclusief 5 spantangen:
 - GH20TB: **355E S20X2**
 - GH20T: **5C**
- Verstelbaar extractietoestel
- Inclusief halogeenverlichting

NEW

BEKIJK DE VIDEO



Korund en diamantschijven zijn eveneens apart verkrijgbaar, 713100128 en 713100129

Standaard geleverd met:

- 5 x Spantangen \varnothing 4, 6, 8, 10 en 12 mm
- Korund slijpschijf \varnothing 100x50x \varnothing 20 mm
- Diamant slijpschijf \varnothing 100x50x \varnothing 20 mm
- Africhter
- Bedieningssleutels
- Nederlandstalige handleiding, opschriften, CE - kenmerk, en CE-attest volgens Machine richtlijn 2006/42/CE, Laagspanningsrichtlijn 2006/95/CE en EMC Richtlijn 2004/108/CE.

Order nr.		713100121 ^M	713100125 ^M
Orig. nr.		GH20TB	GH20T
Spanning	V	1x230	3x400
Vermogen motor	kW	0,25	0,37
Toerental diamantschijf	min-1	5000	5000
Slijpsnelheid	m/s	max.35	max. 35
Toerental motor	min-1	2750	2750
Verplaatsing werktuighouder	mm	140	140
Fijn afstelling werktuighouder	mm	18	18
Fijn afstelling langs	mm	6	6
Verticaal / rugzijde	°	0-40	0-40
Horizontaal / kegelslijpen	°	0-180	0-180
Negatieve hoek	°	0-52	0-52
Vergrendelstand draaihoek	°	15-180	15-180
Spanbereik	mm	1-12	1-16
Spantangtype		355E S20x2	5C
Gewicht	kg	45,00	45,00
Afmetingen (l x b x h)	mm	350 x 450 x 350	350 x 450 x 350
Prijs	€	790,00	995,00



Slijpmachines

OPTI



QSM200

■ Inclusief slijpsteen

■ Alu gietijzeren behuiz-

ACCESSOIRES

p.1105

Dubbele slijpmachine, met uitstekende prijs-prestatieverhouding.

- Behuizing in gietaluminium
- Gebouwd voor professionele bewerking van metalen.
- Onderhoudsvrije motoren, en kwalitatieve rollagers voor een geluidsarme loop.
- Verstelbare werkstukaanslag.
- Met twee verstelbare oogbeschermlenzen.
- Met trillingsdempende gummivoeten.
- Geleverd met twee slijpstenen, korrel 36 en 80.
- Vervaardigd volgens CE-normen.

Optionele machinevoet (713107100) en wandhouder (713107050) leverbaar.

Order nr.		713101815 ^M	713101817 ^M	713101820 ^M
Orig. nr.		QSM150	QSM175	QSM200
Spanning	V	230	230	230
Slijpsteenafmetingen (diameter x b x asgat)	mm	150x20x16	175x20x32	200x25x32
Toerental	min-1	2850	2850	2850
Vermogen motor	kW	0,45	0,45	0,45
Gewicht	kg	12,00	14,00	16,00
Afmetingen (l x b x h)	mm	410 x 295 x 200	420 x 300 x 220	450 x 330 x 245
Prijs	€	115,00	129,00	139,00

OPTI



SM300

Dubbele slijpmachine, bestemd voor de professioneel gebruik.

- Onderhoudsvrije motor voor continue gebruik.
- Behuizing in gietaluminium.
- Geluidsarme loop.
- Stabiele, verstelbare werkstukaanslag.
- Twee oogbeschermingen.
- Start/stop/Noodstop.
- Vario uitvoering wordt uitgerust met een Europese frequentieomvormer en sokkel.
- SM300 standaard met aparte start, stopknop en aparte noodstop.
- Geleverd met twee slijpstenen, korrel 36 en korrel 80.
- Vervaardigd volgens CE-normen.

■ Inclusief slijpsteen

■ Verstelbaar werkstukaanslag

■ Aparte noodstop



Optionele machinevoet (713107100 en 713107101) en wandhouder (713107050) leverbaar.

Order nr.	Orig. nr.	Spanning	Slijpsteenafmetingen		Toerental	Vermogen motor	Gewicht	Afmetingen (l x b x h)	Prijs
			(diameter x b x asgat)	mm					
713101175 M	SM175	230	175x25x32	2850	0,45	14,20	456 x 220 x 291	149,00	
713101200 M	SM200-230V	230	200x30x32	2850	0,6	16,00	461 x 246 x 310	169,00	
713101203 M	SM200-400V	3x400	200x30x32	2850	0,6	16,00	461 x 246 x 310	189,00	
713010205 M	SM200 VARIO	3x400	200x30x32	800-2850	0,6	21,00	461 x 246 x 310	875,00	
713101253 M	SM250	3x400	250x40x32	2850	1,5	37,00	542 x 304 x 365	257,00	
713010255 M	SM250 VARIO	3x400	250x40x32	800 - 3000	1,5	45,00	542 x 304 x 365	1.485,00	
713101303 M	SM300	3x400	300x50x75	1450	2,2	75,00	770 x 420 x 520	765,00	

voor up-to-date informatie zie online catalogus op www.vynckier.biz

OPTIEM



■ Inclusief slijpstenen

NEW
ACCESSOIRES
p.1105

■ Aparte noodstop
■ Vergrendelbare hoofdschakelaar

■ Inclusief onderstel

Werkbanklijper uitgerust met een aparte noodstop en een aparte hoofdschakelaar, gemonteerd op een sokkel.

- Dubbele slijpmolen, bestemd voor scholen, opleidingcentra en industrie.
- Onderhoudsvrije motor met geluidsarme loop.
- Behuizing in gietaluminium.
- Stabiele en vergrendelbare werkstukaanslag.
- Dubbele oogbescherming.
- Noodstop werkt als een stopknop, m.a.w. de noodstop remt niet brusk, maar loopt uit. Reden: een slijpsteen mag niet brusk remmen anders springt deze in stukken en kan een gevaar opleveren.
- Vergrendelbare hoofdschakelaar en noodstop dicht bij de werkzone van de gebruiker.
- Door middel van de slijpmolen uit te rusten met een afzuigadapter 713107105 voor SM200NS en 713107106 voor de SM250NS, kan een afzuiginstallatie worden gemonteerd.
- Inclusief sokkel.

Order nr.		790025000 ^M	790025002 ^M	790025004 ^M
Orig. nr.		SM200NS 230V	SM200NS 400V	SM250NS 400V
Spanning	V	230	3x400	3x400
Slijpsteenafmetingen (diameter x b x asgat)	mm	200x30x32	200x30x32	250x40x32
Toerental	min-1	2850	2850	2850
Vermogen motor	kW	0.60	0.60	1.5
Gewicht	kg	22,00	22,00	45,00
Prijs	€	402,00	429,00	509,00

OPTI



Werkbankslijper met slijpsteen en slijpband.

- Slijpband met achteraanslag, en op grafietband.
- Onderhoudsvrije motor voor continue gebruik.
- Behuizing in gietaluminium.
- Geluidsarme loop.
- Stabiele, verstelbare werkstukaanslag.
- Vervaardigd volgens CE-normen.

Optionele machinevoet (713107100 en 713107101) en wandhouder (713107050) leverbaar.

U wil uw SM slijpmolen ombouwen tot dergelijke versie, dan kunt u een afzonderlijke slijpbandopzet kopen voor de SM200 713107010 en de SM250 713107011.

Order nr.		713101210 ^M	713101213 ^M	713101260 ^M
Orig. nr.		SM200SL230V	SM200SL400V	SM250SL
Spanning	V	230	3x400	3x400
Slijpsteenafmetingen (diameter x b x asgat)	mm	200x30x32	200x30x32	250x40x32
Toerental	min-1	2850	2850	2850
Schuurbandsnelheid	m/s	16,4	16,4	16,4
Afmetingen slijpband	mm	75x762	75x762	75x1016
Diameter afzuiging slijpband	mm	32	32	32
Hoekverstelling	°	90	90	90
Vermogen motor	kW	0,6	0,6	1,5
Gewicht	kg	18,50	18,50	34,00
Afmetingen (l x b x h)	mm	540 x 480 x 270	540 x 480 x 270	670 x 590 x 370
Prijs	€	239,00	259,00	349,00



OPTIC



Robuuste poliermachine voor het polieren van allerlei metalen.

- Zware uitvoering met onderhoudsvrije motor.
- Gegoten aluminium behuizing.
- Krachtige motor met geluidsarme loop.
- Op trillingsdempende gummivoeten.
- Machine volgens CE-norm vervaardigd.

Standaard geleverd met zachte en harde polierschijf.

Optionele machinevoet (713107100 en 713107101) en wandhouder (713107050) leverbaar.

Order nr.		713101320	713101323	713101325
Orig. nr.		PSM200-230V	PSM200-400V	PSM250
Spanning	V	230	3x400	3x400
Toerental	min-1	2850	2850	2850
Polierschijfafmetingen (diameter x b x asgat)	mm	200x20x16	200x20x16	250x25x20
Vermogen motor	kW	0,6	0,6	1,5
Gewicht	kg	14,00	14,00	24,00
Afmetingen (l x b x h)	mm	550 x 200 x 260	550 x 200 x 260	630 x 250 x 320
Prijs	€	239,00	249,00	298,00



Manuele vlaklijpmachine. Metalworks. Uw eigen betaalbare vlaklijpmachine voor het slijpen van elektroden, ponsen en matrijzen, messen, snijgereedschap, ringen, juwelen, ...

- Zware, massieve gietijzeren uitvoering (240 kg), maar nog steeds compact
- Eenvoudige bediening door middel van de handwielen.
- Voedingen in Y en Z worden manueel gegeven door een rotatie van het handwiel. (Y hoogte, Z dwars)
- Met aparte start en stopknop, alsook een afzonderlijke noodstop.
- Centrale smering van de geleidingen van de tafel.
- Opspanning van het werkstuk gebeurt door middel van de meegeleverde permanente magneetplaat.
- Voorzien van een afscherming op de werktafel.
- Groot gedimensioneerde kruistafel met T-gleuf.

Standaard geleverd met:

- 1 standaard slijpsteen 180x31,75x13 mm
- 1 permanente magneetplaat
- Nederlandstalige handleiding, opschriften, CE - kenmerk, en CE attest volgens Machine Richtlijn 2006/42/CE.

Sokkel niet inbegrepen.

Order nr.		790024050 
Orig. nr.		VSM340X170
Spanning	V	230
Slijpsteenafmetingen (diameter x b x asgat)	mm	180x31,75x13
Vermogen motor	kW	0,55
T-gleuven	mm	12
Elektrische voeding		230V - 50Hz
Afmetingen tafel	mm	152x304
Voeding Y-as	mm	0,02
Voeding Z-as	mm	0,025
Langsverplaatsing	mm	340
Dwarsverplaatsing	mm	170
Maximale slijplengte	mm	470
Maximale slijpbreedte	mm	165
Maximum lading (plaat inbegrepen)	kg	9
Hoogte onder slijpsteen	mm	210
Gewicht	kg	260,00
Afmetingen (l x b x h)	mm	930 x 780 x 730
Prijs	€	2.690,00

OPTIMUM



Wandhouder met opvangbakje voor slijpmachines QSM, SM en PSM. Tot Ø 250mm.

Order nr.	713107050	
Orig. nr.	MH01	
Gewicht	kg	0,10
Afmetingen (l x b x h)	mm	320 x 320 x 250
Prijs	€	52,00

OPTIMUM



Machinevoet voor slijpmachines QSM, SM en PSM. Tot Ø 250mm.

Order nr.	713107100	
Orig. nr.	FS10	
Gewicht	kg	5,00
Afmetingen (l x b x h)	mm	850 x 350 x 315
Prijs	€	79,00

OPTIMUM



Machinevoet voor SM150 tot SM300 met afsluitbare opbergkast en opvangbakje voor koelvloeistof

Order nr.	713107103	
Orig. nr.	FS15	
Gewicht	kg	75,00
Afmetingen (l x b x h)	mm	750 x 380 x 420
Prijs	€	239,00

OPTIMUM



Universele machinevoet SSM met afsluitbare opbergkast en opvangbakje voor koelvloeistof. Voor slijpmachines QSM, SM en PSM. Tot Ø 250mm.

Order nr.	713107101	
Orig. nr.	FS13	
Gewicht	kg	35,00
Afmetingen (l x b x h)	mm	830 x 360 x 310
Prijs	€	285,00

METALWORKS



Sokkel voor vlaklijpmachine VSM340x170.

Order nr.	790024053	
Orig. nr.	SVSM340	
Gewicht	kg	54,00
Afmetingen (l x b x h)	mm	720 x 550 x 550
Prijs	€	245,00

Werkbankslijpstenen voor slijpmolens Optimum model SM en andere slijpmolens indien rekening gehouden wordt met het asgat en breedte van de slijpsteen. Beschikbaar in twee korrelsoorten. Grove korrelsoort 36 voor het brutere werk en een fijnere korrelsoort 80 voor het fijnere werk. Slijpstenen zijn geschikt voor het slijpen van HSS.



Order nr.	Orig. nr.	Slijpsteenafmetingen (diameter x b x asgat) mm	Korrel K	Voor type	Prijs €
713107150	3107150	150x20x16	36	QSM150	11,50
713107155	3107155	150x20x16	80	QSM150	11,50
713107170	3107170	175x20x32	36	QSM175	15,50
713107175	3107175	175x20x32	80	QSM175	15,50
713107180	3107180	175x25x32	36	SM175	16,50
713107185	3107185	175x25x32	80	SM175	16,50
713107200	3107200	200x25x32	36	QSM200	19,50
713107205	3107205	200x25x32	80	QSM200	19,50
713107210	3107210	200x30x32	36	SM200	19,50
713107215	3107215	200x30x32	80	SM200	19,50
713107250	3107250	250x30x32	36	SM250	30,50
713107255	3107255	250x30x32	80	SM250	30,50
713107270	3107270	300x50x75	36	SM300	57,00
713107275	3107275	300x50x75	80	SM300	57,00



Polierschijven voor Optimum poliermachines PSM.

Order nr.	Orig. nr.	Omschrijving	Diameter mm	Voor type	Asgat mm	Prijs €
713107320	3107320	zacht	200x20	PSM 200	16	22,50
713107321	3107321	hard	200x20	PSM 200	16	22,50
713107330	3107330	zacht	250x25	PSM 250	20	28,50
713107331	3107331	hard	250x25	PSM 250	20	28,50

Metallkraft



AS1400



AS1600

AS1400- Stofafzuiging voor metaal- en houtstof. Instapmodel met uitneembare stofzak. Startklaar geleverd met afzuigslangen \varnothing 75mm van 1 en 2 meter. Geschikt voor gebruik met o.a. Metallkraft MBSM en BTS bandschuurmachines of met alle slijpmolens.

AS1600 - Stofafzuiging voor metaal- en houtstof. Profi model met grote en snel verwisselbare filter. Groot afzuigdebiet. Startklaar geleverd met stofzak, afzuigslangen \varnothing 75mm van 1 en 2 meter. Geschikt voor gebruik met o.a. Metallkraft MBSM en Metalworks BS bandschuurmachines.

Order nr.		713922011	713922000
Orig. nr.		AS1400	AS1600
Vermogen motor	kW	0,37	0,75
Diameter aansluiting	mm	2x75	2x100
Debiet	m ³ /u	840	1800
Gewicht	kg	58,00	31,00
Prijs	€	555,00	855,00

Accessoires voor AS1400 en AS1600.

Order nr.	Orig. nr.	Omschrijving	Voor type	Diameter mm	Lengte m	Prijs €
713922002	3922002	stofzak	AS1600			40,50
713922003	3922003	afzuigslang	AS1600	100		28,90
713922004	3922004	afzuigslang	AS1600	100	2	57,50
713922012	3922012	slang	AS1400	75	1	24,90
713922013	3922013	slang	AS1400	75	2	49,50
713922014	3922014	vervangfilter	AS1400			30,90

Ruime keuze andere modellen vindt u terug op onze website:



713700051
Band- & schijfschuurmachine



713922075
Bandschuurmachine



713705100
Combinatieslijpmachine



713730251
Borstel ontbraammachine



713990016
Ontbraamtoestel



713701500
Breedband schuurmachine



metallkraft[®]

Metallbearbeitungsmaschinen

METALLKRAFT METALWORKING MACHINERY FOR CRAFTSMEN AND INDUSTRIAL CUSTOMERS

The majority of METALLKRAFT machines are produced in the European Community by carefully selected manufacturers which have a long time experience.

Thanks to the thorough selection of manufacturers the high demand for best quality from our customers in industry and craftsmanship is satisfied.

A large part of sheet metal working machines are produced by the "Durmazlar" company in Turkey, which have been producing since more than 50 years now.

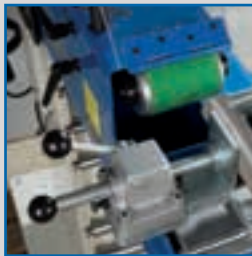



Metalworking machinery

Grinding
Deburring
Cutting
Pressing
Bending
Drilling
Sawing
Accessories



Cirkelzaagmachines

metall-wart



ZAAG-CAPACITEIT		
0°		82mm
45°		56mm



Sneldraaiende cirkelzaagmachine voor de industrie en bouw voor het zagen van aluminium, staal en roestvrij staalprofielen.

- Sneldraaiende cirkelzaagmachine 2.600 min-1
- Ideale machine in montage- en onderhoudsbedrijven, standenbouw, werkplaatsen of voorbereiding op laswerkzaamheden, sanitair.
- Ideaal inzetbaar, daar waar de doorslijpschijf niet sterk genoeg is of onzuiver werk levert.
- Stabiele en robuuste bouw en toch een lichtgewicht met 7,1 kg.
- Zaaft in staal, aluminium en roestvast staal zonder bramen of kromtrekking.
- Hoog belastbare motor met hoge aanlopen thermiek en overbelastingsbeveiliging.
- Voorzien van twee handgrepen op twee verscheidene plaatsen, zodat de zaagmachine steeds goed in de hand ligt bij het bedienen.
- Met geleidingsprofiel voor het oriënteren van het uit de vrije hand zagen.
- Vlugge zaagbladwissel door borgpen
- Geringe hitte- en vonkenontwikkeling.
- Eenvoudige en precieze zaaginstelling.
- Geschikt voor plaatwerk en profielen.
- Geleverd zonder zaagblad, met kunststof koffer.

MACHINES

Order nr.		713840231
Orig. nr.		HKS230
Spanning	V	1x230
Diameter zaagblad x asgat x dikte	mm	230x25,4x2
Vermogen motor	kW	1,7
Zaagsnelheid	min-1	2600
Zaagcapaciteit 90°	mm	82
Zaagcapaciteit 45°	mm	56
Gewicht	kg	9,00
Afmetingen (l x b x h)	mm	520 x 320 x 270
Prijs	€	359,00



ZAAGCAPACITEIT		
	0°	+/-45°
	Ø 132mm	Ø 105mm
	100x180mm	120x90mm
	120mm	90mm

ZAAGBLADEN
p.1092



Droog zagende cirkelzaagmachine, voor het zagen van metaalprofielen zonder koeling.

- Uiterst stabiele en robuuste constructie
- Licht transporteerbaar
- voor het braamloos en vonkenvrij zagen van profielen en buizen uit staal, ijzer, koper, messing, aluminium, legeringen en roestvrij staal zonder koelmiddel.
- Ideale machine in montage- en onderhoudsbedrijven, standenbouw, werkplaatsen of voorbereiding op laswerkzaamheden, sanitair.
- Motor met soft start voor het eenvoudig starten van de zaagmachine.
- Standaard uitgerust met een prismabek om het materiaal beter te klemmen.
- Spanschroef met snelklemming
- 5 maal langere standtijd door het plaatsen van het materiaal onder 45° in een prisma spanschroef, daarvoor zijn bijkomende prismabekken optioneel te verkrijgen.
- Met diepteaanslag voor precieze zaagsnedes
- Met uitneembare spanenopvangbak
- Hoek- en parallelaanslag voor versteksnede tot 45°.
- Met spindelblokkering voor snelle zaagbladwissel.

Standaard geleverd met:

- 1 prismaspanbek,
- 3 zeskant sleutels (4 / 6 / 8 mm),
- beschermglas.
- Zonder zaagblad.

Order nr.	713849314	
Orig. nr.		MTS356
Spanning	V	1x230
Vermogen motor	kW	2,2
Zaagsnelheid	min-1	1300
Diameter zaagblad x asgat	mm	355 X 25,4
Opening klem	mm	180
Gewicht	kg	24,00
Afmetingen (l x b x h)	mm	680 x 360 x 580
Prijs	€	559,00

Zaagmachines

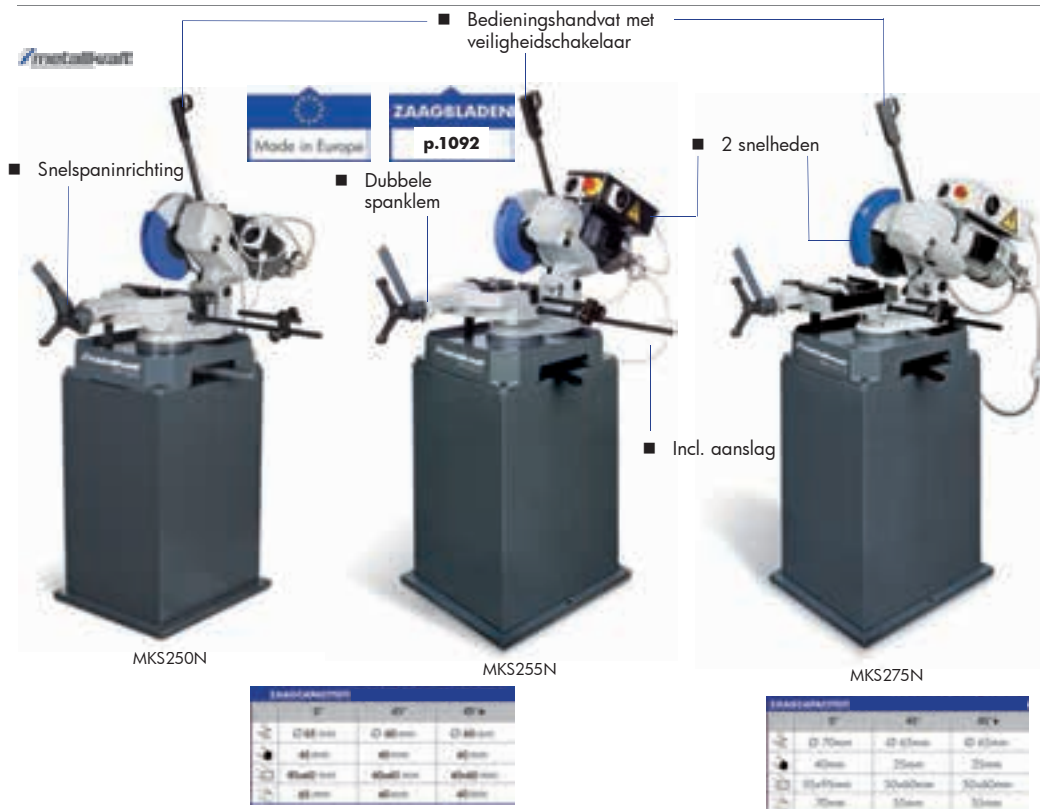

Manuele cirkelzaagmachine met één (MKS250N) of twee (MKS255N) zaagsnelheden en onder hoek verstelbare zaagkop en aansproef. "Made in EU".

- Traag draaiend type met koeling. 230V motor met 1 snelheid (MKS250N) of 400V motor met 2 snelheden (MKS255N).
- Voor het zagen van metalen profielen, zowel buis als vol materiaal staal, ijzer, lichte materialen.
- Tandwieloverbrenging via worm en wormwiel, lopend in een oliebad.
- Voorzien van messing tandwiel tegen breuk bij overbelasting
- Automatische membraankoelpomp met koelmiddelfilter
- Kantelbare zaagbladafscherming voor optimale veiligheid bij het zagen
- Bedieningshandvat met veiligheidsschakelaar
- Elektrische 24V laagspanningsbediening, noodstop, hoofdschakelaar en overbelastingsthermie.
- Draaibare zaagkop en spanklem 45° links naar 45° rechts.
- Dubbele spanklem met snelspan inrichting en antibraam houder.

Standaard met :

- Koelpomp met filter, - Lengteaanslag 500mm., - Zonder zaagblad MKS250N / MKS255N 713652504 of 713652506, - Zonder zaagblad MKS275N 713652754 of 713652756 of 713652758, - Zonder sokkel 713642571.

Order nr.		713620251 M	713620253 M	713620275 M
Orig. nr.		MKS250N	MKS255N	MKS275N
Spanning	V	1x230	3x400	3x400
Vermogen motor	kW	0,9	0,95-1,32	1,1-1,5
Zaagsnelheid	min-1	40	40/80	40/80
Diameter zaagblad x asgat	mm	250 x 32	250 x 32	275x32
Opening klem	mm	100	100	105
Gewicht	kg	83,00	83,00	98,00
Afmetingen (l x b x h)	mm	800 x 830 x 750	800 x 830 x 750	830 x 900 x 1025
Prijs	€	1.295,00	1.290,00	1.590,00

Universele machinevoet.

Order nr.		713642571 M
Orig. nr.		UM25
Voor type		MKS250-MKS255N-MKS251
Gewicht	kg	19,50
Prijs	€	219,00



ZAAGCAPACITEIT	0°	±45°
	Ø 90mm	Ø 80mm
	55mm	50mm
	115x70mm	70x70mm
	80mm	70mm

Manuele cirkelzaagmachine met zaagblad ø 315 mm, twee snelheden en onder hoek verstelbare zaagkop en spanschroef. "Made in EU".

- Traag draaiend type met koeling en 3x400V motor met 2 snelheden.
- Voor het zagen van metalen profielen, zowel buis als vol materiaal staal, ijzer, lichte materialen.
- Tandwieloverbrenging via worm en wormwiel, lopend in een oliebad.
- Voorzien van messing tandwiel tegen breuk bij overbelasting
- Automatische membraan koelpomp met koelmiddelfilter
- Kantelbare zaagbladafscherming voor optimale veiligheid bij het zagen
- Bedieningshandvat met veiligheidsschakelaar
- Elektrische 24V laagspanningsbediening, noodstop, hoofdschakelaar en overbelastingsthermiek.
- Draaibare zaagkop en spanklem 45° links naar 45° rechts.
- Dubbele spanklem met snelspan inrichting en antibraam houder.

Standaard met :

- Koelpomp met filter
- Lengteaanslag 500mm.
- Zonder zaagblad 713653154 of 713653156 of 713653158
- Zonder sokkel 713643171.

Order nr.	713620303	
Orig. nr.	MKS315N	
Spanning	V	3x400
Vermogen motor	kW	1,5-2,2
Zaagsnelheid	min-1	40/80
Diameter zaagblad x asgat	mm	315 x 32
Opening klem	mm	120
Gewicht	kg	150,00
Afmetingen (l x b x h)	mm	1000 x 1150 x 1475
Prijs	€	2.170,00

Universele machinevoet.

Order nr.	713643171	
Orig. nr.	UM35	
Voor type	MKS315-350	
Gewicht	kg	25,00
Prijs	€	219,00



metallkraft



ZAAGCAPACITEIT		
	0°	+/-45°
	Ø 100mm	Ø 80mm
	65mm	60mm
	120x70mm	80x70mm
	85mm	70mm

Manuele cirkelzaagmachine **met slippkoppeling**, zaagblad ø 315 mm, twee snelheden en onder hoek verstelbare zaagkop en spanschroef. "Made in EU".

- Traag draaiend type met koeling en 3x400V motor met 2 snelheden 40/80 tpm.
Er bestaat ook een type met snelheden 20/40 tpm, ordernr. 713621316.
- Voor het zagen van metalen profielen, zowel buis als vol materiaal staal, ijzer, lichte materialen.
- Tandwieloverbrenging via worm en wormwiel, lopend in een oliebad.
- Voorzien van messing tandwiel tegen breuk bij overbelasting
- Automatische membraan koelpomp met koelmiddelfilter
- Kantelbare zaagbladafscherming voor optimale veiligheid bij het zagen
- **Uitgerust met een slippkoppeling, waardoor het breken van het zaagblad wordt uitgesloten**
- Bedieningshandvat met veiligheidsschakelaar
- Elektrische 24V laagspanningsbediening, noodstop, hoofdschakelaar en overbelastingsthermiek.
- Draaibare zaagkop en spanklem 45° links naar 45° rechts.
- Dubbele spanklem met snelspan inrichting en antibraam houder.

Standaard met :

- Koelpomp met filter
- Lengteaanslag 500mm.
- Zonder zaagblad 713653154 of 713653156 of 713653158
- Zonder sokkel 713643171.

Order nr.	713621315 M	
Orig. nr.	MKS315R	
Spanning	V	3x400
Vermogen motor	kW	1,5-2,2
Zaagsnelheid	min-1	40/80
Diameter zaagblad x asgat	mm	315x32
Opening klem	mm	120
Gewicht	kg	170,00
Afmetingen (l x b x h)	mm	1150 x 1000 x 1475
Prijs	€	2.940,00

Universele machinevoet.

Order nr.	713643171 M	
Orig. nr.	UM35	
Voor type	MKS315-350	
Gewicht	kg	25,00
Prijs	€	219,00



metallwerk



ZAAGCAPACITEIT		
	0°	+/-45°
	Ø 100mm	Ø 80mm
	60mm	55mm
	120x80mm	80x80mm
	100mm	80mm

Manuele cirkelzaagmachine met zaagblad ø 350 mm, twee snelheden en onder hoek verstelbare zaagkop en spanskroef. "Made in EU".

- Traag draaiend type met koeling en 3x400V motor met 2 snelheden 40/80 tpm.
- Er bestaat ook een model MKS351 met 2 snelheden 20/40 tpm.
- Stabiele en robuuste constructie
- Voor het zagen van metalen profielen, zowel buis als vol materiaal staal, ijzer, lichte materialen.
- Tandwieloverbrenging via worm en wormwiel, lopend in een oliebad.
- Voorzien van messing tandwiel tegen breuk bij overbelasting
- Automatische membraan koelpomp met koelmiddelfilter
- Kantelbare zaagbladafscherming voor optimale veiligheid bij het zagen
- Bedieningshandvat met veiligheidsschakelaar
- Elektrische 24V laagspanningsbediening, noodstop, hoofdschakelaar en overbelastingsthermie.
- Draaibare zaagkop en spanskroef 45° links naar 45° rechts.
- Dubbele spanskroef met snelspan inrichting en antibraam houder.
- Ook verkrijgbaar in halfautomatische uitvoering 713620352.

Standaard met :

- Koelpomp met filter , - Lengteanslag 500mm. , - Zonder zaagblad 713653506 of 713653504 , - Zonder sokkel 713643171.

Order nr.	713621350 ^M	
Orig. nr.	MKS350	
Spanning	V	3x400
Vermogen motor	kW	1,8-2,4
Zaagsnelheid	min-1	40/80
Diameter zaagblad x asgat	mm	350 x 32
Opening klem	mm	120
Gewicht	kg	210,00
Afmetingen (l x b x h)	mm	1000 x 1200 x 1475
Prijs	€	3.495,00

Universele machinevoet.

Order nr.	713643171 ^M	
Orig. nr.	UM35	
Voor type	MKS315-350	
Gewicht	kg	25,00
Prijs	€	219,00

OPTI

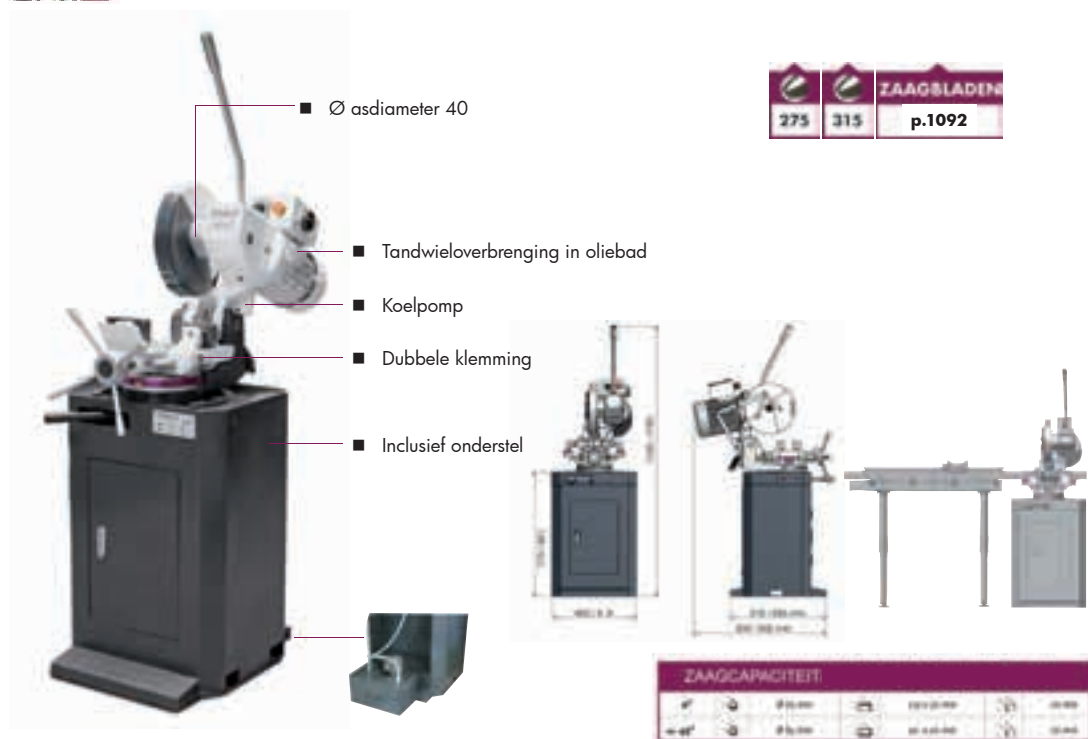

Manuele cirkelzaagmachine voor het zagen van staal, ijzer, lichte materialen en profielen.

- Traag draaiend type met koeling en 3x400V motor met 2 snelheden.
- Stabiele en robuuste constructie, met zware sokkel
- Krachtige en stille motor
- As ø 40
- Centrisch spannende en dubbele spanklem met snelspan inrichting, met 4 geleidingen en 4 afzonderlijk verstelbare spanbekken, voorzien van antibraam inrichting.
- Voor het zagen van metalen profielen, zowel buis als vol materiaal staal, ijzer, lichte materialen.
- Tandwieloverbrenging via worm en wormwiel, lopend in een oliebad.
- Gesloten koelvoelstofinrichting met uitneembare koelmiddelreservoir, voor eenvoudig reinigen, met geïntegreerde krachtige koelpomp
- Kantelbare zaagbladafscherming voor optimale veiligheid bij het zagen
- Duidelijk afleesbare schaalverdeling maken precies werken mogelijk
- Sokkel is voorzien van gaten langs beide zijden voor de aanbouw van de optionele rollenbaan MSR4, MSR7 en MSR10.
- Geïntegreerde aan/uit drukknop in het handvat
- Elektrische 24V laagspanningsbediening, noodstop, hoofdschakelaar en overbelastingsthermie.
- Draaibare zaagkop 45° links naar 45° rechts.

Standaard met :

- Sokkel
- Koelpomp en uitneembare koeltank
- Zonder zaagblad zie accessoires

Order nr.		713302275 ^M	713302300 ^M
Orig. nr.		CS275	CS315
Spanning	V	3x400	3x400
Vermogen motor	kW	2,0-1,40	1,5-0,75
Vermogen koelpomp	W	40	40
Zaagsnelheid	min-1	41/82	19/38
Diameter zaagblad x asgat	mm	275 x 40	315 x 40
Opening klem	mm	110	135
Gewicht	kg	160,00	230,00
Afmetingen (l x b x h)	mm	940 x 560 x 1510	910 x 546 x 1759
Prijs	€	1.689,00	2.049,00

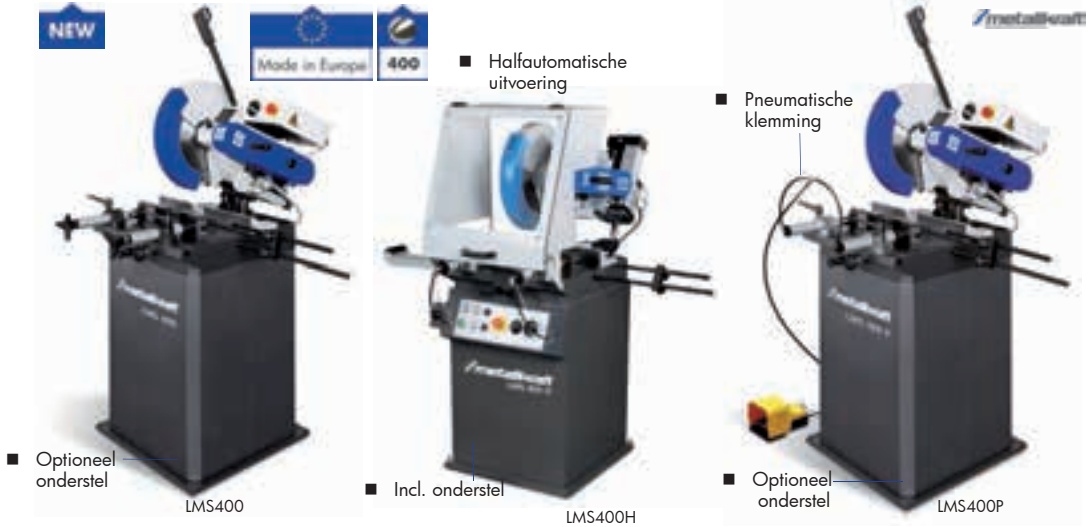

Manuele sneldraaiende afkortzaag met zaagblad \varnothing 400 mm **voor aluminium** en non-ferrometalen. "Made in EU"

- Stabiele en robuuste uitvoering.
- Eenvoudige bediening. Precieze zaagsnede.
- Draaibare machinekop 45° links en 45° rechts.
- Eenvoudig 45° draaien van de zaagkop door positiestops.
- Op rollagers gemonteerde zaagkop en schaal.
- Op rollagers gemonteerde zaagas
- Elektrische bediening 24V met noodstopshakelaar en overbelastingthermiek

LMS400:

- Manuele uitvoering
- 2 manuele spanklemmen met kunststofbelegde Alu klauwen.
- Neigbare zaagkop 45° naar links van de zaagsnede

LMS400H:

- **Halfautomatische uitvoering**
- 2 pneumatische snelspanklemmen
- Met kunststofbelegde Alu spanbekken



Cap. max. mm				
0°	140	80	180x100	110
-45°	130	80	150x100	100
-45°	130	80	150x100	100

LMS400P:

- Neigbare zaagkop 45° naar links van de zaagsnede
- Pneumatische spanklem
- Met kunststofbelegde Alu spanbekken
- Bedieningshandvat met veiligheidsschakelaar

Standaard geleverd met:

- Lengteaanslag 500 mm
- Bedieningsleutels
- LMS400 en LMS400P zonder zaagblad en zonder sokkel,
- LMS400H inclusief materiaaloplegrol en sokkel, zonder zaagblad

Let op: niet geschikt voor volmetalen, staal, of andere harde metaalsoorten. Hiervoor raden wij de Metallkraft MKS-machines aan.

Order nr.	713625400 ^M	713625401 ^M	713625402 ^M
Orig. nr.	LMS400	LMS400H	LMS400P
Spanning	V	3x400	3x400
Vermogen motor	kW	2,2	2,2
Zaagsnelheid	min-1	3000	3000
Diameter zaagblad	mm	400	400
Gewicht	kg	160,00	210,00
Afmetingen (l x b x h)	mm	1500 x 1000 x 900	1500 x 1000 x 1600
Prijs	€	2.950,00	6.090,00
			3.590,00

Machinevoet LMS400 - LMS400P

Order nr.	713644071 ^M
Orig. nr.	UM40
Gewicht	kg
Prijs	€
	229,00

Ruime keuze andere modellen vindt u terug op onze website:



713620352
Halfautomatische afkortzaag



713622350
Manuele verticale afkortzaag



713623350
Halfautomatische verticale afkortzaag



713624350
Automatische verticale afkortzaag



713608012
Microdoseersysteem



713625404
Automatische alu afkortzaag



Lintzaagmachines

NEW **ZAAGBLADEN** **0,55 KW**
p.1094



Licht gewicht manuele bandzaagmachine onder hoek verstelbaar, perfect te gebruiken op de bouwerven.

- Lichte bandzaag machines voor het zagen van metaal en kunststof.
- Ideaal voor inzet op de bouwplaats.
- 3-voudige kogelgelagerde bandzaaggeleiding.
- Drie zaagsnelheden door het verleggen van de aandrijfriem geven een brede keuze in de te zagen materialen.
- Zaagbeugel verstelbaar in verstek van 0° tot 45°.
- Daalvoeding door eigen gewicht over een veer.
- Goed afleesbare verstekschaal.
- Met lengteaanslag bij de klemming.
- Snelspan klemming en automatische eindloop schakelaar en veiligheidsschakelaar in de riemenkast

Standaard geleverd

- handig onderstel
- bi-metaal zaaglint

Order nr.	713300122	
Orig. nr.	S122G	
Vermogen		
Spanning	V	1x230
Vermogen motor	kW	0,55
Afmetingen		
Zaagsnelheid	m/min	21 - 31 - 54
Afmetingen zaaglint (l x h x d)	mm	1638x130x65
Opheffen zaagbeugel		Manueel
Breedte zonder materiaalaanslag	mm	550
Breedte met materiaalaanslag	mm	620
Hoogte onderste eindpositie zaagbeugel	mm	1060
Hoogte bovenste eindpositie zaagbeugel	mm	1430
Gewicht	kg	67,50
Afmetingen (l x b x h)	mm	1100 x 520 x 470
Prijs	€	449,00

■ Licht & mobiel

OPTI



S100G

ZAAGBLADEN 0,37 KW
p.1094



Lichte en handige metaal bandzaagmachine.

- Voor universeel gebruik in elke servicewagen, werkplaats, voor hobby- en landbouwdoeleinden.
- Automatische afslag na het doorzagen.
- Onder verstek instelbare zaagbeugel van 0° tot 45°.
- Gepatenteerde snelspan klemming.
- 3-voudige kogelgelagerde bandzaaggeleiding.
- Zaagbeugel daalt door zijn eigen gewicht. Dalingsdruk van de zaagbeugel in 3 posities instelbaar.
- Zaagbeugel kan vast worden gezet voor transport.

Standaard geleverd

- Bi-metaal lintzaag
- Materiaalaanslag.
- Zonder sokkel.

Order nr.	713300100	
Orig. nr.	S100G	
Vermogen		
Spanning	V	1x230
Vermogen motor	kW	0,37
Afmetingen		
Zaagsnelheid	m/min	45
Afmetingen zaaglint (l x h x d)	mm	1470x13x0,65
Opheffen zaagbeugel		manueel
Lengte met gesloten spanklem	mm	850
Lengte met geopende spanklem	mm	950
Breedte zonder materiaalaanslag	mm	300
Breedte met materiaalaanslag	mm	660
Hoogte onderste eindpositie zaagbeugel	mm	680
Hoogte bovenste eindpositie zaagbeugel	mm	820
Gewicht	kg	23,00
Afmetingen (l x b x h)	mm	720 x 380 x 460
Prijs	€	549,00



Universele stalen sokkel voor S100G en MTS356.

- Stabiel
- Plaats besparend
- Opklapbaar
- Licht transporteerbaar

Order nr.	713351490	
Orig. nr.	3351490	
Gewicht	kg	10,50
Afmetingen (l x b x h)	mm	790 x 508 x 160
Prijs	€	113,00



metallcraft



ZAAGCAPACITEIT			
Hoek	Staal	IJzer	Alu. x PVC
90°	105	105	104 x 105
45°	70	70	70 x 70
45°	-	-	-



Lichte, handige en professionele bandzaagmachines **met variabele zaagsnelheid**. "Made in EU".

- Bijzonder geruisloze vario-motor.
- Toerental variabel regelbaar van 30 tot 80m/min.
- Dankzij de speciaal ontworpen motor met een dito aandrijving naar het zaagwiel trillingsarm en 60% geruislozer dan gelijkaardige zaagmachines.
- Geschikt voor het zagen van staal, ijzer, aluminium, koper, pvc, teflon,...
- Zaagspanning regelbaar d.m.v. instelknop aan de voorkant van de zaagbeugel.
- Goed afleesbare schaal voor de aanduiding van de hoekinstelling van de zaagbeugel op 1° nauwkeurig.
- Geschikt voor zowel droog- als natzagen.
- Kogellagers met extreem sterke gietijzeren loopwielen
- Langere levensduur van de zaagbeugel door afzonderlijke zaagbandgeleidingen

Standaard geleverd met:

- Materiaalklem
- Materiaalaanslag
- bi-metaal zaagblad

Order nr.		713630105
Orig. nr.		MBS105
Vermogen		
Spanning	V	1x230
Vermogen motor	kW	0,85
Afmetingen		
Zaagsnelheid	m/min	30-80 Vario
Afmetingen zaaglint (l x h x d)	mm	1335x13x0,65
Afmetingen voet (b x d)	mm	720x320
Gewicht	kg	18,00
Afmetingen (l x b x h)	mm	720 x 320 x 450
Prijs	€	459,00

metall-wafl



Lichte, handige en professionele bandzaagmachines **met variabele zaagsnelheid**. "Made in EU".

- Bijzonder geruisloze vario-motor.
- Toerental variabel regelbaar van 30 tot 80m/min.
- Dankzij de speciaal ontworpen motor met een dito aandrijving naar het zaagwiel trillingsarm en 60% geruislozer dan gelijkaardige zaagmachines.
- Geschikt voor het zagen van staal, ijzer, aluminium, koper, pvc, teflon,...
- Zaagspanning regelbaar d.m.v. instelknop aan de voorkant van de zaagbeugel.
- Goed afleesbare schaal voor de aanduiding van de hoekinstelling van de zaagbeugel op 1° nauwkeurig.
- Geschikt voor zowel droog- als natzagen.
- Kogellagers met extreem sterke gietijzeren loopwielen
- Langere levensduur van de zaagbeugel door afzonderlijke zaagbandgeleidingen

Standaard geleverd met:

- Materiaalklem
- Materiaalaanslag
- bi-metaal zaagblad.

Order nr.		713630125
Orig. nr.		MBS125
Vermogen		
Spanning	V	1x230
Vermogen motor	kW	1,2
Afmetingen		
Zaagsnelheid	m/min	30-80 Vario
Afmetingen zaaglint (l x h x d)	mm	1440x13x0,65
Afmetingen voet (b x d)	mm	720x320
Gewicht	kg	19,00
Afmetingen (l x b x h)	mm	720 x 320 x 470
Prijs	€	625,00



metalfant



ZAAGCAPACITEIT			
90°	150	110	90 x 110
45° L	100	90	100 x 90
60° R	70	65	65 x 70



Lichte, handige en professionele bandzaagmachines **met variabele zaagsnelheid**. "Made in EU".

- Bijzonder geruisloze vario-motor.
- Toerental variabel regelbaar van 30 tot 80m/min.
- Dankzij de speciaal ontworpen motor met een dito aandrijving naar het zaagwiel trillingsarm en 60% geruislozer dan gelijkaardige zaagmachines.
- Geschikt voor het zagen van staal, ijzer, aluminium, koper, pvc, teflon,...
- Zaagspanning regelbaar d.m.v. instelknop aan de voorkant van de zaagbeugel.
- Goed afleesbare schaal voor de aanduiding van de hoekinstelling van de zaagbeugel op 1° nauwkeurig.
- Geschikt voor zowel droog- als natzagen.
- Kogellagers met extreem sterke gietijzeren loopwielen
- Langere levensduur van de zaagbeugel door afzonderlijke zaagbandgeleidingen

Standaard geleverd met:

- Materiaalklem
- Materiaalaanslag
- bi-metaal zaagblad.

Order nr.		713630150
Orig. nr.		MBS150
Vermogen		
Spanning	V	1x230
Vermogen motor	kW	1,5
Afmetingen		
Zaagsnelheid	m/min	30-80 Vario
Afmetingen zaaglint (l x h x d)	mm	1735x13x0,65
Afmetingen voet (b x d)	mm	1000x390
Gewicht	kg	30,00
Afmetingen (l x b x h)	mm	1000 x 390 x 590
Prijs	€	1.025,00



Lichte, handige en professionele bandzaagmachines **met variabele zaagsnelheid**. "Made in EU".

- Bijzonder geruisloze vario-motor.
- Toerental variabel regelbaar van 30 tot 80m/min.
- Dankzij de speciaal ontworpen motor met een dito aandrijving naar het zaagwiel trillingsarm en 60% geruislozer dan gelijkaardige zaagmachine.
- Geschikt voor het zagen van staal, ijzer, aluminium, koper, pvc, teflon,...
- Zaagspanning regelbaar d.m.v. instelknop aan de voorkant van de zaagbeugel.
- Goed afleesbare schaal voor de aanduiding van de hoekinstelling van de zaagbeugel op 1° nauwkeurig.
- Geschikt voor zowel droog- als natzagen.
- Kogellagers met extreem sterke gietijzeren loopwielen
- Langere levensduur van de zaagbeugel door afzonderlijke zaagbandgeleidingen

Order nr.	713630152
Orig. nr.	MBS155K
Vermogen	
Spanning	V
Vermogen motor	kW
Afmetingen	
Zaagsnelheid	m/min
Afmetingen zaaglint (l x h x d)	mm
Afmetingen voet (b x d)	mm
Gewicht	kg
Prijs	€ 1.169,00

MBS155K



ZAAGBLADEN
p.1094



ZAAGCAPACITEIT			
	□	□	□
90°	150	140	150 x 140
45° ll.	300	90	100 x 90
60° ll.	70	65	65 x 70

Standaard geleverd met :

- Materiaalklem
- Materiaalaanslag
- bi-metaal zaagblad.
- koelinrichting en sokkel.



ZAAGBLADEN 0,55 KW
p.1094

OPTIMUM



snaarbehuizing



zaagbeugel

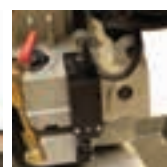

automatische afslag



■ Hydraulische daalcilinder



	Cap.max./mm	
0°	128	100x150
-45°	94	94x78
-60°	56	56x56

■ Incl. mobiele sokkel

Mobiele bandzaagmachine voor het zagen van metaal en kunststof.

- Ideaal voor de lichte zaagwerkzaamheden.
 - Precisie afwerking volgens Optimum normen.
 - Gecontroleerd dalen van de zaagbeugel dankzij een traploos instelbare hydraulische cilinder.
 - Krachtige en stille 550 Watt motor
 - Automatische afslag na het doorzagen
 - Tweezijdig onder verstek instelbare zaagbeugel **van -45° tot +60°**.
 - Bodemplaat, zwenkarm en zaagbeugel van degelijk gietstaal.
 - Snelspanklemming.
 - 3-voudige kogelgelagerde bandzaaggeleiding.
 - Drie zaagsnelheden door het verleggen van de aandrijfriem geven een brede keuze in de te zagen materialen.
 - Verplaatsbare zaagbladgeleiding door middel van handwiel
 - Duidelijk afleesbare schaalverdeling
 - Uitgerust met een aparte noodstop, aparte start en stopknop
 - 24V zeer lage veiligheidspanning
 - Snaarbehuizing alsook de zaagbeugel zijn voorzien van een veiligheidsschakelaar
- Standaard geleverd met:

- Vrijdijbare sokkel
- bi-metaal zaagblad 10-14 tpi
- materiaal aanslag.
- Nederlandstalige handleiding, opschriften, CE - kenmerk, en CE-attest volgens Machine richtlijn 2006/42/CE, Laagspanningsrichtlijn 2006/95/CE en EMC Richtlijn 2004/108/CE

Order nr.	713300131	
Orig. nr.	S131GH	
Vermogen		
Spanning	V	1x230
Vermogen motor	kW	0,55
Afmetingen		
Zaagsnelheid	m/min	22-31-55
Afmetingen zaaglint (l x h x d)	mm	1638x13x0,65
Gewicht	kg	78,00
Afmetingen (l x b x h)	mm	1050 x 450 x 550
Prijs	€	669,00



aparte startknop, aparte stopknop, aparte noodstop, schakelaar koelpomp, potentiometer
Vario drive 20-62 m/min

ZAAOAFMETINGEN			
	0°	45°	60°
	Ø 150 mm	Ø 125 mm	Ø 70 mm
	175 x 280 mm	175 x 175	20 x 90 mm
	150 mm	125 mm	70 mm



Eenvoudige en stevige bandzaagmachine met onder verstek instelbare zaagbeugel 0° tot 60°.

- Stabiele gietijzeren uitvoering.
- Aanhoudend **regelbare zaagsnelheden van 22 tot 65 m/min.**
- Druknop in de hendel voor het activeren en stoppen van de zaag.
- Voet, draaiarm en zaagbeugel is vervaardigd uit grijs gietijzer.
- Kogelgelagerde zaagbladgeleiding.
- Directe, instelbare koeling op het zaagblad.
- Met **ingebouwde koelpomp** in de voet.
- Krachtige en stille motor 1.1 kW
- Snelspan klemming.
- Gebruikersvriendelijke veiligheidsschakelaar met laagspanningsbeveiliging en motorbeveiliging.
- Ergonomisch en gebruiksvriendelijk bedieningspaneel met aparte noodstop, schakelaar voor de koelpomp en potentiometer voor de variabele toerental.

Standaard geleverd met

- Sokkel,
- Koelpomp
- Bi-metalen zaagblad
- materiaal aanslag.
- Nederlandstalige handleiding, opschriften, CE - kenmerk, en CE-attest volgens Machine richtlijn 2006/42/CE, Laagspanningsrichtlijn 2006/95/CE en EMC Richtlijn 2004/108/CE

Order nr.		713300150 M
Orig. nr.		S150G VARIO
Vermogen		
Spanning	V	1x230
Vermogen motor	kW	1,1
Vermogen motor koelpomp	W	50
Afmetingen		
Zaagsnelheid	m/min	20-65
Afmetingen zaaglint (l x h x d)	mm	1735x130x0,90
Opheffen zaagbeugel		Manueel
Lengte met gesloten spanklem	mm	930
Lengte met geopende spanklem	mm	1.120
Breedte zonder materiaal aanslag	mm	510
Breedte met materiaal aanslag	mm	720
Hoogte onderste eindpositie zaagbeugel	mm	1.240
Hoogte bovenste eindpositie zaagbeugel	mm	1.590
Gewicht	kg	100,00
Afmetingen (l x b x h)	mm	1130 x 570 x 840
Prijs	€	1.099,00



Mobiele, robuuste bandzaagmachine voor de metaalbewerking met traploos regelbare zaagdruk.

- Grote zaagcapaciteit door zaagbeugel en groot gedimensioneerde loopwielen
- Zaagvoeding door traploos regelbare **hydraulische cilinder**
- Zagen onder verstek mogelijk dank zij het in het verstek plaatsen van de klem van 0° tot 45°.
- Stabiele gietijzere uitvoering.
- Automatische afslag na het einde van de zaagcyclus.
- Krachtige terughaalveer
- Krachtige en stille motor 0.75 kW
- Zowel in 1x230V als in 3x400V verkrijgbaar
- Met handvat en wielen om eenvoudig te transporteren
- Zaagborstel voor het reinigen van het zaagblad
- Zaagbandgeleiding:
 - 3-punts kogelgelagerde geleiding
 - Uitstekende bandloop met optimale zaagsnede
 - Borstel voor het reinigen van de spanen
- **4 zaagsnelheden** 21 / 33.5 / 45 / 50 m/min door het verleggen van riemen
- Snelspan machineklem
- **Koelmiddelrichting**
 - In onderstel geïntegreerd
 - Inhoud 11 liter
 - Directe, instelbare koeling op het zaagblad.

Order nr.		713300185 ^M	713300181 ^M
Orig. nr.		S181-230V	S181-400V
Vermogen			
Spanning	V	1x230	3x400
Vermogen motor	kW	0,75	0,75
Vermogen motor koelpomp	W	50	50
Afmetingen			
Zaagsnelheid	m/min	21/33,5/45/50	21/33,5/45/50
Afmetingen zaaglint (l x h x d)	mm	2362x19x0,90	2362x19x0,90
Opheffen zaagbeugel		Manueel	Manueel
Lengte met geopende spanklem	mm	1.295	1.295
Breedte zonder materiaal aanslag	mm	450	450
Breedte met materiaal aanslag	mm	600	600
Hoogte onderste eindpositie zaagbeugel	mm	1.060	1.060
Hoogte bovenste eindpositie zaagbeugel	mm	1.550	1.550
Gewicht	kg	130,00	130,00
Afmetingen (l x b x h)	mm		1300 x 460 x 1080
Prijs	€	1.190,00	1.190,00

ZAAGBLADEN 0,75 KW
p.1094

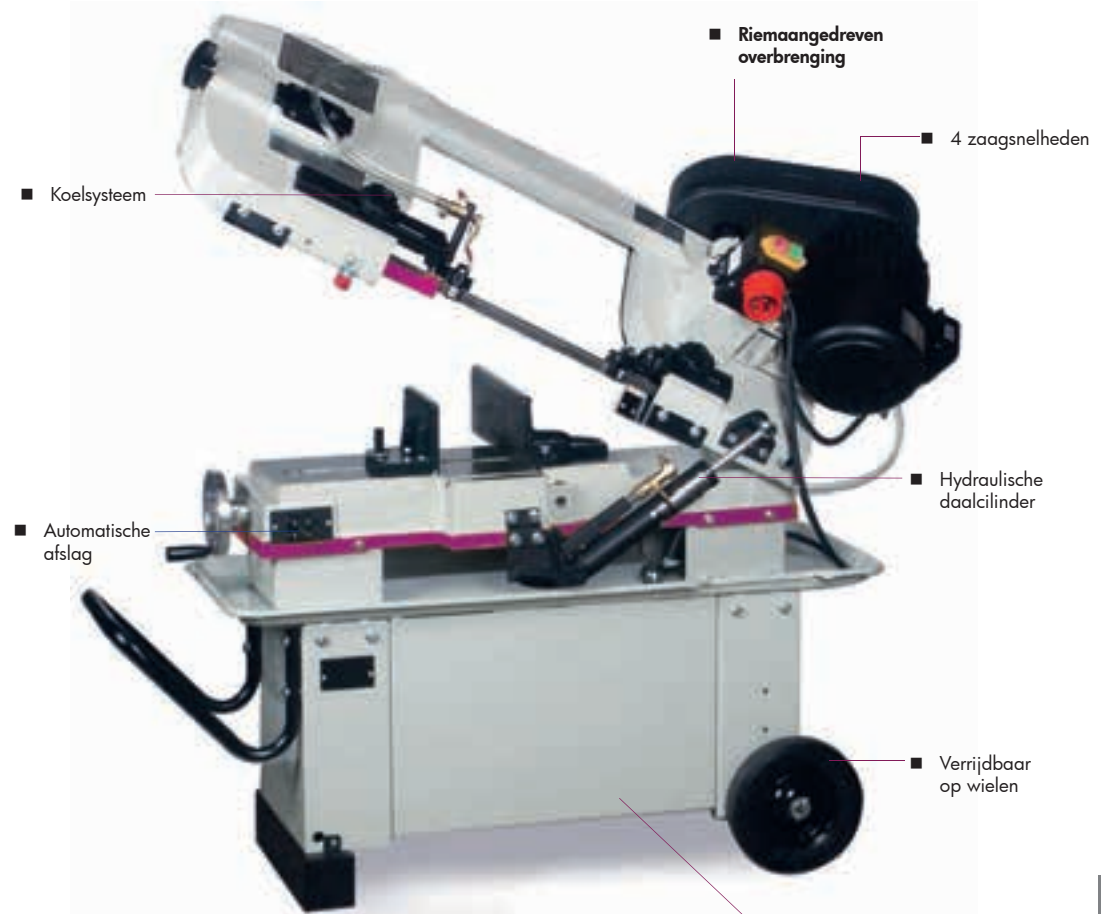

ZAAGCAPACITEIT			
0°		Ø 178 mm	120 x 340 mm
45°		Ø 110 mm	50 x 300 mm
		Ø 110 mm	120 x 340 mm



Zaagbandgeleiding



Snelspan machineklem



Koelmaatsienrichting



Standaard geleverd met :

- Mobiele sokkel,
- Koelpomp
- Bi-metalen zaagblad
- materiaalafslag.
- Nederlandstalige handleiding, opschriften, CE - kenmerk, en CE-attest volgens Machine richtlijn 2006/42/CE, laagspanningsrichtlijn 2006/95/CE en EMC Richtlijn 2004/108/CE



Mobiele, robuuste bandzaagmachine met tandwieloverbrenging met traploos regelbare zaagdruk.

- **Tandwieloverbrenging** met 3 instelbare zaagsnelheden 39 / 66 / 82 m/min
- Grote zaagcapaciteit door zaagbeugel en groot gedimensioneerde loopwielen
- Zaagvoeding door traploos regelbare hydraulische cilinder
- Zagen onder verstek mogelijk dank zij het in het verstek plaatsen van de klem van 0° tot 45°.
- Stabiele gietijzeren uitvoering.
- Precisie afwerking volgens Optimum normen.
- Automatische afslag na het einde van de zaagcyclus.
- Krachtige terughaalveer
- Met ingebouwde koelpomp in de voet.
- Krachtige en stille motor 0.75 kW
- Zowel in 1x230V als 3x400V leverbaar
- Met handvat en wielen om eenvoudig te transporteren
- Zaagborstel voor het reinigen van het zaagblad
- Zaagbandgeleiding:
 - 5-punts kogelgelagerde geleiding
 - Uitstekende bandloop met optimale zaagsnede
 - Borstel voor het reinigen van de spanen
- Snelspan machineklem
- Koelmiddelinrichting
 - In onderstel geïntegreerd
 - Inhoud 11 liter
 - Directe, instelbare koeling op het zaagblad.

Order nr.		713300186 ^M	713300182 ^M
Orig. nr.		S181G-230V	S181G-400V
Vermogen			
Spanning	V	1x230	3x400
Vermogen motor	kW	0,75	0,75
Vermogen motor koelpomp	W	50	50
Afmetingen			
Zaagsnelheid	m/min	39/66/82	39/66/82
Afmetingen zaaglint (l x h x d)	mm	2362x19x0,90	2362x19x0,90
Opheffen zaagbeugel		Manueel	Manueel
Lengte met geopende spanklem	mm	1.200	1.200
Breedte zonder materiaal aanslag	mm	450	450
Breedte met materiaal aanslag	mm	720	720
Hoogte onderste eindpositie zaagbeugel	mm	1.050	1.050
Hoogte bovenste eindpositie zaagbeugel	mm	1.600	1.600
Gewicht	kg	130,00	130,00
Afmetingen (l x b x h)	mm		1300 x 460 x 1118
Prijs	€	1.250,00	1.290,00

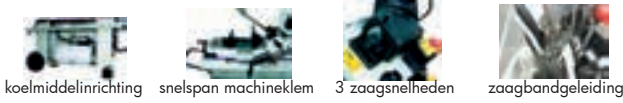

koelmiddelrichting

snelspan machineklem

3 zaagsnelheden

zaagbandgeleiding

ZAAGBLADEN 0,75 KW
p.1094

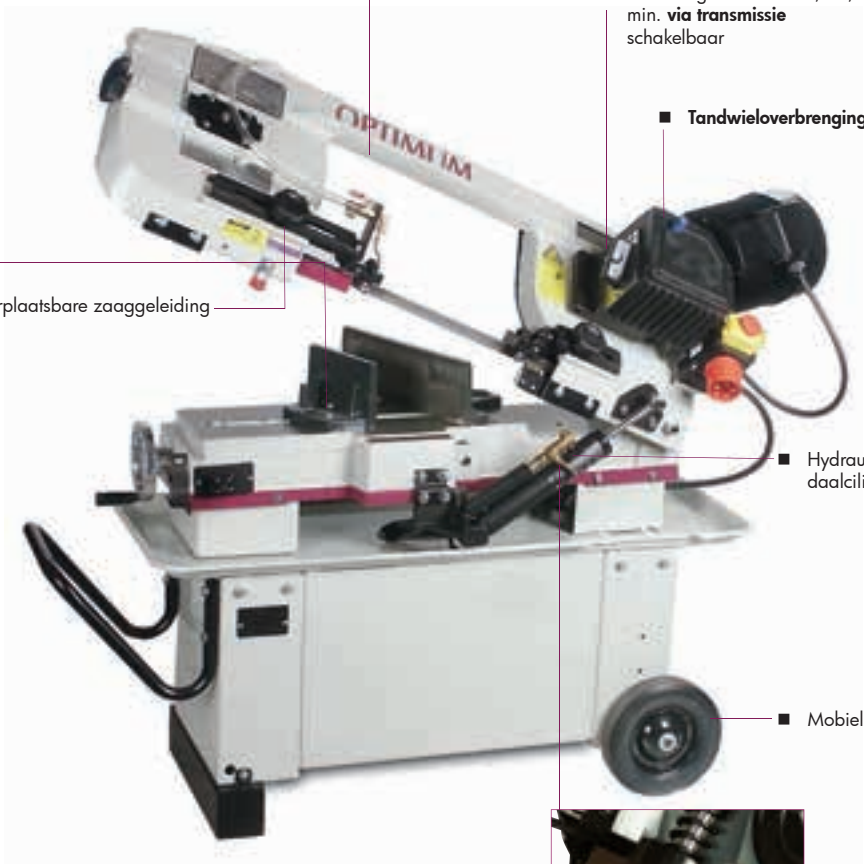

■ Directe koeling op het zaagblad

■ Drie zaagsnelheden 39/66/82 m/min. **via transmissie** schakelbaar

■ Tandwieloverbrenging

■ Verplaatsbare zaaggeleiding

■ Hydraulische daalcilinder

■ Mobiel



ZAAGCAPACITEIT				
0°	6	Ø 180 mm	4	180 x 340 mm 65 x 300 mm
45°	6	Ø 130 mm	4	120 x 110 mm

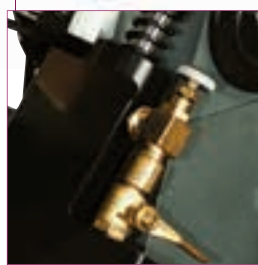

■ Met hydraulische tegendrukcilinder voor traploos instelbare dalingsnelheid.

Standaard geleverd met :

- Mobiele sokkel,
- Koelpomp
- Bi-metalen zaagblad
- materiaalaanslag.
- Nederlandstalige handleiding, opschriften, CE - kenmerk, en CE-attest volgens Machine richtlijn 2006/42/CE, Laagspanningsrichtlijn 2006/95/CE en EMC Richtlijn 2004/108/CE



OPTIMUM

Stationaire, robuuste bandzaagmachine onder hoek verstelbaar met 1 of 2 zaagsnelheden.

- Tandwieloverbrenging
- met 1 zaagsnelheid 68 m/min (1x230V)
- met 2 instelbare zaagsnelheden 40 / 80 m/min (3x400V)
- Grote zaagcapaciteit door zaagbeugel en groot gedimensioneerde loopwielen
- Zaagvoeding door traploos regelbare hydraulische cilinder
- Zagen onder verstek mogelijk dank zij het in het verstek plaatsen van de zaagbeugel van 0° tot 45°.
- Stabiele gietijzeren spanklem met snelspan klemming.
- Robuuste machineonderstel garandeert stabiliteit.
- Precisie afwerking volgens Optimum normen.
- Automatische afslag na het einde van de zaagcyclus.
- Ergonomisch bedieningspaneel met aparte noodstop, aparte start en stopknop.
- Krachtige terughaalveer
- 5-punts kogelgelageerde zaagbladgeleiding.
- Directe, instelbare koeling op het zaagblad.
- Met ingebouwde koelpomp.
- Krachtige en stille motor.
- Zaagborstel voor het reinigen van het zaagblad
- Andere voltages: 3x220V en 3x440V op aanvraag.

Order nr.		713300212	713300210
Orig. nr.		S210G-230V	S210G-400V
Vermogen			
Spanning	V	1x230	3x400
Vermogen motor	kW	0,75	0,75
Vermogen motor koelpomp	W	40	40
Afmetingen			
Zaagsnelheid	m/min	68	40/80
Afmetingen zaaglint (l x h x d)	mm	2080x20x0,90	2080x20x0,90
Opheffen zaagbeugel		Manueel	Manueel
Lengte met gesloten spanklem	mm	1.200	1.200
Lengte met geopende spanklem	mm	1.310	1.310
Breedte zonder materiaalaanslag	mm	510	510
Breedte met materiaalaanslag	mm	685	685
Hoogte onderste eindpositie zaagbeugel	mm	1.300	1.300
Hoogte bovenste eindpositie zaagbeugel	mm	1.700	1.700
Gewicht	kg	160,00	152,00
Afmetingen (l x b x h)	mm		1300 x 580 x 900
Prijs	€	1.550,00	1.549,00

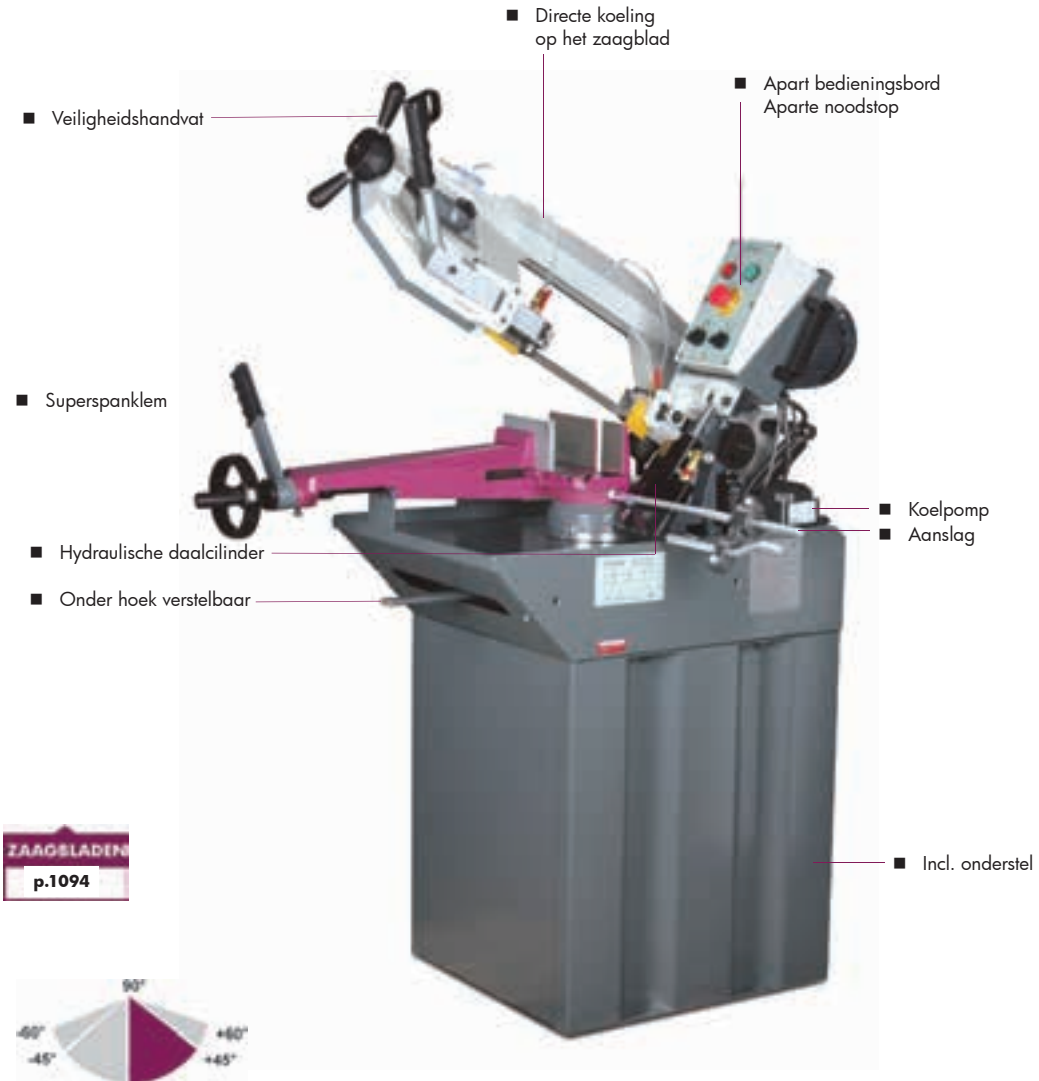

ZAAGSLADEN
p.1094



ZAAGCAPACITEIT				
0°		Ø 170 mm		210 x 140 mm
45°		Ø 135 mm		125 x 100 mm

Standaard geleverd met :

- Sokkel,
- Koelpomp
- Bi-metalen zaagblad
- Materiaalaanslag,
- Nederlandstalige handleiding, opschriften, CE - kenmerk, en CE-attest volgens Machine richtlijn 2006/42/CE, Laagspanningsrichtlijn 2006/95/CE en EMC Richtlijn 2004/108/CE

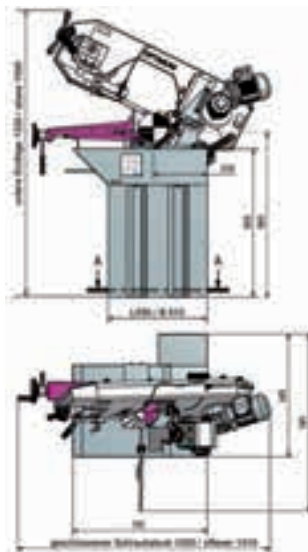

OPTIMUM

Stationaire, robuuste bandzaagmachine onder hoek verstelbaar tot 60° met 2 zaagsnelheden en in Vario uitvoering.

- Beste prijs-kwaliteitsverhouding voor zaagmachine **met zaagblad hoogte 27 mm**
- met 2 instelbare zaagsnelheden 45 / 90 m/min (3x400V)
- Variabele zaagsnelheden 20 – 90 m/min (enkel Vario op 1x230V)
- Variabele zaagsnelheden 12 – 120 m/min (enkel Vario op 3x400V met **LENZE technologie**)
- Grote zaagcapaciteit door zaagbeugel en groot gedimensioneerde loopwielen
- Zaagvoeding door traploos regelbare hydraulische cilinder
- Zagen onder verstek mogelijk dank zij het in het verstek plaatsen van de zaagbeugel van 0° tot 60°.
- Stabiele gietijzere spanklem met snelspan klemming.
- Zaagbladspanning duidelijk afleesbaar door geïnstalleerde manometer.
- Robuuste machineonderstel garandeert stabiliteit.
- Ergonomische geplaatst bedieningsbord met aparte noodstop, aparte start-stopknop, koelmiddelschakelaar en keuzeschakelaar
- twee snelheden of potentiometer (enkel Vario modellen)
- Precisie afwerking volgens Optimum normen.
- Automatische afslag na het einde van de zaagcyclus.
- Krachtige terughaalveer
- 5-punts kogelgelageerde zaagbladgeleiding.
- Directe, instelbare koeling op het zaagblad.
- Met ingebouwde koelpomp.
- Krachtige en stille motor.
- Zaagborstel voor het reinigen van het zaagblad
- Andere voltages: 3x220V (713300277) en 3x440V op aanvraag.

Order nr.	713290278 ^M	713300275 ^M	713012275 ^M
Orig. nr.	S275G-230V VARIO	S275G	S275G-400V VARIO
Vermogen			
Spanning	V	1x230	3x400
Vermogen motor	kW	1,5	1,1
Vermogen motor koelpomp	W	50	50
Afmetingen			
Zaagsnelheid	m/min	20-90	45/90
Afmetingen zaaglint (l x h x d)	mm	2480x27x0,90	2480x27x0,90
Opheffen zaagbeugel		Manueel	Manueel
Lengte met gesloten spanklem	mm	1.360	1.360
Lengte met geopende spanklem	mm	1.700	1.700
Breedte zonder materiaal aanslag	mm	510	510
Breedte met materiaal aanslag	mm	985	985
Hoogte onderste eindpositie zaagbeugel	mm	1.420	1.360
Hoogte bovenste eindpositie zaagbeugel	mm	1.570	1.700
Gewicht	kg	185,00	205,00
Afmetingen (l x b x h)	mm	1360 x 580 x 900	1360 x 580 x 880
Prijs	€	1.990,00	1.799,00
			3.690,00

S275G



■ Inclusief manometer

■ Zaagbladhoogte 27 mm

■ Apart bedieningsbord

■ Snelpanchroef

■ S275G - 400V

■ Onder hoek verstelbaar

■ Hydraulische daalcilinder

ZAAGBLADEN
p.1094



■ Koelpomp

ZAAGCAPACITEIT			
60°		Ø 225 mm	245 x 180 mm
45°		Ø 160 mm	180 x 180 mm
60°		Ø 100 mm	120 x 120 mm

Standaard geleverd met :

- Sokkel
- Koelpomp
- Bi-metalen zaagblad
- Materiaalaanslag.
- Nederlandstalige handleiding, opschriften, CE - kenmerk, en CE-attest volgens Machine richtlijn 2006/42/CE, Laagspanningsrichtlijn 2006/95/CE en EMC Richtlijn 2004/108/CE



Stationaire, robuuste bandzaagmachine **onder dubbel verstek van -45° tot +60°** met 2 zaagsnelheden.

- Beste prijs-kwaliteitsverhouding voor zaagmachine met zaagblad hoogte 27 mm
- met 2 instelbare zaagsnelheden 45 / 90 m/min (3x400V)
- Grote zaagcapaciteit door zaagbeugel en groot gedimensioneerde loopwielen
- Zaagvoeding door traploos regelbare hydraulische cilinder
- Zagen onder verstek mogelijk dankzij het in het verstek plaatsen van de zaagbeugel van -45° tot +60°.
- Stabiele gietijzere spanklem met snelspan klemming.
- Zaagbladspanning duidelijk afleesbaar door geïnstalleerde manometer.
- Robuuste machineonderstel garandeert stabiliteit.
- Ergonomische geplaatst bedieningsbord met aparte noodstop, aparte start-stopknop, koelmiddelschakelaar en keuzeschakelaar twee snelheden
- Precisie afwerking volgens Optimum normen.
- Automatische afslag na het einde van de zaagcyclus.
- Krachtige terughaalveer
- 5-punts kogelgelageerde zaagbladgeleiding.
- Directe, instelbare koeling op het zaagblad.
- Met ingebouwde koelpomp.
- Krachtige en stille motor.
- Andere voltages: 3x220V en 3x440V op aanvraag.

Order nr.		713300285
Orig. nr.		S285DG
Vermogen		
Spanning	V	3x400
Vermogen motor	kW	1,1
Vermogen motor koelpomp	W	100
Afmetingen		
Zaagsnelheid	m/min	45/90
Afmetingen zaaglint (l x h x d)	mm	2480x27x0,90
Ophffen zaagbeugel		Manueel
Lengte met gesloten spanklem	mm	1.400
Lengte met geopende spanklem	mm	1.700
Breedte zonder materiaal aanslag	mm	870
Breedte met materiaal aanslag	mm	1.270
Hoogte onderste eindpositie zaagbeugel	mm	1.280
Hoogte bovenste eindpositie zaagbeugel	mm	1.800
Gewicht	kg	295,00
Afmetingen (l x b x h)	mm	1460 x 730 x 1060
Prijs	€	2.790,00

DUBBEL VERSTEK
links en rechts



■ Inclusief manometer

- Aparte startknop
- Aparte stopknop
- Aparte noodstop
- Schakelaar koelpomp
- 2 snelheden schakelaarmotor

■ Regelbare
daalvoeding bij
het bedieningspaneel



■ Koelpomp

■ Aanslag

■ Ondersteuningsrol

■ Dubbel verstek



ZAAGCAPACITEIT		
	0°	60°
	ø 200 mm	ø 90 mm
	245 x 150 mm	80 x 110 mm
	-45°	45°
	ø 130 mm	ø 100 mm
	100 x 140 mm	145 x 215 mm

ZAAGSLADENS
p.1094

Standaard geleverd met :

- Sokkel,
- Koelpomp
- Bi-metalen zaagblad
- Materiaalaanslag,
- Nederlandstalige handleiding, opschriften, CE - kenmerk, en CE-attest volgens Machine richtlijn 2006/42/CE, Laagspanningsrichtlijn 2006/95/CE en EMC Richtlijn 2004/108/CE



OPTIMUM

Stationaire, robuuste bandzaagmachine onder **dubbel verstek van -45° tot +60°** met 2 zaagsnelheden of variabele zaagsnelheden 20 – 90 m/min .

- met 2 instelbare zaagsnelheden 35 / 70 m/min
- met variabele zaagsnelheden 20 – 90 m/min (Vario model)
- Grote zaagcapaciteit door zaagbeugel en groot gedimensioneerde loopwielen
- **Regelbare daalvoeding in paneel**, alsook een tweede noodstop.
- Zagen onder verstek mogelijk dankzij het in het verstek plaatsen van de zaagbeugel van -45° tot +60°.
- Stabiele gietijzeren spanklem met snelspan klemming.
- Zaagbladspanning duidelijk afleesbaar door geïnstalleerde manometer.
- Robuuste machineonderstel garandeert stabiliteit.
- Aan de linkerzijde geïnstalleerde ondersteuningsrol, voor het ondersteunen van langere werkstukken.
- Ergonomische geplaatst bedieningsbord met aparte noodstop, , aparte start-stopknop, koelmiddelschakelaar en keuzeschakelaar twee snelheden of potentiometer (enkel Vario modellen), afsluitbare hoofdschakelaar, keuzeschakelaar (manueel of in cyclus)
- Precisie afwerking volgens Optimum normen.
- Automatische afslag na het einde van de zaagcyclus.
- Krachtige terughaalveer
- 5-punts kogelgelagete zaagbladgeleiding.
- Directe, instelbare koeling op het zaagblad.
- Met ingebouwde koelpomp.
- Krachtige en stille motor.
- Voorzien van een zaagborstel voor het reinigen van het zaagblad
- Andere voltages: 3x220V en 3x440V op aanvraag.

Order nr.		713290290	713290295
Orig. nr.		S300DG	S300DG VARIO
Vermogen			
Spanning	V	3x400	3x400
Vermogen motor	kW	1,5	1,5
Vermogen motor koelpomp	W	100	100
Afmetingen			
Zaagsnelheid	m/min	35/70	20-90
Afmetingen zaaglint (l x h x d)	mm	2750x27x0,9	2750x27x0,9
Opheffen zaagbeugel		Manueel	Manueel
Lengte met gesloten spanklem	mm	1.400	1.400
Lengte met geopende spanklem	mm	1.700	1.700
Breedte zonder materiaalaanslag	mm	700	700
Breedte met materiaalaanslag	mm	1.300	1.300
Hoogte onderste eindpositie zaagbeugel	mm	1.600	1.600
Hoogte bovenste eindpositie zaagbeugel	mm	1.850	1.850
Gewicht	kg	335,00	335,00
Afmetingen (l x b x h)	mm	1720 x 730 x 1130	1720 x 730 x 1130
Prijs	€	3.390,00	3.690,00



Stationaire, robuuste bandzaagmachine met draaitafel onder dubbel verstek van -45° tot $+60^\circ$ met **variabele zaagsnelheden 20 – 90 m/min**.

- met variabele zaagsnelheden 20 – 90 m/min
- Zware gietijzeren uitvoering
- Hoge zaagnauwkeurigheid door trillingsvrij zagen
- Grote zaagcapaciteit door zaagbeugel en groot gedimensioneerde loopwielen
- Regelbare dalvoeding in paneel, alsook een tweede noodstop
- Zagen onder verstek mogelijk dankzij het in het verstek plaatsen van de zaagbeugel van -45° tot $+60^\circ$.
- **Degelijke gradenboog met grote schaalverdeling**, zodat u een precieze hoekinstelling kunt verkrijgen
- Stabiele gietijzeren spanklem met snelspan klemming.
- Zaagbladspanning duidelijk afleesbaar door geïnstalleerde manometer.
- Robuuste machineonderstel garandeert stabiliteit.
- Aan de linkerkant geïnstalleerde ondersteuningsrol, voor het ondersteunen van langere werkstukken.
- Ergonomische geplaatst bedieningsbord met aparte noodstop, , aparte start-stopknop, koelmiddelschakelaar en potentiometer, afsluitbare hoofdschakelaar, keuzeschakelaar (manueel of in cyclus)
- Precisie afwerking volgens Optimum normen.
- Automatische afslag na het einde van de zaagcyclus.
- Twee krachtige terughaalveren
- 5-punts kogelgelagerde zaagbladgeleiding.
- Directe, instelbare koeling op het zaagblad.
- Met ingebouwde koelpomp.
- Krachtige en stille motor.
- Voorzien van een zaagborstel voor het reinigen van het zaagblad

Order nr.		713290335
Orig. nr.		S310DG VARIO
Vermogen		
Spanning	V	3x400
Vermogen motor	kW	1,5
Vermogen motor koelpomp	W	100
Afmetingen		
Zaagsnelheid	m/min	20-90
Afmetingen zaaglint (l x h x d)	mm	2750x27x0,9
Ophffen zaagbeugel		Manueel
Lengte met gesloten spanklem	mm	1.400
Lengte met geopende spanklem	mm	1.680
Breedte zonder materiaal aanslag	mm	700
Breedte met materiaal aanslag	mm	1.330
Hoogte onderste eindpositie zaagbeugel	mm	1.600
Hoogte bovenste eindpositie zaagbeugel	mm	2.000
Gewicht	kg	380,00
Afmetingen (l x b x h)	mm	1720 x 730 x 1130
Prijs	€	4.290,00

S310DG

VARIO **DUBBEL VERSTEK**
links en rechts

■ Inclusief manometer

■ Regelbare
daalvoeding
in bedieningspaneel

■ Vario

■ Koelpomp



■ Zaagbeugel en
gradenverdeling
verdraaien simultaan

ZAAGCAPACITEIT	
90°	60°
⊘ 255 mm	⊘ 115 mm
315 x 230 mm	125 x 160 mm
230 mm	125 mm
-45°	+45°
⊘ 195 mm	⊘ 160 mm
195 x 230 mm	160 x 160 mm
160 mm	160 mm

ZAAGSLADEN
p.1094

Standaard geleverd met :

- Sokkel,
- Koelpomp
- Bi-metalen zaagblad
- Materiaalaanslag 500 mm met mm schaalverdeling.
- Spanen opvangbak
- Nederlandstalige handleiding, opschriften, CE - kenmerk, en CE-attest volgens Machine richtlijn 2006/42/CE, Laagspanningsrichtlijn 2006/95/CE en EMC Richtlijn 2004/108/CE

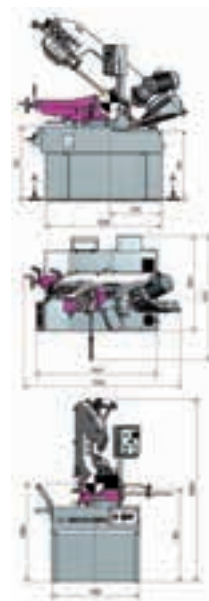

OPTIMUM

Stationaire, robuuste bandzaagmachine onder dubbel verstek van -45° tot $+60^\circ$ met twee zaagsnelheden.

- met 2 zaagsnelheden 36 - 72 m/min dankzij tweesnelheidsmotor
- Zware gietijzeren uitvoering
- **Grote zaagcapaciteit** door zaagbeugel en groot gedimensioneerde loopwielen
- Regelbare daarvoeding in paneel, alsook een tweede noodstop
- Zagen onder verstek mogelijk dankzij het in het verstek plaatsen van de zaagbeugel **van -45° tot $+60^\circ$** .
- Stabiele gietijzeren spanklem met snelspan klemming.
- Zaagbladspanning duidelijk afleesbaar door geïnstalleerde manometer.
- Robuuste machineonderstel garandeert stabiliteit.
- Aan de linkerkant geïnstalleerde ondersteuningsrol, voor het ondersteunen van langere werkstukken.
- Tweetrapsoverbrenging van de motor voor krachtige overbrenging van het motorvermogen.
- Krachtige en stille motor.
- Ergonomische geplaatst bedieningsbord met aparte noodstop, aparte start-stopknop, koelmiddelschakelaar en keuzeschakelaar twee snelheden, afsluitbare hoofdschakelaar, keuzeschakelaar (manueel of in cyclus)
- Precisie afwerking volgens Optimum normen.
- Automatische afslag na het einde van de zaagcyclus.
- Twee krachtige terughaalveren
- 5-punts kogelgelageerde zaagbladgeleiding.
- Directe, instelbare koeling op het zaagblad.
- Met ingebouwde koelpomp.
- Voorzien van een zaagborstel voor het reinigen van het zaagblad
- Andere voltages: 3x220V en 3x440V op aanvraag.

Order nr.		713290350
Orig. nr.		S350DG
Vermogen		
Spanning	V	3x400
Vermogen motor	kW	2,2
Vermogen motor koelpomp	W	50
Afmetingen		
Zaagsnelheid	m/min	36/72
Afmetingen zaaglint (l x h x d)	mm	2925x27x0,9
Ophffen zaagbeugel		Manueel
Lengte met gesloten spanklem	mm	1.500
Lengte met geopende spanklem	mm	1.750
Breedte zonder materiaal aanslag	mm	1.075
Breedte met materiaal aanslag	mm	1.415
Hoogte onderste eindpositie zaagbeugel	mm	1.420
Hoogte bovenste eindpositie zaagbeugel	mm	1.800
Gewicht	kg	550,00
Afmetingen (l x b x h)	mm	1930 x 970 x 1120
Prijs	€	4.795,00

S350DG



- Inclusief manometer

DUBBEL VERSTEK
links en rechts



- Koelpomp

- Krachtige terughaalveren

- Lengte aanslag

- Koelpomp

- Regelbare
daalvoeding in
bedieningspaneel

- Links / rechts onder
hoek verstelbaar



ZAAGBLADEN
p.1094

ZAAGCAPACITEIT			
90°	Ø 100 mm	Ø 100 mm	Ø 100 mm
80°	Ø 100 mm	Ø 100 mm	Ø 100 mm
45°	Ø 100 mm	Ø 100 mm	Ø 100 mm
+45°	Ø 100 mm	Ø 100 mm	Ø 100 mm

Standaard geleverd met :

- Sokkel,
- Koelpomp
- Bi-metalen zaagblad
- Materiaalaanslag 500 mm met mm schaalverdeling.
- Spanen opvangbak
- Nederlandstalige handleiding, opschriften, CE - kenmerk, en CE-attest volgens Machine richtlijn 2006/42/CE, Laagspanningsrichtlijn 2006/95/CE en EMC Richtlijn 2004/108/CE



CNC gestuurde automatische metaal bandzaagmachine met ingebouwde frequentieomvormer 20 - 100 m/min.

- Productiezaagmachine voor het automatische zagen van RVS en werktuigstaal, profiel, zowel hol als vol materiaal.
- Bedieningspaneel met modi om zowel halfautomatisch als volautomatisch te werken.
- Werkingwijze CNC automatische bediening: het is mogelijk verschillende ingaven te programmeren. Het programma houdt per ingave het aantal te zagen stukken en de gewenste zaag lengtes bij. Het aantal stappen van de aanvoerlengtes worden automatisch berekend door de processor. Het is mogelijk verschillende zaagsneden op te roepen en een programma van verschillende zaagsneden na elkaar te laten uitvoeren. Keuze uit 9 programma's. Bovendien voorzien van volgende informatie weergave: toestand van de zaag, actuele positie van de bewegende machineklem, werkstuk / zaagsnedenteller, gekozen lengte van de kopzaagsnede. Met TOL kan de instelling van de gewenste tolerantie bekomen worden.
- Automatische bandzaagmachine, hydraulisch gestuurde functies: zakken en stijgen van de zaagbeugel zijn eenvoudig bedienbaar vanaf het bedieningsbord met drukknoppen, alsook het openen en het sluiten van de vaste machineklem, als van de beweegbare machineklem.
- Hydro - dynamische zaagbladspanning afleesbaar via bedieningsbord door indicatielamp
- Zaagarm staat onder 25°, wat een hogere stabiliteit van het zaagblad garandeert.
- Bandzaag met een hoogte van 27 mm: hoe hoger de bandzaag, hoe langer deze het contact behoudt met het te zagen materiaal en hoe rechter de bekomen zaagsnede.
- Uiterst met een inverter, waardoor het mogelijk wordt traploos snelheden te kiezen tussen 20 en 100 m/min. Hierdoor kunnen verschillende materiaalsoorten worden gezaagd, zoals roestvrij staal.
- Zware 2,2 kW motor biedt u genoeg power voor het zwaardere werk met overbelastingsbeveiliging
- Groot gedimensioneerde; oliegesmeerde transmissie.
- Onder hoek verstelbaar tot 60°, met gradenverdeling.
- Uiterst robuuste bandzaagmachine met dikke plaatstalen onderconstructie (800 kg).
- Regelbaar koelvloeistofsysteem met directe koeling doorheen beide zaaggeleidingen op de bandzaag.
- Overgedimensioneerde rollagers op beide zaaggeleidingen en dit langs beide zijden van de bandzaag, bovendien uitgerust met grote hardmetalen geleidingsplaatjes; zo wordt de zaag perfect geleid.
- De bandzaag wordt continu gereinigd door een zaagborstel.
- Binnen in de zaagbeugel zitten twee grote loopwielen voorzien van sterke lagers.
- Voorzien van een zaagbreuk beveiliging
- Aanvoerhoogte machineklem 940 mm
- De kap van de zaagbeugel is uitgerust met een microscharnelaar, bij openen valt de machine stil en bij openen elektrische kast valt de machine eveneens uit. Tevens zijn de zaaggeleidingen afgeschermd.
- Aan- en afvoerrollbanen op aanvraag.

Order nr.

713690045 M

Orig. nr.

BMBS240X280 CNC-GF

Vermogen

Spanning
Vermogen motor

V 3x400
kW 2,2

Afmetingen

Zaagsnelheid
Afmetingen zaaglint (l x h x d)
Ophieven-dalen zaagbeugel
Openen-sluiten spanklem
Werkhoogte
Maximum aanvoerlengte in l x aanvoer
Minimum restweg in automatische modus
Minimum restweg in manuele modus
Gewicht
Afmetingen (l x b x h)

m/min 20/100
mm 2980x27x0,90
Hydraulisch
Hydraulisch
mm 940
mm 500
mm 170 + 20
mm 60
kg 800,00
mm 2200 x 2150 x 1900

Prijs

€ 16.900,00

BMBS240x280 CNC-G-F



■ 25° gekantelde zaagarm

■ Krachtige oliegesmeerde overbrenging

■ Tot 60° onder hoek verstelbaar



ZAAGBLADEN

p.1094

KOELMELK

p.1075



ZAAGCAPACITEIT

	45°	60°	90°	120°
Ø	150	150	150	150
Ø	150	150	150	150
Ø x L	200 x 220	200 x 220	200 x 220	200 x 220
Ø x L	200 x 220	200 x 220	200 x 220	200 x 220

Standaard geleverd met :

- Koelpomp
- Bi-metalen zaagblad
- Nederlandstalige handleiding, opschriften, CE - kenmerk, en CE-attest volgens Machine richtlijn 2006/42/CE, Laagspanningsrichtlijn 2006/95/CE en EMC Richtlijn 2004/108/CE



CNC gestuurde automatische metaal bandzaagmachine met ingebouwde frequentieomvormer 20 - 100 m/min en **dubbel verstek**.

- Productiezaagmachine voor het automatische zagen van RVS en werktuigstaal, profiel, zowel hol als vol materiaal.
- Bedieningspaneel met modi om zowel halfautomatisch als volautomatisch te werken.
- Werkingwijze CNC automatische bediening: het is mogelijk verschillende ingaven te programmeren. Het programma houdt per ingave het aantal te zagen stukken en de gewenste zaaglengtes bij. Het aantal stappen van de aanvoerlengtes worden automatisch berekend door de processor. Het is mogelijk verschillende zaagsneden op te roepen en een programma van verschillende zaagsneden na elkaar te laten uitvoeren. Keuze uit 9 programma's. Bovendien voorzien van volgende informatie weergave: toestand van de zaag, actuele positie van de bewegende machineklem, werkstuk / zaagsnedenteller, gekozen lengte van de kopzaagsnede. Met TOL kan de instelling van de gewenste tolerantie bekomen worden.
- Automatische bandzaagmachine, hydraulisch gestuurde functies: zakken en stijgen van de zaagbeugel zijn eenvoudig bedienbaar vanaf het bedieningsbord met drukknoppen, alsook het openen en het sluiten van de vaste machineklem, als van de beweegbare machineklem.
- Hydro - dynamische zaagbladspanning afleesbaar via bedieningsbord door indicatielamp
- Zaagarm staat onder 25°, wat een hogere stabiliteit van het zaagblad garandeert.
- Bandzaag met een hoogte van 27 mm: hoe hoger de bandzaag, hoe langer deze het contact behoudt met het te zagen materiaal en hoe rechter de bekomen zaagsnede.
- Uiterst met een inverter, waardoor het mogelijk wordt traploos snelheden te kiezen tussen 20 en 100 m/min. Hierdoor kunnen verschillende materiaalsoorten worden gezaagd, zoals roestvrij staal.
- Zware 2,2 kW motor biedt u genoeg power voor het zwaardere werk met overbelastingsbeveiliging
- Groot gedimensioneerde; oliegesmeerde transmissie.
- Onder hoek verstelbaar -45° tot 60°, met grote en degelijke gradenverdeling.
- Uiterst robuuste bandzaagmachine met dikke plaatstalen onderconstructie (880 kg).
- Regelbaar koelvloeistofsysteem met directe koeling doorheen beide zaaggeleidingen op de bandzaag.
- Overgedimensioneerde rollagers op beide zaaggeleidingen en dit langs beide zijden van de bandzaag, bovendien uitgerust met grote hardmetalen geleidingsplaatjes; zo wordt de zaag perfect geleid.
- De bandzaag wordt continu gereinigd door een zaagborstel.
- Binnen in de zaagbeugel zitten twee grote loopwielen voorzien van sterke lagers.
- Voorzien van een zaagbreuk beveiliging
- Aanvoerhoogte machineklem 945 mm
- De kap van de zaagbeugel is uitgerust met een microscharnelaar, bij openen valt de machine stil en bij openen elektrische kast valt de machine eveneens uit. Tevens zijn de zaaggeleidingen afgeschermd.
- Aan- en afvoerrollbanen op aanvraag.

Order nr.	713690054 M	
Orig. nr.	BMBS290X290 CNC-GF	
Vermogen		
Spanning	V	3x400
Vermogen motor	kW	2,2
Afmetingen		
Zaagsnelheid	m/min	20/100
Afmetingen zaaglint (l x h x d)	mm	3100x27x0,90
Opheffen-dalen zaagbeugel		Hydraulisch
Openen-sluiten spanklem		Hydraulisch
Werkhoogte	mm	945
Maximum aanvoerlengte in l x aanvoer	mm	500
Minimum restweg in automatische modus	mm	280 + 20
Minimum restweg in manuele modus	mm	50
Gewicht	kg	880,00
Afmetingen (l x b x h)	mm	1950 x 2250 x 2100
Prijs	€	18.940,00

BMBS290X290 CNC-DG-F





■ 25° gekantelde zaagarm



■ Oliegesmeerde overbrenging

■ Degelijke gradenboog verdeling





 p.1094

ZAAGCAPACITEIT					
mm	 0°	 45°	 60°	 45°	 90°
	290	240	150	240	X
	180 *	110 *	80 *	180 *	X
 x x h	370 x 290	240 x 150	150 x 180	240 x 100	370 x 160
 x x h	370 x 290	210 x 290	130 x 290	150 x 290	370 x 160

Standaard geleverd met :

- Koelpomp
- Bi-metalen zaagblad
- Nederlandstalige handleiding, opschriften, CE - kenmerk, en CE-attest volgens Machine richtlijn 2006/42/CE, Laagspanningsrichtlijn 2006/95/CE en EMC Richtlijn 2004/108/CE



VMBS. Verticale metaal bandzaagmachine in een solide structuur met laseenheid, E modellen met elektrische tafelvoeding.

- Uiterst stabiele bouwstructuur, volledige machinelichaam uit staal
- Gebruiksvriendelijke bedieningspaneel met degelijke werkplaatsverlichting
- Neigbare werktafel uit grijsgietijzer
- Traploos regelbare zaagsnelheden
- Spanen eenvoudig verwijderen door wegblazen
- Zaagbladspanning en zaagbladsnelheidweergave
- De ingebouwde laseenheid (snijden, slijpen en verlassen) maakt het herstellen en op lengte aanmaken van nieuwe zaagbladen vanaf rol mogelijk.

VMBS1610, VMBS1610E, VMBS2012HE:

- 2-traps overbrenging

VMNBS1408E, VMBS1610E, VMBS2012HE:

- Met elektrische tafelvoeding

Order nr.	713951610	
Orig. nr.	VMBS1610	
Uitlading	mm	396
Maximum snijhoogte	mm	255
Hellingshoek werktafel links/rechts	°	12/15
Hellingshoek werktafel voor/achter	°	8/8
Zaagbandlengte	mm	3140
Maximum zaagbandbreedte	mm	16
Zaagsnelheid (1ste gang)	m/min	20-80
Zaagsnelheid (2de gang)	m/min	250-1000
Maximum zaagbandbreedte laseenheid	mm	16
Werkhoogte	mm	1000
Vermogen motor	kW	1,5
Motor	V	3x400
Tafelafmetingen	mm	550x600
Gewicht	kg	410,00
Afmetingen (l x b x h)	mm	940 x 675 x 1840
Prijs	€	5.300,00

VMBS1610

ZAAGBLADEN VARIO 410kg
p.1094



Bedieningspaneel



■ Ingebouwde lasseenheid

Standaard geleverd met :

- aanslag
- zonder zaagblad.



Halfautomatische metaal bandzaagmachine met grote draaitafel en variabele zaagsnelheden 20 – 90 m/min

- **Halfautomatische bandzaagmachine**, hydraulisch gestuurde functies: zakken en stijgen van de zaagbeugel zijn eenvoudig bedienbaar vanaf het bedieningsbord, alsook de openen en sluiten van de machineklem met een keuzeschakelaar
- Hydramechanische zaagbladspanning afleesbaar over een manometer
- Bandzaag met een hoogte van 27 mm: hoe hoger de bandzaag, hoe langer deze het contact behoudt met het te zagen materiaal en hoe rechter de bekomen zaagsnede.
- Gietijzeren zaagbeugel garandeert optimale stabiliteit.
- Uitgerust **met een inverter**, waardoor het mogelijk wordt traploos snelheden te kiezen tussen 20 en 90 m/min. Hierdoor kunnen verschillende materiaalsoorten worden gezaagd, zoals roestvrij staal.
- Zware 1.5 kW motor biedt u genoeg power voor het zwaardere werk met overbelastingsbeveiliging
- Oliegesmeerde transmissie.
- Automatische afslag en terugkeer van de zaagbeugel, voorzien van twee eindeeloo schakelaars om hoogste en laagste positie in te stellen.
- Onder hoek verstelbaar zowel **links als rechts van -45° tot +60°**, met duidelijk afleesbare gradenverdeling.
- Uiterst robuuste bandzaagmachine met dikke plaatstalen onderconstructie (500 kg).
- Regelbaar koelvloeistofsysteem met directe koeling doorheen beide zaaggeleidingen op de bandzaag.
- Overgedimensioneerde rollagers op beide zaaggeleidingen en dit langs beide zijden van de bandzaag, bovendien uitgerust met grote hardmetalen geleidingsplaatjes; zo wordt de zaag perfect geleid.
- Krachtige compensatieveer houdt de zaagbeugel stabiel.
- De bandzaag wordt continu gereinigd door een zaagborstel.
- Binnen in de zaagbeugel zitten twee grote loopwielen voorzien van sterke lagers.
- Ergonomisch geplaatst bedieningspaneel met aparte noodstop, aparte start/stop knop, vergrendelbare hoofdschakelaar, koelmiddelschakelaar, potentiometer, drukknoppen voor heffen en dalen zaagbeugel
- De kap van de zaagbeugel is uitgerust met een microscharnelaar, bij openen valt de machine stil en bij openen elektrische kast valt de machine eveneens uit. Tevens zijn de zaaggeleidingen afgeschermd.
- Andere voltages: 3x220V en 3x440V op aanvraag.

Standaard geleverd met

- Sokkel
- Koelpomp
- Bi-metalen zaagblad
- materiaal aanslag 500 mm met mm schaalverdeling.
- Nederlandstalige handleiding, opschriften, CE - kenmerk, en CE-attest volgens Machine richtlijn 2006/42/CE, Laagspanningsrichtlijn 2006/95/CE en EMC Richtlijn 2004/108/CE

Order nr.	800170702	
Orig. nr.	BZH220X280H VARIO	
Vermogen		
Spanning	V	3x400
Vermogen motor	kW	1,5
Vermogen motor koelpomp	W	120
Vermogen hydraulische motor	W	370
Afmetingen		
Zaagsnelheid	m/min	25-90
Afmetingen zaaglint (l x h x d)	mm	3000x27x0,90
Opheffen-dalen zaagbeugel		Hydraulisch
Openen-sluiten spanklem		Hydraulisch
Gewicht	kg	524,00
Afmetingen (l x b x h)	mm	1660 x 840 x 1510
Prijs	€	5.950,00

BZH220X280H VARIO

1,5KW VARIO DUBBEL VERSTEK ZAAGBLADEN

p.1094

- Hydromechanische zaagbladspanning afleesbaar over een manometer

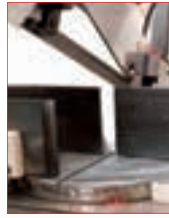

- Duidelijk afleesbare gradenverdeling

- Drukregeling machineklem



- Aparte start / stopknop, Potentiometer zaag snelheden, Keuzeschakelaar dalen en slijgen zaagbeugel, Draaiknop voor zaagvoeding



- Regeling dalvoeding



ZAAGCAPACITEIT

0°		∅ 220 mm		220 mm		200 x 280 mm
45°		∅ 200 mm		200 mm		200 x 220 mm
60°		∅ 130 mm		120 mm		120 x 120 mm
-45°		∅ 220 mm		220 mm		220 x 220 mm



Standaard geleverd met :

- Sokkel
- Koelpomp
- Bi-metalen zaagblad
- materiaalaanslag 500 mm met mm schaalverdeling.
- Nederlandse handleiding, opschriften, CE - kenmerk, en CE-attest volgens Machine richtlijn 2006/42/CE, Laagspanningsrichtlijn 2006/95/CE en EMC Richtlijn 2004/108/CE



METALWORK

Halfautomatische metaal bandzaagmachine met grote zaagcapaciteit en variabele zaagsnelheden 20 – 90 m/min

- **Halfautomatische** bandzaagmachine, hydraulisch gestuurde functies: zakken en stijgen van de zaagbeugel zijn eenvoudig bedienbaar vanaf het bedieningsbord met drukknoppen, alsook het openen en het sluiten van de machineklem.
- Hydramechanische zaagbladspanning afleesbaar over een manometer
- Bandzaag met een hoogte van 27 mm: hoe hoger de bandzaag, hoe langer deze het contact behoudt met het te zagen materiaal en hoe rechter de bekomen zaagsnede.
- Uitgerust **met een inverter**, waardoor het mogelijk wordt traploos snelheden te kiezen tussen 20 en 90 m/min. Hierdoor kunnen verschillende materiaalsoorten worden gezaagd, zoals roestvrij staal.
- Zware 2,2 kW motor biedt u genoeg power voor het zwaardere werk met overbelastingsbeveiliging
- Oliegesmeerde transmissie.
- Beschikt eveneens over **variabele drukregeling** van de machineklem, hierdoor kunnen ook nog steeds dünnere materialen gezaagd worden zonder dat deze worden vervormd door de zware gietijzeren machineklem.
- Onder hoek verstelbaar tot 60°, met duidelijk afleesbare gegraveerde gradenverdeling.
- Uiterst robuuste bandzaagmachine met dikke plaatstalen onderconstructie (935 kg).
- Regelbaar koelvoelstofsysteem met directe koeling doorheen beide zaaggeleidingen op de bandzaag.
- Voorzien langs de aanvoerzijde van een extra ondersteuningsrol, hierdoor kan het materiaal eenvoudig worden aangevoerd.
- Overgedimensioneerde rollagers op beide zaaggeleidingen en dit langs beide zijden van de bandzaag, bovendien uitgerust met grote hardmetalen geleidingsplaatjes; zo wordt de zaag perfect geleid.
- Twee krachtige compensatieveren houden de zaagbeugel stabiel.
- De bandzaag wordt continu gereinigd door een zaagborstel.
- Twee krachtige regelbare ondersteuningsarmen maken dat de zaag recht en onder de correcte spanning blijft staan.
- Binnen in de zaagbeugel zitten twee grote loopwielen voorzien van sterke lagers.
- De hydraulische gietijzeren machineklem is voorzien van afstandsgaten, zodat men efficiënter kan werken en niet de hydraulische slag van de machineklem moet afwachten.
- Voorzien van een zaagbreuk beveiliging
- Aanvoerhoogte machineklem 740 mm
- Ergonomisch geplaatst bedieningspaneel met aparte noodstop, aparte start/stop knop, vergrendelbare hoofdschakelaar, koelmiddelschakelaar, potentiometer, drukknoppen voor heffen en dalen zaagbeugel
- De kap van de zaagbeugel is uitgerust met een microscharnelaar, bij openen valt de machine stil en bij openen elektrische kast valt de machine eveneens uit. Tevens zijn de zaaggeleidingen afgeschermd.
- Andere voltages: 3x220V en 3x440V op aanvraag.
- Rollenbanen op aanvraag

Order nr.	800170705	
Orig. nr.	BZH300X430 VARIO	
Vermogen		
Spanning	V	3x400
Vermogen motor	kW	2,2
Vermogen motor koelpomp	W	120
Vermogen hydraulische motor	W	370
Afmetingen		
Zaagsnelheid	m/min	25-90
Afmetingen zaaglint (l x h x d)	mm	3850x27x0,90
Ophieven-dalen zaagbeugel		Hydraulisch
Openen-sluiten spanklem		Hydraulisch
Gewicht	kg	935,00
Afmetingen (l x b x h)	mm	1300 x 1950 x 1700
Prijs	€	8.490,00

BZH300X430 VARIO

VARIO **ZAAGBLADEN**
p.1094



■ Hydromechanische zaagbladspanning afleesbaar over een manometer

■ Gegraveerde gradenverdeling

■ Groot gedimensioneerd loopwielen

■ Inclusief zaagborstel

■ Inclusief koelpomp

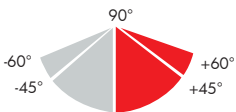

BZH300X430 VARIO ZAAGCAPACITEIT

0°		ø 300 mm		300 mm		240 x 430 mm
45°		ø 280 mm		280 mm		170 x 300 mm
60°		ø 170 mm		170 mm		160 x 170 mm

Standaard geleverd met :

- Sokkel,
- Koelpomp
- Bi-metalen zaagblad
- Materiaalaanslag 500 mm met mm schaalverdeling.
- Rollenbaan van 1.100 mm
- Nederlandstalige handleiding, opschriften, CE - kenmerk, en CE-attest volgens Machine richtlijn 2006/42/CE, Laagspanningsrichtlijn 2006/95/CE en EMC Richtlijn 2004/108/CE



Halfautomatische metaal bandzaagmachine met grote zaagcapaciteit en variabele zaagsnelheden 20 – 90 m/min

- **Halfautomatische** bandzaagmachine, hydraulisch gestuurde functies: zakken en stijgen van de zaagbeugel zijn eenvoudig bedienbaar vanaf het bedieningsbord met drukknoppen, alsook het openen en het sluiten van de machineklem.
- Hydramechanische zaagbladspanning afleesbaar over een manometer
- Bandzaag **met een hoogte van 34 mm**: hoe hoger de bandzaag, hoe langer deze het contact behoudt met het te zagen materiaal en hoe rechter de bekomen zaagsnede.
- Uitgerust **met een inverter**, waardoor het mogelijk wordt traploos snelheden te kiezen tussen 20 en 90 m/min. Hierdoor kunnen verschillende materiaalsoorten worden gezaagd, zoals roestvrij staal.
- Zware 4 kW motor biedt u genoeg power voor het zwaardere werk met overbelastingsbeveiliging
- Oliegesmeerde transmissie.
- Beschikt eveneens over variabele drukregeling van de machineklem, hierdoor kunnen ook nog steeds dunnere materialen gezaagd worden zonder dat deze worden vervormd door de zware gietijzeren machineklem.
- Onder hoek verstelbaar tot 60°, met duidelijk afleesbare gegraveerde gradenverdeling.
- Uiterst robuuste bandzaagmachine met dikke plaatstalen onderconstructie (1.250 kg).
- Regelbaar koelvloeistofstelsel met directe koeling doorheen beide zaaggeleidingen op de bandzaag.
- Voorzien langs de aanvoerszijde van een extra ondersteuningsrol, hierdoor kan het materiaal eenvoudig worden aangevoerd.
- Overgedimensioneerde rollagers op beide zaaggeleidingen en dit langs beide zijden van de bandzaag, bovendien uitgerust met grote hardmetalen geleidingsplaatjes; zo wordt de zaag perfect geleid.
- Twee krachtige compensatieveren houden de zaagbeugel stabiel.
- De bandzaag wordt continu gereinigd door een zaagborstel.
- Twee krachtige regelbare ondersteuningsarmen maken dat de zaag recht en onder de correcte spanning blijft staan.
- Binnen in de zaagbeugel zitten twee grote loopwielen voorzien van sterke lagers.
- De hydraulische gietijzeren machineklem is voorzien van afstandsgaten, zodat men efficiënter kan werken en niet de hydraulische slag van de machineklem moet afwachten.
- Voorzien van een zaagbreuk beveiliging
- Aanvoerhoogte machineklem 740 mm
- Ergonomisch geplaatst bedieningspaneel met aparte noodstop, aparte start/stop knop, vergrendelbare hoofdschakelaar, koelmiddelschakelaar, potentiometer, drukknoppen voor heffen en dalen zaagbeugel
- De kap van de zaagbeugel is uitgerust met een microscharnelaar, bij openen valt de machine stil en bij openen elektrische kast valt de machine eveneens uit. Tevens zijn de zaaggeleidingen afgeschermd.
- Andere voltages: 3x220V en 3x440V op aanvraag.

Order nr.	800170710 	
Orig. nr.	BZH350X500 VARIO	
Vermogen		
Spanning	V	3x400
Vermogen motor	kW	4
Vermogen motor koelpomp	W	120
Vermogen hydraulische motor	W	370
Afmetingen		
Zaagsnelheid	m/min	25-90
Afmetingen zaaglint (l x h x d)	mm	4350x34x1,10
Ophieven-dalen zaagbeugel		Hydraulisch
Openen-sluiten spanklem		Hydraulisch
Gewicht	kg	1250,00
Afmetingen (l x b x h)	mm	1400 x 2200 x 1800
Prijs	€	10.490,00

BZH350X500 VARIO

VARIO **ZAAGBLADEN**
p.1094

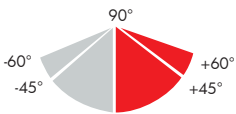

BZH350X500 VARIO ZAAGCAPACITEIT

0°		∅ 350 mm		350 mm		230 x 550 mm
45°		∅ 350 mm		320 mm		250 x 340 mm
90°		∅ 250 mm		220 mm		180 x 240 mm

Standaard geleverd met :

- Sokkel,
- Koelpomp
- Bi-metalen zaagblad
- Materiaalaanslag 500 mm met mm schaalverdeling.
- Rollenbaan van 1.400 mm
- Nederlandstalige handleiding, opschriften, CE - kenmerk, en CE-attest volgens Machine richtlijn 2006/42/CE, Laagspanningsrichtlijn 2006/95/CE en EMC Richtlijn 2004/108/CE



BZH540X950. Zware industriële dubbele kolom halfautomatische metaal bandzaagmachine voor de veileisende industrie. Met tal van standaard accessoires.

- Uiterst robuuste metaal bandzaagmachine (3.500 kg)
- **Dubbele kolom** uitvoering uitgerust met lineaire geleidingen om een precisie positionering van de zaagbeugel te garanderen.
- Alsook lineaire geleidingen van de beweegbare zaaggeleiding als de machineklem
- **Halfautomatische bandzaagmachine**, hydraulisch gestuurde functies: zakken en stijgen van de zaagbeugel zijn eenvoudig bedienbaar vanaf de PLC op het bedieningsbord met tastfuncties, alsook het openen en het sluiten van de machineklem.
- Het bedieningspaneel is digitaal en de meeste bewerkingen kunnen worden uitgevoerd via de bediening: zaagbladspanning, machineklem openen en sluiten, etc. Bovendien waarschuwt de display de bediener voor mogelijke fouten (hydraulisch / electrisch). Bovendien kan de bediener de hoekinstelling aflezen op het scherm, enkel de hydraulische daalvoeding, als de daaldruk dienen via draaiknoppen te worden geregeld.
- **Onder hoek verstelbaar van -45° tot +60°** met duidelijke afleesbare proportionele gegraveerde gradenboogverdeling, voorzien van een hydraulische klemming om de zaagbeugel in zijn positie te houden. Als optie kan geopteerd worden voor een gemotoriseerde hoekverstelling met digitale aflezing.
- Precisie gelagerde draaikolom om de zaagbeugel eenvoudig en vlot onder hoek te verdraaien.
- Groot gedimensioneerde loopwielen voorzien van een krachtige lagering
- Bandzaag met **een hoogte van 54 mm**.
- Overgedimensioneerde rollagers op beide zaaggeleidingen en dit langs beide zijden van de bandzaag, bovendien uitgerust met grote hardmetalen geleidingsplaatjes; zo wordt de zaag perfect geleid.
- **Krachtige motor van 5,5 kW** met een overbrenging naar helicoidale tandwielen constant gesmeerd in een oliebad, biedt u genoeg power voor het zwaardere werk met overbelastingsbeveiliging
- **Hydraulische zaagbladspanning** afleesbaar over een manometer
- Voorzien van zaagbreuk beveiliging
- **Gemotoriseerde spanentransporteur** als een zaagborstel, voor het continu reinigen van de spanen.
- Drukregeling voor het zagen van allerhande materialen, door middel van een draaiknop op het bedieningspaneel.
- Beschikt eveneens over variabele drukregeling van de machineklem, hierdoor kunnen ook nog steeds dunnere materialen gezaagd worden zonder dat deze worden vervormd door de zware gietijzeren machineklem, afleesbaar over een manometer.
- **Uitgerust met een inverter**, waardoor het mogelijk wordt traploos snelheden te kiezen tussen 18 en 75 m/min.
- Als standaard voorzien van een **hydraulische bovenklemming** voor het zagen van bundels.
- Halogeen machineverlichting
- **Laser zaaglijn** om een precisie zaagsnede te garanderen
- Twee koelsystemen mogelijk: regelbaar koelvloeistofsysteem met directe koeling doorheen beide zaaggeleidingen; als optie kan ook voor een olieverniveausysteem gekozen worden.
- De kap van de zaagbeugel is uitgerust met een microscharnelaar, bij openen valt de machine stil en bij openen elektrische kast valt de machine eveneens uit. Tevens zijn de zaaggeleidingen afgeschermd.
- Werkhoogte 875 mm
- Andere voltages: 3x220V en 3x440V op aanvraag.

Order nr.	800170805
Orig. nr.	BZH540X950
Vermogen	
Spanning	V 3x400
Vermogen motor	kW 5,5
Vermogen motor koelpomp	W 180
Vermogen hydraulische motor	W 1500
Afmetingen	
Zaagsnelheid	m/min 25-90
Afmetingen zaaglint (l x h x d)	mm 6900x54x1,6
Opheffen-dalen zaagbeugel	Hydraulisch
Openen-sluiten spanklem	Hydraulisch
Werkhoogte	mm 875
Gewicht	kg 3500,00
Afmetingen (l x b x h)	mm 1800 x 3700 x 2200
Prijs	€ 31.900,00

BZH540X950

NEW 5,5KW 3500kg VARIO DUBBEL VERSTEK

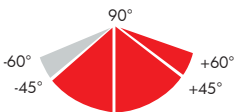
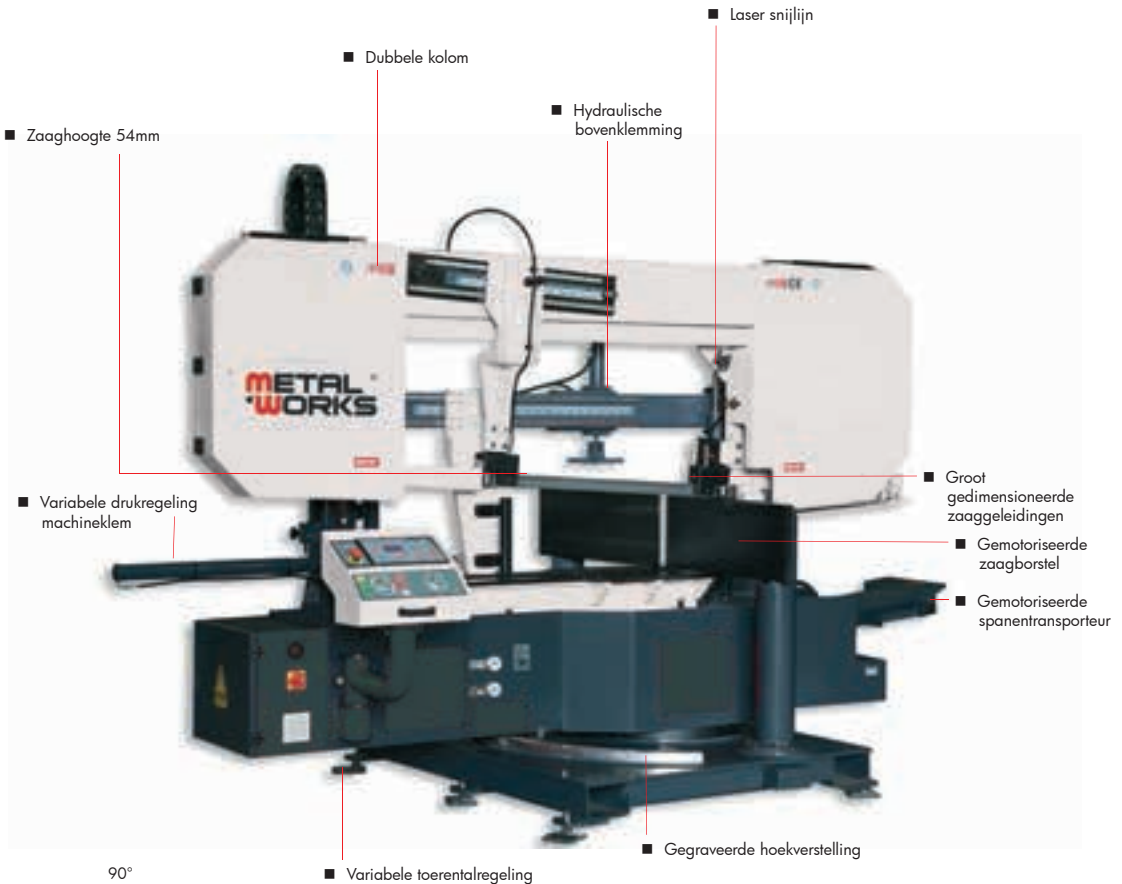

ZAAGCAPACITEIT						
0°		340 mm		340 mm		340x950 mm
30°		340 mm		340 mm		340x750 mm
45°		300 mm		300 mm		300x670 mm
60°		410 mm		410 mm		300x410 mm
30°		340 mm		340 mm		340x750 mm
45°		300 mm		300 mm		300x670 mm

Standaard geleverd met :

- Variabele toerentalregeling
- Variabele drukregeling van de machineklem als de zaagbeugel
- Koelsysteem
- Gemotoriseerde spantransporteur
- Gemotoriseerde zaagborstel
- Hydraulische zaagbladspanning
- Hydraulische bovenklemming
- Bi-metalen zaagblad
- Aanvoer rollenbaan
- Nederlandstalige handleiding, opschriften, CE - kenmerk, en CE-attest volgens Machine richtlijn 2006/42/CE, Laagspanningsrichtlijn 2006/95/CE en EMC Richtlijn 2004/108/CE



Compleet uitgeruste, budgetvriendelijke halfautomatische lintzaagmachine met grote zaagcapaciteiten, dubbel verstek en variabele zaagsnelheden.

- Deze BZH450x620 Vario werd ontworpen en gebouwd voor het zagen van bouwstalen profielen in moeilijke omstandigheden.
- Halfautomatische bandzaagmachine, hydraulisch gestuurde functies: zakken en stijgen van de zaagbeugel zijn eenvoudig bedienbaar vanaf het bedieningsbord met drukknoppen, alsook het openen en het sluiten van de machineklem
- Met **variabele zaagsnelheden van 20 tot 100 m-1**, ideaal om verschillende materiaalsoorten te zagen.
- Zagen onder verstek mogelijk dankzij het in het verstek plaatsen van de zaagbeugel **van -60° tot +60°**
- Zaagblad hoogte van 34 mm
- Robuust machineonderstel garandeert stabiliteit (1.090 kg).
- Zware 3 kW motor biedt u genoeg power voor het zwaardere werk met overbelastingsbeveiliging.
- Twee krachtige regelbare ondersteuningsarmen maken dat de zaag recht en onder de correcte spanning blijft staan.
- Binnen in de zaagbeugel zitten twee grote loopwielen voorzien van sterke lagers.
- Overgedimensioneerde rollagers op beide zaaggeleidingen en dit langs beide zijden van de bandzaag, bovendien uitgerust met grote hardmetalen geleidingsplaatjes; zo wordt de zaag perfect geleid.
- De bandzaag wordt continu gereinigd door een zaagborstel.
- Ergonomisch geplaatst bedieningspaneel met aparte noodstop en aparte start / stopknop, potentiometer.
- Voorzien van zaagbreuk beveiliging.
- Manueel zaagbladspanning.
- De kap van de zaagbeugel is uitgerust met een microscharnelaar, bij openen valt de machine stil en bij openen elektrische kast valt de machine eveneens uit. Tevens zijn de zaaggeleidingen afgeschermd
- De zaaghoek instelling is digitaal afleesbaar via het bedieningsbord, alsook zijn deze nog manueel afleesbaar.
- **Laserlijn** voor snelregeling
- Regelbaar koelvlweistofstelsysteem met directe koeling doorheen beide zaaggeleidingen op de bandzaag.
- Andere voltages: 3x220V en 3x440V op aanvraag.

Order nr.	800170715	
Orig. nr.	BZH450X620 VARIO	
Vermogen		
Vermogen motor	kW	3
Zaagsnelheid	m/min	20-100
Afmetingen		
Afmetingen zaaglint (l x h x d)	mm	5200x34x1,1
Gewicht	kg	1100,00
Afmetingen (l x b x h)	mm	2350 x 1100 x 1650
Prijs	€	11.900,00

NEW VARIO DUBBEL VERSTEK ZAAGBLADEN
p.1094

Overzichtelijke elektrische kast



■ Frequentieomvormer voor snelheid

■ Digitale weergave snijhoek

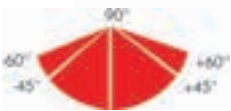

■ Manuele zaagbladspanning

■ Zaagbreuk beveiliging

■ Laserlijn voor snelregeling



■ Hardmetalen plaatjes



■ Borstel voor zaagbladreiniging

■ Regeling klemkracht

■ Elektrische koelmiddelinrichting

Delta variabele toerentalregeling

ZAAGCAPACITEIT			
0°		ø 450 mm	820x440 mm
45°		ø 450 mm	400x400 mm
60°		ø 400 mm	300x200 mm
-45°		ø 450 mm	400x400 mm
-60°		ø 350 mm	280x280 mm

Standaard geleverd met :

- Digitale weergave hoekverstelling
- Laserlijn
- Variabele toerentalregeling
- Koelpomp
- Bi-metalen zaagblad
- Nederlandstalige handleiding, opschriften, CE - kenmerk, en CE-attest volgens Machine richtlijn 2006/42/CE, Laagspanningsrichtlijn 2006/95/CE en EMC Richtlijn 2004/108/CE



BZH700x1050. Zware industriële dubbele kolom halfautomatische metaal bandzaagmachine voor de veileisende industrie. Met tal van standaard accessoires.

- Uiterst robuuste metaal bandzaagmachine (5.500 kg)
- **Dubbele kolom uitvoering** uitgerust met lineaire geleidingen om een precisie positionering van de zaagbeugel te garanderen.
- **Halfautomatische bandzaagmachine**, hydraulisch gestuurde functies: zakken en stijgen van de zaagbeugel zijn eenvoudig bedienbaar vanaf de PLC op het bedieningsbord met tastfuncties, alsook het openen en het sluiten van de machineklem.
- Het bedieningspaneel is digitaal en de meeste bewerkingen kunnen worden uitgevoerd via de bediening: zaagbladspanning, machineklem openen en sluiten, etc. Bovendien waarschuwt de display de bediener voor mogelijke fouten (hydraulisch / electrisch). Bovendien kan de bediener de hoekinstelling aflezen op het scherm, enkel de hydraulische daalvoeding, als de daaldruk dienen via draaiknoppen te worden geregeld.
- **Onder hoek verstelbaar van -45° tot +60°** met duidelijke afleesbare proportionele gegraveerde gradenboogverdeling, voorzien van een hydraulische klemming om de zaagbeugel in zijn positie te houden. Als optie kan geopteerd worden voor een gemotoriseerde hoekverstelling met digitale aflezing.
- Precisie gelagerde draaikolom om de zaagbeugel eenvoudig en vlot onder hoek te verdraaien.
- Groot gedimensioneerde loopwielen voorzien van een krachtige lagering
- Bandzaag met een hoogte van 54 mm.
- Overgedimensioneerde rollagers op beide zaaggeleidingen en dit langs beide zijden van de bandzaag, bovendien uitgerust met grote hardmetalen geleidingsplaatjes; zo wordt de zaag perfect geleid.
- **Krachtige motor van 7,5 kW** met een overbrenging naar helicoidale tandwielen constant gesmeerd in een oliebad, biedt u genoeg power voor het zwaardere werk met overbelastingsbeveiliging
- **Hydraulische zaagbladspanning** afleesbaar over een manometer
- Voorzien van zaagbreuk beveiliging
- **Gemotoriseerde spantransporteur** als een zaagborstel, voor het continu reinigen van de spanen.
- Drukregeling voor het zagen van allerhande materialen, door middel van een draaiknop op het bedieningspaneel.
- Beschikt eveneens over variabele drukregeling van de machineklem, hierdoor kunnen ook nog steeds dunnere materialen gezaagd worden zonder dat deze worden vervormd door de zware gietijzeren machineklem, afleesbaar over een manometer.
- **Uitgerust met een inverter**, waardoor het mogelijk wordt traploos snelheden te kiezen tussen 18 en 75 m/min.
- Als standaard voorzien van een hydraulische bovenklemming voor het zagen van bundels.
- Halogeen machineverlichting
- **Laser zaaglijn** om een precisie zaagsnede te garanderen
- Twee koelsystemen mogelijk: regelbaar koelvloeistofsysteem met directe koeling doorheen beide zaaggeleidingen; als optie kan ook voor een olieverniveausysteem gekozen worden.
- De kap van de zaagbeugel is uitgerust met een microscharnelaar, bij openen valt de machine stil en bij openen elektrische kast valt de machine eveneens uit. Tevens zijn de zaaggeleidingen afgeschermd.
- Werkhoogte 870 mm
- Andere voltages: 3x220V en 3x440V op aanvraag.

Order nr.		800170810 M
Orig. nr.		BZH700X1050
Vermogen		
Spanning	V	3x400
Vermogen motor	kW	7,5
Vermogen motor koelpomp	W	180
Vermogen hydraulische motor	W	1500
Afmetingen		
Zaagsnelheid	m/min	18-75
Afmetingen zaaglint (l x h x d)	mm	8200x54x1,6
Opheffen-dalen zaagbeugel		Hydraulisch
Openen-sluiten spanklem		Hydraulisch
Werkhoogte	mm	870
Gewicht	kg	5500,00
Afmetingen (l x b x h)	mm	1800 x 2800 x 4400
Prijs	€	35.900,00

NEW 7,5KW VARIO DUBBEL VERSTEK

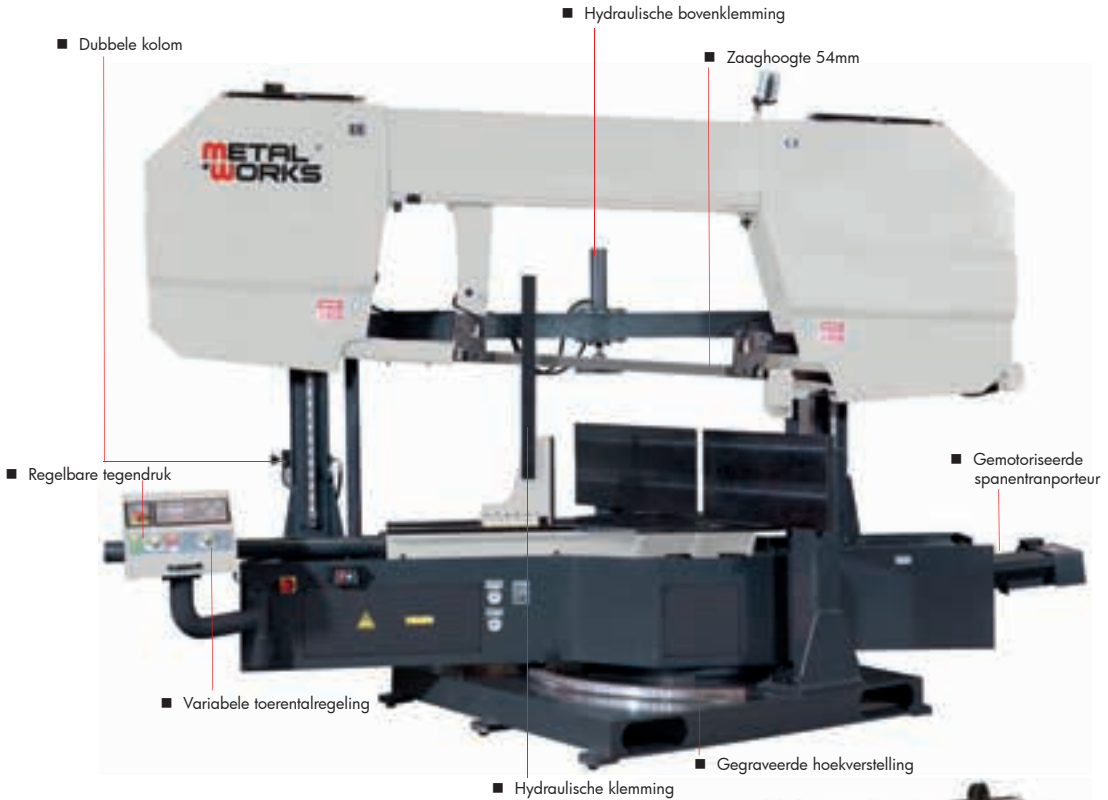

Zaagcapaciteit					
45°	700 mm	650 mm	600 mm	550 mm	500 mm
30°	700 mm	650 mm	600 mm	550 mm	500 mm
45°	700 mm	650 mm	600 mm	550 mm	500 mm
60°	400 mm	400 mm	400 mm	400 mm	400 mm
30°	700 mm	650 mm	600 mm	550 mm	500 mm
45°	700 mm	650 mm	600 mm	550 mm	500 mm

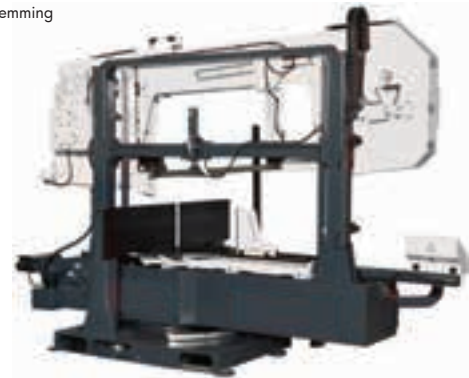

Standaard geleverd met :

- Variabele toerentalregeling
- Variabele drukregeling van de machineklem als de zaagbeugel
- Koelsystemen
- Gemotoriseerde spantransporteur
- Gemotoriseerde zaagborstel
- Hydraulische zaagbladspanning
- Hydraulische bovenklemming
- Bi-metalen zaagblad
- Aanvoer rollenbaan

- Nederlandstalige handleiding, opschriften, CE - kenmerk, en CE-attest volgens Machine richtlijn 2006/42/CE, Laagspanningsrichtlijn 2006/95/CE en EMC Richtlijn 2004/108/CE



BZA280X300. Zware industriële automatische metaal bandzaagmachine, scharniermodel voor de veileisende industrie. Met tal van standaard accessoires.

- Robuuste metaal bandzaagmachine (1.175 kg)
- **Automatische bandzaagmachine**, hydraulisch gestuurde functies: zakken en stijgen van de zaagbeugel zijn eenvoudig bedienbaar vanaf de PLC op het bedieningsbord, alsook het openen en het sluiten van de machineklem, als het aanvoeren van materiaal via de beweegbare machineklem.
- **PLC bedieningspaneel met touchscreen**, waarop cyclus start, koeling, snelheid, openen/sluiten van de klemmen, dalen/stijgen van de zaagbeugel, als de aanvoer kunnen geregeld worden. Manuele of automatische modus, ingave van de te zagen lengte, het aantal te zagen te stukken, als de cyclustijd.
- Groot gedimensioneerde loopwielen voorzien van een krachtige lagering
- **Bandzaag met een hoogte van 27 mm**.
- Overgedimensioneerde rollagers op beide zaaggeleidingen en dit langs beide zijden van de bandzaag, bovendien uitgerust met grote hardmetalen geleidingsplaatjes; zo wordt de zaag perfect geleid.
- Krachtige motor van 2,2 kW met een overbrenging naar helicoïdale tandwielen constant gesmeerd in een oliebad, biedt u genoeg power voor het zwaardere werk met overbelastingsbeveiliging
- **Hydromechanische zaagbladspanning** afleesbaar over een manometer
- Voorzien van zaagbreuk beveiliging
- Drukregeling voor het zagen van allerhande materialen, door middel van een draaiknop op het bedieningspaneel.
- Beschikt eveneens over variabele drukregeling van de machineklem, hierdoor kunnen ook nog steeds dunnere materialen gezaagd worden zonder dat deze worden vervormd door de zware gietijzeren machineklem, afleesbaar over een manometer.
- Servo aanvoer, via een verplaatsbare machineklem..
- **Uitgerust met een inverter**, waardoor het mogelijk wordt traploos snelheden te kiezen tussen 25 en 100 m/min.
- Als standaard voorzien van **een hydraulische bovenklemming** voor het zagen van bundels.
- **Laser zaaglijn** om een precisie zaagsnede te garanderen
- Regelbaar koelvloeistofsysteem mogelijk: met directe koeling doorheen beide zaaggeleidingen; als optie kan ook voor een olieverniveausysteem gekozen worden.
- De kap van de zaagbeugel is uitgerust met een microscharnelaar, bij openen valt de machine stil en bij openen elektrische kast valt de machine eveneens uit. Tevens zijn de zaaggeleidingen afgeschermd.
- Werkhoogte 715 mm
- Andere voltages: 3x220V en 3x440V op aanvraag.

Order nr.		800170720
Orig. nr.		BZA280X300
Vermogen		
Spanning	V	3x400
Vermogen motor	kW	2,2
Vermogen motor koelpomp	W	120
Vermogen hydraulische motor	W	1100
Afmetingen		
Zaagsnelheid	m/min	25-100
Afmetingen zaaglint (l x h x d)	mm	3660x27x0,9
Opheffen-dalen zaagbeugel		hydraulisch
Openen-sluiten spanklem		hydraulisch
Werkhoogte	mm	715
Gewicht	kg	1175,00
Afmetingen (l x b x h)	mm	1600 x 1850 x 1250
Prijs	€	15.390,00

NEW 2,2KW 1175kg VARIO PLC ZAAGBLADEN
p.1094



ZAAGCAPACITEIT						
0°		280 mm		280 mm		280x300 mm

Standaard geleverd met :

- Variabele toerentalregeling
- Variabele drukregeling van de machineklem als de zaagbeugel
- Gemotoriseerde zaagborstel
- Hydraulische bovenklemming
- Bi-metalen zaagblad
- Aanvoer rollenbaan
- Nederlandstalige handleiding, opschriften, CE - kenmerk, en CE-attest volgens Machine richtlijn 2006/42/CE, Laagspanningsrichtlijn 2006/95/CE en EMC Richtlijn 2004/108/CE



BZA340X430. Zware industriële automatische metaal bandzaagmachine, scharniermodel voor de veileisende industrie. Met tal van standaard accessoires.

- Robuuste metaal bandzaagmachine (1.800 kg)
- **Automatische** bandzaagmachine, hydraulisch gestuurde functies: zakken en stijgen van de zaagbeugel zijn eenvoudig bedienbaar vanaf de PLC op het bedieningsbord, alsook het openen en het sluiten van de machineklem, als het aanvoeren van materiaal via de beweegbare machineklem.
- PLC bedieningspaneel met touchscreen, waarop cyclus start, koeling, snelheid, openen/sluiten van de klemmen, dalen/stijgen van de zaagbeugel, als de aanvoer kunnen geregeld worden. Manuele of automatische modus, ingave van de te zagen lengte, het aantal te zagen te stukken, als de cyclustijd.
- Groot gedimensioneerde loopwielen voorzien van een krachtige lagering
- Bandzaag met **een hoogte van 34 mm**.
- Overgedimensioneerde rollagers op beide zaaggeleidingen en dit langs beide zijden van de bandzaag, bovendien uitgerust met grote hardmetalen geleidingsplaatjes; zo wordt de zaag perfect geleid.
- Krachtige motor van 4 kW met een overbrenging naar helicoidale tandwielen constant gesmeerd in een oliebad, biedt u genoeg power voor het zwaardere werk met overbelastingsbeveiliging
- **Hydraulische zaagbladspanning** afleesbaar over een manometer
- Voorzien van zaagbreuk beveiliging
- **Gemotoriseerde spantransporteur** als een zaagborstel, voor het continu reinigen van de spanen
- Drukregeling voor het zagen van allerhande materialen, door middel van een draaiknop op het bedieningspaneel.
- Beschikt eveneens over **variabele drukregeling** van de machineklem, hierdoor kunnen ook nog steeds dünnere materialen gezaagd worden zonder dat deze worden vervormd door de zware gietijzere machineklem, afleesbaar over een manometer.
- Servo aanvoer, via een verplaatsbare machineklem..
- Uitgerust met een inverter, waardoor het mogelijk wordt traploos snelheden te kiezen tussen 25 en 100 m/min.
- Als standaard voorzien van een **hydraulische bovenklemming** voor het zagen van bundels.
- Laser zaaglijn om een precisie zaagsnede te garanderen
- Regelbaar koelvlloeistofstelsel met directe koeling doorheen beide zaaggeleidingen; als optie kan ook voor een olieverniveausysteem gekozen worden.
- De kap van de zaagbeugel is uitgerust met een microscharnelaar, bij openen valt de machine stil en bij openen elektrische kast valt de machine eveneens uit. Tevens zijn de zaaggeleidingen afgeschermd.
- Werkhoogte 700 mm
- Andere voltages: 3x220V en 3x440V op aanvraag.

Order nr.		800170730
Orig. nr.		BZA340X430
Vermogen		
Spanning	V	3x400
Vermogen motor	kW	4
Vermogen motor koelpomp	W	120
Vermogen hydraulische motor	W	1100
Afmetingen		
Zaagsnelheid	m/min	25-100
Afmetingen zaaglint (l x h x d)	mm	3910x34x1,1
Opheffen-dalen zaagbeugel		hydraulisch
Openen-sluiten spanklem		hydraulisch
Werkhoogte	mm	700
Gewicht	kg	1800,00
Afmetingen (l x b x h)	mm	2050 x 1300 x 1600
Prijs	€	19.900,00

NEW 1800kg VARIO PLC ZAAGBLADEN
p.1094



ZAAGCAPACITEIT						
Ø		340 mm		340 mm		340x430 mm

Standaard geleverd met :

- Variabele toerentalregeling
- Variabele drukregeling van de machineklem als de zaagbeugel
- Koelsysteem
- Gemotoriseerde spantransporteur
- Gemotoriseerde zaagborstel
- Hydraulische zaagbladspanning
- Hydraulische bovenklemming
- Bi-metalen zaagblad
- Aanvoer rollenbaan
- Nederlandstalige handleiding, opschriften, CE - kenmerk, en CE-attest volgens Machine richtlijn 2006/42/CE, Laagspanningsrichtlijn 2006/95/CE en EMC Richtlijn 2004/108/CE



BZA440X550. Zware industriële dubbele kolom automatische metaal bandzaagmachine voor de veileisende industrie. Met tal van standaard accessoires.

- Uiterst robuuste metaal bandzaagmachine (2.300 kg)
- **Dubbele kolom** uitvoering uitgerust met lineaire geleidingen om een precisie positionering van de zaagbeugel te garanderen.
- **Automatische** bandzaagmachine, hydraulisch gestuurde functies: zakken en stijgen van de zaagbeugel zijn eenvoudig bedienbaar vanaf de PLC op het bedieningsbord, alsook het openen en het sluiten van de machineklem, als het aanvoeren van materiaal via de beweegbare machineklem.
- PLC bedieningspaneel met touchscreen, waarop cyclus start, koeling, spanentransporteur, snelheid, openen/sluiten van de klemmen, dalen/stijgen van de zaagbeugel, als de aanvoer kunnen geregeld worden. Manuele of automatische modus, ingave van de te zagen lengte, het aantal te zagen te stukken, als de cyclustijd.
- De vaste machineklem vooraan bestaat uit twee delen, één voor het zaagblad en één na het zaagblad. Hierdoor wordt een optimale klemming van het werkstuk gegarandeerd.
- Groot gedimensioneerde loopwielen voorzien van een krachtige lagering
- Bandzaag met een hoogte van 41 mm.
- Overgedimensioneerde rollagers op beide zaaggeleidingen en dit langs beide zijden van de bandzaag, bovendien uitgerust met grote hardmetalen geleidingsplaatjes; zo wordt de zaag perfect geleid.
- Krachtige motor van 4 kW met een overbrenging naar helicoidale tandwielen constant gesmeerd in een oliebad, biedt u genoeg power voor het zwaardere werk met overbelastingsbeveiliging
- **Hydraulische zaagbladspanning** afleesbaar over een manometer
- Voorzien van zaagbreuk beveiliging
- **Gemotoriseerde spanentransporteur** als een zaagborstel, voor het continu reinigen van de spanen.
- Drukregeling voor het zagen van allerhande materialen, door middel van een draaiknop op het bedieningspaneel.
- Beschikt eveneens over variabele drukregeling van de machineklem, hierdoor kunnen ook nog steeds dünnere materialen gezaagd worden zonder dat deze worden vervormd door de zware gietijzere machineklem, afleesbaar over een manometer.
- **Servo aanvoer**, via een verplaatsbare machineklem, waarvan de bekabeling ordentelijk is weggestopt in een kabelgoot. De geleidingen van de aanvoer zijn afgeschermd tegen spanen.
- Uitgerust **met een inverter**, waardoor het mogelijk wordt traploos snelheden te kiezen tussen 25 en 100 m/min.
- Als standaard voorzien van een **hydraulische bovenklemming** voor het zagen van bundels.
- Laser zaaglijn om een precisie zaagsnede te garanderen
- Twee koelsystemen: regelbaar koelvloeijsysteem met directe koeling doorheen beide zaaggeleidingen; als optie kan ook voor een olieverniveausysteem gekozen worden.
- De kap van de zaagbeugel is uitgerust met een microscharnelaar, bij openen valt de machine stil en bij openen elektrische kast valt de machine eveneens uit. Tevens zijn de zaaggeleidingen afgeschermd.
- Werkhoogte 705 mm
- Andere voltages: 3x220V en 3x440V op aanvraag.

Order nr.		800170815 M
Orig. nr.		BZA440X550
Vermogen		
Spanning	V	3x400
Vermogen motor	kW	4
Vermogen motor koelpomp	W	180
Vermogen hydraulische motor	W	1500
Afmetingen		
Zaagsnelheid	m/min	25-100
Afmetingen zaaglint (l x h x d)	mm	5100x41x1,3
Ophffen-dalen zaagbeugel		hydraulisch
Openen-sluiten spanklem		hydraulisch
Werkhoogte	mm	705
Gewicht	kg	2300,00
Afmetingen (l x b x h)	mm	2055 x 2570 x 1950
Prijs	€	36.990,00

NEW 4KW VARIO PLC ZAAGBLADEN
p.1094

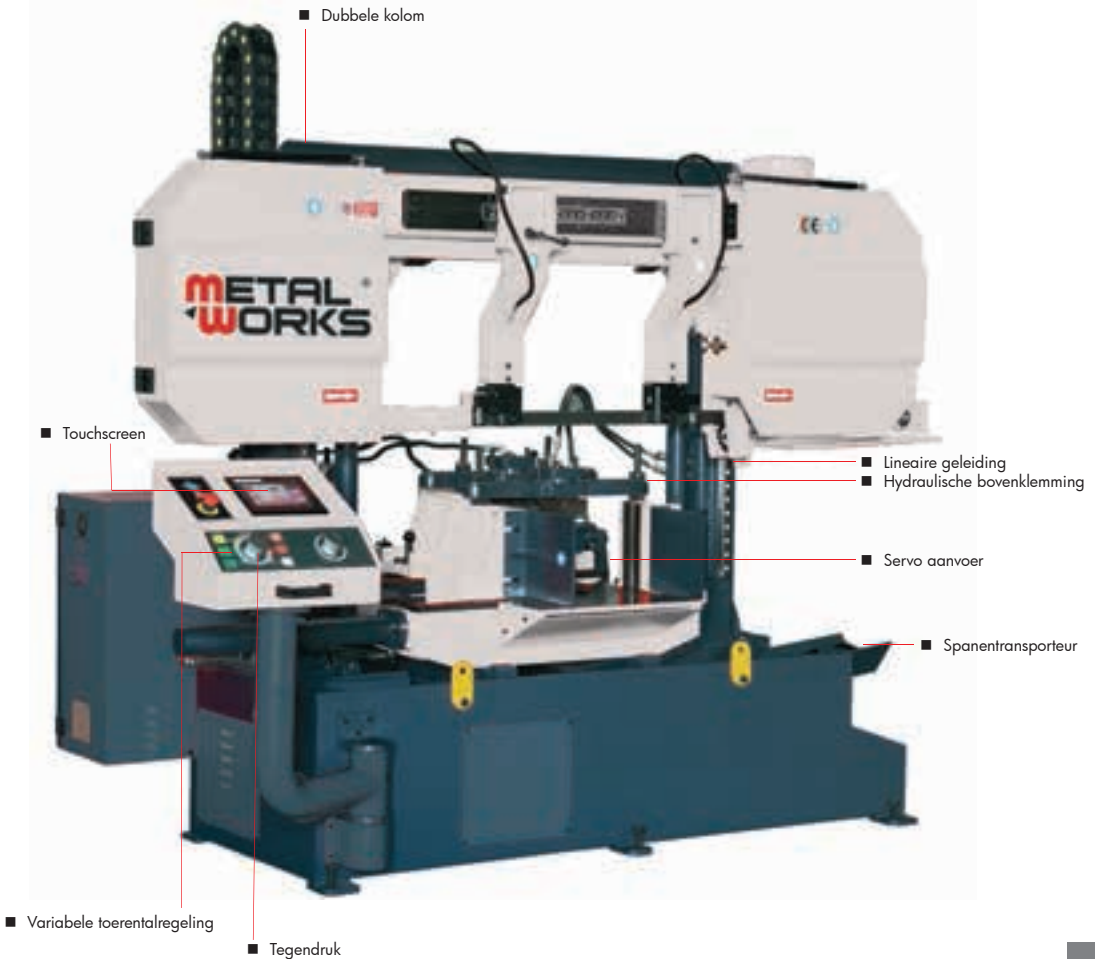

ZAAGCAPACITEIT				
0°		440 mm		440 mm
		440x550 mm		

Standaard geleverd met :

- Variabele toerentalregeling
- Variabele drukregeling van de machineklem als de zaagbeugel
- Twee koelsystemen
- Gemotoriseerde spantransporteur
- Gemotoriseerde zaagborstel
- Hydraulische zaagbladspanning
- Hydraulische bovenklemming
- Bi-metalen zaagblad
- Aanvoer rollenbaan

- Nederlandstalige handleiding, opschriften, CE - kenmerk, en CE-attest volgens Machine richtlijn 2006/42/CE, Laagspanningsrichtlijn 2006/95/CE en EMC Richtlijn 2004/108/CE



BZA540X700. Zware industriële dubbele kolom automatische metaal bandzaagmachine voor de veileisende industrie. Met tal van standaard accessoires.

- Uiterst robuuste metaal bandzaagmachine (3.800 kg)
- **Dubbele kolom uitvoering** uitgerust met lineaire geleidingen om een precisie positionering van de zaagbeugel te garanderen.
- **Automatische bandzaagmachine**, hydraulisch gestuurde functies: zakken en stijgen van de zaagbeugel zijn eenvoudig bedienbaar vanaf de PLC op het bedieningsbord, alsook het openen en het sluiten van de machineklem, als het aanvoeren van materiaal via de beweegbare machineklem.
- **PLC bedieningspaneel met touchscreen**, waarop cyclus start, koeling, spanentransporteur, snelheid, openen/sluiten van de klemmen, dalen/stijgen van de zaagbeugel, als de aanvoer kunnen geregeld worden. Manuele of automatische modus, ingave van de te zagen lengte, het aantal te zagen te stukken, als de cyclustijd.
- De vaste machineklem vooraan bestaat uit twee delen, één voor het zaagblad en één na het zaagblad. Hierdoor wordt een optimale klemming van het werkstuk gegarandeerd.
- Groot gedimensioneerde loopwielen voorzien van een krachtige lagering
- **Bandzaag met een hoogte van 54 mm.**
- Overgedimensioneerde rollagers op beide zaaggeleidingen en dit langs beide zijden van de bandzaag, bovendien uitgerust met grote hardmetalen geleidingsplaatjes; zo wordt de zaag perfect geleid.
- Krachtige motor van 5,5 kW met een overbrenging naar helicoidale tandwielen constant gesmeerd in een oliebad, biedt u genoeg power voor het zwaardere werk met overbelastingsbeveiliging
- **Hydraulische zaagbladspanning** afleesbaar over een manometer
- Voorzien van zaagbreuk beveiliging
- **Gemotoriseerde spanentransporteur** als een zaagborstel, voor het continu reinigen van de spanen.
- Drukregeling voor het zagen van allerhande materialen, door middel van een draaiknop op het bedieningspaneel.
- Beschikt eveneens over variabele drukregeling van de machineklem, hierdoor kunnen ook nog steeds dunnere materialen gezaagd worden zonder dat deze worden vervormd door de zware gietijzeren machineklem, afleesbaar over een manometer.
- Servo aanvoer, via een verplaatsbare machineklem, waarvan de bekabeling ordentelijk is weggestopt in een kabelgoot. De geleidingen van de aanvoer zijn afgeschermd tegen spanen.
- **Uitgerust met een inverter**, waardoor het mogelijk wordt traploos snelheden te kiezen tussen 18 en 75 m/min.
- Als standaard voorzien van een **hydraulische bovenklemming** voor het zagen van bundels.
- **Laser zaaglijn** om een precisie zaagsnede te garanderen
- Twee koelsystemen mogelijk: regelbaar koelvloeistofsysteem met directe koeling doorheen beide zaaggeleidingen; als optie kan ook voor een olieverniveausysteem gekozen worden.
- De kap van de zaagbeugel is uitgerust met een microscharnelaar, bij openen valt de machine stil en bij openen elektrische kast valt de machine eveneens uit. Tevens zijn de zaaggeleidingen afgeschermd.
- Werkhoogte 730 mm
- Andere voltages: 3x220V en 3x440V op aanvraag.

Order nr.		800170820
Orig. nr.		BZA540X700
Vermogen		
Spanning	V	3x400
Vermogen motor	kW	5,5
Vermogen motor koelpomp	W	250
Vermogen hydraulische motor	W	1500
Afmetingen		
Zaagsnelheid	m/min	18-75
Afmetingen zaaglint (l x h x d)	mm	6540x54x1,3
Opheffen-dalen zaagbeugel		hydraulisch
Openen-sluiten spanklem		hydraulisch
Werkhoogte	mm	730
Gewicht	kg	3800,00
Afmetingen (l x b x h)	mm	2255 x 3185 x 2140
Prijs	€	40.900,00

3800kg VARIO PLC

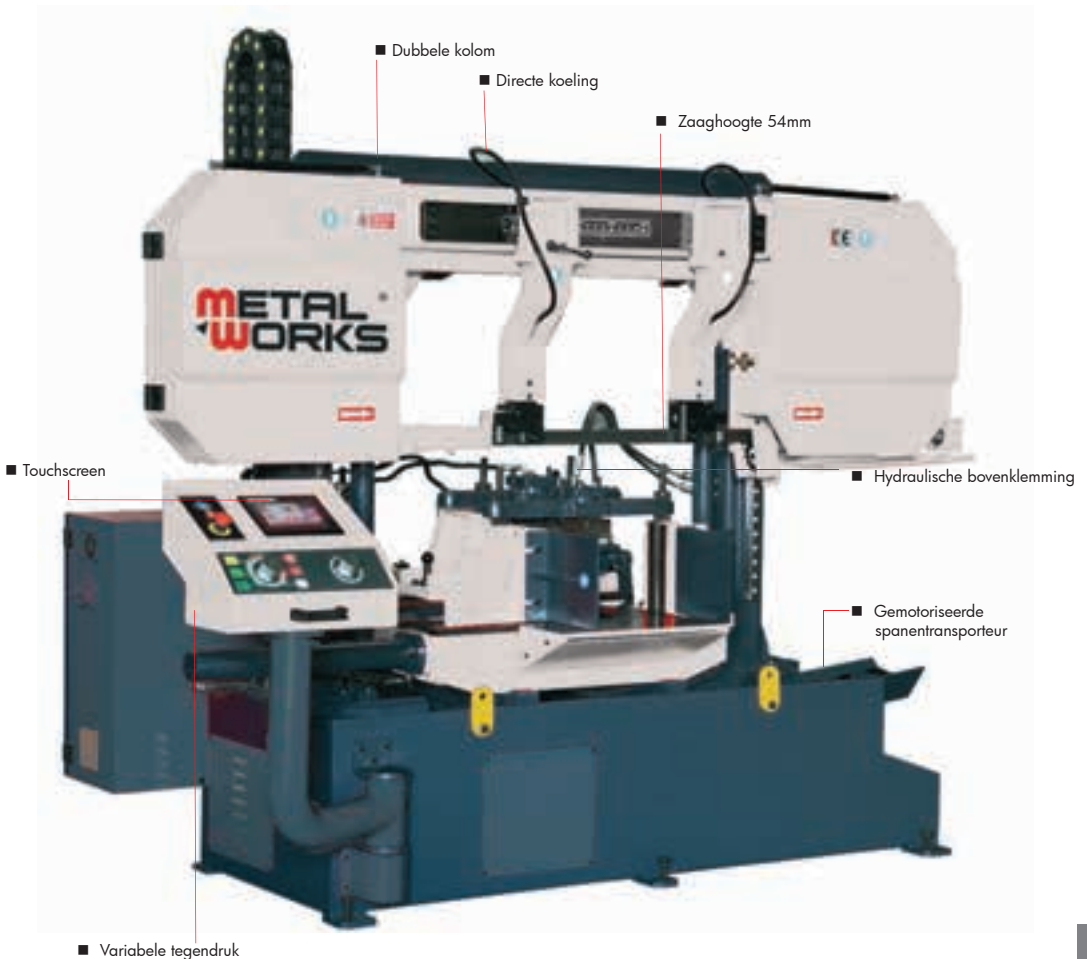

ZAAGCAPACITEIT						
0°		540 mm		540 mm		540x700 mm

Standaard geleverd met :

- Variabele toerentalregeling
- Variabele drukregeling van de machineklem als de zaagbeugel
- Koelsystemen
- Gemotoriseerde spantransporteur
- Gemotoriseerde zaagborstel
- Hydraulische zaagbladspanning
- Hydraulische bovenklemming
- Bi-metalen zaagblad
- Aanvoer rollenbaan
- Nederlandstalige handleiding, opschriften, CE - kenmerk, en CE-attest volgens Machine richtlijn 2006/42/CE, laagspanningsrichtlijn 2006/95/CE en EMC Richtlijn 2004/108/CE

Materialsteunen

holzstar



Samenplooibare materiaalsteun met rol. Traploos in hoogte verstelbaar.

Order nr.	715900005
Orig. nr.	MS3R
Minimum/maximum hoogte legvlak	mm 670-1150
Capaciteit	kg 30
Maximum breedte	mm 285
Gewicht	kg 4,00
Afmetingen (l x b x h)	mm 430 x 500 x 1150
Prijs	€ 24,00

holzstar



Materiaalsteun met rol. Stabiele constructie. Traploos in hoogte verstelbaar. Eenvoudig te transporteren. Samenplooibaar.

Order nr.	715900003
Orig. nr.	MS1R
Minimum/maximum hoogte legvlak	mm 700-1150
Capaciteit	kg 30
Maximum breedte	mm 390
Gewicht	kg 10,00
Afmetingen (l x b x h)	mm 135 x 500 x 810
Prijs	€ 55,00

metallkraft



Zware gietijzeren materiaalsteun voor metaal -en houtbewerking. Voor gebruik in zware omstandigheden. Capaciteit 700kg. Massieve stalen rollen en stabiele gietijzeren voet. Geschikt voor ronde buizen. Traploos instelbare hoogte.

Order nr.	713660705
Orig. nr.	MS3V
Capaciteit	kg 700
Hoogte minimum/maximum	mm 580/790
Breedte maximum	mm 2x125
Diameter rollen	mm 52
Gewicht	kg 16,00
Prijs	€ 99,00

metallkraft



Zware gietijzeren materiaalsteun voor metaal -en houtbewerking. Voor gebruik in zware omstandigheden. Capaciteit 700kg.

Massieve stalen rollen en stabiele gietijzeren voet.

Traploos instelbare hoogte.

Order nr.	713660700
Orig. nr.	MS3
Capaciteit	kg 700
Hoogte minimum/maximum	mm 580/790
Breedte maximum	mm 350
Diameter rollen	mm 52
Gewicht	kg 16,00
Prijs	€ 60,00

holzstar



Materiaalsteun met kogellagers. Traploos in hoogte verstelbaar. Eenvoudig te transporteren. Samenklapbaar.

Order nr.	715900004
Orig. nr.	MS1K
Minimum/maximum hoogte legvlak	mm 700-1150
Capaciteit	kg 30
Maximum breedte	mm 390
Gewicht	kg 12,00
Afmetingen (l x b x h)	mm 135 x 500 x 810
Prijs	€ 52,00

Rollenbanen

holzstar



Opvouwrollenbaan met hoogte en lengteverstelling
 - Zeer robuute poten uit stalen kokers
 - Volverzinkte rollen
 - 360° draaibare kunststof wielen met rem
 - Hoogteverstelling 60-100cm: elke poot apart instelbaar
 - Lengteverstelling 50-140 cm: accordeonsysteem
 - Gemakkelijk koppelen van meerdere rollenbanen met haaksysteem

Order nr.	715900012 M
Orig. nr.	SRB130
Minimum/maximum hoogte legvlak mm	670-970
Capaciteit	130
Gewicht	36,00
Afmetingen (l x b x h)	1480 x 670 x 970
Prijs	€ 235,00

OPTIMUM



In de hoogte verstelbare rollenbaan. Manuele aanvoerhulp voor zaagmachines. Ideaal voor de aanvoer van lange en zware werkstukken. Zowel voor bandzaag- als cirkelzaagmachines. In de hoogte verstelbare voeten waardoor universeel toepasbaar voor diverse type zaagmachines. Massieve en robuuste stalen rollen. Montage mogelijk van het LMS-lengtemeetsysteem (zie hierna). Geleverd met bevestigingsbeugels voor het aan elkaar monteren van verschillende rollenbanen.

Kader:

-stabiele uitvoering, -sterke speciale profielen, -draagrollen, afzonderlijk verkrijgbaar 790024000, -staal, -lang beide zijden gelagerd

Opleghoogte:

-in de hoogte verstelbaar 650 - 950 mm

Optioneel:

-bijkomend te monteren, -uit roestvrij PVC, -om krassen te vermijden, -rollen zijn eenvoudig de voorziene ophanging te monteren, -bestellen onder 713357609

Order nr.	713357610 M	713357611 M	713357613 M
Orig. nr.	MSR4	MSR7	MSR10
Diameter rollen mm	60	60	60
Lengte rollen mm	360	360	360
Lengte rollenbaan mm	1000	2000	3000
Breedte rollenbaan mm	440	440	440
Hoogte rollenbaan mm	650-950	650-950	650-950
Statische draagkracht kg	500	700	700
Gewicht kg	30,00	58,00	79,00
Afmetingen (l x b x h) mm	1080x470x170	2100x470x180	3100x470x180
Prijs	€ 159,00	299,00	659,00

OPTIMUM



PVC rollers voor MSR4-MSR7. Eenvoudig te monteren optionele rollenset met slijtvaste zachte PVC coating. Deze rollen zijn uiterst geschikt voor het aanvoeren van zachte en gelakte materialen. Door de zachte PVC coating wordt het oppervlak van de profielen niet beschadigd tijdens het aanvoeren. Set van drie rollen, eenvoudig te monteren op de bijgeleverd beugels .

Order nr.	713357609 M
Orig. nr.	3357609
Gewicht	kg 7,00
Afmetingen (l x b x h)	mm 410 x 230 x 240
Prijs	€ 117,00

OPTIMUM



Losse rol voor rollenbaan MSR4-MSR7-MSR10. Compleet met draadstang en rollagers.

Order nr.	790024000 M
Orig. nr.	LR360
Rollengte mm	360
Diameter mm	59
Complete rol met draadstang lengte mm	400
Draad	M12
Asdiameter mm	17
Lagers	6003Z
Gewicht kg	2,50
Prijs	€ 31,90



type A



type A



type B



type C



type EP

Stabiele rollenbanen en meetsystemen met draagkracht van 300 kg per meter. U-vormige constructie uit 3mm-staalprofielen. Verzinkte kogelgelagerde draagrollen.

Karakteristieken:

- roldiameter: 60 mm,
- asdiameter: 15 mm
- bruikbare rolbreedte: 250 of 350 mm (zie tabel)
- draagkracht: 300 kg/m
- werkhogte: 880 mm +- 60 mm (voeten verstelbaar).

Leverbaar in 4 verschillende types, elk met hun specifieke toepassing:

- type A: Rollenbaan met meetsysteem met LED-aanduiding, op 230V. Manuele verstelbare aanslag (via handwiel), stabiele wagen is omhoogklapbaar.
- type B: Rollenbaan met manueel meetsysteem op U-profiel, en omhoogklapbare aanslag
- type C: Rollenbaan zonder meetsysteem of aanslag. Geschikt als aan- of afvoerbaan.
- type EP: Rollenbaan met digitaal meetsysteem (op magneetband) met LCD-afleesscherm.

Maximale meetlengte is de rollenbaanlengte min de aanslaglengte:

- MRB A 450mm
- MRB B 150mm
- MRB EP 260mm

Optioneel:

- kunststofrollen en montage-adapter voor MKS-machines.
- geveerde aanslag en pneumatisch terugkerende aanslag op A-modellen.

Order nr.	Orig. nr.	Type	Bruikbare rolbreedte mm	Lengte m	Aantal voeten	Gewicht kg	Prijs €
713661111	M 3661111	A	250	1	2	50,00	2.179,00
713661112	M 3661112	A	250	2	2	100,00	2.879,00
713661113	M 3661113	A	250	3	3	150,00	3.190,00
713661114	M 3661114	A	250	4	3	200,00	3.590,00
713661115	M 3661115	A	250	5	4	250,00	4.149,00
713661116	M 3661116	A	250	6	5	300,00	4.995,00
713661117	M 3661117	A	250	7	5	350,00	5.600,00
713661118	M 3661118	A	250	8	6	400,00	6.250,00
713661121	M 3661121	A	350	1	2	50,00	2.189,00
713661122	M 3661122	A	350	2	2	100,00	2.970,00
713661123	M 3661123	A	350	3	3	150,00	3.119,00
713661124	M 3661124	A	350	4	3	200,00	3.905,00
713661125	M 3661125	A	350	5	4	250,00	4.565,00
713661126	M 3661126	A	350	6	5	300,00	5.340,00
713661127	M 3661127	A	350	7	5	350,00	5.960,00
713661128	M 3661128	A	350	8	6	400,00	6.640,00
713661211	M 3661211	B	250	1	2	50,00	760,00
713661212	M 3661212	B	250	2	2	100,00	1.140,00
713661213	M 3661213	B	250	3	3	150,00	1.390,00
713661214	M 3661214	B	250	4	3	200,00	1.765,00
713661215	M 3661215	B	250	5	4	250,00	2.190,00
713661216	M 3661216	B	250	6	5	300,00	2.620,00
713661217	M 3661217	B	250	7	5	350,00	2.975,00
713661218	M 3661218	B	250	8	6	400,00	3.385,00
713661221	M 3661221	B	350	1	2	50,00	780,00
713661222	M 3661222	B	350	2	2	100,00	1.255,00
713661223	M 3661223	B	350	3	3	150,00	1.625,00
713661224	M 3661224	B	350	4	3	200,00	1.925,00
713661225	M 3661225	B	350	5	4	250,00	2.410,00
713661226	M 3661226	B	350	6	5	300,00	2.910,00
713661227	M 3661227	B	350	7	5	350,00	3.285,00
713661228	M 3661228	B	350	8	6	400,00	3.765,00
713661311	M 3661311	C	250	1	2	50,00	476,00
713661312	M 3661312	C	250	2	2	100,00	805,00
713661313	M 3661313	C	250	3	3	150,00	935,00
713661314	M 3661314	C	250	4	3	200,00	1.139,00
713661315	M 3661315	C	250	5	4	250,00	1.619,00
713661316	M 3661316	C	250	6	5	300,00	1.945,00
713661317	M 3661317	C	250	7	5	350,00	2.219,00
713661318	M 3661318	C	250	8	6	400,00	2.555,00
713661321	M 3661321	C	350	1	2	50,00	519,00
713661322	M 3661322	C	350	2	2	100,00	899,00
713661323	M 3661323	C	350	3	3	150,00	1.225,00
713661324	M 3661324	C	350	4	3	200,00	1.459,00
713661325	M 3661325	C	350	5	4	250,00	1.839,00
713661326	M 3661326	C	350	6	5	300,00	2.239,00
713661327	M 3661327	C	350	7	5	350,00	2.535,00
713661328	M 3661328	C	350	8	6	400,00	2.945,00
713661512	M 3661512	EP	300	2	2	100,00	2.955,00
713661513	M 3661513	EP	300	3	3	150,00	3.550,00
713661514	M 3661514	EP	300	4	3	200,00	4.199,00
713661515	M 3661515	EP	300	5	4	250,00	4.920,00
713661516	M 3661516	EP	300	6	5	300,00	5.640,00
713661517	M 3661517	EP	300	7	5	350,00	6.300,00
713661518	M 3661518	EP	300	8	6	400,00	7.030,00
713661521	M 3661521	EP	400	1	2	50,00	2.255,00
713661522	M 3661522	EP	400	2	2	100,00	3.039,00
713661523	M 3661523	EP	400	3	3	150,00	3.760,00
713661524	M 3661524	EP	400	4	3	200,00	4.379,00
713661525	M 3661525	EP	400	5	4	250,00	5.150,00
713661526	M 3661526	EP	400	6	5	300,00	5.930,00
713661527	M 3661527	EP	400	7	5	350,00	6.630,00
713661528	M 3661528	EP	400	8	6	400,00	7.410,00









Universeel digitaal meetsysteem.

- Voor opbouw op rollenbaan MSR4, MSR7 en MSR10 voor een perfecte langsmeting en een exacte positionering.
- De afstand zaagsnit – startpunt meting kan opgeslagen worden als vast startpunt voor elke meting aan het begin van de rollenbaan.
- Magnetisch meetsysteem.
- Voor serie metingen met een hoge precisie van 0,1 mm.
- Automatisch inschakelen van afleesscherm.
- Meetsysteem schakelt automatisch uit bij langdurig niet-gebruik en behoudt de laatste meting in het geheugen.
- Meetnauwkeurigheid : +/- (0,025 +0,02 x meetlengte (m)).
- Opklapbare aanslag (vermindert de afstand van de meetafstand met 170 mm)
- Levensduur van de batterij tot 10 jaar.
- Rollenbaan niet inbegrepen.

Lineaire geleiding:

- smeervrij
- zeer licht loop
- slijtvast
- corrosiebestendig
- lage wrijvingscoëfficiënt

Order nr.	Orig. nr.	Lengte mm	Bruikbare verplaatsing mm	Gewicht kg	Afmetingen (l x b x h) mm	Prijs €
713383881 	LMS1	1000	830	7,00	1100 x 110 x 70	829,00
713383882 	LMS2	2000	1830	10,00	2100 x 110 x 70	929,00
713383883 	LMS3	3000	2830	12,00	3100 x 110 x 70	1.130,00
713383884 	LMS4	4000	3830	14,00	4100 x 110 x 70	1.195,00
713383885 	LMS5	5000	4830	16,00	5100 x 110 x 70	1.395,00
713383886 	LMS6	6000	5830	18,00	6100 x 110 x 70	1.539,00
713383888 	LMS8	8000	7830	35,00	8100 x 110 x 70	1.699,00

Aluminium zaagmachines



NEW



Magneetboormachines

fronitall-walt

ACCESSOIRES
p.849



Hoogwaardige magneetboormachine voor continu gebruik.

- Voor gebruik met kernboren van ofwel 25 ofwel 50mm hoogte met 19mm Weldon opname. 50 mm maximale hoogte 60 mm.
- Stabiel boren dankzij een lange pinolen-geleiding.
- Ideaal voor gebruik op bouwerven of moeilijk bereikbare plaatsen.
- Kan ook omgekeerd of schuin gebruikt worden.
- Magneetkracht van 15.000N.
- Met sterke printplaat
- Het koelmiddel wordt doorheen de boor geleid.
- Eenvoudige ombouw voor gebruik van gewone boren.
- **Met snelspanopname.**
- Tot 40% tijds - en energiebesparing met kernboren tegenover klassieke boren.

Als u wenst te boren met volle boren, kunt u volgende optionele toebehoren bij bestellen: boorkopstaart 1/2"x20, 713876001: vervolgens een tandkransboorkop 1,5-13mm, 713876002.

Standaard geleverd met : 1 olietank, 1 olieleiding, 1 zeskantsleutel, 3 handgrepen, 1 draagkoffer, 1 veiligheidsriem.

Order nr.	713860351 M	
Orig. nr.		MB351
Spanning	V	230
Voeding		Manueel
Maximum diameter kernboren	mm	35
Maximum boordiepte kernboren	mm	50
Weldon opname	mm	19
Spilopname		M27
Maximum diameter volle boren	mm	13
Maximum boordiepte volle boren	mm	110
Snelheid	tpm	330
Vermogen motor	kW	1,1
Afmetingen magneetvoet (l x b)	mm	165x80
Magneetcapaciteit	N	15000
Aantal snelheden		1
Gewicht	kg	12,70
Afmetingen (l x b x h)	mm	330 x 260 x 450
Prijs	€	639,00

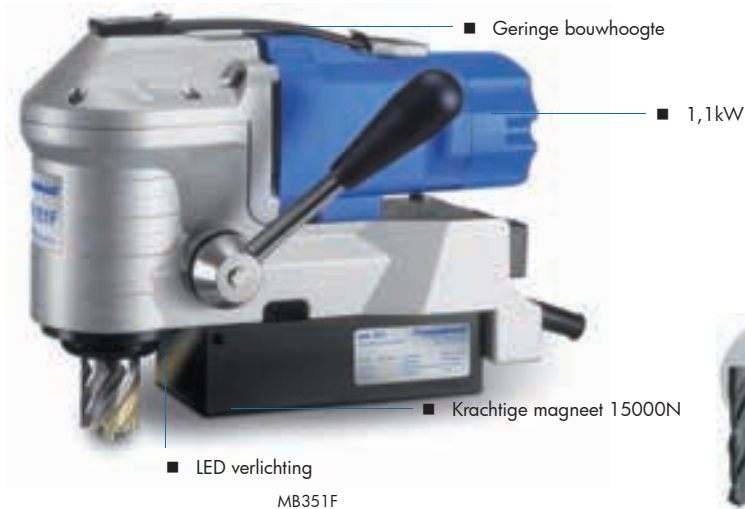

ACCESSOIRES
p.849



Compacte magneetboormachine voor het werken in geringe ruimtes.

- Voor gebruik met kernboren van 25mm hoogte met 19mm Weldon opname.
- Stabiel boren dankzij een krachtige geleiding.
- Ideaal voor gebruik op bouwerven of moeilijk bereikbare plaatsen.
- Kan ook omgekeerd of schuin gebruikt worden.
- Magneetkracht van 15.000 N.
- Tot 40% tijds - en energiebesparing met kernboren tegenover klassieke boren.
- Horizontaal model.
- 1 snelheid. Motor 1,1kW.
- Met LED verlichting voor in donkere, geringe ruimtes
- Bedieningshendel kan zowel links als rechts worden ingezet.

Standaard geleverd met : 1 olietank, 1 olieleiding, 1 zeskantsleutel, 1 handgreep, 1 draagkoffer.

Enkel geschikt voor kernboren met snijlengte van max 25mm.

Order nr.		713860350
Orig. nr.		MB351F
Spanning	V	230
Voeding		Manueel
Maximum diameter kernboren	mm	35
Maximum boordiepte kernboren	mm	30
Weldon opname	mm	19
Spilopname		vast
Snelheid	tpm	390
Vermogen motor	kW	1,1
Afmetingen magneetvoet (l x b)	mm	165x80
Magneetcapaciteit	N	15000
Aantal snelheden		1
Gewicht	kg	13,00
Afmetingen (l x b x h)	mm	200 x 101 x 285
Prijs	€	599,00

MACHINES

metalkraft



MB300 Auto

ACCESSOIRES
p.849



Magneetboormachine met automatische boorvoeding.

- Voor gebruik met kernboren van ofwel 25 ofwel 50mm hoogte met 19mm Weldon opname.
- Stabiel boren dankzij een lange pinolen-geleiding.
- Ideaal voor gebruik op bouwerven.
- Ook omgekeerd of schuin bruikbaar.
- Magneetkracht van 15.000 N.
- Het koelmiddel wordt doorheen de boor geleid.
- Eenvoudige ombouw voor gebruik van gewone boren.
- Tot 40% tijds - en energiebesparing met kernboren tegenover klassieke boren.
- Model met 1 snelheid en uitgerust met 3 automatische voeding en volgens kernboordiameter op de spindel. Motor 1,1 kW.

1 kernboordiameter 12-20mm

2 kernboordiameter 21-24mm

3 kernboordiameter 25-30mm

Standaard geleverd met : 1 olietank, 1 olieleiding, 1 zeskantsleutel 2,5-4-8, 3 handgrepen, 1 draagkoffer, 1 uitdrijfspie.

Enkel geschikt voor kernboren met lengte 25mm.

Order nr.	713860300 M	
Orig. nr.	MB301 AUTO	
Spanning	V	230
Voeding		manueel / auto
Maximum diameter kernboren	mm	35 / 30
Maximum boordiepte kernboren	mm	50 / 45
Weldon opname	mm	19
Spilopname		M27
Maximum diameter volle boren	mm	13 / -
Maximum boordiepte volle boren	mm	110 / -
Snelheid	tpm	350
Vermogen motor	kW	1,1
Afmetingen magneetvoet (l x b)	mm	165x80
Magneetcapaciteit	N	15000
Gewicht	kg	16,50
Afmetingen (l x b x h)	mm	380 x 250 x 450
Prijs	€	1.109,00

NEW
ACCESSOIRES
p.849

metalfort



MB502E



MB502

■ Krachtige 2 kW motor

■ Krachtige 1,1 kW motor

■ 2 snelheden

■ 2 snelheden

■ 17000N

■ 32000N

Krachtige magneetboormachine voor de veeleisende gebruiker.

- Voor gebruik met kernboren van ofwel 25 ofwel 50mm hoogte met 19mm Weldon opname.
- Stabiel boren dankzij een lange pinolen-geleiding.
- Ideaal voor gebruik op bouwerven of moeilijk bereikbare plaatsen.
- Kan ook omgekeerd of schuin gebruikt worden.
- Magneetkracht van 17.000 of 32.000 N.
- Het koelmiddel wordt doorheen de boor geleid.
- Eenvoudige ombouw voor gebruik van gewone boren.

- Met snelspanopname.

- Tot 40% tijds- en energiebesparing met kernboren tegenover klassieke boren.

MB502E is de economischere en lichtere versie tov MB502

Standaard geleverd met : 1 olietank, 1 olieleiding, 1 zeskantsleutel, 3 handgrepen, 1 draagkoffer, 1 veiligheidsriem.

Als u wenst te boren met volle boren, kunt u volgende optionele toebehoren bij bestellen: boorkopstaart 1/2"x20, 713876006, tandkransboorkop 1-16mm, 713876005. Voor de MB502E heeft u een andere boorkopstaart nodig 713876020.

Order nr.		713860500 ^M	713860502 ^M
Orig. nr.		MB502E	MB502
Spanning	V	230	230
Voeding		manueel	
Maximum diameter kernboren	mm	50	50
Maximum boordiepte kernboren	mm	50	75
Weldon opname	mm	19	19
Spilopname		M8	M24
Maximum diameter volle boren	mm	13	16
Maximum boordiepte volle boren	mm	140	110
Snelheid	tpm	180-270	230-300
Vermogen motor	kW	1,1	2
Afmetingen magneetvoet (l x b)	mm	180x90	200x100
Magneetcapaciteit	N	17000	32000
Aantal snelheden		2	2
Gewicht	kg	12,36	22,90
Afmetingen (l x b x h)	mm	330 x 125 x 476	340 x 290 x 570
Prijs	€	699,00	970,00

fractallcraft

MK3

ACCESSOIRES
p.849



Krachtige magneetboormachines met morse konus aansluiting en links/rechtsdraaiend.

- Magneetboormachine voor gebruik met kernboren van ofwel 25 ofwel 50mm hoogte met 19mm Weldon opname.
- Stabiel boren dankzij een lange pinolen-geleiding.
- Ideaal voor gebruik op bouwerven of in staalconstructie of assemblage.
- Ook omgekeerd of schuin bruikbaar.
- Sterke magneetkracht van 32.000 N.
- Het koelmiddel wordt doorheen de kernboor geleid.
- Eenvoudige ombouw voor gebruik van gewone MK3 boren.
- Tot 40% tijds- en energiebesparing met kernboren tegenover klassieke boren.

Standaard geleverd met : 1 olietank, 1 olieleiding, 1 zeskantsleutel 2,5-4-8, 3 handgrepen, 1 draagkoffer, 1 uitdrijfspie, 1 veiligheidsriem, 1 adaptor voor kernboren MK3.

MB754: 2kW motor met 4 snelheden. Links-rechts draaiend.

MB1204: 2kW motor met 4 snelheden; ideaal voor grote diameters tot ø100mm door trage boorsnelheden.

Als u wenst te boren met volle boren, hebt u volgende optionele toebehore, nodig: boorkopstart 713876007, tandkransboorkop 1-16mm, 713876005.

Als uw wenst te tappen, hebt u volgende optionele toebehoren nodig: tapapparaat voor tapkoppen MK3 met M5 - M24 790024020: tapkoppen M5 - M6 790004170

Order nr.		713860754 ^M	713861204 ^M
Orig. nr.		MB754	MB1204
Spanning	V	230	230
Maximum diameter kernboren	mm	75	100
Maximum boordiepte kernboren	mm	50	50
Weldon opname	mm	19	19
Spilopname		MK3	MK3
Maximum diameter volle boren	mm	31	31
Maximum boordiepte volle boren	mm	150	200
Snelheid	tpm	90-120-180-230	35-70-80-140
Vermogen motor	kW	2,0	2,0
Afmetingen magneetvoet (l x b)	mm	200x100	200x100
Magneetcapaciteit	N	32000	32000
Type		links-rechts draaiend	links-rechts draaiend
Aantal snelheden		4	4
Gewicht	kg	24,80	28,31
Afmetingen (l x b x h)	mm	330 x 125 x 476	330 x 125 x 576
Prijs	€	1.179,00	1.855,00



Beugel voor MB754. Geschikt voor montage op buizen. Stabiele uitvoering met stevige ketting.

Order nr.	713867504	
Orig. nr.	3867504	
Capaciteit diameter buizen	mm	ø 32 - ø 203
Gewicht	kg	5,00
Prijs	€	191,00



Tandkrans boorkop met boorsleutel.

Order nr.	200850600	713876005
Voor type	MB351-502E	MB502-MB754-MB1204
Capaciteit	mm	1-16
Spilopname	1/2" x 20, 13	1/2" x 20
Prijs	€	18,50



Boorkop adaptor. Aansluiting 1/2" x 20mm.

Order nr.	713876001	
Orig. nr.	3876001	
Voor type	MB351/MB502E	
Gewicht	kg	0,12
Prijs	€	13,50



Boorkop adaptor.

Order nr.	713876004	
Orig. nr.	3876004	
Voor type	MB502	
Gewicht	kg	0,48
Prijs	€	14,50



Riemaangedreven kolomboormachines

OPTI²



MK2

ACCESSOIRES
p.1014-1091

Tafel- en kolomboormachine met grote uitlading voor hout, kunststof en aluminium.

- Radiaal tafel- en kolomboormachine met riemaandrijving
- Gegarandeerde rondlooptrouwkeurigheid beter dan 0.03 mm gemeten in de boorspindel
- Opname MK2 - Stille kwalitatieve elektromotoren
- Spil met precisie kogellagering
- Rustigere loop door aluminium riemschijven
- Door de getande kwaliteitsaandrijfriemen verkrijgt de machine een aanzienlijk betere krachtoverbrenging en beduidend minder prestatieverlies
- Boordiepte aanslag
- Precies bewerkte werktafel met T-gleuven in diagonaalpatroon, van -45° tot +45° zwenkbaar en 360° draaibaar rond de kolom. D.m.v. van een brede tandlat wordt de tafel eenvoudig in de hoogte versteld
- Massieve, grote bodemplaat met T-gleuven
- Lange, ergonomische stervormige handgreep uit 3 stukken met "soft grip"
- Gebruiksvriendelijke bedieningsknoppen met aparte start- en stopdrukknop en aparte noodstop
- Degelijke booraafscherming uitgerust met veiligheidsschakelaar
- V-snaarkap uitgerust met veiligheidsschakelaar

Standaard geleverd met:

- Tandkrans boorkop 1-16mm B16
- Kegeldoorn volgens DIN228 MK2/B16
- Nederlandstalige handleiding, opschriften, CE - kenmerk, en CE-attest volgens Machine richtlijn 2006/42/CE, Laagspanningsrichtlijn 2006/95/CE en EMC Richtlijn 2004/108/CE

Order nr.		713009161 ^M	713009181 ^M
Orig. nr.		RB6T	RB8S
Spanning	V	1x230	1x230
Vermogen motor	kW	0,750	0,750
Boorcapaciteit in staal S235JR	mm	16	16
Spilopname	MK	2	2
Aantal snelheden		5	5
Spindeltoerental	min-1	390-3000	390-3000
Boordiepte	mm	80	80
Uitlading	mm	115-430	115-430
Diameter kolom	mm	60	70
Afmetingen tafel (b x d)	mm	225x230	262x262
T-gleuven	mm	14	14
Zwenkbaarheid boortafel	°	+/- 45	+/- 45
Draaibaarheid boortafel	°	360	360
Afstand spindel-tafel	mm	380	740
Afstand spindel-voet	mm	550	1250
T-gleuven voet	mm	14	14
Gewicht	kg	40,00	63,00
Afmetingen (l x b x h)	mm	820 x 290 x 930	820 x 290 x 1640
Prijs	€	349,00	409,00



Tafelboormachines - robuust en prijsgunstig

- Tafelboormachines met riemaandrijving.
- Gegarandeerde rondloopnauwkeurigheid beter dan 0.03 mm gemeten in de boorspindel
- Opname vast B16 (geen morse conus opname).
- Spil met precisie kogellagering. - Rustigere loop door aluminium riemschijven.
- Door de getande kwaliteitsaandrijfriemen verkrijgt de machine een aanzienlijk betere krachtoverbrenging en beduidend minder prestatieverlies.
- Boordiepte aanslag.
- Precies bewerkte werktafel met T-gleuven in diagonaalpatroon en centergat, van -45° tot +45° zwenkbaar en 360° draaibaar rond de kolom. D.m.v. van een brede tandlat wordt de tafel eenvoudig in de hoogte versteld.
- Massieve, grote bodemplaat met T-gleuven.
- Gebruiksvriendelijke bedieningsknoppen met aparte start- en stopdrukknop en aparte noodstop.
- Degelijke booraafscherming uitgerust met veiligheidsscharakelaar
- V-snaarkap uitgerust met veiligheidsscharakelaar

Standaard geleverd met:

- Tandkrans boorkop 1-1.3mm
- Nederlandstalige handleiding, opschriften, CE - kenmerk, en CE-attest volgens Machine richtlijn 2006/42/CE, Laagspanningsrichtlijn 2006/95/CE en EMC Richtlijn 2004/108/CE

Order nr.	713008131 ^M	
Orig. nr.		B13
Spanning	V	230
Vermogen motor	kW	0,300
Boorcapaciteit in staal S235JR	mm	13
Boorcapaciteit bij continu gebruik S235JR	mm	12
Spilopname	MK	Vast/B16
Aantal snelheden		5
Spindeltoerental	min-1	520-2620
Boordiepte	mm	50
Uitlading	mm	104
Diameter kolom	mm	46
Afmetingen tafel (b x d)	mm	160x160
T-gleuven	mm	14
Zwenkbaarheid boortafel	°	+/- 45
Draaibaarheid boortafel	°	360
Afstand spindel-tafel	mm	240
Afstand spindel-voet	mm	325
Afmetingen voet (b x d)	mm	135x175
T-gleuven voet	mm	14
Gewicht	kg	19,00
Afmetingen (l x b x h)	mm	420 x 220 x 580
Prijs	€	149,00

Tafel- & kolomboormachines

OPTI



Tafelboormachines - robuust en prijsgunstig

- Tafelboormachines met riemaandrijving.
- Gegarandeerde rondloopnauwkeurigheid beter dan 0.03 mm gemeten in de boorspindel
- Opname vast B16 (geen morse conus opname).
- Stille kwalitatieve elektromotoren.
- Spil met precisie kogellagering.
- Rustigere loop door aluminium riemschijven.
- Door de getande kwaliteitsaandrijfriemen verkrijgt de machine een aanzienlijk betere krachtoverbrenging en beduidend minder prestatieverlies.
- Boordiepte aanslag.
- Precies bewerkte werktafel met T-gleuven in diagonaalpatroon en centergat, van -45° tot +45° zwenkbaar en 360° draaibaar rond de kolom. D.m.v. van een brede tandlat wordt de tafel eenvoudig in de hoogte versteld.
- Massieve, grote bodemplaat met T-gleuven.
- Lange, ergonomische stervormige handgreep uit 3 stukken met "soft grip".
- Gebruiksvriendelijke bedieningsknoppen met aparte start- en stopdrukknop en aparte noodstop.
- Degelijke booraafscherming uitgerust met veiligheidsschakelaar
- V-snaarkap uitgerust met veiligheidsschakelaar

Standaard geleverd met:

- Snelspan boorkop 0-13mm
- 2 T-moeren voor T-gleuf 14mm en draad M12.
- Nederlandstalige handleiding, opschriften, CE - kenmerk, en CE-attest volgens Machine richtlijn 2006/42/CE, Laagspanningsrichtlijn 2006/95/CE en EMC Richtlijn 2004/108/CE

Order nr.	713008141 M	
Orig. nr.		B14
Spanning	V	230
Vermogen motor	kW	0,350
Boorcapaciteit in staal S235JR	mm	14
Boorcapaciteit bij continu gebruik S235JR	mm	12
Spilopname	MK	Vast/B16
Aantal snelheden		5
Spindeltoerental	min-1	520-2620
Boordiepte	mm	50
Uitlading	mm	104
Diameter kolom	mm	46
Afmetingen tafel (b x d)	mm	160x160
T-gleuven	mm	14
Zwenkbaarheid boortafel	°	+/- 45
Draaibaarheid boortafel	°	360
Afstand spindel-tafel	mm	330
Afstand spindel-voet	mm	440
Afmetingen voet (b x d)	mm	140x180
T-gleuven voet	mm	14
Gewicht	kg	21,00
Afmetingen (l x b x h)	mm	420 x 230 x 700
Prijs	€	199,00

MACHINES

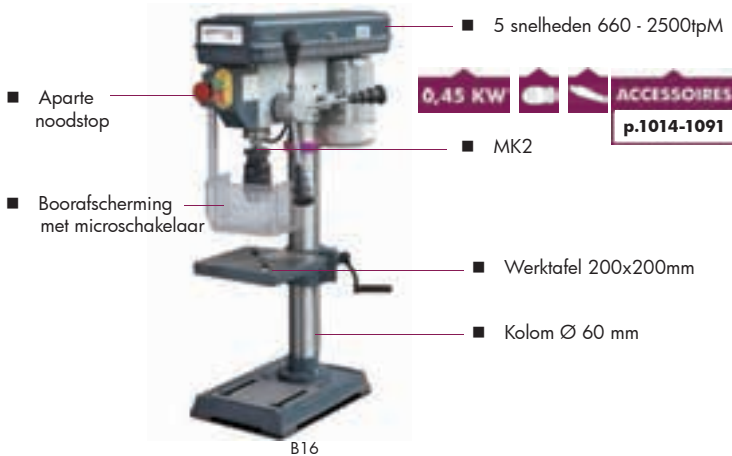

Tafelboormachines - robuust en prijsgunstig

- Tafelboormachines met riemaandrijving.
- Gegarandeerde rondloopnauwkeurigheid beter dan 0.03 mm gemeten in de boorspindel
- Opname MK2.
- Stille kwalitatieve elektromotoren.
- Spil met precisie kogellagering.
- Rustigere loop door aluminium riemschijven.
- Door de getande kwaliteitsaandrijfriemen verkrijgt de machine een aanzienlijk betere krachtoverbrenging en beduidend minder prestatieverlies.
- Boordiepte aanslag.
- Precies bewerkte werktafel met T-gleuven in diagonaalpatroon en centergat, van -45° tot +45° zwenkbaar en 360° draaibaar rond de kolom. D.m.v. van een brede tandlat wordt de tafel eenvoudig in de hoogte veresteld.
- Massieve, grote bodemplaat met T-gleuven.
- Lange, ergonomische stervormige handgreep uit 3 stukken met "soft grip".
- Gebruiksvriendelijke bedieningsknoppen met aparte start- en stopdrukknop en aparte noodstop.
- Degelijke booraafscherming uitgerust met veiligheidsscharakelaar
- V-snaarkap uitgerust met veiligheidsscharakelaar
- De 400 Volt modellen zijn rechts-linksdraaiend. Opmerking: 3x220V = krachtstroom (drijfkracht). Dit is niet hetzelfde als 1x230V mono = wisselstroom

Standaard geleverd met:

- Snelspan boorkop 0-16mm B16
- Kegeldoorn volgens DIN228 MK2/B16
- 2 T-moeren voor T-gleuf 14mm en draad M12.
- Nederlandstalige handleiding, opschriften, CE - kenmerk, en CE-attest volgens Machine richtlijn 2006/42/CE, Laagspanningsrichtlijn 2006/95/CE en EMC Richtlijn 2004/108/CE

Order nr.	713008161 ^M	
Orig. nr.	B16	
Spanning	V	1x230
Vermogen motor	kW	0,450
Boorcapaciteit in staal S235JR	mm	16
Boorcapaciteit bij continu gebruik S235JR	mm	15
Spilopname	MK	2
Aantal snelheden		5
Spindeltoerental	min-1	660-2500
Boordiepte	mm	65
Uitlading	mm	125
Diameter kolom	mm	60
Afmetingen tafel (b x d)	mm	200x200
T-gleuven	mm	14
Zwenkbaarheid boortafel	°	+/- 45
Draaibaarheid boortafel	°	360
Afstand spindel-tafel	mm	390
Afstand spindel-voet	mm	525
Afmetingen voet (b x d)	mm	160x170
T-gleuven voet	mm	14
Gewicht	kg	36,00
Afmetingen (l x b x h)	mm	510 x 270 x 820
Prijs	€	289,00

Tafel- & kolomboormachines

OPTI²



Tafelboormachines - robuust en prijsgunstig

- Tafelboormachines met riemaandrijving.
- Gegarandeerde rondloopenauwkeurigheid beter dan 0.03 mm gemeten in de boorspindel
- Opname MK2.
- Stille kwalitatieve elektromotoren.
- Spil met precisie kogellagering.
- Rustigere loop door aluminium riemschijven.
- Door de getande kwaliteitsaandrijfriemen verkrijgt de machine een aanzienlijk betere krachtoverbrenging en beduidend minder prestatieverlies.
- Boordiepte aanslag.
- Precies bewerkte werktafel met T-gleuven in diagonaalpatroon, van -45° tot +45° zwenkbaar en 360° draaibaar rond de kolom.
- D.m.v. van een brede tandlat wordt de tafel eenvoudig in de hoogte veresteld.
- Massieve, grote bodemplaat met T-gleuven.
- Lange, ergonomische stervormige handgreep uit 3 stukken met "soft grip".
- Gebruiksvriendelijke bedieningsknoppen met aparte start- en stopdrukknop en aparte noodstop.
- Degelijke boorafscherming uitgerust met veiligheidsscharakelaar
- V-snaarkap uitgerust met veiligheidsscharakelaar
- De 400 Volt modellen zijn rechts-linksdraaiend.
- Ook verkrijgbaar in andere voltages: 713008202 - 3x220V

Opmerking: 3x220V = krachtstroom (drijfkracht). Dit is niet hetzelfde als 1x230V mono = wisselstroom

Standaard geleverd met:

- Snelspan boorkop 0-16mm B16
- Kegeldoorn volgens DIN228 MK2/B16
- 2 T-moeren voor T-gleuf 14mm en draad M12.
- Nederlandstalige handleiding, opschriften, CE - kenmerk, en CE-attest volgens Machine richtlijn 2006/42/CE, Laagspanningsrichtlijn 2006/95/CE en EMC Richtlijn 2004/108/CE

Order nr.		713008201 ^M	713008203 ^M
Orig. nr.		B20-230V	B20-400V
Spanning	V	1x230	3x400
Vermogen motor	kW	0,550	0,550
Boorcapaciteit in staal S235JR	mm	20	20
Boorcapaciteit bij continu gebruik S235JR	mm	18	18
Spilopname	MK	2	2
Aantal snelheden		12	12
Spindeltoerental	min-1	210-2220	210-2220
Boordiepte	mm	85	85
Uitlading	mm	170	170
Diameter kolom	mm	70	70
Afmetingen tafel (b x d)	mm	275x275	275x275
T-gleuven	mm	14	14
Zwenkbaarheid boortafel	°	+/- 45	+/- 45
Draaibaarheid boortafel	°	360	360
Afstand spindel-tafel	mm	465	465
Afstand spindel-voet	mm	635	635
Afmetingen voet (b x d)	mm	205x200	205x200
T-gleuven voet	mm	14	14
Gewicht	kg	53,00	53,00
Afmetingen (l x b x h)	mm	700 x 350 x 990	700 x 350 x 990
Prijs	€	379,00	419,00



OPTIUM

Kolomboormachines - robuust en prijsgunstig

- Kolomboormachines met riemaandrijving.
- Gegarandeerde rondlooptrouwkeurigheid beter dan 0.03 mm gemeten in de boorspindel
- Opname MK3, ook in opname MK2.
- Stille kwalitatieve elektromotoren.
- Spil met precisie kogellagering.
- Rustigere loop door aluminium riemschijven.
- Door de getande kwaliteitsaandrijfriemen verkrijgt de machine een aanzienlijk betere krachtoverbrenging en beduidend minder prestatieverlies.
- Boordiepte aanslag.
- Precies bewerkte werktafel met T-gleuven in diagonaalpatroon, van -45° tot +45° zwenkbaar en 360° draaibaar rond de kolom. D.m.v. van een brede tandlat wordt de tafel eenvoudig in de hoogte versteld.
- Massieve, grote bodemplaat met T-gleuven.
- Lange, ergonomische stervormige handgreep uit 3 stukken met "soft grip".
- Gebruiksvriendelijke bedieningsknoppen met aparte start- en stopdrukknop en aparte noodstop.
- Degelijke boorafscherming uitgerust met veiligheidsschakelaar
- V-snaarkap uitgerust met veiligheidsschakelaar
- De 400 Volt modellen zijn rechts-linksdraaiend.
- B25 ook verkrijgbaar in andere voltages: 71300825 - 3x220V Opmerking: 3x220V = krachtstroom (drijfkracht). Dit is niet hetzelfde als 1x230V mono = wisselstroom

Standaard geleverd met:

- Snelspan boorkop 0-16mm B16
- Kegeldoorn volgens DIN228 MK3/B16
- 2 T-moeren voor T-gleuf 14mm en draad M12.
- Nederlandstalige handleiding, opschriften, CE - kenmerk, en CE-attest volgens Machine richtlijn 2006/42/CE, Laagspanningsrichtlijn 2006/95/CE en EMC Richtlijn 2004/108/CE



Order nr.		713008257 M	713008251 M	713008253 M
Orig. nr.		B25-2-230V	B25-3-230V	B25-3-400V
Spanning	V	1x230	1x230	3x400
Vermogen motor	kW	0,550	0,550	0,550
Boorcapaciteit in staal S235JR	mm	20	20	20
Boorcapaciteit bij continu gebruik S235JR	mm	18	18	18
Spilopname	MK	2	3	3
Aantal snelheden		12	12	12
Spindeltoerental	min-1	210-2220	210-2220	210-2220
Boordiepte	mm	85	85	85
Uitlading	mm	170	170	170
Diameter kolom	mm	70	70	70
Afmetingen tafel (b x d)	mm	275x275	275x275	275x275
T-gleuven	mm	14	14	14
Zwenkbaarheid boortafel	°	+/- 45	+/- 45	+/- 45
Draaibaarheid boortafel	°	360	360	360
Afstand spindel-tafel	mm	760	760	760
Afstand spindel-voet	mm	1210	1210	1210
Afmetingen voet (b x d)	mm	235x220	235x220	235x220
T-gleuven voet	mm	14	14	14
Gewicht	kg	60,00	60,00	60,00
Afmetingen (l x b x h)	mm	690 x 390 x 1570	690 x 390 x 1570	690 x 390 x 1570
Prijs	€	479,00	489,00	479,00

OPTIMA

Kolomboormachines - robuust en prijsgunstig

- Kolomboormachines met riemaandrijving.
- Gegarandeerde rondloopnauwkeurigheid beter dan 0.03 mm gemeten in de boorspindel
- Opname MK3 of MK4.
- Stille kwalitatieve elektromotoren.
- Spil met precisie kogellagering.
- Rustigere loop door aluminium riemschijven.
- Door de getande kwaliteitsaandrijfriemen verkrijgt de machine een aanzienlijk betere krachtoverbrenging en beduidend minder prestatieverlies.
- Boordiepte aanslag.
- Precies bewerkte werktafel met T-gleuven in diagonaalpatroon, van -45° tot +45° zwenkbaar en 360° draaibaar rond de kolom. D.m.v. van een brede tandlat wordt de tafel eenvoudig in de hoogte veresteld.
- Massieve, grote bodemplaat met T-gleuven.
- Lange, ergonomische stervormige handgreep uit 3 stukken met "soft grip".
- Gebruiksvriendelijke bedieningsknopen met aparte start- en stopdrukknop en aparte noodstop.
- Degelijke boorafscherming uitgerust met veiligheidsschakelaar
- V-snaarkap uitgerust met veiligheidsschakelaar
- De 400 Volt modellen zijn rechts-linksdraaiend.
- B32 ook verkrijgbaar in andere voltages: 713008322 - 3x220V;

Opmerking: 3x220V = krachtstroom (drijfkracht). Dit is niet hetzelfde als 1x230V mono = wisselstroom

Order nr.		713008327 ^M	713008328 ^M	713008321 ^M	713008323 ^M
Orig. nr.		B32-3-230V	B32-3-400V	B32-4-230V	B32-4-400V
Spanning	V	1x230	3x400	1x230	3x400
Vermogen motor	kW	1,1	1,1	1,1	1,1
Boorcapaciteit in staal S235JR	mm	32	32	32	32
Boorcapaciteit bij continu gebruik S235JR	mm	28	28	28	28
Spilopname	MK	3	3	4	4
Aantal snelheden		9	9	9	9
Spindeltoerental	min-1	140-2020	140-2020	140-2020	140-2020
Boordiepte	mm	85	85	85	85
Uitlading	mm	225	225	225	225
Diameter kolom	mm	92	92	92	92
Afmetingen tafel (b x d)	mm	360x360	360x360	360x360	360x360
T-gleuven	mm	14	14	14	14
Zwenkbaarheid boortafel	°	+/- 45	+/- 45	+/- 45	+/- 45
Draaibaarheid boortafel	°	360	360	360	360
Afstand spindel-tafel	mm	600	600	600	600
Afstand spindel-voet	mm	1170	1170	1170	1170
Afmetingen voet (b x d)	mm	260x270	260x270	260x270	260x270
T-gleuven voet	mm	14	14	14	14
Gewicht	kg	135,00	135,00	135,00	113,00
Afmetingen (l x b x h)	mm	790 x 400 x 1730	790 x 400 x 1730	790 x 400 x 1730	790 x 400 x 1730
Prijs	€	799,00	799,00	799,00	799,00

B32

MK4



■ Aparte noodstop

■ Rondlooptrouwkeurigheid
beter dan 0,03mm

■ Massieve werktafel
360x360 mm

■ Kolomdiameter Ø 92mm

■ Massieve bodemplaat
met T-gleuven

■ 9 snelheden
140 - 2020rpm

■ V-snaarkop met
microschakelaar

■ Zware 1,1 kw
motor

1,1 KW



NU OOK IN MK3

ACCESSOIRES

p.1014-1091

■ Booraafscherming met
microschakelaar

■ Brede tandlat

Standaard geleverd met :

- Snelspan boorkop 0-16mm B16
- Kegeldoorn volgens DIN228 MK4/B16
- 2 T-moeren voor T-gleuf 14mm en draad M12.
- Nederlandstalige handleiding, opschriften, CE - kenmerk, en CE-attest volgens Machine richtlijn 2006/42/CE, Laagspanningsrichtlijn 2006/95/CE en EMC Richtlijn 2004/108/CE

**OPTIE**

Tafelboormachines voor de werkplaats en onderhoudsdienst

- Tafelboormachines met riemaandrijving.
- Gegarandeerde rondloopenauwkeurigheid kleiner dan 0.02 mm gemeten in de boorspindel
- Opname MK2.
- Stille kwalitatieve elektromotoren.
- Spil met precisie kogellagering.
- Rustigere loop door aluminium riemschijven.
- Door de getande kwaliteitsaandrijfriemen verkrijgt de machine een aanzienlijk betere krachtoverbrenging en beduidend minder prestatieverlies.
- Boordiepte aanslag.
- Precies bewerkte werktafel met T-gleuven in diagonaalpatroon, van -45° tot +45° zwenkbaar en 360° draaibaar rond de kolom.
- D.m.v. van een brede tandlat wordt de tafel eenvoudig in de hoogte vasteld.
- Massieve, grote bodemplaat met T-gleuven.
- Aluminium handgreep uit één stuk met "soft grip".
- Gebruiksvriendelijke bedieningsknoppen met aparte start- en stopdrukknop en aparte noodstop.
- Degelijke boorafscherming uitgerust met veiligheidsschakelaar
- V-snaarkap uitgerust met veiligheidsschakelaar

Order nr.		713003171 ^M
Orig. nr.		B17PRO
Spanning	V	230
Vermogen motor	kW	0,500
Boorcapaciteit in staal S235JR	mm	16
Boorcapaciteit bij continu gebruik S235JR	mm	12
Spilopname	MK	2
Aantal snelheden		5
Spindeltoerental	min-1	500-2520
Boordiepte	mm	65
Uitlading	mm	152
Diameter kolom	mm	60
Afmetingen tafel (b x d)	mm	235x220
T-gleuven	mm	12
Zwenkbaarheid boortafel	°	+/- 45
Draaibaarheid boortafel	°	360
Afstand spindel-tafel	mm	325
Afstand spindel-voet	mm	530
Afmetingen voet (b x d)	mm	245x400
T-gleuven voet	mm	16
Gewicht	kg	39,00
Afmetingen (l x b x h)	mm	600 x 260 x 860
Prijs	€	349,00

B17PRO

MK2



Standaard geleverd met :

- Röhm snelspan boorkop 3-16mm B16
- Kegeldoorn volgens DIN228 MK2
- 2 T-moeren voor T-gleuf 12mm en draad M10.
- Nederlandstalige handleiding, opschriften, CE - kenmerk, en CE-attest volgens Machine richtlijn 2006/42/CE, Laagspanningsrichtlijn 2006/95/CE en EMC Richtlijn 2004/108/CE



Tafelboormachines voor de werkplaats en onderhoudsdienst

- Tafelboormachines met riemaandrijving.
 - Gegarandeerde rondlooptrouwkeurigheid kleiner dan 0.02 mm gemeten in de boorspindel
 - Opname MK2.
 - Stille kwalitatieve elektromotoren.
 - Spil met precisie kogellagering.
 - Rustigere loop door aluminium riemschijven.
 - Door de getande kwaliteitsaandrijfriemen verkrijgt de machine een aanzienlijk betere krachtoverbrenging en beduidend minder prestatieverlies.
 - Boordiepte aanslag.
 - Precies bewerkte werktafel met T-gleuven in diagonaalpatroon, van -45° tot +45° zwenkbaar en 360° draaibaar rond de kolom.
- D.m.v. van een brede tandlat wordt de tafel eenvoudig in de hoogte vasteld.
- Massieve, grote bodemplaat met T-gleuven.
 - Aluminium handgreep uit één stuk met "soft grip".
 - Gebruiksvriendelijke bedieningsknopen met aparte start- en stopdrukknop en aparte noodstop.
 - Degelijke boorafscherming uitgerust met veiligheidsschakelaar
 - V-snaarkap uitgerust met veiligheidsschakelaar
 - De 400 Volt modellen zijn rechts-linksdraaiend.
 - B23Pro ook verkrijgbaar in andere voltages: 713003234 - 3x220V; 713003232 - 3x440V

Opmerking: 3x220V = krachtstroom (drijfkracht). Dit is niet hetzelfde als 1x230V mono = wisselstroom

Order nr.		713003231 ^M	713003233 ^M
Orig. nr.		B23PRO-230V	B23PRO-400V
Spanning	V	1x230	3x400
Vermogen motor	kW	0,750	0,750
Boorcapaciteit in staal S235JR	mm	25	25
Spilopname	MK	2	2
Aantal snelheden		12	12
Spindeloorental	min-1	200-2440	200-2440
Boordiepte	mm	80	80
Uitlading	mm	180	180
Diameter kolom	mm	73	73
Afmetingen tafel (b x d)	mm	280x250	280x250
T-gleuven	mm	12	12
Zwenkbaarheid boortafel	°	+/- 45	+/- 45
Draaibaarheid boortafel	°	360	360
Afstand spindel-tafel	mm	360	360
Afstand spindel-voet	mm	610	610
T-gleuven voet	mm	16	16
Gewicht	kg	66,00	66,00
Afmetingen (l x b x h)	mm	650 x 320 x 1010	650 x 320 x 1010
Prijs	€	539,00	549,00

B23PRO

MK2

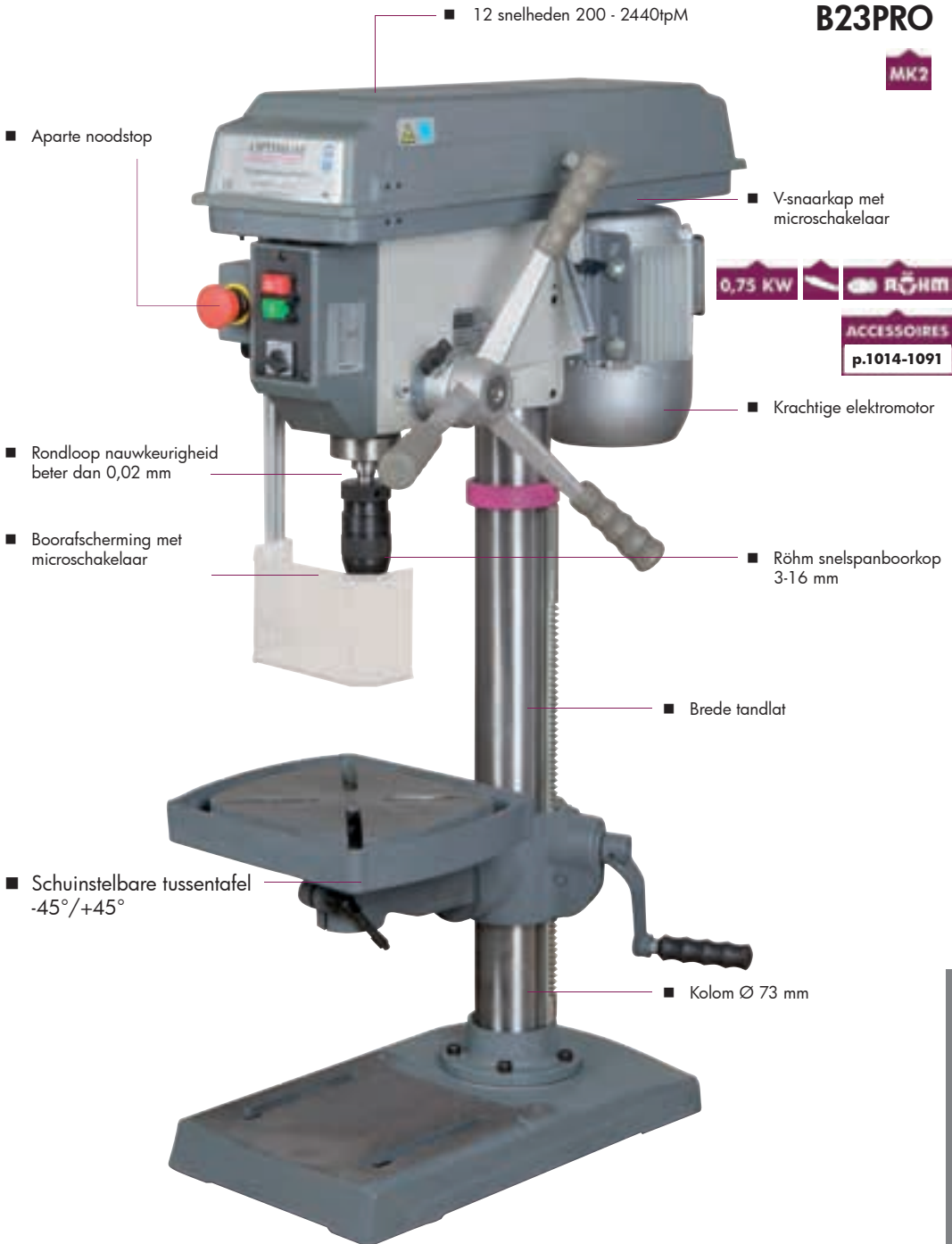

Standaard geleverd met :

- Röhmspan boorkop 3-16mm B16
- Kegeldoorn volgens DIN228 MK2
- 2 T-moeren voor T-gleuf 12mm en draad M10.
- Nederlandstalige handleiding, opschriften, CE - kenmerk, en CE-attest volgens Machine richtlijn 2006/42/CE, Laagspanningsrichtlijn 2006/95/CE en EMC Richtlijn 2004/108/CE



Kolomboormachine voor de werkplaats en onderhoudsdienst

- Tafelboormachines met riemaandrijving.
 - Gegarandeerde rondloopnauwkeurigheid kleiner dan 0.02 mm gemeten in de boorspindel
 - Opname MK3.
 - Stille kwalitatieve elektromotoren.
 - Spil met precisie kogellagering.
 - Rustigere loop door aluminium riemschijven (3).
 - Door de getande kwaliteitsaandrijfriemen verkrijgt de machine een aanzienlijk betere krachtoverbrenging en beduidend minder prestatieverlies.
 - Boordiepte aanslag.
 - Precies bewerkte werktafel met T-gleuven in diagonaalpatroon, van -45° tot +45° zwenkbaar en 360° draaibaar rond de kolom.
- D.m.v. van een brede tandlat wordt de tafel eenvoudig in de hoogte vasteld.
- Massieve, grote bodemplaat met T-gleuven.
 - Aluminium handgreep uit één stuk met "soft grip".
 - Gebruiksvriendelijke bedieningsknopen met aparte start- en stopdrukknop en aparte noodstop.
 - Degelijke boorafscherming uitgerust met veiligheidsschakelaar
 - V-snaarkap uitgerust met veiligheidsschakelaar
 - De 400 Volt modellen zijn rechts-linksdraaiend.
 - B26Pro ook verkrijgbaar in andere voltages: 713003262 - 3x220V; 713003268 – 3x440V

Opmerking: 3x220V = krachtstroom (drijfkracht). Dit is niet hetzelfde als 1x230V mono = wisselstroom

Order nr.		713003261 ^M	713003263 ^M
Orig. nr.		B26PRO-230V	B26PRO-400V
Spanning	V	1x230	3x400
Vermogen motor	kW	0,75	0,75
Boorcapaciteit in staal S235JR	mm	25	25
Boorcapaciteit bij continu gebruik S235JR	mm	20	20
Spilopname	MK	3	3
Aantal snelheden		12	12
Spindeltoerental	min-1	200-2440	200-2440
Boordiepte	mm	85	85
Uitlading	mm	210	210
Diameter kolom	mm	80	80
Afmetingen tafel (b x d)	mm	330x290	330x290
T-gleuven	mm	14	14
Zwenkbaarheid boortafel	°	+/-45	+/-45
Draaibaarheid boortafel	°	360	360
Afstand spindel-tafel	mm	720	720
Afstand spindel-voet	mm	1230	1230
Afmetingen voet (b x d)	mm	325x500	325x500
T-gleuven voet	mm	16	16
Gewicht	kg	82,00	82,00
Afmetingen (l x b x h)	mm	700 x 350 x 1670	700 x 350 x 1670
Prijs	€	619,00	619,00

B26PRO

MK3

- 
- Aparte noodstop
 - Rondloop nauwkeurigheid beter dan 0,02 mm
 - Booraafscherming met microschakelaar
 - Schuinstelbare tussentafel -45°/+45°
 - 3 Aluminium riemschijven 12 spilsnelheden
 - Links/rechts schakelaar bij 3x400V
 - Soft grip
 - Röhmlin snelspanboorkop 3-16 mm
 - Brede tandlat
 - Zware bodemplaat

Standaard geleverd met :

- Röhmlin snelspan boorkop 3-16mm B16
- Kegeldoorn volgens DIN228 MK3
- 2 T-moeren voor T-gleuf 14mm en draad M12.
- Nederlandstalige handleiding, opschriften, CE - kenmerk, en CE-attest volgens Machine richtlijn 2006/42/CE, Laagspanningsrichtlijn 2006/95/CE en EMC Richtlijn 2004/108/CE. Richtlijn 2002/95/CE beperking van het gebruik van bepaalde gevaarlijke stoffen in elektrische en elektronische apparatuur.



Kolomboormachine voor de werkplaats en onderhoudsdienst

- Tafelboormachines met riemaandrijving.
- Gegarandeerde rondloopnauwkeurigheid kleiner dan 0.02 mm gemeten in de boorspindel
- Opname MK4.
- Stille kwalitatieve elektromotoren.
- Spil met precisie kogellagering.
- Rustigere loop door aluminium riemschijven (3).
- Door de getande kwaliteitsaandrijfriemen verkrijgt de machine een aanzienlijk betere krachtoverbrenging en beduidend minder prestatieverlies.
- Boordiepte aanslag.
- Precies bewerkte werktafel met T-gleuven in diagonaalpatroon, van -45° tot +45° zwenkbaar en 360° draaibaar rond de kolom. D.m.v. van een brede tandlat wordt de tafel eenvoudig in de hoogte vasteld.
- Massieve, grote bodemplaat met T-gleuven.
- Aluminium handgreep uit één stuk met "soft grip".
- Gebruiksvriendelijke bedieningsknopen met aparte start- en stopdrukknop en aparte noodstop.
- Degelijke boorafscherming uitgerust met veiligheidsschakelaar
- V-snaarkap uitgerust met veiligheidsschakelaar
- De 400 Volt modellen zijn rechts-linksdraaiend.
- B33Pro ook verkrijgbaar in andere voltages: 713003332 - 3x220V

Opmerking: 3x220V = krachtstroom (drijfkracht). Dit is niet hetzelfde als 1x230V mono = wisselstroom

Order nr.		713003331 ^M	713003333 ^M
Orig. nr.		B33PRO-230V	B33PRO-400V
Spanning	V	1x230	3x400
Vermogen motor	kW	1,1	1,1
Boorcapaciteit in staal S235JR	mm	30	30
Boorcapaciteit bij continu gebruik S235JR	mm	25	25
Spilopname	MK	4	4
Aantal snelheden		9	9
Spindeltoerental	min-1	120-1810	120-1810
Boordiepte	mm	120	120
Uitlading	mm	254	254
Diameter kolom	mm	92	92
Afmetingen tafel (b x d)	mm	475x425	475x425
T-gleuven	mm	14	14
Zwenkbaarheid boortafel	°	+/- 45	+/- 45
Draaibaarheid boortafel	°	360	360
Afstand spindel-tafel	mm	695	695
Afstand spindel-voet	mm	1180	1180
Afmetingen voet (b x d)	mm	450x570	450x570
T-gleuven voet	mm	16	16
Gewicht	kg	135,00	135,00
Afmetingen (l x b x h)	mm	860 x 480 x 1720	860 x 480 x 1720
Prijs	€	979,00	979,00



B33PRO



■ Aparte noodstop

■ Rondloop nauwkeurigheid beter dan 0,02 mm

■ Boorafscherming met microscharakelaar

■ Groot gedimensioneerde werktafel 450x570 mm

■ 3 Aluminium riemschijven
9 spilsnelheden

■ Krachtige elektromotor
■ Links/rechts omschakelaar bij 3x400V

1,1 KW



ACCESSOIRES

p.1014-1091

■ Soft grip

■ Röhm snelspanboorkop 3-16 mm

■ Brede tandlat

■ Zware bodemplaat



Standaard geleverd met :

- Röhm snelspan boorkop 3-16mm B16
- Kegeldoorn volgens DIN228 MK4
- 2 T-moeren voor T-gleuf 14mm en draad M12.
- Nederlandstalige handleiding, opschriften, CE - kenmerk, en CE-attest volgens Machine richtlijn 2006/42/CE, Laagspanningsrichtlijn 2006/95/CE en EMC Richtlijn 2004/108/CE. Richtlijn 2002/95/CE beperking van het gebruik van bepaalde gevaarlijke stoffen in elektrische en elektronische apparatuur.



Tafel- en kolomboormachines met Vario voor de werkplaats en onderhoudsdienst

- Tafelboormachines met riemaandrijving.
- Uitergest met hoogwaardige Duitse "LENZE" elektronische vario-motor met frequentieomvormer voor een traploos regelbaar toerental.
- Gegarandeerde rondlooptrouwkeurigheid kleiner dan 0.02 mm gemeten in de boorspindel
- Opname B23Pro Vario: MK2, B26Pro Vario: MK3 en B33Pro Vario: MK4
- Stille kwalitatieve elektromotoren.
- Spil met precisie kogellagering.
- Rustigere loop door aluminium riemschijven (3).
- Door de getande kwaliteitsaandrijfriemen verkrijgt de machine een aanzienlijk betere krachtoverbrenging en beduidend minder prestatieverlies.
- Boordiepte aanslag.
- Precies bewerkte werktafel met T-gleuven in diagonaalpatroon, van -45° tot +45° zwenkbaar en 360° draaibaar rond de kolom.
- D.m.v. van een brede tandlat wordt de tafel eenvoudig in de hoogte vasteld.
- Massieve, grote bodemplaat met T-gleuven.
- Aluminium handgreep uit één stuk met "soft grip".
- Gebruiksvriendelijke bedieningsknopen met aparte start- en stopdrukknop en aparte noodstop.
- Degelijke booraafscherming uitgerust met veiligheidsschakelaar
- V-snaarkap uitgerust met veiligheidsschakelaar
- Vario ook verkrijgbaar in andere voltages: 3x220V en 3x440V

Opmerking: 3x220V = krachtstroom (drijfkracht). Dit is niet hetzelfde als 1x230V mono = wisselstroom

Order nr.		713011233	713011263	713011333
Orig. nr.		B23PRO VARIO	B26PRO VARIO	B33PRO VARIO
Spanning	V	3x400	3x400	3x400
Vermogen motor	kW	0,750	0,750	1,5
Boorcapaciteit in staal S235JR	mm	25	25	30
Boorcapaciteit bij continu gebruik S235JR	mm	20	20	25
Spilopname	MK	2	3	4
Aantal snelheden		12 (traploos)	12 (traploos)	9 (traploos)
Spindeltoerental	min-1	30-3500	30-3500	20-3500
Boordiepte	mm	80	85	120
Uitlading	mm	180	210	254
Diameter kolom	mm	73	80	92
Afmetingen tafel (b x d)	mm	280x245	330x290	475x425
T-gleuven	mm	12	14	14
Zwenkbaarheid boortafel	°	+/- 45	+/- 45	+/- 45
Draaibaarheid boortafel	°	360	360	360
Afstand spindel-tafel	mm	360	720	695
Afstand spindel-voet	mm	610	1230	1180
Afmetingen voet (b x d)	mm	265x460	325x500	450x570
T-gleuven voet	mm	16	16	16
Gewicht	kg	75,00	90,00	140,00
Afmetingen (l x b x h)	mm	660 x 320 x 1010	710 x 350 x 1670	870 x 480 x 1720
Prijs	€	1.395,00	1.499,00	1.899,00

B23-B26-B33PRO VARIO

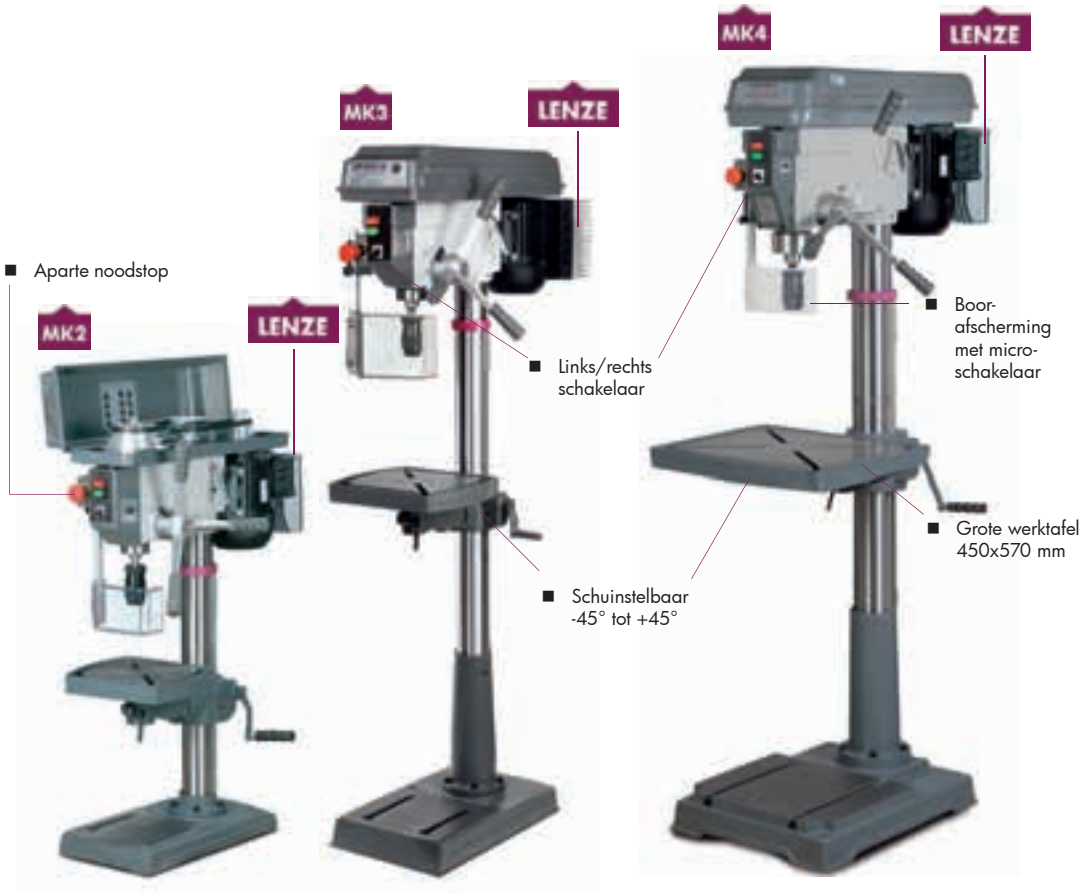

■ 12 spilsnelheden
30-3500
B23 PRO VARIO

■ 12 spilsnelheden
30-3500
B26 PRO VARIO

■ 9 spilsnelheden
20-3500
B33 PRO VARIO



Standaard geleverd met :

- Röhm snelspan boorkop 3-16mm B16
- Kegeldoorn afhankelijk van boormachine volgens DIN228 MK2 of MK3 of MK4
- 2 T-moeren voor T-gleuf 12mm en draad M10 voor B23Pro Vario. Voor de andere 14 mm en draad M12
- Nederlandstalige handleiding, opschriften, CE - kenmerk, en CE-attest volgens Machine richtlijn 2006/42/CE, Laagspanningsrichtlijn 2006/95/CE en EMC Richtlijn 2004/108/CE



Professionele tafelboormachine voor de betere werkplaats of opleidingscentra. B16H Vario met variabele, traploos regelbare spilsnelheden tot 7.500 tpm

- Tafelboormachines met riemaandrijving.
- Gegarandeerde rondlooptrouwkeurigheid van 0.015 mm gemeten in de boorspindel
- Opname MK2.
- Stille kwalitatieve elektromotoren.
- Spil met precisie kogellagering.
- Rustigere loop door aluminium riemschijven.
- Door de getande kwaliteitsaandrijfriemen verkrijgt de machine een aanzienlijk betere krachtoverbrenging en beduidend minder prestatieverlies. 7M industriële V-riem, gegarandeerde levensduur van de riem tot 10.000 werkuren.
- Boordiepte aanslag.
- Zware, precies bewerkte werktafel met T-gleuven in diagonaalpatroon en 360° draaibaar rond de kolom. D.m.v. van een brede tandlat wordt de tafel eenvoudig in de hoogte vasteld.
- Massieve, grote bodemplaat met T-gleuven.
- Lange, Gegoten Aluminium handgreep uit één stuk met "soft grip".
- Gebruiksvriendelijke bedieningsknopen met aparte start- en stopdrukknop en aparte noodstop.
- Degelijke boorafscherming uitgerust met veiligheidsschakelaar
- V-snaarkap uitgerust met veiligheidsschakelaar
- Digitale LED display voor de spilsnelheden (enkel op B16H Vario)

- Volledige gemonteerde machine

Order nr.		713020217 ^M	713020218 ^M
Orig. nr.		B16H 400V	B16HV
Spanning	V	400V	1x230
Vermogen motor	kW	0.550	1,5
Boorcapaciteit in staal S235JR	mm	13	16
Boorcapaciteit bij continu gebruik S235JR	mm	11	13
Spilopname	MK	2	2
Aantal snelheden		5	5 (traploos)
Spindeltoerental	min-1	450-3.500	100-7.500
Boordiepte	mm	65	65
Uitlading	mm	130	130
Diameter kolom	mm	60	60
Afmetingen tafel (b x d)	mm	230x245	230x245
T-gleuven	mm	12	12
Draaibaarheid boortafel	°	360	360
Afstand spindel-tafel	mm	370	370
Afstand spindel-voet	mm	495	495
Afmetingen voet (b x d)	mm	200x240	200x240
T-gleuven voet	mm	12	12
Gewicht	kg	65,00	68,00
Afmetingen (l x b x h)	mm	549 x 300 x 848	600 x 360 x 1000
Prijs	€	599,00	1.429,00



- 7M Kwaliteitsriemen

B16H-B16H VARIO

MK2

ACCESSOIRES

p.1014-1091

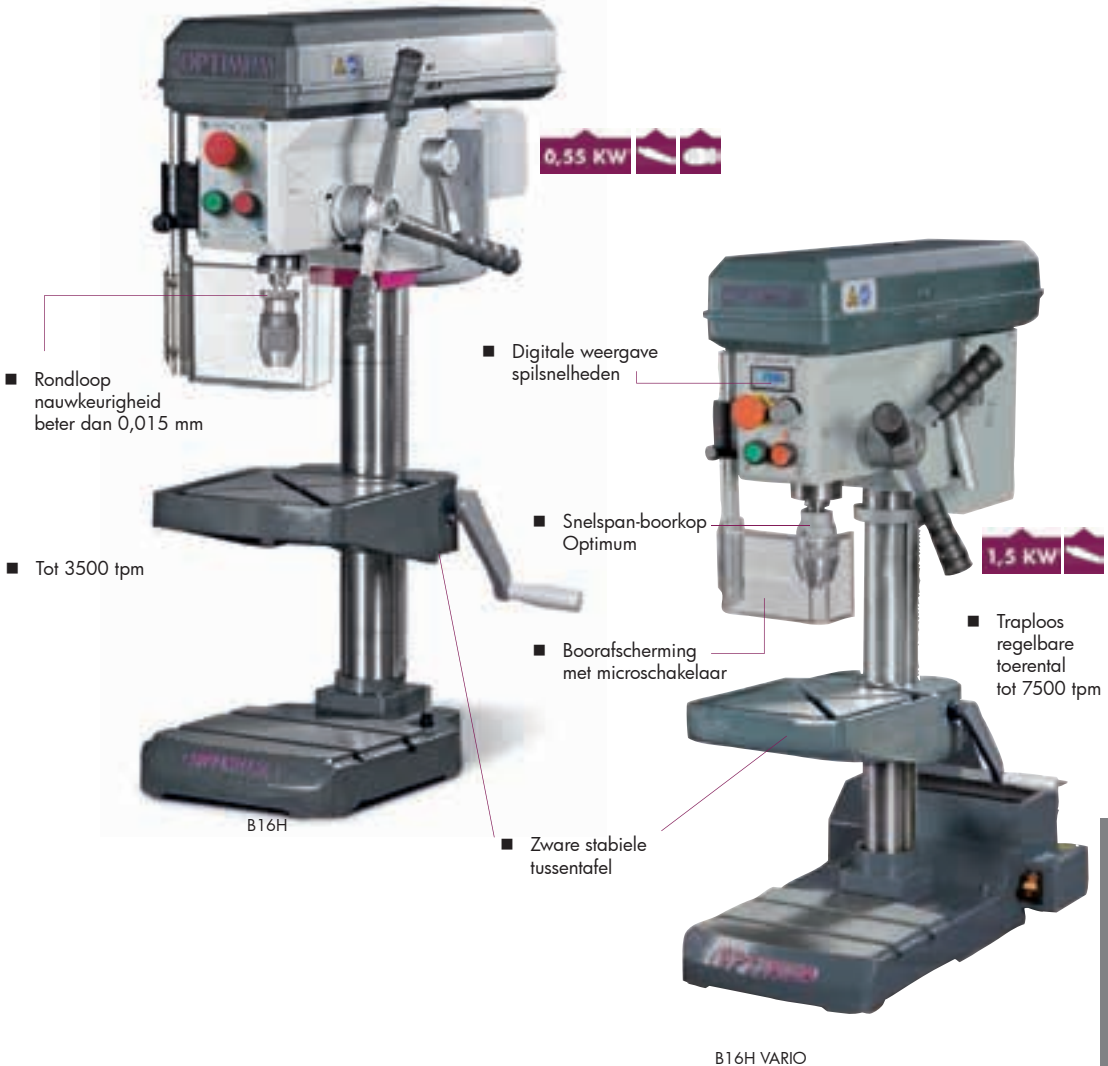

Standaard geleverd met :

- Optimum snelspan boorkop 1-13 mm B16
- Kegeldoorn volgens DIN228 MK2
- 2 T-moeren voor T-gleuf 12mm en draad M10.
- Nederlandstalige handleiding, opschriften, CE - kenmerk, en CE-attest volgens Machine richtlijn 2006/42/CE, Laagspanningsrichtlijn 2006/95/CE en EMC Richtlijn 2004/108/CE



OPTI

Professionele tafelboormachine voor de betere werkplaats of opleidingscentra. B24H Vario. Met variabele, traploos regelbare spijlsnelheden tot 5.950 tpm

- Tafelboormachines met riemaandrijving.
- Gegarandeerde rondloopnauwkeurigheid van 0.015 mm gemeten in de boorspindel
- Opname MK2.
- Stille kwalitatieve elektromotoren.
- Spil met precisie kogellagering.
- Rustigere loop door aluminium riemschijven.
- Door de getande kwaliteitsaandrijfriemen verkrijgt de machine een aanzienlijk betere krachtoverbrenging en beduidend minder prestatieverlies. 7M industriële V-riem, gegarandeerde levensduur van de riem tot 10.000 werkuren.
- Boordiepte aanslag.
- Zware, precies bewerkte werktafel met T-gleuven in diagonaalpatroon en 360° draaibaar rond de kolom, voorzien van dubbele klemming. D.m.v. van een brede tandlat wordt de tafel eenvoudig in de hoogte vasteld.
- Massieve, grote bodemplaat met T-gleuven.
- Ingewerkte machineverlichting
- Lange, Gegoten Aluminium handgreep uit één stuk met "soft grip".
- Gebruiksvriendelijke bedieningsknoppen met aparte start- en stopdrukknop en aparte noodstop. - Degelijke booraafscherming uitgerust met veiligheidsschakelaar
- V-snaarkap uitgerust met veiligheidsschakelaar
- Alle modellen zijn links - rechtsdraaiend ook 230V modellen
- Digitale LED display voor de spijlsnelheden (enkel op B24H Vario)
- Traploos regelbare spijlsnelheden tot 5.950 tpm (enkel op B24H Vario)
- 3x220V model enkel mogelijk met transformator

Opmerking: 3x220V = krachtstroom (drijfkracht). Dit is niet hetzelfde als 1x230V mono = wisselstroom

Order nr.		713020241 ^M	713020243 ^M	713020245 ^M
Orig. nr.		B24H 230V	B24H 400V	B24HV
Spanning	V	1x230	3x400	1x230
Vermogen motor	kW	0,850	0,850	1,5
Boorcapaciteit in staal S235JR	mm	24	24	24
Boorcapaciteit bij continu gebruik S235JR	mm	20	20	20
Spilopname	MK	2	2	2
Aantal snelheden		7	7	4 (traploos)
Spindeltoerental	min-1	350-4000	350-4000	100-5950
Boordiepte	mm	85	85	85
Uitlading	mm	165	165	165
Diameter kolom	mm	80	80	80
Afmetingen tafel (b x d)	mm	280x300	280x300	280x300
T-gleuven	mm	14	14	14
Draaibaarheid boortafel	°	360	360	360
Afstand spindel-tafel	mm	515	515	515
Afstand spindel-voet	mm	681	681	681
Afmetingen voet (b x d)	mm	280x260	280x260	280x260
T-gleuven voet	mm	14	14	14
Gewicht	kg	84,00	84,00	85,00
Afmetingen (l x b x h)	mm	665 x 434 x 998	665 x 434 x 998	665 x 434 x 998
Prijs	€	1.119,00	1.159,00	2.090,00

B24H-B24H VARIO

MK2

ACCESSOIRES

p.1014-1091



- 7M Kwaliteitsriemen

- Gegarandeerderondloop nauwkeurigheid beter dan 0,015 mm

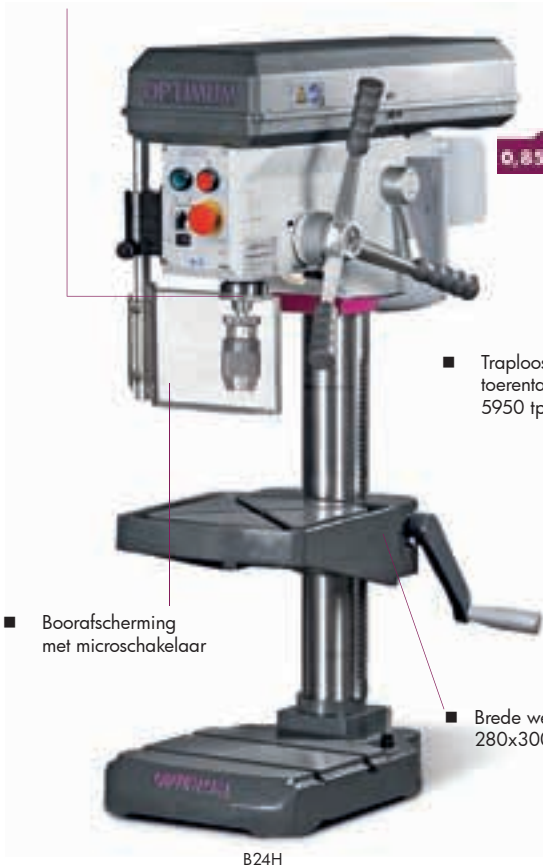

- Boorafscherming met microscharrelaar

B24H

0,85 KW



84kg

- Traploos regelbaar toerental tot 5950 tpm

- Brede werktafel 280x300mm

- Digitale weergave spijlsnelheden

- Links/rechts 2 snelheden

1,5 KW



VARIO

- Snelspanboorkop Optimum

- Kolom Ø 80 mm

B24H Vario

Standaard geleverd met :

- Optimum snelspan boorkop 1-16 mm B16
- Kegeldoorn volgens DIN228 MK2
- 2 T-moeren voor T-gleuf 14mm en draad M12.
- Nederlandstalige handleiding, opschriften, CE - kenmerk, en CE-attest volgens Machine richtlijn 2006/42/CE, Laagspanningsrichtlijn 2006/95/CE en EMC Richtlijn 2004/108/CE

OPTIC

Professionele kolomboormachine voor de betere werkplaats of opleidingscentra. B28H Vario. Met variabele, traploos regelbare spilsnelheden tot 5.600 tpm

- Kolomboormachines met riemaandrijving.
- Gegarandeerde rondloopnauwkeurigheid van 0.015 mm gemeten in de boorspindel
- Opname MK3.
- Stille kwalitatieve elektromotoren.
- Spil met precisie kogellagering.
- Rustigere loop door aluminium riemschijven.
- Door de getande kwaliteitsaandrijfriemen verkrijgt de machine een aanzienlijk betere krachtoverbrenging en beduidend minder prestatieverlies. 7M industriële V-riem, gegarandeerde levensduur van de riem tot 10.000 werkuren.
- Boordiepte aanslag.
- Zware, precies bewerkte werktafel met T-gleuven in diagonaalpatroon en 360° draaibaar rond de kolom, voorzien van dubbele klemming. D.m.v. van een brede tandlat wordt de tafel eenvoudig in de hoogte vasteld.
- Massieve, grote bodemplaat met T-gleuven.
- Ingewerkte machineverlichting
- Stalen handgreep uit drie stukken.
- Eenvoudigere gereedschapswissel door automatische booruitdrijver
- Gebruiksvriendelijke bedieningsknoppen met aparte start- en stopdrukknop en aparte noodstop.
- Degelijke boorafscherming uitgerust met veiligheidsschakelaar
- V-snaarkap uitgerust met veiligheidsschakelaar
- Alle modellen zijn links - rechtsdraaiend ook 230V modellen
- Digitale LED display voor de spilsnelheden (enkel op B28H Vario)
- Traploos regelbare spilsnelheden tot 5.600 tpm (enkel op B28H Vario)
- Gesloten koelvloeistofsysteem met koelpomp (enkel op B28H Vario)
- 3x220V model enkel mogelijk met transformator

Opmerking: 3x220V = krachtstroom (drijfkracht). Dit is niet hetzelfde als 1x230V mono = wisselstroom

Volledig gemonteerde machine

Order nr.		713020281 ^M	713020283 ^M	713020285 ^M
Orig. nr.		B28H 230V	B28H 400V	B28HV
Spanning	V	1x230	3x400	1x230
Vermogen motor	kW	0,850	0,850	1,5
Boorcapaciteit in staal S235JR	mm	28	28	28
Boorcapaciteit bij continu gebruik S235JR	mm	24	24	24
Spilopname	MK	3	3	3
Aantal snelheden		16	16	12 (traploos)
Spindeloriental	min-l	120-4000	120-4000	35-5600
Boordiepte	mm	105	105	105
Uitlading	mm	200	200	200
Diameter kolom	mm	92	92	92
Afmetingen tafel (b x d)	mm	340x360	340x360	340x360
T-gleuven	mm	14	14	14
Draaibaarheid boortafel	°	360	360	360
Afstand spindel-tafel	mm	860	860	860
Afstand spindel-voet	mm	1275	1275	1275
Afmetingen voet (b x d)	mm	320x320	320x320	320x320
T-gleuven voet	mm	14	14	14
Gewicht	kg	140,00	140,00	141,00
Afmetingen (l x b x h)	mm	698 x 449 x 1721	698 x 449 x 1721	701 x 474 x 1755
Prijs	€	1.339,00	1.359,00	2.490,00

B28H-B28H VARIO

MK3

ACCESSOIRES

p.1014-1091



- 7M Kwaliteitsriemen

- Aparte noodstop

- Links/rechts draaiend

- Rondloop nauwkeurigheid beter dan 0,015 mm

- Zware tussentafel met diagonaal patroon T-gleuven

0,85 KW



140kg

- Tot 4000 tpm

- Ingewerkte machineverlichting

- Booraafscherming met microscharelaar

- Aparte start / stopknop / noodstop

- Digitale weergave spijnsnelheden

- tot 5600 tpm

1,5 KW



VARIO

- Brede tandlat

- Kolom Ø 92 mm

- Met koelpomp

B28H

- T-gleuven in bodemplaat

B28H Vario

Standaard geleverd met :

- Optimum snelspan boorkop 1-16 mm B16
- Kegeldoorn volgens DIN228 MK3
- 2 T-moeren voor T-gleuf 14mm en draad M12.
- Nederlandstalige handleiding, opschriften, CE - kenmerk, en CE-attest volgens Machine richtlijn 2006/42/CE, Laagspanningsrichtlijn 2006/95/CE en EMC Richtlijn 2004/108/CE



Professionele kolomboormachine voor de betere werkplaats of opleidingscentra. B34H Vario. Met variabele, traploos regelbare spijlsnelheden tot 5.000 tpm

- Kolomboormachines met riemaandrijving.
 - Gegarandeerde rondlooptrouwkeurigheid van 0.015 mm gemeten in de boorspindel
 - Opname MK4.
 - Stille kwalitatieve elektromotoren.
 - Spil met precisie kogellagering.
 - Rustigere loop door aluminium riemschijven.
 - Door de getande kwaliteitsaandrijfriemen verkrijgt de machine een aanzienlijk betere krachtoverbrenging en beduidend minder prestatieverlies. 7M industriële V-riem, gegarandeerde levensduur van de riem tot 10.000 werkkuren.
 - Boordiepte aanslag.
 - Zware, precies bewerkte werktafel met T-gleuven in diagonaalpatroon en 360° draaibaar rond de kolom, voorzien van dubbele klemming. D.m.v. van een brede tandlat wordt de tafel eenvoudig in de hoogte vasteld.
 - Massieve, grote bodemplaat met T-gleuven.
 - Ingewerkte machineverlichting
 - Stalen handgreep uit drie stukken.
 - Eenvoudigere gereedschapswissel door automatische booruitdrijver
 - Gebruiksvriendelijke bedieningsknoppen met aparte start- en stopdrukknop en aparte noodstop.
 - Degelijke booraafscherming uitgerust met veiligheidsschakelaar
 - V-snaarkap uitgerust met veiligheidsschakelaar
 - Alle modellen zijn links - rechtsdraaiend ook 230V modellen
 - Digitale boordiepte instelling
 - Digitale LED display voor de spijlsnelheden
 - Traploos regelbare spijlsnelheden tot 5.000 tpm (enkel op B34H Vario)
 - Gesloten koelvloeistofsysteem met koelpomp (enkel op B34H Vario)
 - Keuzeschakelaar 4 standen (enkel op B34H Vario): - linksdraaiend - rechtdraaiend - Auto ON/OFF (automatisch spindel activatie bij het trekken aan de hendel en uitschakeling bij het loslaten) - tapfunctie (rechtsdraaiend tot op een bepaalde vooraf ingestelde diepte om vervolgens automatisch linksdraaiend terug te keren).
 - 3x220V model enkel mogelijk met transformator
- Opmerking: 3x220V = krachtstroom (drijfkracht). Dit is niet hetzelfde als 1x230V mono = wisselstroom

Volledig gemonteerde machine

Order nr.		713020333	713020335
Orig. nr.		B34H	B34HV
Spanning	V	3x400	1x230
Vermogen motor	kW	1,5 / 2,2	2,2
Boorcapaciteit in staal S235JR	mm	34	34
Spilopname	MK	4	4
Aantal snelheden		2x9	9 (vario)
Spindeltoerental	min-1	145-4800	40-5000
Boordiepte	mm	160	160
Uitlading	mm	285	285
Diameter kolom	mm	115	115
Afmetingen tafel (b x d)	mm	420x400	420x400
T-gleuven	mm	14	14
Draaibaarheid boortafel	°	360	360
Afstand spindel-tafel	mm	790	790
Afstand spindel-voet	mm	1025	1025
Afmetingen voet (b x d)	mm	390x370	390x390
T-gleuven voet	mm	16	16
Gewicht	kg	274,00	290,00
Afmetingen (l x b x h)	mm	918 x 585 x 1895	918 x 595 x 1930
Prijs	€	2.149,00	2.949,00

B34H-B34H VARIO



■ 7M Kwaliteitsriemen

MK4

ACCESSOIRES

p.1014-1091



2,2 KW

■ Digitale weergave spilsnelheden met digitale aflezing v/d snelheden

■ Digitale weergave dieptestelling

■ Ingebouwde machinelamp

■ Precisie spindel met omloopnauwkeurigheid van 0.015 mm

■ Grote werktafel met boorgat

■ Stevige, preciese tandlat



2,2 KW

VARIO

290kg

■ Stalen handgrepen

■ Vario 40-5000 min⁻¹

■ Brede tandlat



Automatische cyclus

Tapfunctie

Standaard geleverd met :

- Optimum snelspan boorkop 1-16 mm B16
- Kegeldoorn volgens DIN228 MK4
- 2 T-moeren voor T-gleuf 14mm en draad M12.
- Nederlandstalige handleiding, opschriften, CE - kenmerk, en CE-attest volgens Machine richtlijn 2006/42/CE, Laagspanningsrichtlijn 2006/95/CE en EMC Richtlijn 2004/108/CE

**OPTI**

Tafel- en kolomboormachines met traploos instelbare mechanische overbrenging.

- Tafel- en kolomboormachines met riemaandrijving.

- Duitse Vario mechanisch systeem

- Bruikbaar als werkoppervlak voor extra hoge werkstukken dankzij de draaibare boortafel

- Noodstop drukknop

- Rechts/links draairichting

- Eenvoudige gereedschapswissel door automatische uitdrijver (vanaf DH28BV)

- V-snaar deksel met veiligheidsschakelaar

- Digitale dieptemeter (DH34BV)

- Digitale snelheidsweergave

- Rustige loop en krachtige elektromotoren

- Draaibaarheid boortafel op 360°

- Rustigere loop dankzij aluminium riemschijven en getande snaren

- Opnames: MK2 (tafel) en MK3 / MK4 (kolom).

- Spil met precisie kogellagering.

- Rustigere loop door aluminium riemschijven.

- 7M industriële V-riem, gegarandeerde levensduur van de riem tot 10.000 werkuren.

- Zware, precies bewerkte werktafel met T-gleuven in diagonaalpatroon en 360° draaibaar rond de kolom, voorzien van dubbele klemming. D.m.v. van een brede tandlat wordt de tafel eenvoudig in de hoogte versteld.

- Massieve, grote bodemplaat met T-gleuven.

- Gebruiksvriendelijke bedieningsknopen met aparte start- en stopdrukknop en aparte noodstop.

- Degelijke boorafscherming uitgerust met veiligheidsschakelaar

- V-snaarkap uitgerust met veiligheidsschakelaar

- 3x220V model enkel mogelijk met transformator

Opmerking: 3x220V = krachtstroom (drijfkracht). Dit is niet hetzelfde als 1x230V mono = wisselstroom

Order nr.		713020420	713020430	713020440
Orig. nr.		DH24BV 400V	DH28BV 400V	DH34BV 400V
Spanning	V	400	400	400
Vermogen motor	kW	0,85/1,5	0,85/1,5	1,5/2,4
Boorcapaciteit in staal S235JR	mm	24	28	34
Boorcapaciteit bij continu gebruik S235JR	mm	20	24	26
Spilopname	MK	2	3	4
Aantal trappen		2	2	2
Spindeltoerental	min-1	300 - 4.000	300 - 4.000	300 - 4.000
Boordiepte	mm	85	105	160
Uitlading	mm	165	200	285
Afmetingen tafel (b x d)	mm	280x300	340x360	420x400
T-gleuven	mm	14	14	14
Afstand spindel-voet	mm	681	1275	1025
Afmetingen voet (b x d)	mm	280x260	320x320	390x390
Gewicht	kg	80,00	160,00	270,00
Afmetingen (l x b x h)	mm	665 x 434 x 1000	701 x 474 x 1780	918 x 595 x 1960
Prijs	€	1.790,00	2.100,00	2.790,00

DH24BV - DH28BV - DH34VBV VARIO



 Duits Vario
mechanisme systeem

NEW

ACCESSOIRES

p.1014-1091

MK3

■ Snelheidsregeling



DH28BV

■ Digitale snelheids weergave

■ Digitale boordiepte instelling

■ Machineverlichting

MK4

1,5/2,2 KW

280kg

VARIO

■ Kolomdiameter Ø 115

■ Grote werktafel 420 < 400mm

■ Massieve bodemplaat

MK2

0,85/1,5 KW

VARIO

■ Afscherming met microscharelaar



DH24BV

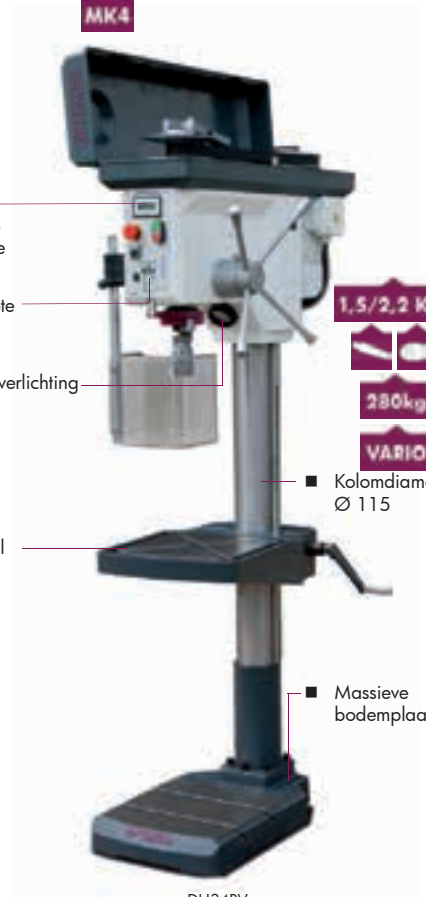

DH34BV

Standaard geleverd met :

- Optimum snelspan boorkop 1-16 mm B16
- Kegeldoorn volgens DIN228 MK2, respectievelijk MK3 en MK4
- 2 T-moeren voor T-gleuf 14mm en draad M12.
- Nederlandstalige handleiding, opschriften, CE - kenmerk, en CE-attest volgens Machine richtlijn 2006/42/CE, Laagspanningsrichtlijn 2006/95/CE en EMC Richtlijn 2004/108/CE



Krachtige kolomboormachine met variabele spilsnelheden voor professionals of opleidingscentra.

- Kolomboormachines met riemaandrijving.
 - Snelspanning systeem van de riemen door excenter
 - Opname MK3.
 - Stille kwalitatieve elektromotoren.
 - Spil met precisie kogellagering.
 - Rustigere loop door aluminium riemschijven.
 - Door de getande kwaliteitsaandrijfriemen verkrijgt de machine een aanzienlijk betere krachtoverbrenging en beduidend minder prestatieverlies. 7M industriële V-riem, gegarandeerde levensduur van de riem tot 10.000 werkkuren.
 - Boordiepte aanslag.
 - Zware, precies bewerkte werktafel met T-gleuven in diagonaalpatroon en 360° draaibaar rond de kolom, voorzien van dubbele klemming. D.m.v. van een brede tandlat wordt de tafel eenvoudig in de hoogte versteld.
 - Eenvoudigere gereedschapswissel door automatische booruitdrijver
 - Massieve, grote bodemplaat met T-gleuven.
 - Ingewerkte machineverlichting
 - Stalen handgreep uit drie stukken.
 - Gebruiksvriendelijke bedieningsknoppen met aparte start- en stopdrukknop en aparte noodstop.
 - Degelijke booraafscherming uitgerust met veiligheidsschakelaar
 - V-snaarkap uitgerust met veiligheidsschakelaar
 - Digitale boordiepte instelling, aflezing 0.01 mm, omschakelbaar tussen mm/inch
 - Digitale LED display voor de spilsnelheden
 - Traploos regelbare spilsnelheden tot 3.900 tpm
 - Gesloten koelvloeistofsysteem met koelpomp 40W
 - Keuzeschakelaar 4 standen: -linksdraaiend -rechtsdraaiend -Auto ON/OFF (automatisch spindel activatie bij het trekken aan de hendel en uitschakeling bij het loslaten) -tapfunctie (rechtsdraaiend tot op een bepaalde vooraf ingestelde diepte om vervolgens automatisch linksdraaiend terug te keren).
- Standaard geleverd met:
- Optimum snelspan boorkop 0-16 mm B16
 - Kegeldoorn volgens DIN228 MK3 B16
 - 2 T-moeren voor T-gleuf 14mm en draad M12.
 - Nederlandstalige handleiding, opschriften, CE - kenmerk, en CE-attest volgens Machine richtlijn 2006/42/CE, Laagspanningsrichtlijn 2006/95/CE en EMC Richtlijn 2004/108/CE

Order nr.		713021303
Orig. nr.		B30BS VARIO
Spanning	V	230
Vermogen motor	kW	2,2
Boorcapaciteit in staal S235JR	mm	30
Boorcapaciteit bij continu gebruik S235JR	mm	28
Spilopname	MK	3
Aantal snelheden		4 (traploos)
Spindeltoerental	min-1	30-3900
Boordiepte	mm	125
Uitlading	mm	285
Diameter kolom	mm	115
Afmetingen tafel (b x d)	mm	400x500
T-gleuven	mm	14
Draaibaarheid boortafel	°	360
Afstand spindel-tafel	mm	780
Afstand spindel-voet	mm	1230
Afmetingen voet (b x d)	mm	270x390
T-gleuven voet	mm	16
Gewicht	kg	280,00
Afmetingen (l x b x h)	mm	715 x 560 x 1850
Prijs	€	3.390,00

MK3

B30BS VARIO

- Kwalitatieve V-riemaandrijving 7m

ACCESSOIRES
p.1014-1091



- Digitale weergave spijlsnelheden



- Digitale weergave boordiepte instelling

- Traploos regelbaar toerental 4 gamma's tot 3900 tpm

- Verlichting

- Boorafscherm met microscharakelaar

- Grote werktafel 400x500 mm

- Dikwandige stalen kolom Ø 115 mm

- Geïntegreerde koelpomp

- Spanenfilter volgens machinerichtlijn

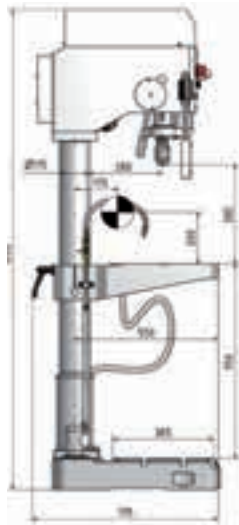

Standaard geleverd met :

- Optimum snelspan boorkop 0-16 mm B16
- Kegeldoorn volgens DIN228 MK3 B16
- 2 T-moeren voor T-gleuf 14mm en draad M12.
- Nederlandstalige handleiding, opschriften, CE - kenmerk, en CE-attest volgens Machine richtlijn 2006/42/CE, Laagspanningsrichtlijn 2006/95/CE en EMC Richtlijn 2004/108/CE

Tandwielangedreven kolomboormachines

OPTI

Krachtige, evolutionaire kolomboormachine met variabele spijlsnelheden en elektromagnetische voeding.

- Kolomboormachines met tandwieloverbrenging.
- Elektromagnetische voeding, door een eenvoudige druk op één van de knoppen in de handgreep wordt de automatische voeding in- en uitgeschakeld.
- 3 voedingen aanwezig (St.37) : 0,1 mm/omw. tot ø 30 mm 0,15 mm/omw. tot ø 24 mm 0,2 mm/omw. tot ø 20 mm
- Opname MK3.
- Stille kwalitatieve elektromotoren.
- Spil met precisie kogellagering.
- Hoge rondloopnauwkeurigheid door geharde en geslepen hoofdspindel.
- Tandwieloverbrenging wordt gesmeerd in een oliebad. Alle tandwielen en assen zijn geslepen en gehard.
- Zware, precies bewerkte werktafel met T-gleuven in diagonaalpatroon en 360° draaibaar rond de kolom, voorzien van dubbele klemming. D.m.v. van een brede tandlat wordt de tafel eenvoudig in de hoogte versteld.
- Eenvoudigere gereedschapswissel door automatische booruitdrijver
- Massieve, grote bodemplaat met T-gleuven.
- Ingewerkte halogeen machineverlichting 12V
- Stalen handgreep uit drie stukken met afzonderlijke voeding activatie drukknoppen.
- Gebruiksvriendelijke bedieningsknoppen met aparte start- en stopdrukknop en aparte noodstop.
- Degelijke boorafscherming uitgerust met veiligheidsschakelaar
- Digitale boordiepte instelling, aflezing 0.01 mm, omschakelbaar tussen mm/inch
- Digitale LED display voor de spijlsnelheden
- Traploos regelbare spijlsnelheden tot 3.000 tpm
- Gesloten koelvloeistofsysteem met koelpomp 40W
- Keuzeschakelaar 4 standen: linksdraaiend rechtdraaiend Auto ON/OFF (automatisch spindel activatie bij het trekken aan de hendel en uitschakeling bij het loslaten) tapfunctie (rechtsdraaiend tot op een bepaalde vooraf ingestelde diepte om vervolgens automatisch linksdraaiend terug te keren).
- Combinatie riemaandrijving / tandwieloverbrenging
- Tandwielgamma - Spindeltoerentallen - Draaimoment
- Gemakkelijke werktuigwissel door geïntegreerde booruitwerper.

Order nr.	713034303 	
Orig. nr.	B30VGM	
Spanning	V	1x230
Vermogen motor	kW	2,5
Boorcapaciteit in staal S235JR	mm	30
Boorcapaciteit bij continu gebruik S235JR	mm	24
Spilopname	MK	3
Uitlading	mm	285
Aantal snelheden	3 (traploos)	
Spindeltoerental	min-1	80-700/28Nm · 170-1500/28Nm · 400-3000/7Nm
Boordiepte	mm	125
Diameter kolom	mm	115
Afstand spindel-tafel	mm	780
Afmetingen tafel (b x d)	mm	400x500
T-gleuven	mm	14
Draaibaarheid boortafel	°	360
Afstand spindel-voet	mm	1320
Afmetingen voet (b x d)	mm	385x385
T-gleuven voet	mm	16
Gewicht	kg	292,00
Afmetingen (l x b x h)	mm	860 x 600 x 2100
Prijs	€	3.990,00

MK3

B30VGM

ACCESSOIRES

p.1014-1091

■ Krachtige motor 2,5 kW

■ Digitale weergave spijlsnelheden

■ Digitale weergave boordiepteinstelling

■ Boorafscherming met microscharlaar

■ Geïntegreerde koelpomp

■ Tandwielen in oliebad gesmeerd

■ Elektromagnetische voeding

VARIO



■ Verlichting

■ Grote tussentafel 400x500 mm

■ Dikwandige stalen kolom Ø 115 mm

■ Spanenfilter volgens machinerichtlijn

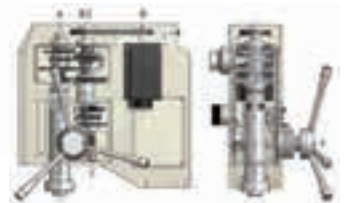

Standaard geleverd met :

- Optimum snelspan boorkop 0-16 mm B16
- Kegeldoorn volgens DIN228 MK3 B16
- 2 T-moeren voor T-gleuf 14mm en draad M12.
- Nederlandstalige handleiding, opschriften, CE - kenmerk, en CE-attest volgens Machine richtlijn 2006/42/CE, Laagspanningsrichtlijn 2006/95/CE en EMC Richtlijn 2004/108/CE

OPTI

Tandwiel aangedreven tafelboormachine voor montagebedrijven en de algemene industrie.

- Tafelboormachine met tandwiel overbrenging.
- Opname MK3.
- Krachthige, stille 2 stappen motoren.
- Spil met precisie kogellagering.
- Precieze omloopnauwkeurigheid spindel en een lange levensduur door helicoïdale tandwielen uit staal en versterkt fiber materiaal.
- Stabiliteit gegarandeerd door een zwaar gedimensioneerde, dikwandige stalen kolom \varnothing 100 mm
- Rechts / links draairichting
- Groot gedimensioneerde gietijzeren werktafel, geslepen en voorzien van T-gleuven
- Massieve, grote bodemplaat met T-gleuven.
- In de hoogte verstelbare en verdraaibare boorkop via degelijke tandlat en voorzien van sterke klemming.
- Boordiepte instelling met millimeter schaal.
- Snelheidsinstelling door twee schakelhendels aan de zijkant van de boorkop
- Degelijke boorafscherming met microschakelaar, boormachine valt onmiddellijk stil bij het openen van de afscherming
- Gebruiksvriendelijke bedieningsknoppen met aparte start- en stopdrukknop en aparte noodstop.
- Andere voltages: 3x220V en 3x440V op aanvraag.

Opgepast: snelspan boorkop en kegeldoorn zijn NIET inbegrepen

Order nr.	713034260 M	
Orig. nr.		B26GT
Spanning	V	3x400
Vermogen motor	kW	0,65 / 1,2
Boorcapaciteit in staal S235JR	mm	26
Boorcapaciteit bij continu gebruik S235JR	mm	21
Spilopname	MK	3
Uitlading	mm	255
Aantal snelheden		8
Spindeltoerental	min-1	105-2900
Boordiepte	mm	125
Diameter kolom	mm	100
Afmetingen voet (b x d)	mm	570x340
T-gleuven voet	mm	14
Gewicht	kg	192,00
Afmetingen (l x b x h)	mm	570 x 550 x 880
Prijs	€	1.749,00



B26GT

ACCESSOIRES
p.1014-1091

- Keuzehendels spilsnelheden tot 2900tpM
- Aparte noodstop
- Boorafscherming met microschakelaar
 - Optie
- Kolomdiameter Ø 100mm
- Tandwieloverbrenging in vet
- Boorkop in hoogte verstelbaar
- Massieve bodemplaat

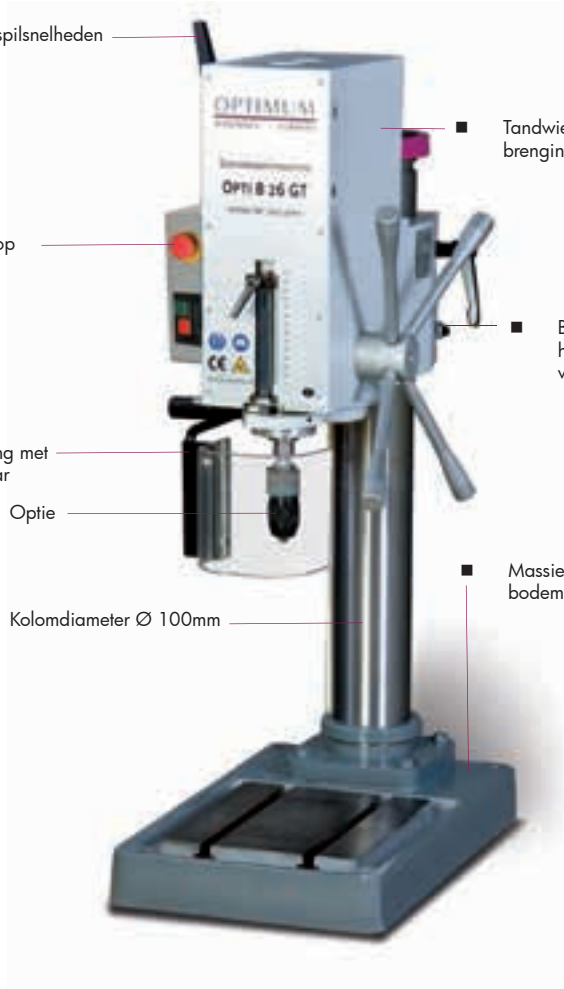

Standaard geleverd met :

- Nederlandstalige handleiding, opschriften, CE - kenmerk, en CE-attest volgens Machine richtlijn 2006/42/CE, Laagspanningsrichtlijn 2006/95/CE en EMC Richtlijn 2004/108/CE

**OPTIE**

Tandwiel aangedreven kolomboormachine voor montagebedrijven en de algemene industrie.

- Kolomboormachine met tandwiel overbrenging.
- Opname MK3.
- Krachtige, stille 2 stappen motoren.
- Spil met precisie kogellagering.
- Precieze omloopnauwkeurigheid spindel en een lange levensduur door helicoïdale tandwielen uit staal en versterkt fiber materiaal.
- Stabiliteit gegarandeerd door een zwaar gedimensioneerde, dikwandige stalen kolom \varnothing 100 mm
- Rechts / links draairichting
- Groot gedimensioneerde gietijzeren werktafel, geslepen en voorzien van T-gleuven
- Massieve, grote bodemplaat met T-gleuven.
- In de hoogte verstelbare en verdraaibare boorkop via degelijke tandlat en voorzien van sterke klemming.
- Boordiepte instelling met millimeter schaal.
- Snelheidsinstelling door twee schakelhendels aan de zijkant van de boorkop
- Degelijke boorafscherming met microscharnelaar, boormachine valt onmiddellijk stil bij het openen van de afscherming
- Gebruiksvriendelijke bedieningsknopen met aparte start- en stopdrukknop en aparte noodstop.
- Andere voltages: 3x220V en 3x440V op aanvraag.

Opgepast: snelspan boorkop en kegeldoorn zijn NIET inbegrepen

Order nr.	713034270 M	
Orig. nr.		B26GS
Spanning	V	3x400
Vermogen motor	kW	0,65 / 1,2
Boorcapaciteit in staal S235JR	mm	26
Boorcapaciteit bij continu gebruik S235JR	mm	21
Spilopname	MK	3
Uitlading	mm	255
Aantal snelheden		8
Spindeltoerental	min-1	105-2900
Boordiepte	mm	125
Diameter kolom	mm	100
Afstand spindel-tafel	mm	840
Afmetingen tafel (b x d)	mm	500x350
T-gleuven	mm	14
Draaibaarheid boortafel	°	360
Afstand spindel-voet	mm	1230
Afmetingen voet (b x d)	mm	570x340
T-gleuven voet	mm	14
Gewicht	kg	220,00
Afmetingen (l x b x h)	mm	580 x 580 x 1590
Prijs	€	1.889,00

-
- Tot 2900 tpm
 - Aparte noodstop
 - Boorkop in hoogte verstelbaar
 - Stalen handgrepen
 - Boorafscherming met microscharnelaar
 - Groot gedimensioneerde werktafel 500x350mm
 - Kolomdiameter Ø 100mm
 - Bodemplaat met T-gleuven

Standaard geleverd met :

- Nederlandstalige handleiding, opschriften, CE - kenmerk, en CE-attest volgens Machine richtlijn 2006/42/CE, Laagspanningsrichtlijn 2006/95/CE en EMC Richtlijn 2004/108/CE



Tandwiel aangedreven tafelboormachine voor montagebedrijven en de algemene industrie.

- Tafelboormachine met tandwiel overbrenging.
- Zware, massieve gietijzeren uitvoering
- Onderhoudsarme aandrijving met vetsmering.
- Opname MK3.
- Krachtige, stille 2 stappen motor.
- Geluidsarme loop dankzij geslepen meenemer met multivertanding.
- Precieze omloopnauwkeurigheid spindel en een lange levensduur door geharde en geslepen spindel.
- Gietijzeren dikwandige kolom voor grote krachtopnames en stabiliteit
- Rechts / links draairichting
- Groot gedimensioneerde gietijzeren werktafel, geslepen en voorzien van T-gleuven
- Massieve, grote bodemplaat met T-gleuven.
- Boordiepte instelling met millimeter schaal.
- Snelheidsinstelling door twee keuzeschakelaars aan de linker zijkant van de boorkop
- Degelijke boorafscherming met microschakelaar, boormachine valt onmiddellijk stil bij het openen van de afscherming
- Gebruiksvriendelijke bedieningsknoppen met aparte start- en stopdrukknop en aparte noodstop.
- Andere voltages: 3x220V en 3x440V op aanvraag.

Opgepast: snelspan boorkop is NIET inbegrepen

Order nr.	713034220 	
Orig. nr.		DH26GT
Spanning	V	3x400
Vermogen motor	kW	1.1/1.5
Boorcapaciteit in staal S235JR	mm	26
Boorcapaciteit bij continu gebruik S235JR	mm	24
Spilopname	MK	3
Uitlading	mm	235
Aantal snelheden		8
Spindeltoerental	min-1	75-2900
Boordiepte	mm	127
Diameter kolom	mm	92
Afstand spindel-tafel	mm	450
Afmetingen tafel (b x d)	mm	380x380
T-gleuven	mm	14
Draaibaarheid boortafel	°	360
Maximum belastbaar gewicht	kg	250
Afstand spindel-voet	mm	610
Afmetingen voet (b x d)	mm	350x322
T-gleuven voet	mm	14
Gewicht	kg	166,00
Afmetingen (l x b x h)	mm	1600 x 500 x 700
Prijs	€	1.695,00

MK3 DH 26GT

NEW 166kg 1,1/1,5 KW

**ACCESSOIRES
p.1014-1091**

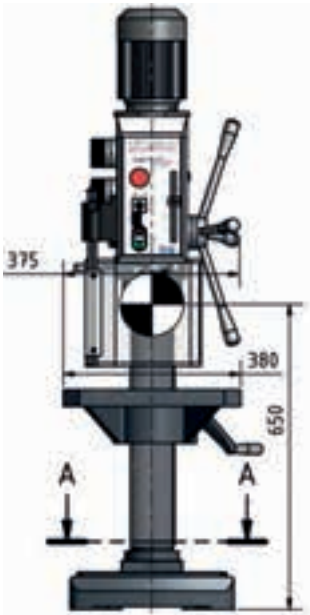

- Aparte noodstop
- Links/rechts draaiend
- Optionele boorkop
- Afscherming met microscharrelaar



- Krachtige, stille 2 stappen motor
- 4-voudige ergonomisch spaakwiel
- Tandwiel overbrenging
- Gietijzeren dikwandige kolom
- Groot gedimensioneerde werktafel over landtlat



- 8 snelheden 75-2900

Standaard geleverd met :

- Kegeldoorn MK3 - B16
- Nederlandstalige handleiding, opschriften, CE - kenmerk, en CE-attest volgens Machine richtlijn 2006/42/CE, Laagspanningsrichtlijn 2006/95/CE en EMC Richtlijn 2004/108/CE



Tandwiel aangedreven kolomboormachine voor montagebedrijven en de algemene industrie.

- Kolomboormachine met tandwiel overbrenging.
- Zware, massieve gietijzeren uitvoering
- Onderhoudsarme aandrijving met vetsmering.
- Opname MK3.
- Krachtige, stille 2 stappen motor.
- Geluidsarme loop dankzij geslepen meenemer met multivertanding.
- Precieze omloopnauwkeurigheid spindel en een lange levensduur door geharde en geslepen spindel.
- Gietijzeren dikwandige kolom voor grote krachtopnames en stabiliteit
- Rechts / links draairichting
- Groot gedimensioneerde gietijzeren werktafel, geslepen en voorzien van T-gleuven
- Massieve, grote bodemplaat met T-gleuven.
- Boordiepte instelling met millimeter schaal.
- Snelheidsinstelling door twee keuzeschakelaars aan de linker zijkant van de boorkop
- Degelijke boorafscherming met microschatelaar, boormachine valt onmiddellijk stil bij het openen van de afscherming
- Gebruiksvriendelijke bedieningsknoppen met aparte start- en stopdrukknop en aparte noodstop.
- Andere voltages: 3x220V en 3x440V op aanvraag.

Opgepast: snelspan boorkop is NIET inbegrepen

Order nr.	713034230 ^M	
Orig. nr.		DH28GS
Spanning	V	3x400
Vermogen motor	kW	1.1/1.5
Boorcapaciteit in staal S235JR	mm	28
Boorcapaciteit bij continu gebruik S235JR	mm	25
Spilopname	MK	3
Uitlading	mm	260
Aantal snelheden		8
Spindeltoerental	min-1	75-2900
Boordiepte	mm	127
Diameter kolom	mm	92
Afstand spindel-tafel	mm	875
Afmetingen tafel (b x d)	mm	376x394
T-gleuven	mm	14
Draaibaarheid boortafel	°	360
Maximum belastbaar gewicht	kg	250
Afstand spindel-voet	mm	1200
Afmetingen voet (b x d)	mm	350x356
T-gleuven voet	mm	14
Gewicht	kg	184,00
Afmetingen (l x b x h)	mm	670 x 550 x 2080
Prijs	€	2.149,00



NEW

1,1/1,5 KW

184kg

ACCESSOIRES

p.1014-1091

- Krachtige, stille 2 stappen motor
- 4-voudige ergonomisch spaakwiel
- Machineverlichting
- Gietijzeren dikwandige kolom
- Groot gedimensioneerde werktafel over tandlat
- Massieve bodemplaat
- Aparte noodstop
- Links/rechts draaiend
- Optionele boorkop
- Afscherming met microscharrelaar

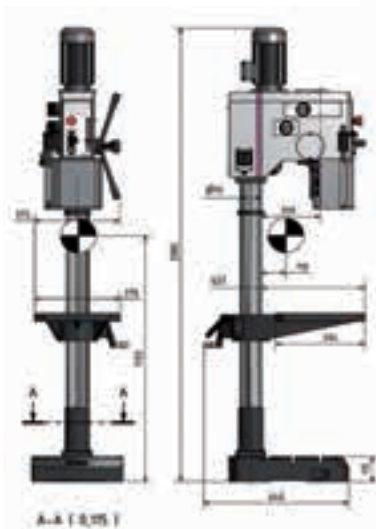

■ 8 snelheden 75-2900

Standaard geleverd met :

- Kegeldoorn MK3 - B16
- Nederlandstalige handleiding, opschriften, CE - kenmerk, en CE-attest volgens Machine richtlijn 2006/42/CE, Laagspanningsrichtlijn 2006/95/CE en EMC Richtlijn 2004/108/CE

MACHINES



OPTIMUM

Tandwiel aangedreven kolomboormachine met elektromagnetische voeding, tapfunctie en koelsysteem.

- Kolomboormachine met tandwiel overbrenging.
- Elektromagnetische boorvoeding, met 3 voedingen 0.1, 0.15 en 0.20 mm/omw.
- Gesloten koelvloeistofsysteem met koelpomp en spanenfilter volgens de machine richtlijn.
- Geïntegreerde machineverlichting in de boorkop
- Zware, massieve gietijzeren uitvoering
- Onderhoudsarme aandrijving met vetsmering.
- Opname MK4.
- Krachtige, stille 2 stappen motor.
- Geluidsarme loop dankzij geslepen meenemer met multivertanding.
- Precieze omloopnauwkeurigheid spindel en een lange levensduur door geharde en geslepen spindel.
- Gietijzeren dikwandige kolom voor grote krachtopnames en stabiliteit
- Rechts / links draairichting
- Groot gedimensioneerde gietijzeren werktafel, geslepen en voorzien van T-gleuven
- Massieve, grote bodemplaat met T-gleuven.
- Boordiepte instelling met millimeter schaal.
- Snelheidsinstelling door twee keuzeschakelaars aan de linker zijkant van de boorkop
- Degelijke boorafscherming met microschatelaar, boormachine valt onmiddellijk stil bij het openen van de afscherming
- Gebruiksvriendelijke bedieningsknoppen met aparte start- en stopdrukknop en aparte noodstop.
- Andere voltages: 3x220V en 3x440V op aanvraag.

Opgepast: snelspan boorkop is NIET inbegrepen

Order nr.	713034240	
Orig. nr.		DH32GS
Spanning	V	3x400
Vermogen motor	kW	1.5/2.2
Boorcapaciteit in staal S235JR	mm	32
Boorcapaciteit bij continu gebruik S235JR	mm	29
Spilopname	MK	4
Uitlading	mm	285
Aantal snelheden		8
Spindeltoerental	min-1	75-2000
Boordiepte	mm	125
Aantal boorvoedingen		3
Automatische boorvoedingen	mm	0,10-0,15-0,20
Diameter kolom	mm	115
Afstand spindel-tafel	mm	820
Afmetingen tafel (b x d)	mm	400x420
T-gleuven	mm	14
Draaibaarheid boortafel	°	360
Maximum belastbaar gewicht	kg	250
Afstand spindel-voet	mm	1280
Afmetingen voet (b x d)	mm	420x644
T-gleuven voet	mm	14
Gewicht	kg	295,00
Afmetingen (l x b x h)	mm	725 x 450 x 2200
Prijs	€	2.690,00



3 boorvoedingen
Geïntegreerde booruitwerper

NEW

1,5/2,2 KW 295kg

ACCESSOIRES
p.1014-1091

- Aparte noodstop
- Links/rechts draaiend
- Optionele boorkop
- Afscherming met microschemelaar
- Krachtige, stille 2 stappen motor
- 4-voudige ergonomisch spaakwiel
- Electromagnetische voeding
- Gietijzeren dikwandige kolom
- Groot gedimensioneerde werktafel over tandlat
- Gesloten koelvloeistof systeem met pomp
- Spanenfilter volgens machinerichtlijn

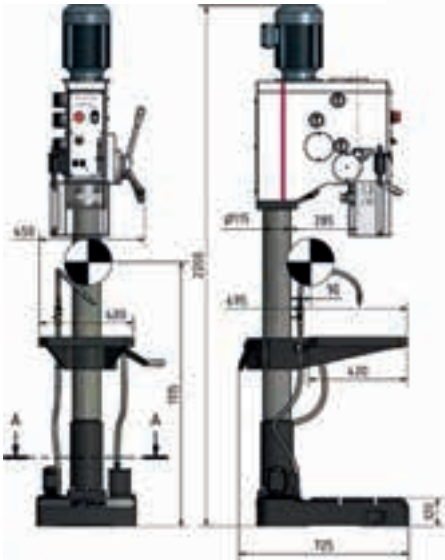

■ 8 snelheden 75-2900

Standaard geleverd met :

- Kegeldoorn MK4 - B16
- Nederlandstalige handleiding, opschriften, CE - kenmerk, en CE-attest volgens Machine richtlijn 2006/42/CE, Laagspanningsrichtlijn 2006/95/CE en EMC Richtlijn 2004/108/CE



Tandwiel aangedreven tafelboormachine voor montagebedrijven en de algemene industrie, **waar ook mee gefreesd kan worden.**

- Tafelboormachine met tandwiel overbrenging.
- Opname MK3 met aantrekdraad M12.
- Krachtige, stille 2 stappen motoren.
- Spil met precisie kogellagering.
- Precieze omloopnauwkeurigheid spindel.
- Stabiliteit gegarandeerd door een zwaar gedimensioneerde, dikwandige stalen kolom \varnothing 115 mm
- Rechts / links draairichting
- Hoogteverstelling werktafel via tandlat
- Massieve, grote bodemplaat met T-gleuven.
- In de hoogte verstelbare en verdraaibare boorkop via degelijke tandlat en voorzien van sterke klemming.
- Boorkop is eveneens links en rechts instelbaar tot 60°
- Boordiepte instelling met millimeter schaal.
- Stalen handgreep uit drie stukken.
- Handwiel voor fijne manuele voeding
- Snelheidsinstelling door twee schakelhendels aan de voorkant van de boorkop
- Degelijke boorafscherming met microschakelaar, boormachine valt onmiddellijk stil bij het openen van de afscherming
- Gebruiksvriendelijke bedieningsknopen met aparte start- en stopdrukknop en aparte noodstop.
- Andere voltages: 3x220V en 3x440V op aanvraag

Order nr.	713034335 	
Orig. nr.		B40BE
Spanning	V	3x400
Vermogen motor	kW	1,1-1,5
Boorcapaciteit in staal S235JR	mm	32
Boorcapaciteit bij continu gebruik S235JR	mm	25
Spilopname	MK	3/M12
Uitlading	mm	288
Aantal snelheden		12
Spindeltoerental	min-1	95-3200
Boordiepte	mm	120
Diameter kolom	mm	115
Afstand spindel-voet	mm	550
Afmetingen voet (b x d)	mm	410x625
T-gleuven voet	mm	16
Gewicht	kg	341,00
Afmetingen (l x b x h)	mm	700 x 650 x 1400
Prijs	€	1.890,00

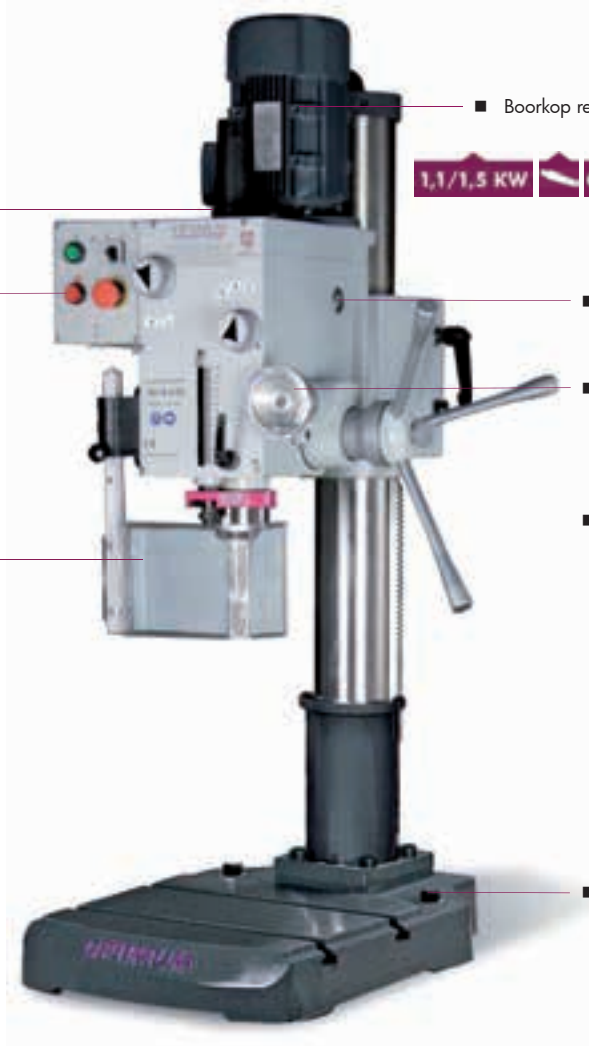

- Boorkop regelbaar in de hoogte
- Met aantrekstang voor freesbewerkingen
- Aparte noodstop
- Booraafscherming met microscharnelaar
- 1,1/1,5 KW
- ACCESSOIRES p.1014-1091
- Oliepeilglas
- Fijne voeding
- Stalen spaakwiel
- Massieve bodemplaat

■ Smering in oliebad



■ Bediening vooraan



■ Schuinstelbare boor(frees)kop

Standaard geleverd met :

- Tandkrans boorkop 1-16 mm B16
- Kegeldoorn MK3/M12/B16
- Nederlandstalige handleiding, opschriften, CE - kenmerk, en CE-attest volgens Machine richtlijn 2006/42/CE, Laagspanningsrichtlijn 2006/95/CE en EMC Richtlijn 2004/108/CE



OPTIQ

Tandwiel aangedreven kolomboormachine voor montagebedrijven en de algemene industrie, **waar ook mee gefreesd kan worden.**

- Kolomboormachine met tandwiel overbrenging.
- Opname MK4 met aantrekdraad M16.
- Krachtige, stille 2 stappen motoren.
- Spil met precisie kogellagering.
- Precieze omloopnauwkeurigheid spindel.
- Stabiliteit gegarandeerd door een zwaar gedimensioneerde, dikwandige stalen kolom \varnothing 115 mm
- Rechts / links draairichting
- Groot gedimensioneerde gietijzeren werktafel, geslepen en voorzien van T-gleuven.
- Hoogteverstelling werktafel via tandlat
- Massieve, grote bodemplaat met T-gleuven.
- In de hoogte verstelbare en verdraaibare boorkop via degelijke tandlat en voorzien van sterke klemming.
- Boorkop is eveneens links en rechts instelbaar tot 60°
- Boordiepte instelling met millimeter schaal.
- Stalen handgreep uit drie stukken.
- Handwiel voor fijne manuele voeding
- Snelheidsinstelling door twee schakelhendels aan de voorkant van de boorkop
- Degelijke boorafscherming met microscharnelaar, boormachine valt onmiddellijk stil bij het openen van de afscherming
- Gebruiksvriendelijke bedieningsknoppen met aparte start- en stopdrukknop en aparte noodstop.
- Gesloten koelvloeistofsysteem met koelpomp 40W
- Andere voltages: 3x220V en 3x440V op aanvraag

Order nr.	713034340	
Orig. nr.		B40E
Spanning	V	3x400
Vermogen motor	kW	1,1-1,5
Boorcapaciteit in staal S235JR	mm	32
Boorcapaciteit bij continu gebruik S235JR	mm	25
Spilopname	MK	4/M16
Uitlading	mm	285
Aantal snelheden		12
Spindeltoerental	min-1	95-3200
Boordiepte	mm	120
Diameter kolom	mm	115
Afstand spindel-tafel	mm	855
Afmetingen tafel (b x d)	mm	425x420
T-gleuven	mm	14
Draaibaarheid boortafel	°	360
Afstand spindel-voet	mm	1215
Afmetingen voet (b x d)	mm	385x385
T-gleuven voet	mm	16
Gewicht	kg	322,00
Afmetingen (l x b x h)	mm	700 x 600 x 2050
Prijs	€	2.790,00

MK4/M16

B40E

1,1/1,5 KW

ACCESSOIRES

p.1014-1091

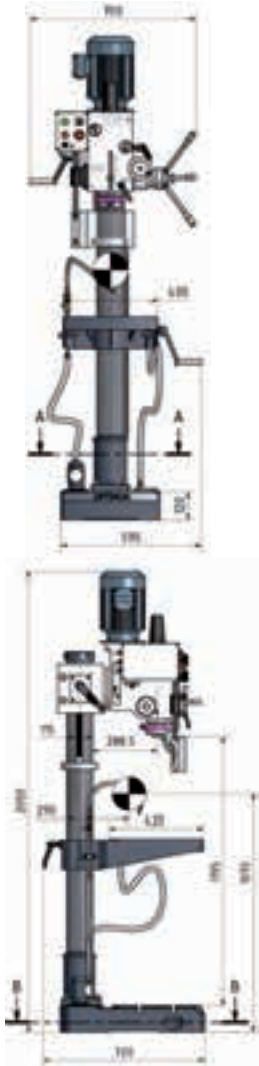

- Met aantrekgang voor freesbewegingen
- Aparte noodstop
- In de hoogte verstelbare boor(frees)kop
- Oliepeilglas
- 180° zwenkbare boorkop
- Dikwandige gietijzeren kolom Ø 115
- Boorafscherming met microscharnelaar
- Gesloten koelvloeistof systeem met koelpomp
- Spanenfilter volgens machinerichtlijn

- Smering in oliebad



- Boorkop links-rechts instelbaar 90°

- Bediening vooraan



Standaard geleverd met :

- Tandkrans boorkop 1-16 mm B16
- Kegeldoorn MK4/M16 B16
- Nederlandstalige handleiding, opschriften, CE - kenmerk, en CE-attest volgens Machine richtlijn 2006/42/CE, Laagspanningsrichtlijn 2006/95/CE en EMC Richtlijn 2004/108/CE



Tandwiel aangedreven kolomboormachine voor montagebedrijven en de algemene industrie.

- Kolomboormachine met tandwiel overbrenging.
- Mechanische automatische voeding
- 3 voedingen aanwezig (St.37) : 0,1 / 0,18 / 0,26 mm/omw
- Opname MK4 met aantrekdraad M16.
- Krachtige, stille 2 stappen motoren.
- Spil met precisie kogellagering.
- Precieze omloopnauwkeurigheid spindel.
- Stabiliteit gegarandeerd door een zwaar gedimensioneerde, dikwandige stalen kolom ø 115 mm - Rechts / links draairichting
- Groot gedimensioneerde gietijzeren werktafel, geslepen en voorzien van T-gleuven. Bovendien is de werktafel zwenkbaar onder hoek.
- Hoogteverstelling werktafel via tandlat
- Massieve, grote bodemplaat met T-gleuven.
- In de hoogte verstelbare en verdraaibare boorkop via degelijke tandlat en voorzien van sterke klemming.
- Boorkop is eveneens links en rechts instelbaar tot 60°
- Boordiepte instelling met millimeter schaal.
- Handwiel voor fijne manuele voeding
- Snelheidsinstelling door twee schakelhendels aan de voorkant van de boorkop - Degelijke boorafscherming met microscharnelaar, boormachine valt onmiddellijk stil bij het openen van de afscherming
- Gebruiksvriendelijke bedieningsknoppen met aparte start- en stopdrukknop en aparte noodstop.
- Gesloten koelvloeistofstelsysteem met koelpomp 40W
- Andere voltages: 3x220V en 3x440V op aanvraag

Order nr.		713034345
Orig. nr.		B40PTE
Spanning	V	3x400
Vermogen motor	kW	1,1-1,5
Boorcapaciteit in staal S235JR	mm	32
Boorcapaciteit bij continu gebruik S235JR	mm	25
Spilopname	MK	4/M16
Uitlading	mm	285
Aantal snelheden		12
Spindeltoerental	min-1	95-3200
Boordiepte	mm	120
Diameter kolom	mm	115
Afstand spindel-tafel	mm	855
Afmetingen tafel (b x d)	mm	400x445
T-gleuven	mm	14
Zwenkbaarheid boortafel	°	360
Draaibaarheid boortafel	°	360
Afstand spindel-voet	mm	1215
Afmetingen voet (b x d)	mm	385x385
T-gleuven voet	mm	16
Gewicht	kg	322,00
Afmetingen (l x b x h)	mm	720 x 700 x 2050
Prijs	€	3.090,00

MK4/M16

B40PTE

1,1/1,5 KW



ACCESSOIRES

p.1014-1091

- Met aantrekstang voor freesbewerkingen
- Aparte noodstop
- Boorafscherming met microscharnelaar
- Zwenkbare draaitafel 360° (400 x 445mm)
- Standaard koelpomp
- In de hoogte verstelbare boor(frees)kop
- Oliepeilglas
- 3 automatische boorvoedingen
- Fijne boorvoeding
- Dikwandige stalen kolom
- Spanenfilter volgens machinerichtlijn
- Bediening vooraan

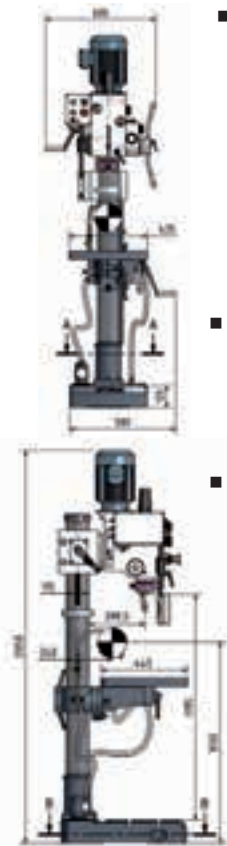

- Smering in oliebad



- Boorkop links-rechts instelbaar 90°



Standaard geleverd met :

- Tandkrans boorkop 1-16 mm B16
- Kegeldoorn MK4/M16 B16
- Nederlandstalige handleiding, opschriften, CE - kenmerk, en CE-attest volgens Machine richtlijn 2006/42/CE, Laagspanningsrichtlijn 2006/95/CE en EMC Richtlijn 2004/108/CE

OPTI

Zware industriële kolomboormachines met tandwiel overbrenging en automatische mechanische voeding.

- Kolomboormachines met tandwieloverbrenging.
- Mechanische voeding, door het activeren van de voedingshendel, wordt na het bereiken van de vooraf ingestelde boordiepte, de voedingshendel mechanisch terug gedrukt door de boordiepte aanslag en wordt de automatische voeding gedeactiveerd.
- 2 voedingen aanwezig (St.37) : 0,1 mm/omw. 0,2 mm/omw.
- Opname MK4.
- Stille kwalitatieve elektromotoren.
- Grote uitlading van 350 mm, waardoor grotere stukken kunnen worden bewerkt.
- Spil met precisie kogellagering.
- Hoge rondlooppauwkeurigheid door geharde en geslepen hoofdspindel.
- Tandwieloverbrenging wordt gesmeerd in een oliebad. Alle tandwielen en assen zijn geslepen en gehard.
- Zware, precies bewerkte werktafel met T-gleuven in diagonaalpatroon en 360° draaibaar rond de kolom, voorzien van dubbele klemming. D.m.v. van een brede tandlat wordt de tafel eenvoudig in de hoogte versteld.
- Eenvoudigere gereedschapswissel door automatische booruitdrijver
- Massieve, grote bodemplaat met T-gleuven.
- Ingewerkte halogeen machineverlichting 12V
- Gebruiksvriendelijke bedieningsknoppen met aparte start- en stopdrukknop en aparte noodstop.
- Degelijke boorafscherming uitgerust met veiligheidsschakelaar
- Gesloten koelvloeistofsysteem met koelpomp 40W
- Tapfunctie (rechtsdraaiend tot op een bepaalde vooraf ingestelde diepte om vervolgens automatisch linksdraaiend terug te keren).
- Keuzeschakelaar twee snelheden
- Links- en rechtsdraaiend
- Spil oriëntatieknop voor precieze centrering
- Ook verkrijgbaar in andere voltages: 713334407 - 3x220V/50Hz en 713334404 - 3x440V/60Hz.

Voor actuele prijzen raadpleeg onze binnendienst.

Opmerking: 3x220V = krachtstroom (drijfkracht). Dit is niet hetzelfde als 1x230V mono = wisselstroom

Order nr.	713334403 	
Orig. nr.		B40GSP
Spanning	V	3x400
Vermogen motor	kW	1,5
Boorcapaciteit in staal S235JR	mm	35
Boorcapaciteit bij continu gebruik S235JR	mm	35
Draadsnijcapaciteit in staal S235JR	M	24
Spilopname	MK	4
Uitlading	mm	350
Aantal snelheden		18
Spindeltoerental	min-1	50-1450
Boordiepte	mm	180
Diameter kolom	mm	150
Afstand spindel-tafel	mm	780
Afmetingen tafel (b x d)	mm	560x560
T-gleuven	mm	18
Draaibaarheid boortafel	°	360
Afstand spindel-voet	mm	1320
Afmetingen voet (b x d)	mm	510x500
T-gleuven voet	mm	18
Gewicht	kg	500,00
Afmetingen (l x b x h)	mm	935 x 560 x 2280
Prijs	€	3.990,00

MK4 B40GSP

1,5 KW

ACCESSOIRES

p.1014-1091

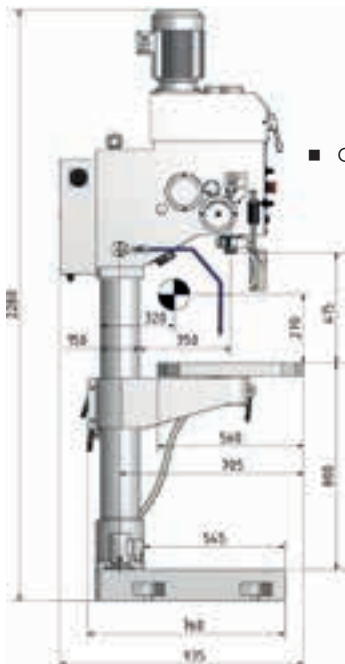
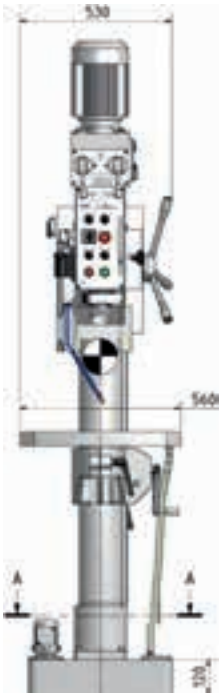

- Snelheidshendels vooraan
- Tapfunctie
- Jogfunctie
- Boorafscherming met microscharlaar
- Zware gietijzeren tussentafel 560 x 560
- Geïntegreerde koelpomp
- Tandwielen constant gesmeerd in oliebad
- Boordiepte aanslag met mm schaal
- Mechanische voeding
- Verlichting
- Kolom Ø 150 mm
- Spanenfilter volgens machinerichtlijn
- Massieve bodemplaat

Standaard geleverd met :

- Optimum snelspan boorkop 0-16 mm B16
- Kegeldoorn volgens DIN228 MK4 B16
- 2 T-moeren voor T-gleuf 18mm en draad M16.
- Nederlandstalige handleiding, opschriften, CE - kenmerk, en CE-attest volgens Machine richtlijn 2006/42/CE, Laagspanningsrichtlijn 2006/95/CE en EMC Richtlijn 2004/108/CE.



- Zware industriële kolomboormachines met tandwiel overbrenging en elektromagnetische voeding.
- Kolomboormachines met tandwieloverbrenging.
 - Elektromagnetische voeding, door een eenvoudige druk op één van de knoppen in de handgreep wordt de automatische voeding in- en uitgeschakeld.
 - 2 voedingen aanwezig (St.37) : 0,1 mm/omw. 0,2 mm/omw.
 - Opname MK4.
 - Stille kwalitatieve elektromotoren.
 - Grote uitlading van 350 mm, waardoor grotere stukken kunnen worden bewerkt.
 - Spil met precisie kogellagering.
 - Hoge rondloopnauwkeurigheid door geharde en geslepen hoofdspindel.
 - Tandwieloverbrenging wordt gesmeerd in een oliebad. Alle tandwielen en assen zijn geslepen en gehard.
 - Zware, precies bewerkte werktafel met T-gleuven in diagonaalpatroon en 360° draaibaar rond de kolom, voorzien van dubbele klemming. D.m.v. van een brede tandlat wordt de tafel eenvoudig in de hoogte versteld.
 - Eenvoudigere gereedschapswissel door automatische booruitdrijver
 - Massieve, grote bodemplaat met T-gleuven.
 - Ingewerkte halogeen machineverlichting 12V
 - Stalen handgreep uit drie stukken met afzonderlijke voeding activatie drukknoppen.
 - Gebruiksvriendelijke bedieningsknoppen met aparte start- en stopdrukknop en aparte noodstop.
 - Degelijke boorafscherming uitgerust met veiligheidsschakelaar
 - Gesloten koelvloeistofsysteem met koelpomp 40W
 - Tapfunctie (rechtsdraaiend tot op een bepaalde vooraf ingestelde diepte om vervolgens automatisch linksdraaiend terug te keren).
 - Keuzeschakelaar twee snelheden
 - Links- en rechtsdraaiend
 - Ook verkrijgbaar in andere voltages: 713334405 - 3x220V/50Hz en 713334402 - 3x440V/60Hz. Voor actuele prijzen raadpleeg onze binnendienst.

Opmerking: 3x220V = krachtstroom (drijfkracht). Dit is niet hetzelfde als 1x230V mono = wisselstroom

Order nr.		713334400
Orig. nr.		B40GSM
Spanning	V	3x400
Vermogen motor	kW	1,5
Boorcapaciteit in staal S235JR	mm	35
Boorcapaciteit bij continu gebruik S235JR	mm	35
Draadsnijcapaciteit in staal S235JR	M	24
Spilopname	MK	4
Uitlading	mm	350
Aantal snelheden		18
Spindeltoerental	min-1	50-1450
Boordiepte	mm	180
Diameter kolom	mm	150
Afstand spindel-tafel	mm	780
Afmetingen tafel (b x d)	mm	560x560
T-gleuven	mm	18
Draaibaarheid boortafel	°	360
Afstand spindel-voet	mm	1320
Afmetingen voet (b x d)	mm	510x500
T-gleuven voet	mm	18
Gewicht	kg	500,00
Afmetingen (l x b x h)	mm	935 x 560 x 2280
Prijs	€	4.290,00

OPTIMA

“Heavy Duty” industriële kolomboormachines met tandwiel overbrenging en elektromagnetische voeding.

- Kolomboormachines met tandwieloverbrenging.
- Elektromagnetische voeding, door een eenvoudige druk op één van de knoppen in de handgreep wordt de automatische voeding in- en uitgeschakeld.
- 6 voedingen aanwezig (St.37) : 0,05 / 0,1 / 0,15 / 0,20 / 0,25 / 0,30mm/omw.
- Gemotoriseerde werktafel
- Opname MK4.
- Stille kwalitatieve elektromotoren.
- Grote uitlading van 375 mm, waardoor grotere stukken kunnen worden bewerkt.
- Spil met precisie kogellagering.
- Hoge rondlooppauwkeurigheid door geharde en geslepen hoofdspindel.
- Tandwieloverbrenging wordt gesmeerd in een oliebad. Alle tandwielen en assen zijn geslepen en gehard.
- Zware, precies bewerkte werktafel met T-gleuven in diagonaalpatroon en 360° draaibaar rond de kolom, voorzien van dubbele klemming. D.m.v. van een brede tandlat wordt de tafel eenvoudig in de hoogte versteld.
- Eenvoudigere gereedschapswissel door automatische booruitdrijver
- Massieve, grote bodemplaat met T-gleuven.
- Ingewerkte halogeen machineverlichting 12V
- Gebruiksvriendelijke bedieningsknoppen met aparte start- en stopdrukknop en aparte noodstop.
- Degelijke boorafscherming uitgerust met veiligheidsschakelaar
- Gesloten koelvloeistofsysteem met koelpomp 40W
- Tapfunctie (rechtsdraaiend tot op een bepaalde vooraf ingestelde diepte om vervolgens automatisch linksdraaiend terug te keren).
- Keuzeschakelaar twee snelheden
- Links- en rechtsdraaiend
- B50GSM ook verkrijgbaar in andere voltages: 3x220V/50Hz en 3x440V/60Hz.

Opmerking: 3x220V = krachtstroom (drijfkracht). Dit is niet hetzelfde als 1x230V mono = wisselstroom

Order nr.	713034508 	
Orig. nr.		B50GSM
Spanning	V	3x400
Vermogen motor	kW	3,0/2,4
Boorcapaciteit in staal S235JR	mm	50
Boorcapaciteit bij continu gebruik S235JR	mm	45
Draadsnijcapaciteit in staal S235JR	M	42
Spilopname	MK	4
Uitlading	mm	375
Aantal snelheden		18
Spindeltoerental	min-1	54-2090
Diameter kolom	mm	200
Afstand spindel-tafel	mm	800
Afmetingen tafel (b x d)	mm	600x600
T-gleuven	mm	18
Maximum belastbaar gewicht	kg	300
Afstand spindel-voet	mm	1300
Afmetingen voet (b x d)	mm	600x520
T-gleuven voet	mm	18
Gewicht	kg	950,00
Afmetingen (l x b x h)	mm	1134 x 600 x 2460
Prijs	€	7.690,00



B50GSM

ACCESSOIRES

p.1014-1091

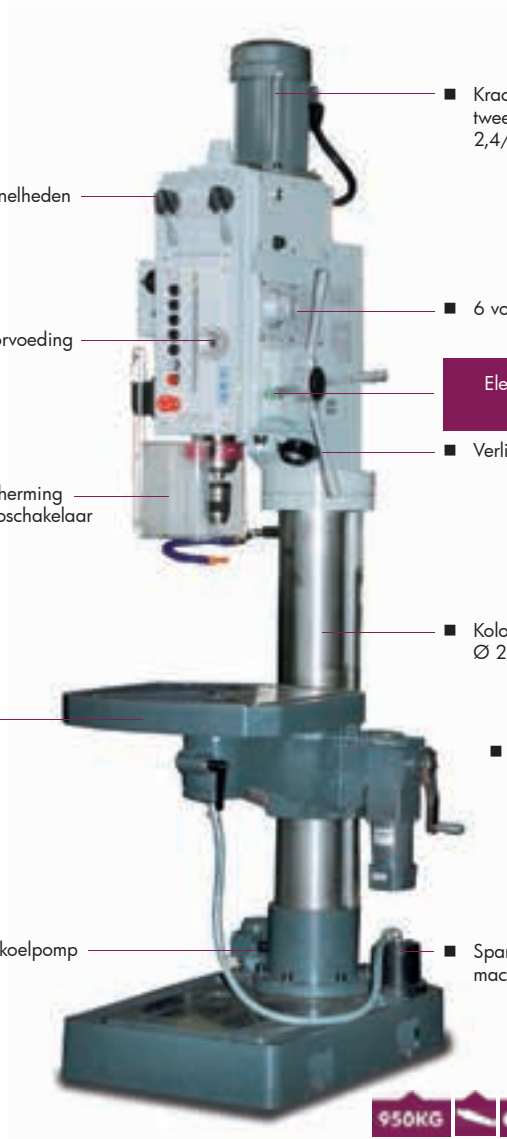
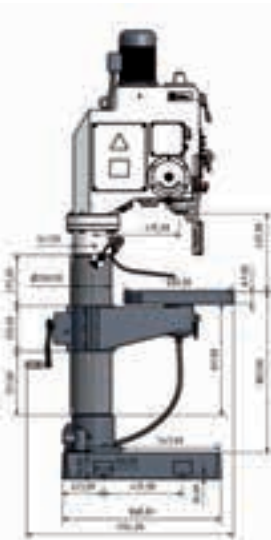
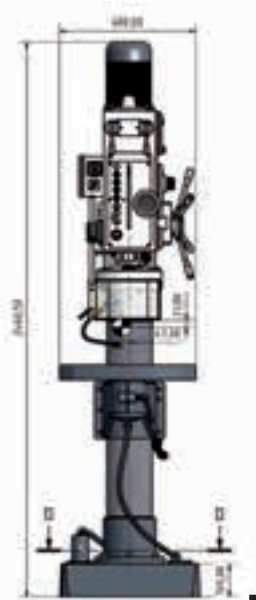

- Krachtige tweesnelheidsmotor 2,4/3,0 kW
- 18 spilsnelheden
- 6 voedingen
- fijne boorvoeding
- Elektromagnetische voeding
- Verlichting
- Boorafscherming met microscharakelaar
- Kolomdiameter Ø 200 mm
- Gemotoriseerde werktafel
- Zware gietijzeren tafel
- Geïntegreerde koelpomp
- Spanenfilter volgens machinerichtlijn

950KG

Standaard geleverd met :

- Optimum snelspan boorkop 0-16 mm B16
- Kegeldoorn volgens DIN228 MK4 B16
- 2 T-moeren voor T-gleuf 18mm en draad M16.
- Nederlandstalige handleiding, opschriften, CE - kenmerk, en CE-attest volgens Machine richtlijn 2006/42/CE, Laagspanningsrichtlijn 2006/95/CE en EMC Richtlijn 2004/108/CE



Zware tandwiel aangedreven kolomboormachines voor de veeleisende industrie.

- Met maar liefst 3 jaar Optimum garantie
- Geproduceerd in de EU, topafwerking in de beste kwaliteit door hoogwaardige componenten, waardoor een hoge werkzekerheid en uiterst lange levensduur.
- Als unicum boorcapaciteit opgave in staal ST60, enkel mogelijk door een perfecte uitlijning van de geharde en geslepen tandwielen.
- Door deze uiterst krachtige tandwieloverbrenging is een geringe motor mogelijk en bespaart u zo op uw elektriciteitsrekening.
- Gietijzere dikwandige kolom voor grote krachtopnames en stabiliteit
- Precieze omloopnauwkeurigheid door geharde en geslepen hoofdspindel uit hoogwaardig staal.
- Hoge continue boorcapaciteit
- Automatische booruitdrijver
- Degelijke boorafscherming met microschakelaar, boormachine valt onmiddellijk stil bij het openen van de afscherming
- Geïntegreerde tapfunctie
- Elektrische kast en componenten uitsluitend van Europese makelij.
- Opname MK3.
- Krachtige, stille 2 stappen motor.
- Rechts / links draairichting
- Groot gedimensioneerde gietijzere werktafel, geslepen en voorzien van T-gleuven
- Massieve, grote bodemplaat.
- Snelheidsinstelling door twee keuzeschakelaars aan de rechter zijkant van de boorkop
- Gebruiksvriendelijke bedieningsknoppen met aparte start- en stopdrukknop en aparte noodstop.
- Vergrendelbare hoofdschakelaar
- Andere voltages: 3x220V en 3x440V op aanvraag.

Opgepast: snelspan boorkop en kegeldoorn zijn NIET inbegrepen

Volledig gemonteerde machine

Order nr.	713041030	
Orig. nr.		DZ25
Spanning	V	3x400
Vermogen motor	kW	0.8/1.2
Boorcapaciteit in staal ST60 - E335	mm	25
Boorcapaciteit bij continu gebruik in staal ST60 - E335	mm	25
Tappen in staal ST60 - E335		M22
Spilopname	MK	3
Uitlading	mm	250
Aantal snelheden		8
Spindeltoerental	min-1	65-3060
Boordiepte	mm	120
Diameter kolom	mm	100
Afstand spindel-tafel	mm	170-680
Afmetingen tafel (b x d)	mm	270x300
T-gleuven	mm	14/2/150
Draaibaarheid boortafel	°	360
Maximum belastbaar gewicht	kg	160
Afstand spindel-voet	mm	1185
Afmetingen voet (b x d)	mm	380x600
Gewicht	kg	260,00
Afmetingen (l x b x h)	mm	600 x 805 x 2025
Prijs	€	4.990,00

**PREMIUM
line**

MK3

3 JAAR GARANTIE

NEW

ACCESSOIRES

Made in Europe

p.1014-1091

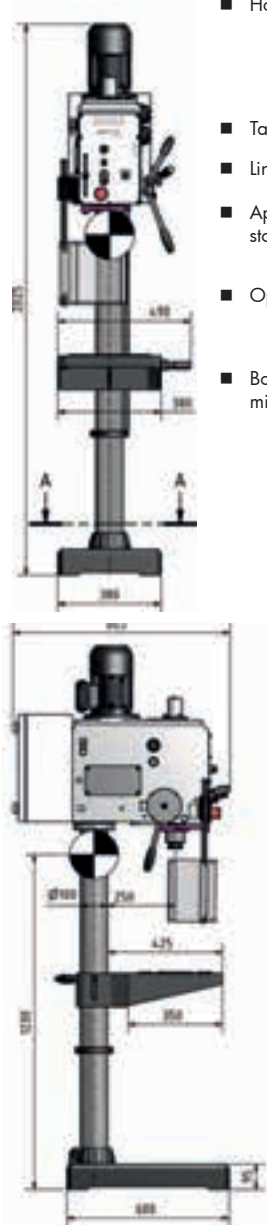

- Hoogwaardige hoofspindel 0,8/1,2 KW
- Tapfunctie
- Links-rechts schakelaar
- Aparte noodstop, start - stopknop
- Optionele boorkop en boor
- Booraafscherming met microscharnelaar
- Aparte elektrische kast
- Krachtige tandwieloverbrenging
- Vergrendelbare hoofdscharnelaar
- Dikwandige, gietijzeren kolom
- Robuuste werktafel over tandlat verstelbaar



Standaard geleverd met :

- Nederlandse handleiding, opschriften, CE - kenmerk, en CE-attest volgens Machine richtlijn 2006/42/CE, Laagspanningsrichtlijn 2006/95/CE en EMC Richtlijn 2004/108/CE

**OPTIMUM**

Zware tandwiel aangedreven kolomboormachines voor de veeleisende industrie met mechanische boorvoedingen en koelvloeistofstelsystemen.

- Met maar liefst 3 jaar Optimum garantie
- Geproduceerd in de EU, topafwerking in de beste kwaliteit door hoogwaardige componenten, waardoor een hoge werkzekerheid en uiterst lange levensduur.
- Als unicum boorcapaciteit opgave in staal ST60, enkel mogelijk door een perfecte uitlijning van de geharde en geslepen tandwielen.
- Tandwielen continu gesmeerd in een oliebad, doorheen gans de kast.
- Door deze uiterst krachtige tandwieloverbrenging is een geringe motor mogelijk en bespaart u zo op uw elektriciteitsrekening.
- Automatische mechanische boorvoedingen
- Gietijzeren dikwandige kolom voor grote krachtopnames en stabiliteit
- Precieze omloopnauwkeurigheid door geharde en geslepen hoofdspindel uit hoogwaardig staal.
- Hoge continue boorcapaciteit
- Automatische booruitdrijver
- Degelijke boorafscherming met microschatelaar, boormachine valt onmiddellijk stil bij het openen van de afscherming
- Geïntegreerde tapfunctie
- Elektrische kast en componenten uitsluitend van Europese makelij.
- Opname MK4.
- Krachtige, stille 2 stappen motor.
- Machineverlichting
- Gesloten koelvloeistofstelsysteem met koelpomp
- Rechts / links draairichting
- Groot gedimensioneerde gietijzeren werktafel, geslepen en voorzien van T-gleuven
- Massieve, grote bodemplaat.
- Snelheidsinstelling door twee keuzeschakelaars aan de rechter zijkant van de boorkop
- Gebruiksvriendelijke bedieningsknoppen met aparte start- en stopdrukknop en aparte noodstop.
- Vergrendelbare hoofdschatelaar
- Andere voltages: 3x220V en 3x440V op aanvraag.

Opgepast: snelspan boorkop en kegeldoorn zijn NIET inbegrepen

Volledig gemonteerde machine

Order nr.		713041060 M
Orig. nr.		DZ35
Spanning	V	3x400
Vermogen motor	kW	0.9/1.5
Boorcapaciteit in staal ST60 - E335	mm	35
Boorcapaciteit bij continu gebruik in staal ST60 - E335	mm	35
Tappen in staal ST60 - E335		M28
Spilopname	MK	4
Uitlading	mm	300
Aantal snelheden		8
Spindeloorental	min-1	75-2100
Boordiepte	mm	160
Diameter kolom	mm	125
Afstand spindel-tafel	mm	70/885
Afmetingen tafel (b x d)	mm	400x420
T-gleuven	mm	16/3/121
Draaibaarheid boortafel	°	360
Maximum belastbaar gewicht	kg	180
Afstand spindel-voet	mm	1245
Afmetingen voet (b x d)	mm	310x288
T-gleuven voet	mm	18/2/180
Gewicht	kg	317,00
Afmetingen (l x b x h)	mm	520 x 860 x 2260
Prijs	€	7.690,00

**PREMIUM
line**

MK4

3 JAAR GARANTIE

NEW

ACCESSOIRES

p.1014-1091

Made in Europe

0,9/1,5 KW

- Tandwielen in continu gesmeerd in een oliebad

- Tapfunctie

- Links-rechts schakelaar

- Aparte noodstop, start - stopknop

- Optionele boorkop en boor

- Booraafscherming met microscharakelaar

- Aparte elektrische kast

- Krachtige tandwieloverbrenging

- Automatische mechanische voedingen

- Vergrendelbare hoofdscharakelaar

- Dikwandige, gietijzeren kolom

- Robuuste werktafel over tandlat verstelbaar

- Gesloten koelvloeistofsysteem



Standaard geleverd met :

- Nederlandstalige handleiding, opschriften, CE - kenmerk, en CE-attest volgens Machine richtlijn 2006/42/CE, laagspanningsrichtlijn 2006/95/CE en EMC Richtlijn 2004/108/CE



Zware tandwiel aangedreven kolomboormachines voor de veeleisende industrie met mechanische boorvoedingen en koelvloeistofsysteem.

- Met maar liefst 3 jaar Optimum garantie
- Geproduceerd in de EU, topafwerking in de beste kwaliteit door hoogwaardige componenten, waardoor een hoge werkzekerheid en uiterst lange levensduur.
- Als unicum boorcapaciteit opgave in staal ST60, enkel mogelijk door een perfecte uitlijning van de geharde en geslepen tandwielen.
- Tandwielen continu gesmeerd in een oliebad, doorheen gans de kast.
- Door deze uiterst krachtige tandwieloverbrenging is een geringe motor mogelijk en bespaart u zo op uw elektriciteitsrekening.
- Automatische mechanische boorvoedingen
- Gietijzeren dikwandige kolom voor grote krachtopnames en stabiliteit
- Precieze omloopnauwkeurigheid door geharde en geslepen hoofdspindel uit hoogwaardig staal.
- Hoge continue boorcapaciteit
- Automatische booruitdrijver
- Degelijke boorafscherming met microscharnelaar, boormachine valt onmiddellijk stil bij het openen van de afscherming
- Geïntegreerde tapfunctie
- Elektrische componenten uitsluitend van Europese makelij.
- Opname MK4.
- Krachtige, stille 2 stappen motor.
- Machineverlichting
- Gesloten koelvloeistofsysteem met koelpomp
- Rechts / links draairichting
- Groot gedimensioneerde gietijzeren werktafel, geslepen en voorzien van T-gleuven, draaibaar en schuinstelbaar.
- Massieve, grote bodemplaat.
- Snelheidsinstelling door twee keuzeschakelaars aan de rechter zijkant van de boorkop
- Gebruiksvriendelijke bedieningsknopen met aparte start- en stopdrukknop en aparte noodstop.
- Vergrendelbare hoofdscharnelaar
- Andere voltages: 3x220V en 3x440V op aanvraag.

Opgepast: snelspan boorkop en kegeldoorn zijn NIET inbegrepen.

Order nr.		713041070 
Orig. nr.		DZ40
Spanning	V	3x400
Vermogen motor	kW	1.5
Boorcapaciteit in staal ST60 - E335	mm	40
Boorcapaciteit bij continu gebruik in staal ST60 - E335	mm	40
Tappen in staal ST60 - E335		M35
Spilopname	MK	4
Uitlading	mm	350
Aantal snelheden		8
Spindeltoerental	min-1	93-1420
Boordiepte	mm	180
Automatische boorvoedingen		01/0.18/0.24
Diameter kolom	mm	150
Afstand spindel-tafel	mm	95/865
Afmetingen tafel (b x d)	mm	480x480
T-gleuven	mm	16/3/125
Draaibaarheid boortafel	°	360
Maximum belastbaar gewicht	kg	200
Afstand spindel-voet	mm	1201
Afmetingen voet (b x d)	mm	356x370
T-gleuven voet	mm	16/2/220
Gewicht	kg	435,00
Afmetingen (l x b x h)	mm	820 x 565 x 2300
Prijs	€	9.250,00

DZ40

**PREMIUM
line**

MK4

ACCESSOIRES

Made in Europe

3 JAAR GARANTIE

NEW

p.1014-1091

1,5 KW

- Tandwielen in continu gesmeerd in een oliebad

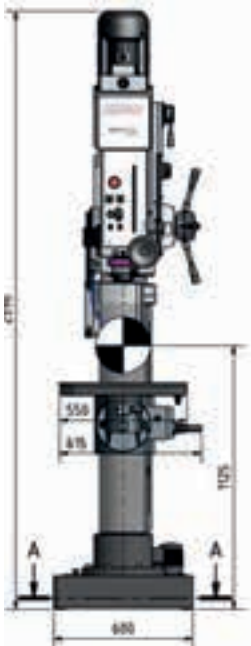

- Tapfunctie
- Links-rechts schakelaar
- Aparte noodstop, start-stopknop
- Handwiel voor fijne boorvoeding
- Optionele boorkop en boor
- Booraafscherming met microscharnelaar

- Automatische mechanische voedingen

- Vergrendelbare hoofdscharnelaar

- Dikwandige, gietijzeren kolom

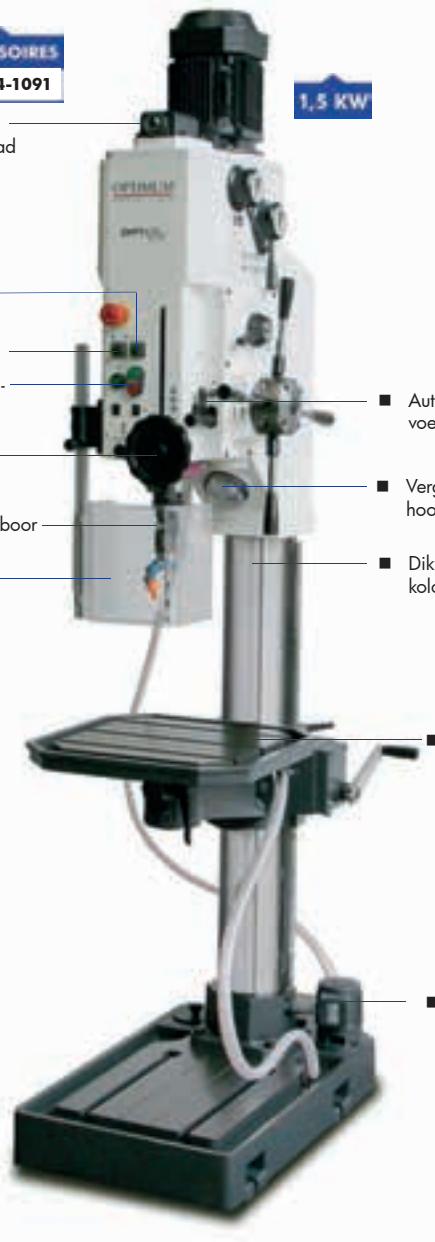

- Robuuste werktafel over tandlat verstelbaar

- Gesloten koelstroomsysteem

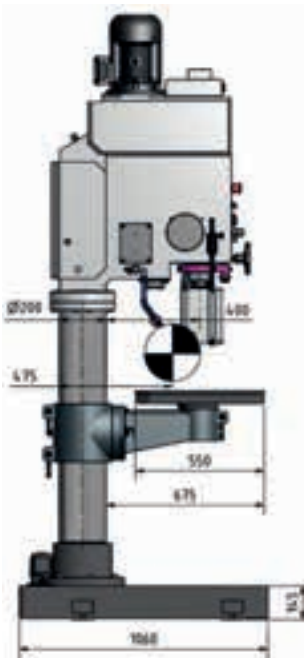

Standaard geleverd met :

- Nederlandstalige handleiding, opschriften, CE - kenmerk, en CE-attest volgens Machine richtlijn 2006/42/CE, laagspanningsrichtlijn 2006/95/CE en EMC Richtlijn 2004/108/CE



Zware tandwiel aangedreven kolomboormachines voor de veeleisende industrie met mechanische boorvoedingen en koelvloeistofstelsysteem.

- Met maar liefst 3 jaar Optimum garantie
- Geproduceerd in de EU, topafwerking in de beste kwaliteit door hoogwaardige componenten, waardoor een hoge werkzekerheid en uiterst lange levensduur.
- Als unicum boorcapaciteit opgave in staal ST60, enkel mogelijk door een perfecte uitlijning van de geharde en geslepen tandwielen.
- Tandwielen continu gesmeerd in een oliebad, doorheen gans de kast.
- Door deze uiterst krachtige tandwieloverbrenging is een geringe motor mogelijk en bespaart u zo op uw elektriciteitsrekening.
- Automatische mechanische boorvoedingen
- Gietijzeren dikwandige kolom voor grote krachtopnames en stabiliteit
- Precieze omloopnauwkeurigheid door geharde en geslepen hoofdspindel uit hoogwaardig staal.
- Hoge continue boorcapaciteit
- Automatische booruitdrijver
- Degelijke boorafscherming met microschakelaar, boormachine valt onmiddellijk stil bij het openen van de afscherming
- Geïntegreerde tapfunctie
- Elektrische componenten uitsluitend van Europese makelij.
- Opname MK4.
- Krachtige, stille 2 stappen motor.
- Machineverlichting
- Gesloten koelvloeistofstelsysteem met koelpomp
- Rechts / links draairichting
- Groot gedimensioneerde gietijzeren werktafel, geslepen en voorzien van T-gleuven
- Massieve, grote bodemplaat met grote T-gleuven.
- Snelheidsinstelling door twee keuzeschakelaars aan de rechter zijkant van de boorkop
- Gebruiksvriendelijke bedieningsknopen met aparte start- en stopdrukknop en aparte noodstop.
- Vergrendelbare hoofdschakelaar
- Andere voltages: 3x220V en 3x440V op aanvraag.

Opgepast: snelspan boorkop en kegeldoorn zijn NIET inbegrepen

Order nr.	713041090	
Orig. nr.		DZ50
Spanning	V	3x400
Vermogen motor	kW	3
Boorcapaciteit in staal ST60 - E335	mm	50
Boorcapaciteit bij continu gebruik in staal ST60 - E335	mm	50
Tappen in staal ST60 - E335		M40
Spilopname	MK	4
Uitlading	mm	400
Aantal snelheden		9
Spindeltoerental	min-1	45-1115
Boordiepte	mm	260
Automatische boorvoedingen		0,08 - 0,16 - 0,24 - 0,35
Diameter kolom	mm	200
Afstand spindel-tafel	mm	70/800
Afmetingen tafel (b x d)	mm	550x550
T-gleuven	mm	18/3/160
Draaibaarheid boortafel	°	360
Maximum belastbaar gewicht	kg	275
Afstand spindel-voet	mm	1270
Afmetingen voet (b x d)	mm	500x700
T-gleuven voet	mm	16/3/138
Gewicht	kg	850,00
Afmetingen (l x b x h)	mm	1060 x 615 x 2590
Prijs	€	12.790,00

**PREMIUM
line**



3 JAAR GARANTIE

NEW

ACCESSOIRES

p.1014-1091

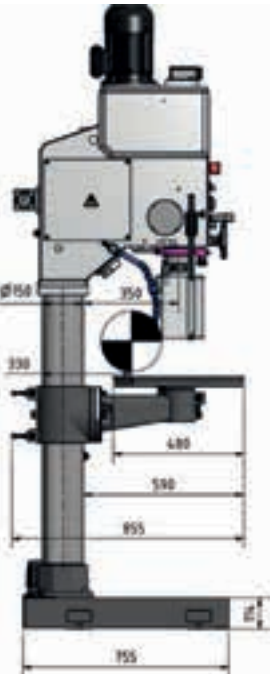
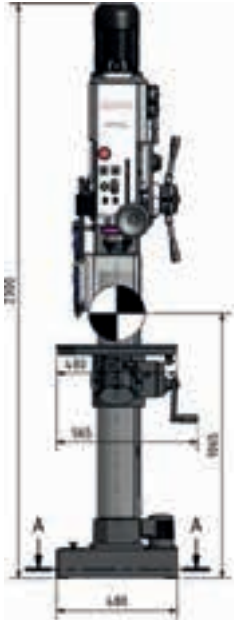

- Tandwielen in continu gesmeerd in een oliebad
- Tapfunctie
- Links-rechts schakelaar
- Aparte noodstop, start-stopknop
- Handwiel voor fijne boorvoeding
- Optionele boorkop en boor
- Boorafscherming met microscharrelaar
- Stille, krachtige motor 3 kW
- 9 snelheden 45-1115 min-1
- 4 Automatische mechanische voedingen
- Machineverlichting
- Dikwandige, gietijzeren kolom ø 200
- Robuuste werktafel over tandlat verstelbaar
- Gesloten koelvoelstofsysteem

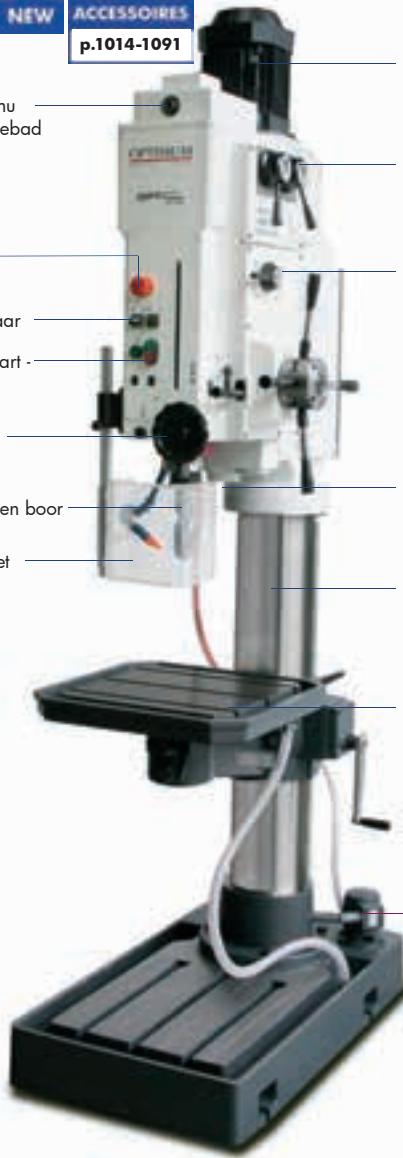

Standaard geleverd met :

- Nederlandstalige handleiding, opschriften, CE - kenmerk, en CE-attest volgens Machine richtlijn 2006/42/CE, Laagspanningsrichtlijn 2006/95/CE en EMC Richtlijn 2004/108/CE



Precieze, massieve radiaalboormachine is ideaal voor diverse doeleinden voor stuk- en serieproductie.

Argumenten, die in kwaliteit, prestatie en prijs overtuigen:

- Veelzijdig inzetbereik boren, ruimen, tappen.
- Sterk presterende kwaliteitsmotor
- Zware, massieve, hoogwaardige kwaliteitsgietijzer
- Brede uitlading door horizontaal verstelbare machinekop
- DR 4 / DR 5 opname MK4; DR 6 opname MK 5
- Boordiepte instelling over een millimeterschaal
- Stalen dikwandige kolom voor grote krachtopnames en stabiliteit
- De geleidingen van de arm zijn gehard en precisie geslepen
- Duurzame en robuuste constructie van de arm
- De hoogteverstelling van de arm gebeurt over een krachtige motoraandrijving en vijzel.
- Tandwielen van de arm worden gesmeerd in een oliebad
- Aandrijftandwielen zijn vervaardigd uit Chroom - Nikkel - Staal gehard en precisie geslepen, waardoor geluidsarme en gelijkmatige loop
- De boorkop en zuil kunnen gelijktijdig of afzonderlijk geklemd worden als gelost worden.
- DR 4 - alle assen worden manueel geklemd
- DR 5 - Z zuil worden manueel geklemd, de arm en de boorkop worden hydraulisch geklemd
- DR 6 - Alle assen worden hydraulisch geklemd
- Gemakkelijk verplaatsbaar over de assen
- Automatische mechanische boorvoedingen
- Rechts / links lopend.
- Groot gedimensioneerde gietijzeren werktafel, geslepen en gehard, voorzien van T-gleuven in het horizontale als verticale vlak
- Massieve, grote bodemplaat met grote T-gleuven.
- In de bodemplaat is een koelpomp en koeltank geïntegreerd.
- Gebruiksvriendelijke bedieningsknopen met aparte start- en stopdrukknop en aparte noodstop
- Degelijke boorafscherming met microscharnelaar, boormachine valt onmiddellijk stil bij het openen van de afscherming
- Vergrendelbare hoofdscharnelaar
- Machineverlichting
- Andere voltages: 3x220V en 3x440V op aanvraag.

Opgepast: snelspan boorkop en kegeldoorn zijn NIET inbegrepen.

Order nr.		713335040	713335050	713335060
Orig. nr.		DR4	DR5	DR6
Spanning	V	3x400	3x400	3x400
Gezamenlijk vermogen	kW	3	5	7
Spil aandrijfmotor	kW	1.5	3	4
Ram aandrijfmotor	kW	0.75	1.1	1.5
Boorcapaciteit in staal S235JR	mm	40	40	50
Boorcapaciteit bij continu gebruik S235JR	mm	36	36	46
Tapcapaciteit in staal S235JR		40	M30	M36
Verplaatsing boorkop horizontaal	mm	120-700	1000	1250
Verplaatsing arm verticaal	mm	510	550	600
Afstand spindel - kolom	mm	320-1020	300-1300	350-1600
Afstand spindel-voet (maximum)	mm	250-1000	300-1120	320-1220
Spilopname		MK4	MK4	MK5
Spilverplaatsing	mm	280	280	315
Voedingen	mm/omw	0.1-0.25 (3)	0.1-1.25 (8)	0.04-3.2 (16)
Snelheden	min-1	75-1220	32-2500	38-2000
Aantal snelheden		6	16	16
Dalen/stijgen verplaatsingsnelheid	mm/min	1270	1270	1200
Draaihoek	°	+/-180	+/-180	+/-180
Afmetingen voet (l x b)	mm	1360x687	2030x885	2380x985
Werkvlak monteertafel	mm	400x400x350	600x450x450	620x500x500
Afmetingen met arm (gedraaid)	mm	1760x1760x2100	2100x2100x2490	2500x2500x2840
Gewicht	kg	1230,00	2100,00	3500,00
Afmetingen (l x b x h)	mm	1750 x 770 x 2100	2100 x 750 x 2490	2500 x 1070 x 2840
Prijs	€	8.150,00	12.990,00	17.490,00

MK4
MK5
NEW
ACCESSOIRES
p.1014-1091

DR4 - DR5 - DR6

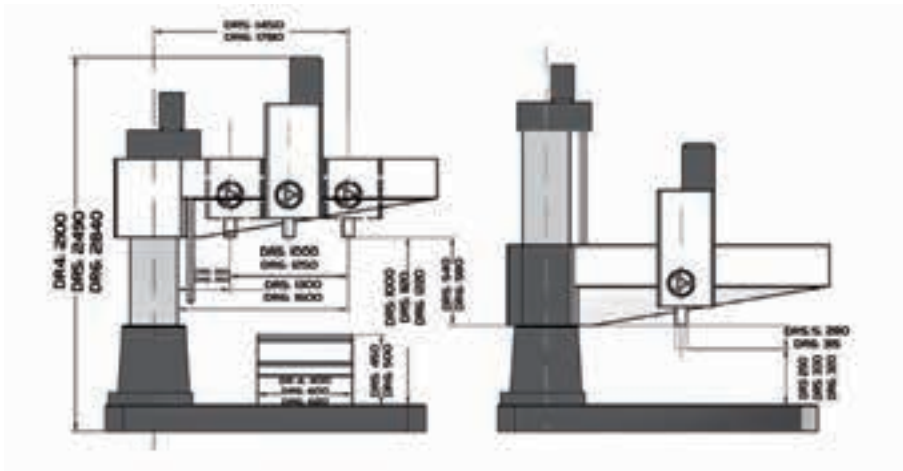
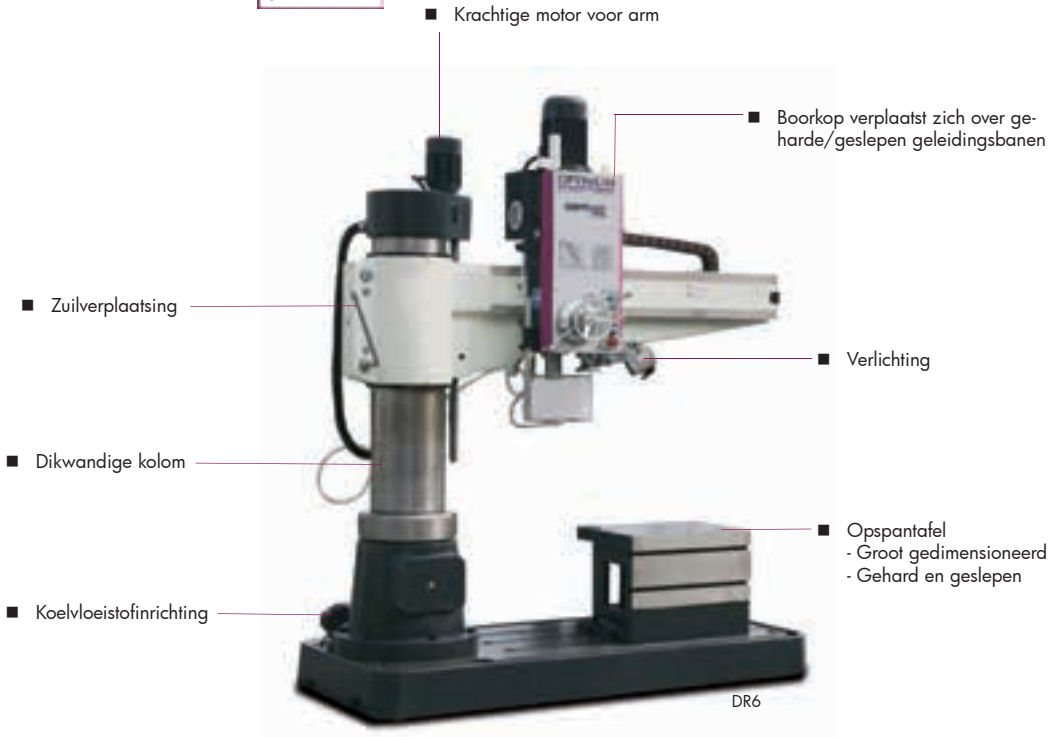

Standaard geleverd met :

- DR 5 hydraulische klemming van de boorkop
- DR 6 hydraulische klemming van alle assen
- Koelvloeistofstelsysteem
- Machineverlichting
- Nederlandstalige handleiding, opschriften, CE - kenmerk, en CE-attest volgens Machine richtlijn 2006/42/CE, Laagspanningsrichtlijn 2006/95/CE en EMC Richtlijn 2004/108/CE

KIES UW BOORMACHINE

	Vermogen	Boorvermogen in staal	Spilprofiel	Uplading in mm	Snelheden	Traploze spilheden	Koelrichting	Tapfunctie	Automatische voeding	Machieverlichting	Snelplan boorloop	230V versie	400V versie	Tafelboormachine	Kolomboormachine	Tandwiel aangedreven	Radiaal boormachine
B13	0,3	Ø 13	vast B16	104	520-2620							●		●			
B14	0,35	Ø 14	vast B16	104	520-2620						●	●		●			
B16	0,45	Ø 16	MK2	125	660 - 2500						●	●		●			
B20	0,55	Ø 20	MK2	170	210-2220						●	●		●			
B25	0,55	Ø 20	MK3	170	210-2220						●	●	●		●		
B 32	1,1	Ø 32	MK4	225	140-2020						●	●	●		●		
RB 6T	0,75	Ø 16	MK2	115-430	390-3000							●					●
RB 85	0,75	Ø 16	MK2	115-430	390-3000							●					●
B 17 Pro	0,5	Ø 16	MK2	180	500-2520						●	●		●			
B 23 Pro	0,75	Ø 25	MK2	180	200-2440						●	●	●	●	●		
B 26 Pro	0,75	Ø 25	MK3	10	200-2440						●	●	●		●		
B 33 Pro	1,1	Ø 30	MK4	254	120-1810						●	●	●				
B 23 Pro Vario	0,75	Ø 25	MK2	180	30-3500	●					●	●	●	●			
B 26 Pro Vario	0,75	Ø 25	MK3	210	30-3500	●					●	●	●		●		
B 33 Pro Vario	1,5	Ø 30	MK4	254	20-3500	●					●	●	●		●		
B24 H	0,85	Ø 24	MK2	165	350-4000					●	●	●	●	●			
B28 H	0,85	Ø 28	MK3	200	120-4000					●	●	●	●		●		
B34 H	1,5/2,2	Ø 34	MK4	285	145-4800					●	●	●	●		●		
B16 HV	0,55	Ø 16	MK2	130	100-7500	●				●	●	●		●			
B24 HV	0,85	Ø 24	MK2	165	100-5950	●				●	●	●		●			
B28 HV	0,85	Ø 28	MK3	200	35-5600	●	●			●	●	●			●		
B34 HV	1,5/2,2	Ø 34	MK4	285	40-5000	●	●			●	●	●			●		
B30 BS	2,2	Ø 30	MK3	285	30-3900	●	●	●		●	●	●			●		
B 30 VGM	2,5	Ø 30	MK3	285	80 - 3000	●	●	●		●	●	●			●	●	
DH 26 GT	0,65	Ø 26	MK3	255	105-2900				●				●		●	●	
DH 28 GS	0,65	Ø 26	MK3	255	105-2900				●	●	●	●	●		●	●	
DH 32 GS	1,1/1,5	Ø 32	MK4	285	75-2000				●	●	●	●	●		●	●	
B40 E	1,1/1,5	Ø 28	MK4/M16	285	95 - 3200				●		●	●	●		●	●	
B40 PTE	1,1/1,5	Ø 32	MK4/M16	285	95 - 3200				●	mechan.	●	●	●		●	●	
B40 GSP	1,5	Ø 35	MK4	350	64 - 3060				●	mechan.	●	●	●		●	●	
B40 GSM	1,5	Ø 35	MK4	350	64 - 3060				●	elek mag	●	●	●		●	●	
DZ 25	0,8 / 1,2	Ø 25	MK3	250	64 - 3060					●		●	●		●	●	
DZ 35	0,8 / 1,2	Ø 35	MK4	300	75 - 2100				●	mechan.	●	●	●		●	●	
DZ 40	1,5	Ø 40	MK4	350	93 - 1420				●	mechan.	●	●	●		●	●	
DZ 50	3	Ø 50	MK4	400	45 - 685				●	mechan.	●	●	●		●	●	
B50 GSM	3/2,4	Ø 50	MK4	375	54-2090				●	elek mag	●	●	●		●	●	
DR4	3	Ø40	MK4	580	75-1220		●		mechan.	●	●	●	●		●	●	●
DR5	5	Ø 40	MK4	1000	32-2500		●		mechan.	●	●	●	●		●	●	●
DR6	7	Ø 50	MK5	1250	38-2000		●		mechan.	●	●	●	●		●	●	●

KIES DE ACCESSOIRES VOOR UW BOORMACHINE

ACCESSOIRES
p.1014-1091

Accessoires voor boormachines		B13	B14	B16	B20	B25	B32	RB 6T	RB 8S	B17 Pro	B23 Pro/Vario	B26 Pro/Vario	B33 Pro/Vario	B16 H/Vario	B24 H/Vario	B28 H/Vario	B34 H/Vario	DH 28BV	DH 28BV	DH 34BV	B30 BS Vario	DH 36GT	DH 32GS	DH 32GS	B30 VGM	B40E/B40 PTE	B40 GSM/GSP	B50 GSM	
Boorkop MK2/1-16 mm	713050571			•	•			•	•	•	•			•	•			•											
Boorkop MK2 1-13 mm	713050572			•	•			•	•	•	•			•	•			•											
Boorkop MK2/0-8 mm	713050582			•	•			•	•	•	•			•	•			•											
Boorkop MK3/0-13 mm	713050585				•	•		•	•		•	•			•			•		•		•	•	•		•			
Boorkop MK3/0-16 mm	713050573					•					•	•						•		•		•	•	•		•			
Boorkop MK4/1-16 mm	713050574						•						•				•							•		•	•	•	•
Boorkop MK4/0-13 mm	713050587						•						•				•							•		•	•	•	•
Boorkop 0-13 mm	713050623	•	•	•	•	•	•	•	•	•	•	•	•	•	•	•	•	•	•	•	•	•	•	•	•	•	•	•	•
Boorkop 0-16 mm	713050626	•	•	•	•	•	•	•	•	•	•	•	•	•	•	•	•	•	•	•	•	•	•	•	•	•	•	•	•
Röhm boorkop 1-13 mm	713050656	•	•	•	•	•	•	•	•	•	•	•	•	•	•	•	•	•	•	•	•	•	•	•	•	•	•	•	•
Röhm boorkop 3-16 mm	713050657	•	•	•	•	•	•	•	•	•	•	•	•	•	•	•	•	•	•	•	•	•	•	•	•	•	•	•	•
Reductie MK3/MK2	713050663					•						•			•			•		•		•	•	•					
Reductie MK4/MK3	713050664						•						•				•							•	•			•	•
Reductie MK4/MK2	713050665						•						•				•							•	•			•	•
Reductie MK4/M16-MK2	790023036																												•
Reductie MK4/M16 -MK3	790023037																												•
Kegeldoorn MK 2 - B16	713050659			•	•			•	•	•	•			•	•			•											
Kegeldoorn MK 3 - B16	713050660					•						•					•			•		•	•	•					
Kegeldoorn MK 4 - B16	713050661						•						•								•				•	•			•
Kegeldoorn MK 5 - B16	790023034																											•	
Spiraalborenset	742162500	•	•	•	•	•	•	•	•	•	•	•	•	•	•	•	•	•	•	•	•	•	•	•	•	•	•	•	•
MK2 borenset	713051002			•	•	•	•	•	•	•	•	•	•	•	•	•	•	•	•	•	•	•	•	•	•	•	•	•	•
MK3 borenset	713051003					•	•								•			•		•		•	•	•	•	•	•	•	•
Tapapparaat	713352042				•	•	•	•	•	•	•	•	•	•	•	•	•	•	•	•	•	•	•	•	•	•	•	•	•
Conus uitdrijver MSP1	713050636			•	•	•	•		•	•	•	•	•	•	•	•	•	•	•	•	•	•	•	•	•				
Conus uitdrijver MSP2	713050637						•						•				•				•			•		•	•	•	•
SB12 set spanbouten	790007315									•	•			•															
SB14 set spanbouten	790007317	•	•	•	•	•	•	•	•	•	•	•	•	•	•	•	•	•	•	•	•	•	•	•	•	•	•	•	•
SB18 set spanbouten	790007319	•	•	•	•	•	•	•	•	•	•	•	•	•	•	•	•	•	•	•	•	•	•	•	•	•	•	•	•
Koelinrichting 230V	713352002	•	•	•	•	•	•	•	•	•	•	•	•	•	•	•	•	•	•	•	•	•	•	•	•	•	•	•	•
Koelinrichting 400V	713352001										•	•	•	•	•	•	•	•	•	•	•	•	•	•	•	•	•	•	•
Boorklem MSO 75	713000075	•	•	•	•	•	•	•	•	•	•	•	•	•	•	•	•	•	•	•	•	•	•	•	•	•	•	•	•
Boorklem MSO 100	713000100	•	•	•	•	•	•	•	•	•	•	•	•	•	•	•	•	•	•	•	•	•	•	•	•	•	•	•	•
Boorklem MSO 125	713000125	•	•	•	•	•	•	•	•	•	•	•	•	•	•	•	•	•	•	•	•	•	•	•	•	•	•	•	•
Boorklem MSO 150	713000150					•	•	•	•	•	•	•	•	•	•	•	•	•	•	•	•	•	•	•	•	•	•	•	•
Boorklem BMS 85	713000008	•	•	•	•	•	•	•	•	•	•	•	•	•	•	•	•	•	•	•	•	•	•	•	•	•	•	•	•
Boorklem BMS 100	713000010	•	•	•	•	•	•	•	•	•	•	•	•	•	•	•	•	•	•	•	•	•	•	•	•	•	•	•	•
Boorklem BMS 120	713000012	•	•	•	•	•	•	•	•	•	•	•	•	•	•	•	•	•	•	•	•	•	•	•	•	•	•	•	•
Boorklem BMS 150	713000015				•	•	•	•	•			•	•	•	•	•	•	•	•	•	•	•	•	•	•	•	•	•	•
Boorklem BMS 200	713000020																												
Boorklem BSI 100	713000210	•	•	•	•	•	•	•	•	•	•	•	•	•	•	•	•	•	•	•	•	•	•	•	•	•	•	•	•
Boorklem BSI 140	713000214						•															•			•	•	•	•	•
Boorklem BSI 200	713000220																												•
Boorklem BSI-Q 100	713000230				•	•	•	•	•			•	•	•	•	•	•	•	•	•	•	•	•	•	•	•	•	•	•
Boorklem BSI-Q 140	713000234						•	•	•			•	•	•	•	•	•	•	•	•	•	•	•	•	•	•	•	•	•
Boorklem BSI-Q 200	713000240											•	•	•	•	•	•	•	•	•	•	•	•	•	•	•	•	•	•

Deze tabel bevat alle aanbevolen accessoires. Afhankelijk van uw individuele situatie, kan het nodig zijn om accessoires te gebruiken.

Pneumatische taparmen

Pneumatische taparmen

METALWORKS

■ Incl. 6 tapkoppen

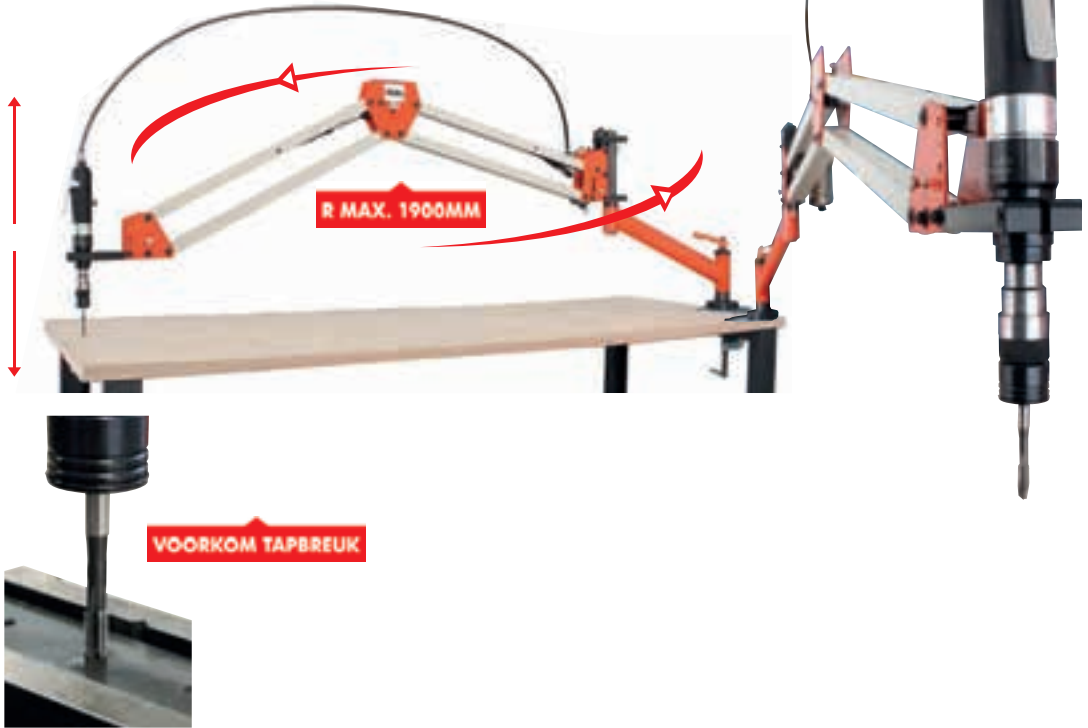

Deze met perslucht aangedreven taparm is uiterst geschikt voor het gebruik in garages, werkplaatsen, opleidingcentra, scholen en verspaningstoepassingen.

Voor iedere tapmaat is er tapkop met slipkoppeling nodig. De slipkoppeling is zodanig ingesteld dat het max. toelaatbare draaimoment nooit overschreden kan worden, hierdoor wordt het breken van de tap in bijvoorbeeld dure werkstukken voorkomen.

Met grote actieradius!

Voordelen : snelheid, nauwkeurig en betrouwbaar.

Aanbevolen compressor: 712007411 - Airstar 401/100 of zwaarder.

Standaard accessoires :

- Degelijke tapspindel
- Beweegbare taparm met gasveren
- Voet
- Luchtdrukregelbaar met manometer
- **6 tapkoppen met slipkoppeling**

Order nr.	790004449 ^M	790004450 ^M	790004451 ^M	790004454 ^M
Orig. nr.	PTA12	PTA16	PTA20	PTA27
Voor tappen	M3-M12	M3-M16	M3-M20	M3-M27
Snelheid	tpm 400	300	150/400	70/220
Effectieve actieradius over 360° (1)	Rmax mm 900	1900	1900	1900
Aanbevolen maximum druk	bar 6	6	6	6
Tapkoppen	M3/4/5/6/8 DIN371 M12 DIN352	M4/5/8/10 DIN371 M12/16 DIN352 + adapter	M8/10 DIN371 M12/16/18/20 DIN352 + adapter	M12/16/18/20/24/27 DIN352 + adapter
Effectieve actieradius over 360° (2)	Rmin mm 200	200	200	200
Luchtverbruik	l/min +/- 800	+/- 950	+/- 950	+/- 950
Gewicht	kg 20,00	25,00	36,00	38,00
Prijs	€ 1.390,00	1.949,00	2.770,00	3.190,00

Tappotten

MITTELWÄRDIG

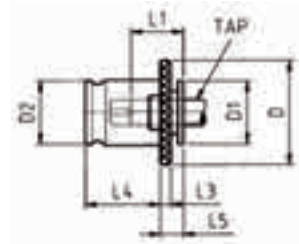

Tapot - snelwissel adaptor met slipkoppeling. Voor gebruik van tappen DIN371 en DIN376. Tap wordt vastgeklit rond de schacht. Tappotten worden altijd gekozen volgens de diameter van de schacht en de vierkantaansluiting. Tap zelf niet inbegrepen. Serie 19 en 31mm.

Order nr.	Orig. nr. ϕ D1	Aansluiting ϕ D1	Geschikt voor tap ϕ D1	Diameter tap ϕ D	Schacht vierkant mm	Prijs €
790004162 M	TKM1930	19	DIN371 M3	3,5	2,7	36,00
790004164 M	TKM1940	19	DIN371 M4	4,5	3,4	36,00
790004166 M	TKM1950	19	DIN371 M5-M6	6	4,9	36,00
790004168 M	TKM1980	19	DIN371 M8	8	6,2	36,00
790004169 M	TKM19100	19	DIN371 M10	10	8	36,00
790004170 M	TKM3150	31	DIN371 M5-M6	6	4,9	51,00
790004172 M	TKM3180	31	DIN371 M8	8	6,2	51,00
790004173 M	TKM31100	31	DIN371 M10	10	8	51,00
790004180 M	TKM19801	19	DIN376 M8	6	4,9	36,00
790004181 M	TKM191001	19	DIN376 M10	7	5,5	36,00
790004182 M	TKM19120	19	DIN376 M12	9	7	36,00
790004185 M	TKM31801	31	DIN376 M8	6	4,9	51,00
790004186 M	TKM311001	31	DIN376 M10	7	5,5	51,00
790004187 M	TKM31120	31	DIN376 M12	9	7	51,00
790004188 M	TKM31140	31	DIN376 M14	11	9	51,00
790004189 M	TKM31160	31	DIN376 M16	12	9	51,00
790004190 M	TKM31180	19	DIN376 M16	14	11	51,00
790004191 M	TKM31200	19	DIN376 M20	16	12	51,00
790004192 M	TKM31220	31	DIN376 M22	18	14,5	51,00
790004193 M	TKM31240	31	DIN376 M24	18	14,6	51,00

Boor-freesmachines



Boor-freesmachine voor de veeleisende modelbouwer.

- Boor-freesmachine met 2-traps tandwieloverbrenging
- Opname MK2 met draadopname M10
- Voor de veeleisende gebruiker in de modelbouw en hobbyist
- Met dynamisch traploos regelbare aandrijving 100 – 3.000 tpm
- Boor-freeskop is langs beide zijden onder hoek instelbaar +/- 90°, maakt de meeste frees- en boorbewerkingen onder iedere hoek mogelijk.
- Boor-freeskop is in de hoogte verstelbaar
- Eenvoudige bediening vooraan
- Gebruiksvriendelijke veiligheidschakelaar IP54 met nullast spanning
- Vastzetten van alle rijwegen mogelijk
- Precieze omloopnauwkeurigheid door kogellagers beter dan 0,015 mm in de spil gemeten
- Stabiele en precieze zwaluwstaartuitvoering met regelbare spie-geleiders op de 3 assen
- Massieve en precies geslepen kruistafel met T-gleuven en koelmiddelrand
- Opklapbare boorafscherming
- Alle verplaatsingen zijn met een schaal aanduiding uitgerust.
- Zonder machinevoet

Order nr.	713338116	
Orig. nr.	BF16 VARIO	
Spanning	V	1x230
Vermogen motor	kW	0,5
Boorcapaciteit in staal S235JR	mm	16
Boorcapaciteit bij continu gebruik S235JR	mm	12
Maximum freescapaciteit vlakfrees	mm	63
Maximum freescapaciteit vingerfrees	mm	20
Spilopname	MK	2/M10
Uitlading	mm	175
Boordiepte	mm	50
Kop zwenkbaar	°	+/-90
Aantal snelheden		2
Spindeltoeren langzaam	min-1	100-1500
Spindeltoeren snel	min-1	200-3000
Rijweg X-as	mm	220
Rijweg Y-as	mm	160
Rijweg Z-as	mm	210
Afmetingen tafel (b x d)	mm	400x120
Afmetingen T-groeven/alstand	mm	10/35
Gewicht	kg	60,00
Afmetingen (l x b x h)	mm	505 x 465 x 795
Prijs	€	999,00

BF16

MK2/M10

ACCESSOIRES

p.1012-1091

0,5KW

VARIO

60kg

■ Traploos regelbare spilsnelheden

■ Omloop nauwkeurigheid
Kleiner dan 0,015mm

■ Massieve kruistafel

■ Machinevoet in optie
713353003

■ Tandwieloverbrenging

■ Boorfreeskop onder hoek
verstelbaar

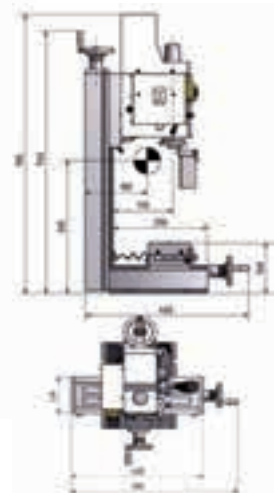

VERPL.

X: 220mm
Y: 160mm
Z: 210mm

Standaard geleverd met :

- Aantrekstang M10
- Bedieningsleutels
- Nederlandstalige handleiding, opschriften, CE - kenmerk, en CE-attest

**OPTI**

- Stabiele boorfreesmachine met elektronische toerental regeling met digitale weergave.
- Boorfreesmachine met 2-traps tandwieloverbrenging, hoog en laag.
- **BF20L Vario heeft een langere verplaatsing in de langsrichting X-as ten opzichte van de BF20 Vario**
- Stille krachtige elektromotor van 850 Watt. Gelijkstroom motor met permanente toerentalbewaking.
- Opname MK2 met draadopname M10
- Met traploos regelbare aandrijving 90 – 3.000 tpm
- Boorfreeskop is langs beide zijden onder hoek instelbaar +/- 90°, maakt de meeste frees- en boorbewerkingen onder iedere hoek mogelijk.
- Boorfreeskop is in de hoogte verstelbaar.
- Kolom is langs beide zijden 30 mm verplaatsbaar, daardoor ook met onder hoek geplaatste boorfreeskop een langere verplaatsing en centrische bewerking van het werkstuk op de kruistafel mogelijk.
- Eenvoudige bediening vooraan met aparte start/stop drukknop en aparte noodstop.
- Keuzeschakelaar links - rechtsdraaiend
- Start / stop verbinding voorzien om optionele CNC sturing aan te sluiten
- Gegoten stervormige handgreep voorzien van Soft grip handvatten.
- Digitale LED weergave van de spilsnelheden
- Vastzetten van alle rijwegen mogelijk en alle verplaatsingen zijn met een schaal aanduiding uitgerust
- Digitale weergave van de diepte instelling, omschakelen tussen mm/inch en afleesbaarheid van 0,01 mm
- Precieze omloopnauwkeurigheid door kogellagers beter dan 0,015 mm in de spil gemeten
- Stabiele en precieze zwaluwstaartuitvoering met regelbare spie-geleiders op de 3 assen
- Massieve en precies geslepen kruistafel met T-gleuven en koelmiddelrand. Langsverplaatsing voorzien van mechanisch instelbare eindeloop schakelaars.
- Boorafscherming voorzien van een microscharakelaar, bij het openen valt de machine stil.
- Geïntegreerde halogeenverlichting 12V, 10W

Order nr.		713338120 ^M	713338122 ^M
Orig. nr.		BF20 VARIO	BF20L VARIO
Spanning	V	1x230	1x230
Vermogen motor	kW	0,85	0,85
Boorcapaciteit in staal S235JR	mm	16	16
Boorcapaciteit bij continu gebruik S235JR	mm	12	12
Maximum freescapaciteit vlakfrees	mm	63	63
Maximum freescapaciteit vingerfrees	mm	20	20
Spilopname	MK	2/M10	2/M10
Uitlading	mm	185	185
Boordiepte	mm	50	50
Kop zwenkbaar	°	+/-90	+/-90
Aantal snelheden		2	2
Spindeltoeren langzaam	min-1	90-1480	90-1480
Spindeltoeren snel	min-1	150-3000	150-3000
Rijweg X-as	mm	280	480
Rijweg Y-as	mm	175	175
Rijweg Z-as	mm	370	370
Afmetingen tafel (b x d)	mm	500x180	700x180
Afmetingen T-groeven/afstand	mm	12/63	12/63
Gewicht	kg	106,00	120,00
Afmetingen (l x b x h)	mm	745 x 565 x 935	950 x 565 x 935
Prijs	€	1.350,00	1.450,00

BF20 VARIO

MK2/M10

ACCESSOIRES
p.1012-1091

0,85 KW VARIO 115kg

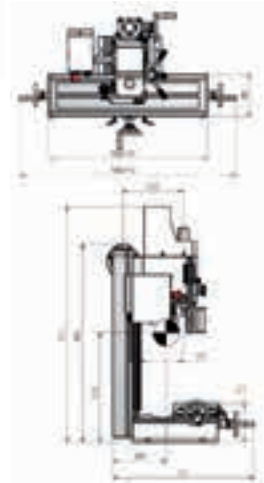
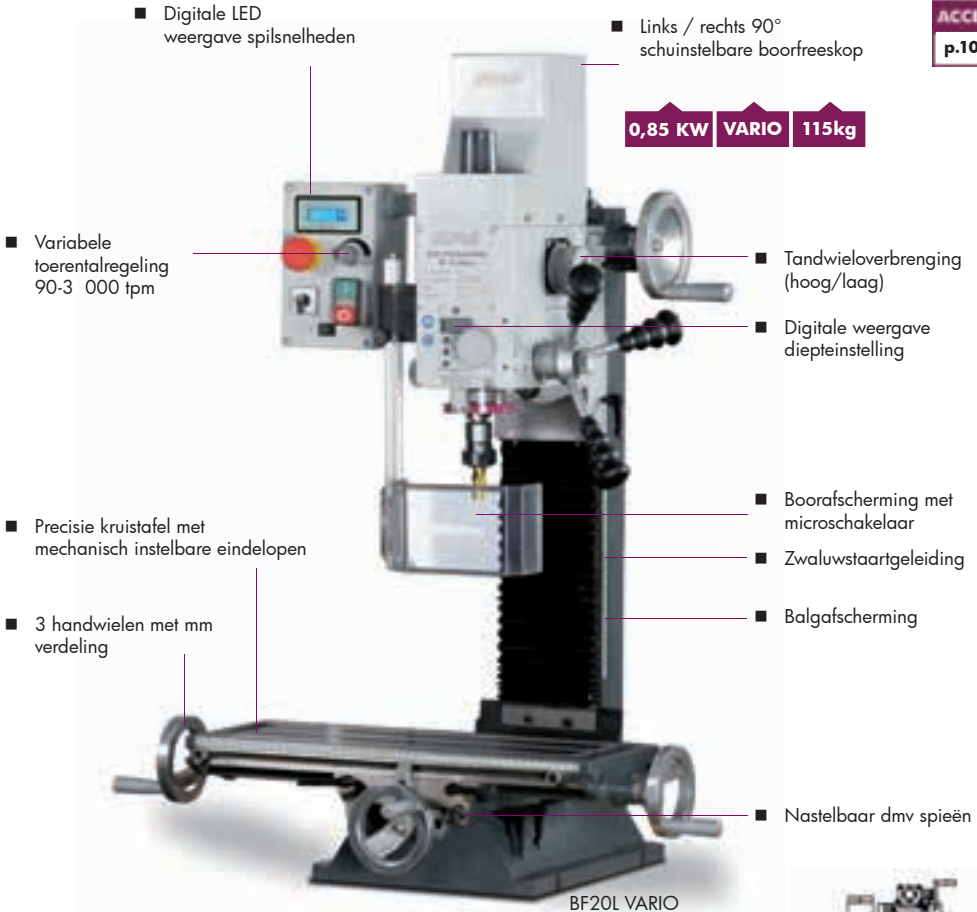

■ Optionele machinevoet



Order nr.	713353003	
Orig. nr.	FS1	
Gewicht	kg	45,00
Afm. (l x b x h)	mm	920 x 440 x 525
Prijs	€	299,00

BEKIJK DE VIDEO



VERPL.

X: 480mm
Y: 175mm
Z: 370mm

Standaard geleverd met :

- Aantrekstang M10
- Bedieningsleutels
- Nederlandstalige handleiding, opschriften, CE - kenmerk, en CE-attest volgens Machine richtlijn 2006/42/CE, Laagspanningsrichtlijn 2006/95/CE en EMC Richtlijn 2004/108/CE



Stabiele boorfreesmachine met elektronische toerental regeling met digitale weergave.

- Boorfreesmachine met 2-traps tandwieloverbrenging, hoog en laag.
- Stille krachtige elektromotor van 1100 Watt. Gelijkstroom motor met permanente toerentalbewaking.
- EMV filter (bescherming tegen mogelijke elektrische storingen)
- Interne elektriciteit werkt met 24 Volt i.p.v. 230 Volt.
- Opname MK3 met draadopname M12
- Met traploos regelbare aandrijving 100 – 2.500 tpm
- Boorfreeskop is langs beide zijden onder hoek instelbaar +/- 90°, maakt de meeste frees- en boorbewerkingen onder iedere hoek mogelijk.
- Boorfreeskop is in de hoogte verstelbaar.
- Kolom is langs beide zijden 30 mm verplaatsbaar, daardoor ook met onder hoek geplaatste boorfreeskop een langere verplaatsing en centrische bewerking van het werkstuk op de kruistafel mogelijk.
- Eenvoudige bediening vooraan met aparte start/stop drukknop en aparte noodstop.
- Keuzeschakelaar links - rechtsdraaiend
- Start / stop verbinding voorzien om optionele CNC sturing aan te sluiten
- Stervormige handgreep met ijzeren handvatten.
- Digitale LED weergave van de spilsnelheden
- Vastzetten van alle rijwegen mogelijk en alle verplaatsingen zijn met een schaal aanduiding uitgerust
- Digitale weergave van de diepte instelling, omschakelen tussen mm/inch en afleesbaarheid van 0,01 mm
- Precieze omloopnauwkeurigheid door kogellagers beter dan 0,015 mm in de spil gemeten
- Stabiele en precieze zwaluwstaartuitvoering met regelbare spie-geleiders op de 3 assen
- Massieve en precies geslepen kruistafel met T-gleuven en koelmiddelrand. Langsverplaatsing voorzien van mechanisch instelbare eindeloop schakelaars.
- Boorafscherming voorzien van een microscharakelaar, bij het openen valt de machine stil.

Order nr.	713338130 	
Orig. nr.		MH28V
Spanning	V	1x230
Vermogen motor	kW	1,1
Boorcapaciteit in staal S235JR	mm	20
Maximum freescapaciteit vlakfrees	mm	70
Maximum freescapaciteit vingerfrees	mm	28
Spilopname	MK	3/M12
Uitlading	mm	-
Boordiepte	mm	70
Kop zwenkbaar	°	+/-90
Aantal snelheden		2
Spindeltoerental	min-1	100-2500
Rijweg X-as	mm	440
Rijweg Y-as	mm	190
Rijweg Z-as	mm	380
Afmetingen tafel (b x d)	mm	730x210
Afmetingen T-groeven/alstand	mm	14
Gewicht	kg	205,00
Afmetingen (l x b x h)	mm	870 x 630 x 1000
Prijs	€	1.959,00

MH28V

MK3/M12

ACCESSOIRES

p.1012-1091

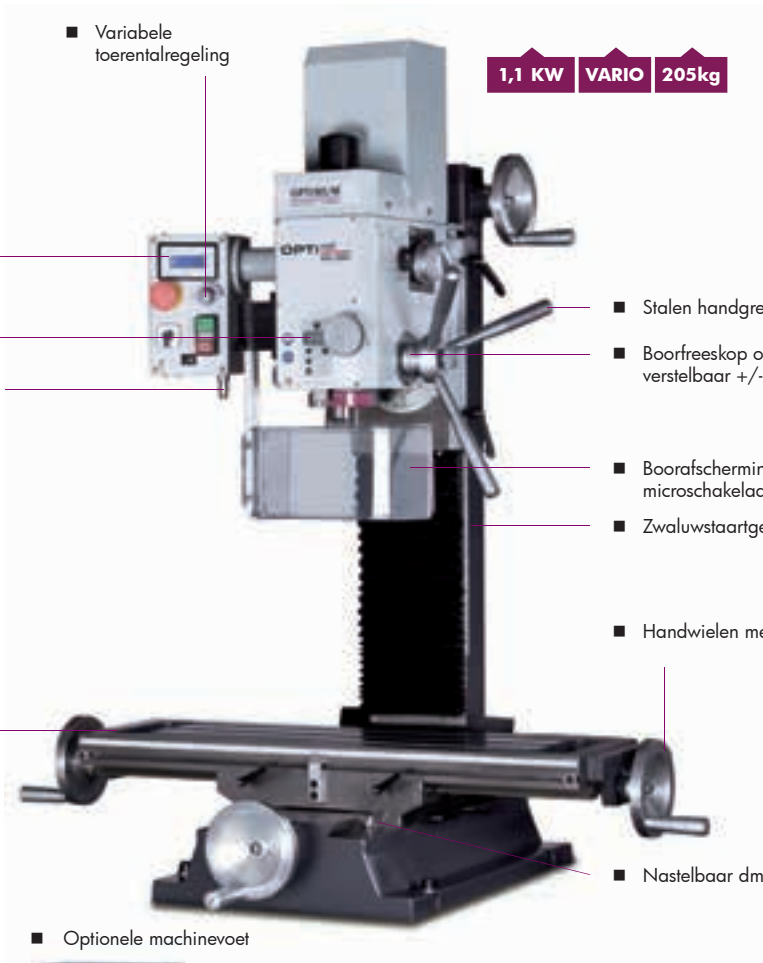

1,1 KW VARIO 205kg

- Variabele toerentalregeling
- Digitale weergave spijnsnelheden
- Digitale weergave diepteinstelling
- Start-stop verbinding
- Stalen handgreep
- Boor-freeskop onder hoek verstelbaar +/- 90°
- Booraafscherming met microscharakelaar
- Zwaluwstaartgeleiding
- Handwielen met mm schaal
- Precisie geslepen kruistafel
- Nastelbaar dmv spieën
- Optionele machinevoet

VERPL.
X: 440mm
Y: 190mm
Z: 380mm

Order nr.	713353006	M
Orig. nr.	FS3	
Gewicht	kg	54,00
Afm. (l x b x h)	mm	625 x 415 x 750
Prijs	€	269,00

Standaard geleverd met :

- Aantrekstang M10
- Bedieningsleutels
- Nederlandstalige handleiding, opschriften, CE - kenmerk, en CE-attest volgens Machine richtlijn 2006/42/CE, Laagspanningsrichtlijn 2006/95/CE en EMC Richtlijn 2004/108/CE

MACHINES



Universele boorfreesmachine met tandwieloverbrenging en 12 spilsnelheden.

- Boorfreesmachine met tandwieloverbrenging constant gesmeerd in een oliebad.
- Krachtige tweesnelheid motor 1,1 / 1,5 kW.
- Opname MK4 met draadopname M16
- Breed gamma toerentalbereik 95 – 3.200 tpm
- Boorfreeskop is langs beide zijden onder hoek instelbaar +/- 60°, maakt de meeste frees- en boorbewerkingen onder iedere hoek mogelijk.
- Boorfreeskop is in de hoogte verstelbaar.
- Hoge rondlooptrouwbaarheid door geslepen spindel.
- Eenvoudige bediening vooraan met aparte start/stop drukknop en aparte noodstop.
- Keuzeschakelaar links - rechtsdraaiend
- Gegoten stervormige handgreep.
- Vastzetten van alle rijwegen mogelijk en alle verplaatsingen zijn met een schaal aanduiding uitgerust
- Stabiele en precieze zwaluwstaartuitvoering met regelbare spie-geleiders op de 3 assen
- Massieve en precies geslepen kruistafel met T-gleuven en koelmiddelrand. Langsverplaatsing voorzien van mechanisch instelbare eindeloop schakelaars.
- Boorafscherming voorzien van een microschatelaar, bij het openen valt de machine stil.

Order nr. 713338450

Orig. nr.		MB4
Spanning	V	3x400
Vermogen motor	kW	1,1/1,5
Boorcapaciteit in staal S235JR	mm	32
Boorcapaciteit bij continu gebruik S235JR	mm	28
Maximum freescapaciteit vlakfrees	mm	63
Maximum freescapaciteit vingerfrees	mm	28
Spilopname	MK	4/M16
Uitlading	mm	275
Boordiepte	mm	120
Kop zwenkbaar	°	+/-60
Aantal snelheden		2x6
Spindeltoerental	min-1	95-3.200
Rijweg X-as	mm	450
Rijweg Y-as	mm	200
Rijweg Z-as	mm	430
Afmetingen tafel (b x d)	mm	800x240
Afmetingen T-groeven/afstand	mm	14/63
Gewicht	kg	320,00
Afmetingen (l x b x h)	mm	760 x 850 x 1150
Prijs	€	2.090,00

MB4

MK4/M16

ACCESSOIRES

p.1012-1091

1,1/1,5 KW 320kg

- Bedieningspaneel
- Links/rechts schakelaar
- Aparte noodstop
- Tweesnelheidsmotor 1,1/1,5kW
- Keuzeschakelaars voor snelheidswisseling
- Fijne manuele voeding
- Stalen handgrepen
- Zwaluwstaartgeleiding
- Z verplaatsing dmv hendel
- Precise kruistafel met afstelbare v-spieën

- Optionele machinevoet

Order nr.	713353006 	
Orig. nr.	FS3	
Gewicht	kg	54,00
Afm. (l x b x h)	mm	625 x 415 x 750
Prijs	€	269,00

VERPL. 

X: 450mm
Y: 200mm
Z: 430mm

Standaard geleverd met :

- Aantrekstang M12
- Bedieningsleutels
- Sokkel niet inbegrepen
- Nederlandstalige handleiding, opschriften, CE - kenmerk, en CE-attest volgens Machine richtlijn 2006/42/CE, Laagspanningsrichtlijn 2006/95/CE en EMC Richtlijn 2004/108/CE



OPTI

Universele boorfreesmachine met boorvoeding, digitale aflezing, onderstel en automatische langsvoeding.

- Boorfreesmachine met tandwieloverbrenging constant gesmeerd in een oliebad.

- Krachtige tweesnelheid motor 1,1 / 1,5 kW.

- Opname MK4 met draadopname M16

- Breed gamma toerentalbereik 75 – 3.200 tpm

- Boorfreeskop is langs beide zijden onder hoek instelbaar +/- 60°, maakt de meeste frees- en boorbewerkingen onder iedere hoek mogelijk.

- Gemotoriseerde Z hoogteverplaatsing van de boorfreeskop.

- Hoge rondlooptrouwkeurigheid door geslepen spindel.

- Geïntegreerde bediening met aparte start/stop drukknop en aparte noodstop, links-rechtsdraaiend, koeling aan-uit, tapfunctie en digitale aflezing op 3 assen.

- Pendelarm kan zowel links als rechts geplaatst worden

- Digitale aflezing van de waarden gebeurt over magneetbanden.

- Boorvoeding d.m.v. inschakelen handgreep.

- Automatische elektronische langsvoeding

- Gesloten koelvloeistofsysteem met koelpomp

- Robuuste gietijzere onderstel

- Vastzetten van alle rijwegen mogelijk en alle verplaatsingen zijn met een schaal aanduiding uitgerust

- Stabiele en precieze zwaluwstaartuitvoering met regelbare spie-geleiders op de 3 assen

- Massieve en precies geslepen kruistafel met T-gleuven en koelmiddelrand. Langsverplaatsing voorzien van mechanisch instelbare eindeloop schakelaars.

- Booraafscherming voorzien van een microschakelaar, bij het openen valt de machine stil.

Order nr.	713338460 	
Orig. nr.		MB4P
Spanning	V	3x400
Vermogen motor	kW	1,1/1,5
Boorcapaciteit in staal S235JR	mm	32
Boorcapaciteit bij continu gebruik S235JR	mm	28
Maximum freescapaciteit vlakfrees	mm	63
Maximum freescapaciteit vingerfrees	mm	28
Spilopname	MK	4/M16
Uitlading	mm	280
Boordiepte	mm	120
Kop zwenkbaar	°	+/-60
Aantal snelheden		2x6
Spindeltoerental	min-1	95-3200
Rijweg X-as automatisch	mm	560
Rijweg Y-as	mm	230
Rijweg Z-as	mm	350
Afmetingen tafel (b x d)	mm	800x240
Afmetingen T-groeven/afstand	mm	14/80/3
Gewicht	kg	515,00
Afmetingen (l x b x h)	mm	1000 x 1300 x 2220
Prijs	€	4.990,00

MB4P

MK4/M16

NEW

ACCESSOIRES

p.1012-1091



■ Gemotoriseerde Z verplaatsing

■ Ergonomisch bedieningspaneel met geïntegreerde digitale aflezing (op 3 assen)



1,1/1,5 KW 515kg

■ Tweesnelheidsmotor 1,1/1,5kW

■ Tandwieloverbrenging

■ Automatische boorvoeding met 3 boorvoedingen

■ Geïntegreerd tapfunctie

■ Boorfreeskop +/- 60° vestelbaar

■ Koelvloeistofinrichting

■ Zwaluwstaartgeleiding

■ Booraafscherming met microscharnelaar

■ Automatische elektrische langvoeding

■ Overzichtelijke elektrische kast



■ Inclusief machinevoet

■ Koelpomp



VERPL.

**X: 560mm
Y: 230mm
Z: 350mm**

Standaard geleverd met :

- Machinevoet
- Digitale aflezing op 3 assen
- Langvoeding
- Koelvloeistofsysteem
- Gemotoriseerde boorfreeskop
- Aantrekstang M16
- Bedieningsleutels
- Nederlandstalige handleiding, opschriften, CE - kenmerk, en CE-attest volgens Machine richtlijn 2006/42/CE, Laagspanningsrichtlijn 2006/95/CE en EMC Richtlijn 2004/108/CE.



Universele precisie boorfreesmachine met tandwieloverbrenging.

- Tandwielen en assen zijn gehard en geslepen en gesmeerd in een oliebad.
- Stille krachtige tweesnelheid elektromotor van 1.100 / 1.500 Watt.
- Opname MK3/M12
- Boorfreeskop is langs beide zijden onder hoek instelbaar +/- 60°, maakt de meeste frees- en boorbewerkingen onder iedere hoek mogelijk.
- Boorfreeskop is in de hoogte verstelbaar.
- Eenvoudige bediening vooraan met aparte start/stop drukknop en aparte noodstop.
- Handwiel voor fijne voeding
- Zware, massieve gietijzeren uitvoering 350 kg.
- Metalen zaluwstaartbescherming voor de Zas
- Stalen stervormige handgreep uit 3 stukken.
- Vastzetten van alle rijwegen mogelijk en alle verplaatsingen zijn met een schaal aanduiding uitgerust
- Massieve en precieze zwaluwstaartuitvoering met regelbare spie-geleiders op de 3 assen
- Massieve en precies geslepen kruistafel met T-gleuven en koelmiddelrand. Langsverplaatsing voorzien van mechanisch instelbare eindeloop schakelaars.
- Boorafscherming voorzien van een microscharakelaar, bij het openen valt de machine stil.
- Keuzeschakelaar links - rechtsdraaiend
- Op aanvraag leverbaar in 3x220V/50Hz en 3x440V/60Hz

Opmerking: 3x220V = krachtstroom (drijfkracht). Dit is niet hetzelfde als 1x230V mono = wisselstroom

Order nr.	713338440	
Orig. nr.		F40E
Spanning	V	3x400
Vermogen motor	kW	1,1/1,5
Boorcapaciteit in staal S235JR	mm	32
Boorcapaciteit bij continu gebruik S235JR	mm	28
Maximum freescapaciteit vlakfrees	mm	63
Maximum freescapaciteit vingerfrees	mm	28
Spilopname	MK	3/M12
Uitlading	mm	265
Boordiepte	mm	120
Kop zwenkbaar	°	+/- 60
Aantal snelheden		2x6
Spindeltoerental	min-1	95-3200
Rijweg X-as	mm	450
Rijweg Y-as	mm	200
Rijweg Zas	mm	480
Afmetingen tafel (b x d)	mm	750x210
Afmetingen T-groeven/alstand	mm	12/63
Gewicht	kg	350,00
Afmetingen (l x b x h)	mm	1075 x 795 x 1365
Prijs	€	2.590,00

F40E

MK3/M12

ACCESSOIRES

p.1012-1091

1,1/1,5 KW 350kg

■ Aparte start / stopknop / noodstop

■ Boorafscherming met microscharelaar

■ Metalen afscherming van de kolom

■ Precisie kruistafel met mechanisch instelbare eindelopen

■ Snelheidshendels vooraan

■ Tandwielen in een oliebad gesmeerd

■ Fijnregeling boordiepte

■ Schuinstelbare boor-freeskop 60°

■ Spindelblokkering

■ Manuele verplaatsing dmv hendel

■ Handwielen met mm schaal

■ Optionele machinevoet



VERPL.

X: 450mm
Y: 200mm
Z: 430mm

Order nr.	713353004	M
Orig. nr.	FS5	
Gewicht	kg	85,00
Afm. (l x b x h)	mm	760 x 650 x 935
Prijs	€	569,00

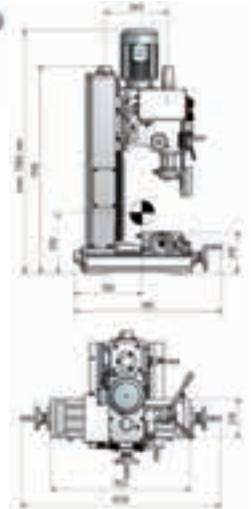

Standaard geleverd met :

- Aantrekstang M12
- Bedieningslevtels
- Nederlandstalige handleiding, opschriften, CE - kenmerk, en CE-attest volgens Machine richtlijn 2006/42/CE, Laagspanningsrichtlijn 2006/95/CE en EMC Richtlijn 2004/108/CE



Precieze boorfreesmachine met elektronische toerental regeling met digitale weergave.

- Boorfreesmachine met 3-traps tandwieloverbrenging, hoog-midden-laag.
- Tandwielen en assen zijn gehard en geslepen en gesmeerd in een oliebad.
- Stille krachtige elektromotor van 2.200 Watt. Gelijkstroom motor met permanente toerentalbewaking.
- Opname MK3 met draadopname M12 of opname ISO30 DIN2080
- Met traploos regelbare aandrijving 80 – 3.100 tpm
- Boorfreeskop is langs beide zijden onder hoek instelbaar +/- 90°, maakt de meeste frees- en boorbewerkingen onder iedere hoek mogelijk.
- Boorfreeskop is in de hoogte verstelbaar.
- Eenvoudige bediening vooraan met aparte start/stop drukknop en aparte noodstop.
- Keuzeschakelaar links – rechtsdraaiend
- Zware, massieve gietijzeren uitvoering 265 kg.
- Metalen zaluwstaartbescherming voor de Z-as
- Stalen stervormige handgreep uit 3 stukken.
- Digitale LED weergave van de spilsnelheden
- Vastzetten van alle rijwegen mogelijk en alle verplaatsingen zijn met een schaal aanduiding uitgerust
- Digitale weergave van de diepte instelling, omschakelen tussen mm/inch en afleesbaarheid van 0,01 mm
- Precieze omlooppauwkeurigheid door kogellagers beter dan 0,015 mm in de spil gemeten, spildiameter 70 mm
- Massieve en precieze zwaluwstaartuitvoering met regelbare spie-geleiders op de 3 assen
- Massieve en precies geslepen kruistafel met T-gleuven en koelmiddelrand. Langsverplaatsing voorzien van mechanisch instelbare eindeloop schakelaars.
- Boorafscherming voorzien van een microscharakelaar, bij het openen valt de machine stil.
- Keuzeschakelaar 4 standen:
 - linksdraaiend
 - rechtdraaiend
 - Auto ON/OFF (automatisch spindel activatie bij het trekken aan de hendel en uitschakeling bij het loslaten)
- Tapfunctie (rechtsdraaiend tot op een bepaalde vooraf ingestelde diepte om vervolgens automatisch linksdraaiend terug te keren).

Order nr.		713338430 ^M	713338431 ^M
Orig. nr.		BF30-MK VARIO	BF30-ISO VARIO
Spanning	V	1x230	1x230
Vermogen motor	kW	2,2	2,2
Boorcapaciteit in staal S235JR	mm	24	24
Boorcapaciteit bij continu gebruik S235JR	mm	20	20
Maximum freescapaciteit vlakfrees	mm	75	75
Maximum freescapaciteit vingerfrees	mm	30	30
Spilopname	MK	3/M12	
Spilopname	ISO		30 DIN2080
Uitlading	mm	220	220
Boordiepte	mm	90	90
Kop zwenkbaar	°	+/- 90	+/- 90
Aantal snelheden		3 (traploos)	3 (traploos)
Spindeltoeren langzaam	min-1	80-1100	80-1100
Spindeltoeren gemiddeld	min-1	160-1700	160-1700
Spindeltoeren snel	min-1	320-3100	320-3100
Rijweg X-as	mm	450	450
Rijweg Y-as	mm	200	200
Rijweg Z-as	mm	470	470
Afmetingen tafel (b x d)	mm	750x210	750x210
Afmetingen T-groeven/afstand	mm	12/63	12/63
Gewicht	kg	272,00	272,00
Afmetingen (l x b x h)	mm	1073 x 792 x 1245	1073 x 792 x 1245
Prijs	€	3.390,00	3.390,00

BF30VARIO

MK3/M12

ISO 30

ACCESSOIRES

p.1012-1091

2,2KW VARIO 272kg

- Digitale LED weergave spissnelheden
- Auto functie Tap functie
- Digitale weergave diepteinstelling
- Spindelblokkering
- Precisie geslepen kruistafel
- Tandwieloverbrenging (hoog/midden/laag)
- Tandwielen in een oliebad gesmeerd
- Fijne manuele boorvoeding
- Links / rechts 90° schuinstelbare kop
- Boorafscherming met microscharakelaar
- Metalen balgafscherming
- Optionele machinevoet

Order nr.	713353004
Orig. nr.	FS5
Gewicht	kg 85,00
Afm. (l x b x h)	mm 760 x 650 x 935
Prijs	€ 569,00

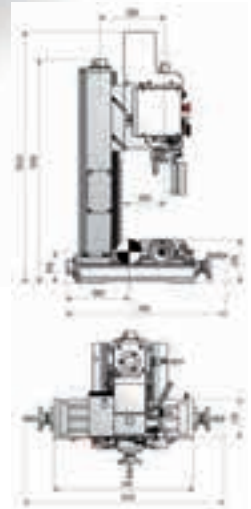

VERPL.

X: 450mm
Y: 200mm
Z: 430mm

Standaard geleverd met :

- Aantrekstang M12
- Bedieningsleutels
- Sokkel niet inbegrepen
- Nederlandstalige handleiding, opschriften, CE - kenmerk, en CE-attest volgens Machine richtlijn 2006/42/CE, Laagspanningsrichtlijn 2006/95/CE en EMC Richtlijn 2004/108/CE - Sokkel niet inbegrepen



Universele, massieve boorfreesmachine voor de veeleisende gebruiker en professionals.

- Massieve zwaluwstaartgeleiding van de tandwielenkop zorgt voor de hoogste stabiliteit en grootst mogelijke precisie
- Boorfreesmachine met 3-traps tandwieloverbrenging, hoog-midden-laag.
- Tandwielen en assen zijn gehard en geslepen en gesmeerd in een oliebad.
- Stille krachtige elektromotor van 2.200 Watt. Gelijktroom motor met permanente toerentalbewaking.
- Opname ISO40 DIN2080
- Met traploos regelbare aandrijving 115 – 3.100 tpm
- Boorfreeskop is langs beide zijden onder hoek instelbaar +/- 90°, maakt de meeste frees- en boorbewerkingen onder iedere hoek mogelijk.
- Boorfreeskop is in de hoogte verstelbaar.
- Eenvoudige bediening vooraan met aparte start/stop drukknop en aparte noodstop.
- Zware, massieve gietijzeren uitvoering 480 kg.
- Metalen zalwstaartbescherming voor de Zas
- Stalen stervormige handgreep uit 3 stukken.
- Digitale LED weergave van de spilsnelheden
- Vastzetten van alle rijwegen mogelijk en alle verplaatsingen zijn met een schaal aanduiding uitgerust
- Centrale smering voor spindel, moeren en geleidingen
- Digitale weergave van de diepte instelling, omschakelen tussen mm/inch en afleesbaarheid van 0,01 mm
- Precieze omloopnauwkeurigheid door kogellagers beter dan 0,015 mm in de spil gemeten
- Massieve en precieze zwaluwstaartuitvoering met regelbare spie-geleiders op de 3 assen
- Massieve en precies geslepen kruisafstand met T-gleuven en koelmiddelrand. Langsverplaatsing voorzien van mechanisch instelbare eindeloop schakelaars.
- Boorafscherming voorzien van een microschaakelaar, bij het openen valt de machine stil.
- BF46 Vario werd fabrieksklaar CNC voorbereid (speciale spindelaggers en montagegemakelijkheid Y as behuizing achteraan de zuil.
- Keuzeschakelaar 4 standen:
 - linksdraaiend
 - rechtsdraaiend
 - Auto ON/OFF (automatisch spindel activatie bij het trekken aan de hendel en uitschakeling bij het loslaten)
- tapfunctie (rechtsdraaiend tot op een bepaalde vooraf ingestelde diepte om vervolgens automatisch linksdraaiend terug te keren).
- Ook leverbaar met een pneumatische gereedschapswisselaar, artikel 71 3338456, BF46TC Vario.
- Optioneel kan eveneens voor MK4/M16 of ISO40 DIN69871 spindel gekozen worden.
- Sokkel niet inbegrepen

Order nr.

713338453

Orig. nr.		BF46 VARIO
Spanning	V	1x230
Vermogen motor	kW	2,2
Boorcapaciteit in staal S235JR	mm	28
Boorcapaciteit bij continu gebruik S235JR	mm	24
Maximum freescapaciteit vlakfrees	mm	80
Maximum freescapaciteit vingerfrees	mm	32
Spilopname	ISO	40 DIN2080
Uitlading	mm	260
Boordiepte	mm	115
Kop zwenkbaar	°	+/- 90
Aantal snelheden		3 (vario)
Spindeltoeren langzaam	min-1	115-600
Spindeltoeren gemiddeld	min-1	270-1400
Spindeltoeren snel	min-1	590-3100
Rijweg X-as	mm	500
Rijweg Y-as	mm	250
Rijweg Zas	mm	541
Afmetingen tafel (b x d)	mm	850x240
Afmetingen T-groeven/afstand	mm	18-80
Gewicht	kg	445,00
Afmetingen (l x b x h)	mm	1210 x 950 x 1520
Prijs	€	4.590,00

BF46VARIO

ISO 40

ACCESSOIRES

p.1012-1091

2,2KW VARIO 445kg

- Digitale LED weergave spijlsnelheden
- Auto & tap functie
- Digitale weergave diepteinstelling
- Spantangenhouder in optie
- Centrale smering
- Optionele freesklem
- Tandwieloverbrenging (hoog/midden/laag)
- Tandwielen in een oliebad gesmeerd
- Links / rechts 90° schuinstelbare kop
- Boorafscherming met microscharakelaar
- Precisie kruistafel met mechanisch instelbare eindlopen
- Optionele machinevoet

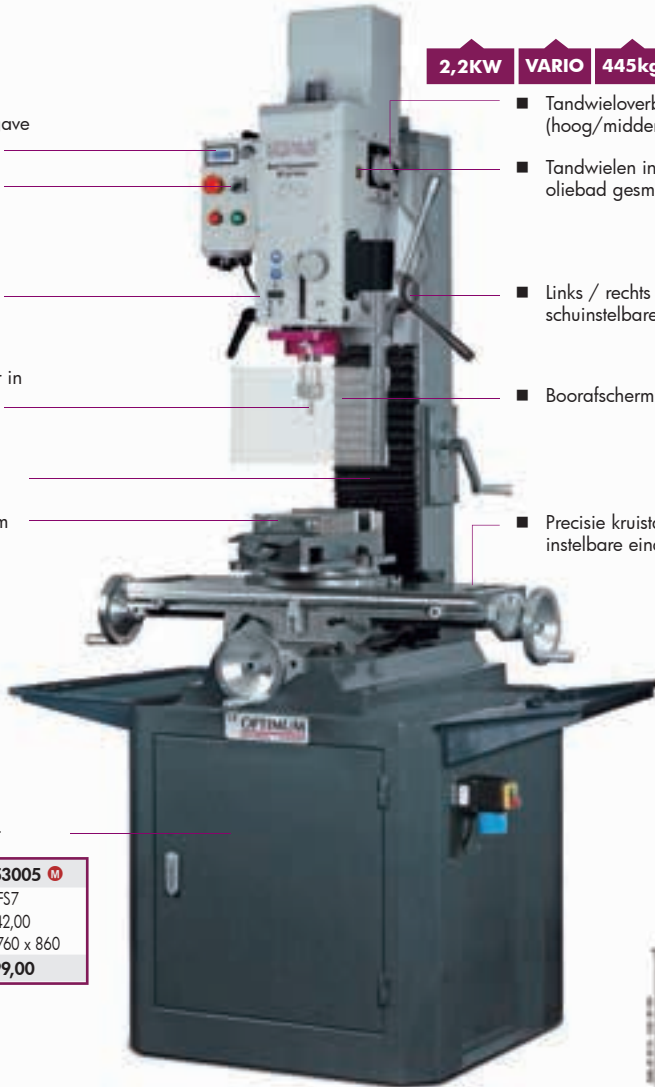

Order nr.	713353005 	
Orig. nr.	FS7	
Gewicht	kg	142,00
Afm. (l x b x h)	mm	760 x 760 x 860
Prijs	€	899,00

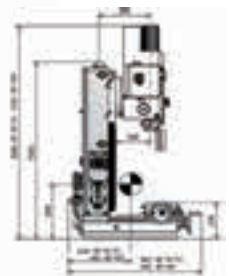

VERPL. 

X: 500mm
Y: 250mm
Z: 541mm

Standaard geleverd met :

- Aantrekstang M16
- Bedieningsleutels
- Sokkel niet inbegrepen
- Nederlandstalige handleiding, opschriften, CE - kenmerk, en CE-attest volgens Machine richtlijn 2006/42/CE, Laagspanningsrichtlijn 2006/95/CE en EMC Richtlijn 2004/108/CE



Universele, massieve boorfreesmachine voor de veeleisende gebruiker en professionals met pneumatische gereedschapsaantrekker en **gemotoriseerde Z verplaatsing**.

- Massieve zwaluwstaartgeleiding van de tandwielenkop zorgt voor de hoogste stabiliteit en grootst mogelijke precisie
- Boorfreesmachine met 3-traps tandwieloverbrenging, hoog-midden-laag.
- Tandwielen en assen zijn gehard en geslepen en gesmeerd in een oliebad.
- Stille krachtige elektromotor van 2.200 Watt. Gelijkstroom motor met permanente toerentalbewaking.
- Opname ISO40 DIN2080
- Met traploos regelbare aandrijving 115 – 3.100 tpm
- Boorfreeskop is langs beide zijden onder hoek instelbaar +/- 90°, maakt de meeste frees- en boorbewerkingen onder iedere hoek mogelijk.
- Boorfreeskop is in de hoogte verstelbaar.
- Eenvoudige bediening vooraan met aparte start/stop drukknop en aparte noodstop.
- Zware, massieve gietijzeren uitvoering 480 kg.
- Metalen zaluwstaartbescherming voor de Zas
- Stalen stervormige handgreep uit 3 stukken.
- Digitale LED weergave van de spilsnelheden
- Vastzetten van alle rijwegen mogelijk en alle verplaatsingen zijn met een schaal aanduiding uitgerust
- Centrale smering voor spindel, moeren en geleidingen
- Digitale weergave van de diepte instelling, omschakelen tussen mm/inch en afleesbaarheid van 0,01 mm
- Precieze omloopnauwkeurigheid door kogellagers beter dan 0,015 mm in de spil gemeten
- Massieve en precieze zwaluwstaartuitvoering met regelbare spie-geleiders op de 3 assen - Massieve en precies geslepen kruistafel met T-gleuven en koelmiddelrand. Langsverplaatsing voorzien van mechanisch instelbare eindeloop schakelaars.
- Boorafscherming voorzien van een microscharakelaar, bij het openen valt de machine stil. - Geïntegreerde halogeenverlichting 12V, 10W
- BF46 Vario werd fabrieksklaar CNC voorbereid (speciale spindellagers en montagegemakelijkheid Y as behuizing achteraan de zuil.
- Keuzeschakelaar 4 standen: - linksdraaiend - rechtdraaiend - Auto ON/OFF (automatisch spindel activatie bij het trekken aan de hendel en uitschakeling bij het loslaten) - tapfunctie (rechtsdraaiend tot op een bepaalde vooraf ingestelde diepte om vervolgens automatisch linksdraaiend terug te keren).
- **Met een pneumatische gereedschapswisselaar.**
- Optioneel kan eveneens voor MK4/M16 of ISO40 DIN69871 spindel gekozen worden.
- Sokkel niet inbegrepen

Order nr.	713338456	
Orig. nr.	BF46TC VARIO	
Spanning	V	1x230
Vermogen motor	kW	2,2
Boorcapaciteit in staal S235JR	mm	24
Boorcapaciteit bij continu gebruik S235JR	mm	24
Maximum freescapaciteit vlakfrees	mm	80
Maximum freescapaciteit vingerfrees	mm	32
Spilopname	ISO	40 DIN2080
Uitlading	mm	260
Boordiepte	mm	115
Kop zwenkbaar	°	+/- 90
Aantal snelheden		3 (vario)
Spindeltoeren langzaam	min-1	115-600
Spindeltoeren gemiddeld	min-1	270-1400
Spindeltoeren snel	min-1	590-3100
Rijweg X-as	mm	500
Rijweg Y-as	mm	250
Rijweg Zas	mm	541
Afmetingen tafel (b x d)	mm	850x240
Afmetingen T-groeven/alstand	mm	18-80
Gewicht	kg	480,00
Afmetingen (l x b x h)	mm	1210 x 950 x 1520
Prijs	€	5.690,00

BF46TC

ISO 40

NEW

2,2KW VARIO 480kg

ACCESSOIRES

p.1012-1091

■ Variabele toerentalregeling

■ Pneumatische gereedschapsaantrekker

■ Digitale LED weergave spijlsnelheden

■ Tandwieloverbrenging (hoog/midden/laag)

■ Auto & tap functie

■ Tandwielen in een oliebad gesmeerd

■ Digitale weergave diepteinstelling

■ Links / rechts 90° schuinstelbare spijl

■ Gemotoriseerde Z verplaatsing

■ Metalenbalgbescherming Z as

■ Centrale smering voor alle geleidingen

■ Precisie kruistafel met mechanisch instelbare eindlopen

■ Nastelbaar dmv spieën

■ Optionele machinevoet

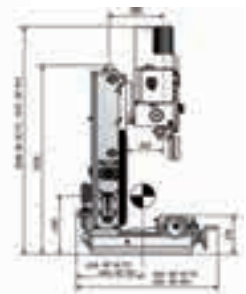

VERPL.

X: 500mm
Y: 250mm
Z: 541mm

Order nr.	713353005	
Orig. nr.	FS7	
Gewicht	kg	142,00
Afm. (l x b x h)	mm	760 x 760 x 860
Prijs	€	899,00

Standaard geleverd met :

- Aantrekstang M16
- Bedieningsleutels
- Zonder sokkel
- Nederlandstalige handleiding, opschriften, CE kenmerk, en CE-attest volgens Machine richtlijn 2006/42/CE, Laagspanningsrichtlijn 2006/95/CE en EMC Richtlijn 2004/108/CE

OPTIMUM



Machinevoet. Voor freesmachines BF16, BF20 en BF20L met afsluitbare opbergkast, inlegplank en opvangtafel voor koelmiddel.

Order nr.	713353003	
Orig. nr.	FS1	
Gewicht	kg	35,00
Afmetingen (l x b x h)	mm	500 x 420 x 800
Prijs	€	299,00

OPTIMUM



Machinevoet met opbergruimte en spanenopvangplaat voor MB4 en MH28V.

Order nr.	713353006	
Orig. nr.	FS3	
Gewicht	kg	54,00
Afmetingen (l x b x h)	mm	625 x 415 x 750
Prijs	€	269,00

OPTIMUM



Machinevoet met afsluitbare opbergkast voor freesmachines BF30 Vario en F40E. Zijdlinkse opvangplaten. Massief en zwaargebouwd om stabiliteit te garanderen.

Order nr.	713353004	
Orig. nr.	FS5	
Gewicht	kg	85,00
Afmetingen (l x b x h)	mm	760 x 650 x 935
Prijs	€	569,00







OPTIMUM



Machinevoet met afsluitbare opbergkast voor freesmachines BF46 Vario. Zijdlinkse opvangplaten. Massief en zwaargebouwd om stabiliteit te garanderen.

Order nr.	713353005	
Orig. nr.	FS7	
Gewicht	kg	142,00
Afmetingen (l x b x h)	mm	1234 x 750 x 884
Prijs	€	899,00

KIES UW FREESKLEM

	Ordernr.	BF16VARIO	BF20Q1VARIO	MH28V	FA0E	MB4	MB 4P	BF30 VARIO	BF40VARIO	MT50	MF2VARIO	MF4VARIO	MT100	MT200	MB	MX2	MX3	MX4
Mechanische klem																		
 FMS	FMS100	713354100	●	●	●	●	●	●	●	●	●	●	●	●	●	●	●	●
	FMS125	713354125		●	●	●	●	●	●	●	●	●	●	●	●	●	●	●
	FMS150	713354150			●			●	●	●		●		●	●	●	●	●
	FMS200	713354200												●	●	●	●	●
Mechanische precisie klem																		
 FMSN	FMSN100	713354110		●	●	●	●	●	●	●	●	●	●	●	●	●	●	●
	FMSN125	713354120			●	●	●	●	●	●	●	●	●	●	●	●	●	●
	FMSN150	713354130										●		●	●	●	●	●
Hydraulische klem																		
 HMS	HMS100	713355100			●	●	●	●	●	●	●	●	●	●	●	●	●	●
	HMS125	713355127			●	●	●	●	●	●	●	●	●	●	●	●	●	●
	HMS150	713355150								●		●		●	●	●	●	●
	HMS200	713355200												●	●			●
3-assige klem																		
 DAS	DAS100	713355500	●	●	●	●	●	●	●	●	●	●	●	●	●	●	●	●
3-assige klem																		
 MV3	MV3-75	713354175	●	●	●	●	●	●	●	●	●		●			●	●	●
	MV3-125	713354178		●	●	●	●	●	●	●	●		●			●	●	●
2-assige klem																		
 ZAS50	ZAS50	713354170	●	●	●	●	●	●	●	●	●		●			●	●	●
Zelfcentrerende klem																		
 MVC	MVC160	713354214			●	●	●	●	●	●	●	●		●	●	●	●	●
	MVC200	713354220												●	●	●	●	●
	MVC250	713354225												●	●			●

● aanbevelen



Torenfreesmachines



Stabiele torenfreesmachines met frequentiesturing LENZE "Made in EU" voor de professionele gebruiker en algemene industrie.

- Kwaliteitsfreesmachine met frequentiegestuurde spijlsnelheden (LENZE) met een heel groot bereik.
- Spijsnelheden 10 - 5.100 tpm.
- Door groot bereik inzetbaar op tal van ferro en non-ferro materialen
- Hoge rondloop nauwkeurigheid door precisie kogellagers beter dan 0,01 mm
- Zware, massieve uitvoering uit hoogwaardig Meehanite gietijzer
- Alle assen (X, Y en Z) voorzien van precisie geslepen zwaluwstaartgeleidingen
- Centrale smering van de geleidingen
- Stabiele kruistafel met geslepen T-gleuven en voorzien van een koelrand.
- Boorvoeding op de spil met boordiepte aanslag, afleesbaar langs de voorzijde en met mm schaalverdeling
- Spil is eveneens voorzien van een rem
- Freeskop is links/rechts onder hoek verstelbaar en is ook naar voren en naar achteren kantelbaar.
- Massieve freesram kan eveneens naar voren en naar achteren zich verplaatsen
- Degelijke rubberen afscherming voor de zwaluwstaartgeleidingen
- Digitale uitlezing DPA2000 op 3 assen gemonteerd met precisie glasmeetlinialen.
- Elektronische automatische langvoeding op de X-assen, bekabeling mooi weggewerkt in een beschermingskabel
- Manuele hoogteverstelling
- Ergonomisch, zwenkbaar en gebruiksvriendelijk bedieningspaneel op pendelarm
- Hoofdschakelaar met motorbeveiliging, aparte start/stop knop, aparte noodstop, potentiometer voor de regeling van de snelheden.
- Gesloten koelvoelstofsysteem met koelpomp
- Degelijke spanen opvangbak
- Boorafscherming voorzien van een microscharakelaar, bij het openen valt de machine stil.
- Keuzeschakelaar links - rechtsdraaiend
- Op aanvraag leverbaar in 3x220V/50Hz en 3x440V/60Hz

Opmerking: 3x220V = krachtstroom (drijfkraft). Dit is niet hetzelfde als 1x230V mono = wisselstroom

Installatie, ingebruikname en scholing niet inbegrepen

Order nr.	713336028	
Orig. nr.	MF2 VARIO DPA	
Elektrische aansluiting		
Spanning	V	3x400
Vermogen verticale spindel	kW	1,5
Boorcapaciteit in staal S235JR	mm	24
Boorcapaciteit bij continu gebruik S235JR	mm	20
Freescapaciteit vingerfrees maximum	mm	18
Freescapaciteit vlakfrees maximum	mm	76
Spilopname	ISO	40 DIN2080
Freeskop draaibaar	°	90
Freeskop zwenkbaar	°	45
Boorvoeding	mm/omw	0,04/0,08/0,15
Spilverplaatsing	mm	127
Aantal verticale spiltoeren		6 vario
Verticale spindeltoeren	min-1	10-5.100
Uitlading verticaal	mm	213-533
Verplaatsingen		
Rijweg Y-assen manueel	mm	305
Rijweg Z-assen manueel	mm	406
Rijweg X-assen automatisch	mm	800
Horizontale tafel l x b	mm	1244x230
Maximum belastbaar gewicht	kg	230
T-gleuven grootte/afstand/aantal	mm	16 / 63
Afstand verticale spindel-kruistafel	mm	57-463
Gewicht	kg	950,00
Afmetingen (l x b x h)	mm	1520 x 1370 x 1900
Prijs	€	10.900,00

MF2 VARIO

ISO 40

ACCESSOIRES
p.1012-1091



- Digitale uitlezing op 3 assen

1,5KW VARIO 950kg

- Snelheidsomvormer **LENZE®**

- Freeskop is 90° draaibaar & 45° neigbaar

- Spindelrem
- 3 automatische boorvoedingen

- Draaiknop variabele spilsnelheden
- Aparte noodstop

- ISO 40 spildiameter 90mm
- Koeling
- Freesspilafscherming met microscharelaar

- Bedieningspaneel op pendelarm

- Overzichtelijke elektrische kast

- Manuele Z verplaatsing

- Automatische elektronische langvoeding X

- Spanenopvangbak

VERPL.

X: 800mm (auto)
Y: 305mm (man.)
Z: 406mm (man.)

Standaard geleverd met :

- Aantrekstang M16
- Digitale uitlezing op 3 assen
- Automatische voeding X as
- Bedieningsleutels
- Nederlandstalige handleiding, opschriften, CE - kenmerk, en CE-attest volgens Machine richtlijn 2006/42/CE, Laagspanningsrichtlijn 2006/95/CE en EMC Richtlijn 2004/108/CE



Stabiele torenfreesmachines met frequentiesturing LENZE "Made in EU" voor de professionele gebruiker en algemene industrie.

- Kwaliteitsfreesmachine met frequentiegestuurde spijlsnelheden (LENZE) met een heel groot bereik.
 - Spijsnelheden 9 - 6.750 tpm.
 - Door groot bereik inzetbaar op tal van ferro en non-ferro materialen
 - Hoge rondloop nauwkeurigheid door precisie kogellagers beter dan 0,01 mm
 - Zware, massieve uitvoering uit hoogwaardig Meehanite gietijzer
 - Alle assen (X, Y en Z) voorzien van precisie geslepen, stabiele blokgeleiding op de Y-as.
 - Centrale smering van de geleidingen
 - Stabiele kruistafel met geslepen T-gleuven en voorzien van een koelrand.
 - Boorvoeding op de spil met boordiepte aanslag, afleesbaar langs de voorzijde en met mm schaalverdeling
 - Spil is eveneens voorzien van een rem
 - Freeskop is links/rechts onder hoek verstelbaar en is ook naar voren en naar achteren kantelbaar.
 - Massieve freesram kan eveneens naar voren en naar achteren zich verplaatsen
 - Degelijke rubberen afscherming voor de zwaluwstaartgeleidingen
 - Digitale uitlezing DPA2000 op 3 assen gemonteerd met precisie **glasmeetlinialen**.
 - Elektronische automatische langsvvoeding op de X-as, bekabeling mooi weggewerkt in een beschermingskabel
 - Elektronische automatische dwarsvoeding op de Y-as, bekabeling mooi weggewerkt in een **beschermingskabel**
 - **Gemotoriseerde tafelverplaatsing**
 - **MF4DPA is eveneens voorzien van een pneumatische gereedschapsaanrekkker**
 - Ergonomisch, zwenkbaar en gebruiksvriendelijk bedieningspaneel op pendelarm
 - Hoofdschakelaar met motorbeveiliging, aparte start/stop knop, aparte noodstop, potentiometer voor de regeling van de snelheden, bedieningsknoppen voor de tafel.
 - Gesloten koelvloeistofsysteem met koelpomp
 - Degelijke spanen opvangbak
 - Boorafscherming voorzien van een microschakelaar, bij het openen valt de machine stil.
 - Keuzeschakelaar links - rechtsdraaiend
 - Op aanvraag leverbaar in 3x220V/50Hz en 3x440V/60Hz
- Opmerking: 3x220V = krachtstroom (drijfkraft). Dit is niet hetzelfde als 1x230V mono = wisselstroom Installatie, ingebruikname en scholing niet inbegrepen

Order nr.	713336048	
Orig. nr.	MF4 VARIO DPA	
Elektrische aansluiting		
Spanning	V	3x400
Vermogen verticale spindel	kW	3,75
Boorcapaciteit in staal S235JR	mm	32
Boorcapaciteit bij continu gebruik S235JR	mm	28
Freescapaciteit vingerfrees maximum	mm	20
Freescapaciteit vlakfrees maximum	mm	100
Spilopname	ISO	40 DIN2080
Freeskop draaibaar	°	90
Freeskop zwenkbaar	°	45
Boorvoeding	mm/omw	0,04/0,08/0,15
Spilverplaatsing	mm	127
Aantal verticale spilloeren		8 vario
Verticale spindeltoeren	min-1	9-6.750
Uitlading verticaal	mm	200-680
Verplaatsingen		
Rijweg Z-as manueel	mm	406
Rijweg X-as automatisch	mm	800
Rijweg Y-as automatisch	mm	400
Horizontale tafel l x b	mm	1370x254
Maximum belastbaar gewicht	kg	275
T-gleuven grootte/afstand/aantal	mm	16 / 63
Afstand verticale spindel-kruistafel	mm	40-446
Gewicht	kg	1150,00
Afmetingen (l x b x h)	mm	1500 x 1450 x 2200
Prijs	€	14.390,00

MF4 VARIO

ISO 40

ACCESSOIRES

p.1012-1091

3,75KW VARIO 1150kg

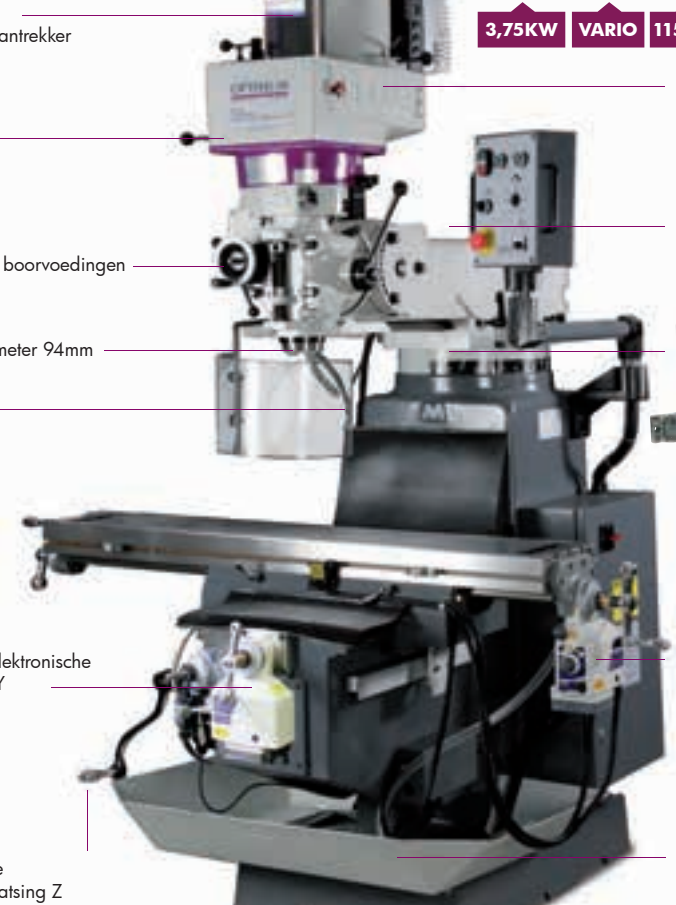
- 
- Pneumatische gereedschapsaan trekker
 - Spilrem
 - 3 automatische boorvoedingen
 - ISO 40 spildiameter 94mm
 - Koeling
 - Automatische elektronische dwarsvoeding Y
 - Gemotoriseerde verticale verplaatsing Z
 - Snelheidsomvormer LENZE ®
 - Draaiknop variabele spilsnelheden
 - Digitale uitlezing op 3 assen
 - Automatische elektronische langsvoeding X
 - Spanenopvangbak

VERPL.

X: 800mm (auto)
Y: 400mm (auto)
Z: 406mm (man.)

Standaard geleverd met :

- Aantrekstang M16
- Digitale uitlezing op 3 assen
- Automatische voeding X as
- Automatische voeding Y-as
- Gemotoriseerde tafilverplaatsing Zas
- Pneumatische gereedschapswisselaar
- Bedieningsleutels
- Nederlandstalige handleiding, opschriften, CE - kenmerk, en CE-attest volgens Machine richtlijn 2006/42/CE, Laagspanningsrichtlijn 2006/95/CE en EMC Richtlijn 2004/108/CE

Universele freesmachines



Universele freesmachine met horizontale en verticale spindel met digitale uitlezing gemonteerd op 3 assen.

- Zware, massieve uitvoering (900 kg) met tandwieloverbrenging.
- Krachtige motoren op de horizontale en verticale spindels. Respectievelijk van 1.500 Watt en 1.500 Watt.

- Verticale freesspil opname ISO40 DIN2080

- Horizontale freesspil opname ISO40 DIN2080

- Met 8 verticale snelheden 115 – 1750 tpm en met 9 horizontale snelheden 58 – 1355 tpm.
- Freeskop is langs beide zijden onder hoek instelbaar +/- 90°, maakt de meeste freesbewerkingen onder iedere hoek mogelijk.
- Bediening en digitale uitlezing verwerkt in één paneel op pendelarm, met aparte start/stop drukknop en aparte noodstop, met keuzeschakelaar links - rechtsdraaiend
- Stervormige handgreep met ijzeren handvatten.
- **Digitale uitlezing op 3 assen gemonteerd**
- **Mechanische automatische langs (X-as) voeding**
- Rijweg Y-as manueel 200 mm
- Vastzetten van alle rijwegen mogelijk en alle verplaatsingen zijn met een schaal aanduiding uitgerust - Handwiel voor fijne manuele voeding
- Stabiele en precieze zwaluwstaartuitvoering met regelbare spie-geleiders op de 3 assen
- Massieve en precies geslepen kruistafel met T-gleuven en koelmiddelrand. Langsverplaatsing voorzien van mechanisch instelbare eindeloop schakelaars.
- Boorafscherming voorzien van een microschatelaar, bij het openen valt de machine stil.

Order nr. 713336005

Orig. nr. MT50

Elektrische aansluiting

Spanning	V	3x400
Vermogen verticale spindel	kW	1,5
Boorcapaciteit in staal S235JR	mm	30
Boorcapaciteit bij continu gebruik S235JR	mm	25
Freescapaciteit vingerfrees maximum	mm	30
Freescapaciteit vlakfrees maximum	mm	100
Spilopname	ISO	40
Freeskop zwenkbaar	°	90
Spilverplaatsing	mm	120
Aantal verticale spiltoeren		8
Verticale spindeltoeren	min-1	115-1750
Uitlading verticaal	mm	240-650
Horizontale spilopname	ISO	40
Aantal horizontale spiltoeren		9
Horizontale spindeltoeren	min-1	58-1355
Uitlading horizontaal	mm	0 - 185

Verplaatsingen

Rijweg Y-as manueel	mm	200
Rijweg Z-as manueel	mm	340
Rijweg X-as automatisch	mm	380
Tafelvoeding X as	mm/min	24-720
Horizontale tafel l x b	mm	800x240
T-gleuven grootte/afstand/aantal	mm	4/14
Gewicht	kg	900,00
Afmetingen (l x b x h)	mm	2270 x 1500 x 2100

Prijs € **7.390,00**

MT50

ISO 40

ACCESSOIRES

p.1012-1091



VERPL.

X: 380mm (auto)
Y: 200mm (man.)
Z: 340mm (man.)

Standaard geleverd met :

- Aantrekstang
- Bedieningsleutels
- Nederlandstalige handleiding, opschriften, CE - kenmerk, en CE-attest volgens Machine richtlijn 2006/42/CE, Laagspanningsrichtlijn 2006/95/CE en EMC Richtlijn 2004/108/CE



Universele freesmachine met freeskop type Huron en digitale aflezing op 3 assen. Veelzijdig en eenvoudig om te bouwen voor het universele freeswerk in de werkplaats.

- Door de speciale freeskop type Huron over 2 draaiassen is deze machine veelzijdig inzetbaar
- Zware, massieve uitvoering uit hoogwaardig Meehanite gietijzer
- Opnameconus ISO40 DIN2080
- Alle zwaluwstaartgeleidingen zijn gehard en geslepen en voorzien van regelbare afstelspieën
- Centrale smering van de geleidingen
- Digitale uitlezing DPA2000 op 3 assen gemonteerd met precisie glasmeetlinialen
- Geïntegreerd Optimum bedieningspaneel, ergonomisch, zwenkbaar en gebruiksvriendelijk op pendelarm. Aparte start/stop knop, aparte noodstop.
- Mechanische automatische langs- en dwarsvoeding, 9 traps, 24 – 402 mm/min
- Gemotoriseerde tafolverplaatsing om de robuuste kruistafel gebruiksvriendelijk te verplaatsen
- Massieve kruistafel, precies geslepen bovenvlak, groot gedimensioneerd en voorzien van T-gleuven.
- Groot gedimensioneerde handwielen met mm schaalverdeling
- Ophanging voor een horizontale freespositie met freesas
- Eenvoudige bediening van de snelheden op de ram door twee schakelhendels
- Hoofdschakelaar met motorbeveiliging
- Gesloten koelvoelstofsysteem met koelpomp
- Optimum LED machineverlichting
- Degelijke spanen opvangbak
- Freesafscherming voorzien van een microscharakelaar, bij het openen valt de machine stil, en inclusief tafelafscherming
- Keuzeschakelaar links - rechtsdraaiend
- Op aanvraag leverbaar in 3x220V/50Hz en 3x440V/60Hz

Opmerking: 3x220V = krachtstroom (drijfkracht). Dit is niet hetzelfde als 1x230V mono = wisselstroom

Installatie, ingebruikname en scholing niet inbegrepen

Order nr.		713336110
Orig. nr.		MT100
Elektrische aansluiting		
Spanning	V	3x400
Gezamenlijk vermogen	kW	3.6
Vermogen verticale spindel	kW	2.2
Vermogen voedingsmotor	kW	0.370
Vermogen tafelmotor	W	750
Vermogen koelpomp	W	40
Boorcapaciteit in staal S235JR	mm	20
Boorcapaciteit bij continu gebruik S235JR	mm	18
Freescapaciteit vingerfrees maximum	mm	16
Freescapaciteit vlakfrees maximum	mm	85
Spilopname	ISO	40 DIN2080
Aantrekstang		M16
Freeskop draaibaar	°	360
Aantal verticale spiltoeren		11
Verticale spindeltoeren	min-1	40-1.600
Verplaatsingen		
Rijweg X-as manueel	mm	600
Rijweg Y-as manueel	mm	270
Rijweg X-as automatisch	mm	600
Rijweg Y-as automatisch	mm	270
Rijweg Z-as automatisch	mm	380
Aantal voedingen		9
Tafelvoeding X as	mm/min	24-402
Tafelvoeding Y-as	mm/min	24-402
Tafelvoeding ijlgang X as	mm/min	402
Tafelvoeding ijlgang Y as	mm/min	402
Tafelvoeding ijlgang Z as	mm/min	402
Horizontale tafel l x b	mm	1120x260
Maximum belastbaar gewicht	kg	350
T-gleuven grootte/afstand/aantal	mm	14/63/3
Afstand verticale spindel-kruistafel	mm	90-520
Gewicht	kg	1360,00
Afmetingen (l x b x h)	mm	2100 x 1520 x 2220
Prijs	€	11.320,00

MT100

ISO 40

NEW

ACCESSOIRES

p.1012-1091

3,6 KW

1360kg

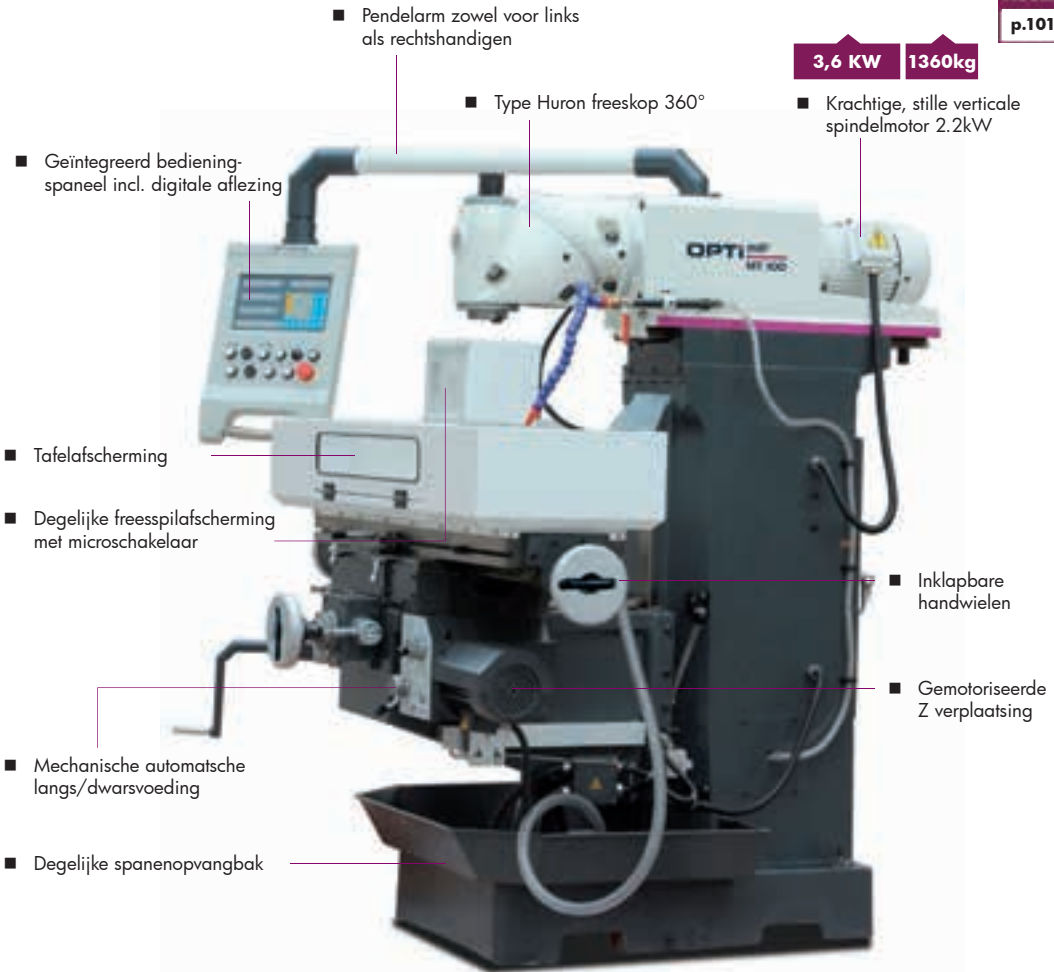

■ Pendelarm zowel voor links als rechtshandigen

■ Type Huron freeskop 360°

■ Krachtige, stille verticale spindel motor 2.2kW

■ Geïntegreerd bedieningspaneel incl. digitale aflezing

■ Tafelafscherming

■ Degelijke freesspilafscherming met microscharakelaar

■ Inklapbare handwielen

■ Gemotoriseerde Z verplaatsing

■ Mechanische automatische langs/dwarsvoeding

■ Degelijke spanenopvangbak

VERPL.

X: 600mm (auto)
Y: 270mm (auto)
Z: 380mm (gemotor.)

Standaard geleverd met :

- 360° verstelbare freeskop type Huron
- Aantrekstang M16
- Digitale uitlezing op 3 assen
- Mechanische automatische voeding X en Y as
- Gemotoriseerde taferverplaatsing Z-as
- Freesas ø 32 mm
- Spantangenhouder
- Vlakfreeshouder ISO40 / ø 32 mm
- Bedieningslevelts
- Nederlandstalige handleiding, opschriften, CE - kenmerk, en CE-attest volgens Machine richtlijn 2006/42/CE, Laagspanningsrichtlijn 2006/95/CE en EMC Richtlijn 2004/108/CE

Boor-freesmachines



Universele freesmachine met freeskop type Huron, 3 automatische mechanische voedingen en digitale aflezing op 3 assen.

- Door de speciale freeskop type Huron over 2 draaiassen is deze machine veelzijdig inzetbaar
- Zware, massieve uitvoering uit hoogwaardig Meehanite gietijzer
- Verticale opnameconus ISO50 DIN2080
- Horizontale opnameconus ISO50 DIN2080
- Alle zwaluwstaartgeleidingen zijn gehard en geslepen en voorzien van regelbare afstelspieën
- Centrale smering van de geleidingen
- Digitale uitlezing DPA2000 op 3 assen geïntegreerd in het bedieningsbord
- Pendelarm zowel links als rechts inzetbaar
- Mechanische automatische langs-, dwars- en verticale voeding
- Massieve kruistafel, precies geslepen bovenvlak, groot gedimensioneerd en voorzien van T-gleuven
- Groot gedimensioneerde handwielen met mm schaalverdeling
- Ophanging voor een horizontale freespositie met freesas
- Eenvoudige bediening van de snelheden op de ram door drie schakelhendels
- Links – rechtsloop
- Ergonomisch, zwenkbaar en gebruiksvriendelijk bedieningspaneel op pendelarm
- Aparte start/stop knop, aparte noodstop, bedieningsknoppen voor de tafel
- Hoofdschakelaar met motorbeveiliging
- Gesloten koelvloeistofsysteem met koelpomp
- Halogeen machinerlichting
- Degelijke spanen opvangbak
- Boorafscherming voorzien van een microscharakelaar, bij het openen valt de machine stil, en inclusief tafelaafscherming
- Keuzeschakelaar links - rechtsdraaiend
- Op aanvraag leverbaar in 3x220V/50Hz en 3x440V/60Hz

Opmerking: 3x220V = krachtstroom (driïfkracht). Dit is niet hetzelfde als 1x230V mono = wisselstroom

Installatie, ingebruikname en scholing niet inbegrepen.

Order nr.	713336120	
Orig. nr.	MT200	
Elektrische aansluiting		
Spanning	V	3x400
Gezamenlijk vermogen	kW	9,2
Vermogen verticale spindel	kW	4
Vermogen horizontale spindel	kW	4
Vermogen voedingsmotor	kW	1,1
Vermogen koelpomp	W	90
Tankinhoud	l	27
Boorcapaciteit in staal S235JR	mm	30
Boorcapaciteit bij continu gebruik S235JR	mm	28
Freescapaciteit vingerfrees maximum	mm	20
Freescapaciteit vlakfrees maximum	mm	100
Spilopname	ISO	50
Freeskop draaibaar	°	360
Freeskop zwenkbaar	°	360
Aantal verticale spiltoeren		12
Verticale spindeltoeren	min-1	60-1.750
Horizontale spilopname	ISO	50 DIN2080/M24
Aantal horizontale spiltoeren		12
Horizontale spindeltoeren	min-1	58-1.800
Verplaatsingen		
Rijweg X-as manueel	mm	1290
Rijweg Y-as manueel	mm	268
Rijweg X-as automatisch	mm	1.000
Rijweg Y-as automatisch	mm	280
Rijweg Z-as automatisch	mm	400
Aantal voedingen		9
Tafelvoeding X as	mm/min	22-420
Tafelvoeding Z-as	mm/min	10-168
Tafelvoeding Y-as	mm/min	22-393
Tafelvoeding ijlgang X as	mm/min	1.290
Tafelvoeding ijlgang Y as	mm/min	1205
Tafelvoeding ijlgang Z as	mm/min	513
Kruistafel verstelbaar	°	35
Maximum belastbaar gewicht	kg	450
T-gleuven grootte/afstand/aantal	mm	14/63/3
Gewicht	kg	1300,00
Afmetingen (l x b x h)	mm	2070 x 2260 x 2250
Prijs	€	18.990,00

MT200

ISO 50

ACCESSOIRES

p.1012-1091

9,2 KW

1300kg

- Verticale spijnsnelheden 60-1750 tpm
- 360°
- Ergonomisch bedieningsbord met digitale uitlezing op 3 assen
- Horizontale spijnsnelheden 58-1800 tpm
- Centrale smering van de kruistafel
- Draaibaar 35°
- Mechanische automatische voedingen X, Y en Z
- Degelijke spanenopvangbak
- Standaard koelpomp

VERPL.

X: 1290mm (auto)
Y: 280mm (auto)
Z: 400mm (auto)

Standaard geleverd met :

- 360° verstelbare freeskop type Huron
- Aantrekstang M24
- Digitale uitlezing op 3 assen
- Mechanische automatische voeding X, Y en Z as
- Bedieningsleutels
- Nederlandstalige handleiding, opschriften, CE - kenmerk, en CE-attest volgens Machine richtlijn 2006/42/CE, Laagspanningsrichtlijn 2006/95/CE en EMC Richtlijn 2004/108/CE

Boor-freesmachines



Multifunctionele torenfreesmachine met gereedschapsaan trekker voor professioneel gebruik met digitale positieaanduiding op 3 assen.

Overtuigende argumenten: Kwaliteit, efficiëntie en prijs.

- Zwaar, compact model uit hoogwaardige Meehaniet gietijzer
- Solide rechthoekige (blok) geleidingen op de Y en Z as
- Solide, precieze kruistafel, groot gedimensioneerd en precisie geslepen oppervlak
- Alle assen zijn instelbaar door middel van spieen
- Instelbare boordiepte via millimeter schaal, afleesbaar aan de voorzijde
- Hoge rondloop nauwkeurigheid door conische rollagers minder dan 0.01 mm gemeten in de spindel
- Digitale positie weergave geïntegreerd in bedieningsunit
- Automatische boorvoeding
- Rechts / linksdraaiend voor het draadsnijden
- Gesloten koelsysteem
- Automatische mechanische voeding op de X, Y en Z as
- Siemens elektrisch systeem
- 20 schakelbare spilsnelheden door twee snelheidmotor in verbinding met 5 snarengamma's.
- Verticale freeskop kan zowel links als rechts onder hoek geplaatst worden. Deze kan niet naar voor en achteren geplaatst worden om zo zijn stabiliteit te bewaren bij het frezen.
- Verticale opnameconus ISO40 DIN2080 met krachtige 5.5 kW motor.
- Horizontale opnameconus ISO50 DIN2080 met krachtige 4 kW motor
- Centrale smering van de geleidingen
- Digitale uitlezing DPA2000 op 3 assen geïntegreerd in het bedieningsbord.
- Pendelarm zowel links als rechts inzetbaar.
- Pneumatische gereedschapsaan trekker op de verticale spindel
- Hoofdschakelaar met motorbeveiliging
- Gesloten koelvloeistofsysteem met koelpomp
- Optimum LED machineverlichting
- Siemens elektrische componenten
- Degelijke spanen opvangbak
- Boorafscherming voorzien van een microscharakelaar, bij het openen valt de machine stil, en inclusief tafelaafscherming
- Op aanvraag leverbaar in 3x220V/50Hz en 3x440V/60Hz

Opmerking: 3x220V = krachtstroom (drijfkracht). Dit is niet hetzelfde als 1x230V mono = wisselstroom

Installatie, ingebruikname en scholing niet inbegrepen.

Order nr.	713336088 M	
Orig. nr.	MT8	
Elektrische aansluiting		
Spanning	V	3x400
Gezamenlijk vermogen	kW	10
Vermogen verticale spindel	kW	5.5
Vermogen horizontale spindel	kW	4
Luchtdrukaansluiting	bar	min. 6
Boorcapaciteit in staal S235JR	mm	30
Boorcapaciteit bij continu gebruik S235JR	mm	21
Freescapaciteit vingervrees maximum	mm	25
Freescapaciteit vlakfrees maximum	mm	80
Freeskop draaibaar	°	+/- 45
Boorvoeding	mm/omw	0.086/0.045/0.142
Spilverplaatsing	mm	140
Aantal verticale spiltoeren		20
Verticale spindeltoeren	min-1	60-4.660
Horizontale spilopname	ISO	50 DIN2080
Horizontale spindeltoeren	min-1	58-1.800
Verplaatsingen		
Rijweg X-as automatisch	mm	980
Rijweg Y-as automatisch	mm	300
Rijweg Z-as automatisch	mm	450
Aantal voedingen		9
Tafelvoeding X as	mm/min	15-370
Tafelvoeding Y-as	mm/min	15-370
Horizontale tafel l x b	mm	1320x360
Maximum belastbaar gewicht	kg	350
T-gleuven grootte/afstand/aantal	mm	18/80/3
Gewicht	kg	2500,00
Afmetingen (l x b x h)	mm	2950 x 2100 x 2550
Prijs	€	20.500,00



- Horizontale freespositie
- Voor horizontale freesbewerkingen met freesas
- Instelbare geleidingslagers
- Mechanische voedinge op X en Y as

MT8

ISO 40

ISO 50

NEW

ACCESSOIRES

p.1012-1091

- Krachtige verticale spilmotor 5.5 kW

- Pneumatische gereedschapsaan trekker

- Geïntegreerd bedieningspaneel incl. digitale aflezing op pendelarm zowel voor links als rechtshandigen

5,5 KW 2500kg

- Degelijke freesspil afscherming met microscharrelaar, alsook een tafel afscherming

- Gemotoriseerde Z verplaatsing

- Degelijke spanenopvangbak

- Automatische boorvoeding
- freeskop draaibaar +/-45°

- Verdraaibare RAM

- Horizontale spindel ISO50

- Gesloten koelvloestofstelsysteem

- Krachtige stille motor 4kW

- Mechanische automatische langs- en dwarsvoeding



X: 980mm (auto)
Y: 300mm (auto)
Z: 450mm (gemotor.)

Standaard geleverd met :

- Pneumatische gereedschapsaan trekker op de verticale spindel
- Digitale uitlezing op 3 assen
- Mechanische automatische voeding X en Y as
- Horizontale freesas
- Snelspan boorkop 1-16 mm / B18
- Kegeldoorn ISO40 / B18
- Freesdoorn 7:24 ISO50
- Bedieningsleutels
- Nederlandstalige handleiding, opschriften, CE - kenmerk, en CE-attest volgens Machine richtlijn 2006/42/CE, Laagspanningsrichtlijn 2006/95/CE en EMC Richtlijn 2004/108/CE



Kwaliteits en precisie gereedschapsfreesmachine voor de professionele gebruiker met digitale positieaanduiding op 3 assen.

- Veelzijdige toepassingsmogelijkheden
 - Met automatische voedingen in X, Y en Z assen als standaard
 - Precisie geslepen werktafels voor de horizontale en verticale positie met T-gleuven
 - Gebruiksvriendelijke snelheidsverandering
 - Robuuste machine constructie
 - Zware, solide, geribde hoogwaardig grijs gietijzeren basis
 - Alle geleidingen zijn gehard en instelbaar via spieën
 - Centrale smering
 - Groot gedimensioneerde handwielen met afleeschalen
 - Uitgerust met een gesloten koelsysteem
 - Geharde geleidingen
 - Spanen opvangbak
 - Spilkop onder hoek verstelbaar +/-90°
 - Grote spilverplaatsing 80 mm
 - 12 snelheden bij de MX2 en 18 snelheden bij de MX3 en MX4
 - Horizontale freespositie met ondersteuningsarm en freesas.
 - Verticale freeskop is wegklapbaar
 - Verticale opnameconus ISO40 DIN2080 met krachtige 2.2 kW motor bij de MX2 en MX3, met een krachtige motor 3 KW bij de MX4
 - Digitale uitlezing DPA2000 op 3 assen geïntegreerd in het bedieningsbord.
 - Pendelarm zowel links als rechts inzetbaar.
 - Hoofdschakelaar met motorbeveiliging
 - Machineverlichting
 - Booraafscherming voorzien van een microscharrelaar, bij het openen valt de machine stil, en inclusief tafelaafscherming open klapbaar.
- Op aanvraag leverbaar in 3x220V/50Hz en 3x440V/60Hz Opmerking: 3x220V = krachtstroom (drijfkracht). Dit is niet hetzelfde als 1x230V mono = wisselstroom

Order nr.	713346120	713346130	713346140
Orig. nr.	MX2	MX3	MX4
Elektrische aansluiting			
Spanning	V	3x400	3x400
Vermogen verticale spindel	kW	2,2	2,2
Boorcapaciteit in staal S235JR	mm	32	32
Boorcapaciteit bij continu gebruik S235JR	mm	28	28
Spilopname	ISO	40 (DIN 2080)	40 (DIN 2080)
Spilverplaatsing	mm	80	80
Aantal verticale spiltoren		12	18
Verticale spindeltoeren	min-1	40-1.600	40-2000
Uitlading verticaal	mm	680	425
Verplaatsingen			
Rijweg X-as automatisch	mm	405	400
Rijweg Y-as automatisch	mm	200	300
Rijweg Z-as automatisch	mm	390	390
Aantal voedingen		18	18
Tafelvoeding X as	mm/min	10-380	10-380
Tafelvoeding Z-as	mm/min	10-380	10-380
Tafelvoeding Y-as	mm/min	10-380	10-380
Tafelvoeding ijlgang X as	mm/min	1.200	1.200
Tafelvoeding ijlgang Y as	mm/min	1.200	1.200
Horizontale tafel l x b	mm	750 x 320	750 x 320
Afstand horizontale spindel - kruistafel	mm	35 - 425	85 - 485
Verticale tafel l x b	mm	830 x 225	830 x 225
Afstand verticale spindel-kruistafel	mm	60 - 440	50 - 450
T-gleuven grootte/afstand/aantal	mm		
Maximum lengte (DPA arm links/rechts)	mm	1.880 / 1.340	1.880 / 1.340
Gewicht	kg	950,00	1150,00
Afmetingen (l x b x h)	mm	1340 x 2200 x 1950	1340 x 2200 x 1950
Prijs	€	20.490,00	22.650,00
			26.700,00

MX2 - MX3 - MX4

ISO 40

NEW

ACCESSOIRES

p.1012-1091

3 KW

1250kg

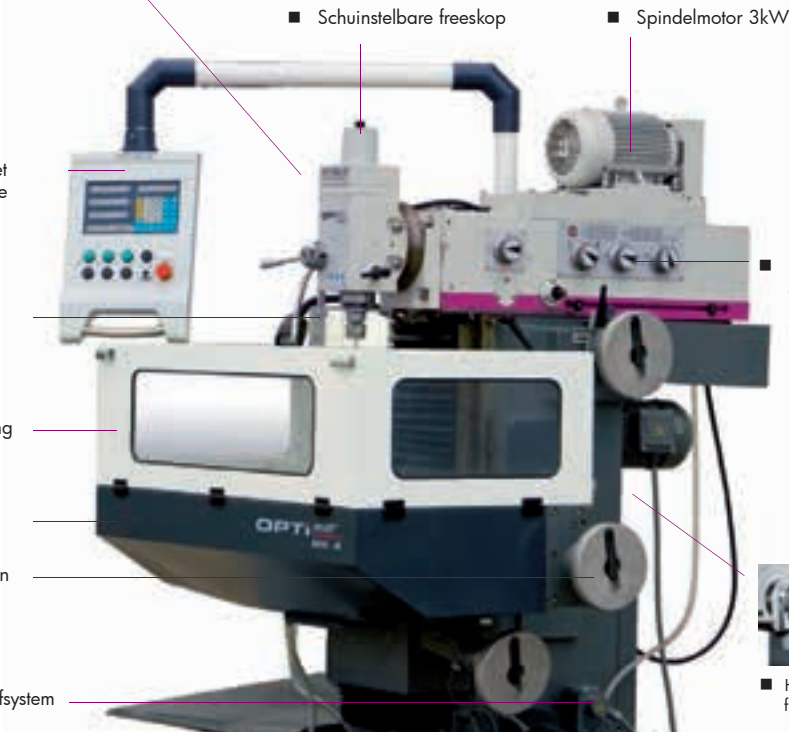
- 
- Bedieningspaneel met geïntegreerde digitale uitlezings op 3 assen
 - Spilkop onder hoek verstelbaar +/-90°
 - Kruistafel en behuizing
 - Centrale smering
 - Veiligheidshandwielen
 - Gesloten koelvloeistofsystem met koelpomp
 - Schuinstelbare freeskop
 - Spindelmotor 3kW
 - 18 snelheden 40-2000 tpm
 - Horizontaal frezen positie

MX4

VERPL.

X: 980mm (auto)

Y: 300mm (auto)

Z: 450mm (gemotor.)

Standaard geleverd met :

- Bedieningsgereedschap
- Ondersteuningsarm voor horizontale freespositie
- Koeluitrusting
- Machineverlichting
- Digitale positieaanduiding op 3 assen
- Nederlandstalige handleiding, opschriften, CE - kenmerk, en CE-attest volgens Machine richtlijn 2006/42/CE, Laagspanningsrichtlijn 2006/95/CE en EMC Richtlijn 2004/108/CE Installatie, ingebruikname en scholing niet inbegrepen

KIES UW DRAAIBANK

	Vermogen	Centerhoogte	Centerlengte	Draaidiameter
TU 1503V	0,45	70	250	140
TU 2004V	0,6	100	300	200
TU 2304	0,75	115	450	230
TU 2304V	0,75	115	450	230
TU 2404	0,75	120	450	250
TU 2404V	1,1	120	450	250
TU 2506V	1,1	125	550	250
TU 2807	0,85	140	700	266
TU 2807V	1,5	140	700	266
D 320 x 630	1,5	160	630	320
D 320 x 920	1,5	160	920	320
TU 3209V	1,5	160	920	320
D 330 x 1000	1,5	165	1000	330
D 360 x 1000	1,5/2,4	180	1000	356
TU 3610V	4	180	1000	356
D 420 x1000/1500	4,5	210	1000/1500	420
TU 4210V	5,5	210	1000	420
D 460 x1000/1500/2000	5,5	230	1000/1500/2000	265
TU 4615V	7,5	230	1500	465
D 560 x 1500/2000/3000	7,5	280	1500/2000/3000	560
TU 5620V	7,5	280	2000	560
D 660 x 2000/3000	9	330	2000/3000	660
TU 8020/ TU 8030	11	330	2000/3000	660
TZ 4012	4	200	1150	400
TZ 5216	5,5	260	1625	530
TZ 6222	5,5	310	2225	620

Spilsnelheden	Klauwplaat 3 bekken	Klauwplaat 4 bekken	Vario Drive	Digit. snelheidsweergave	DPA Versie	Verlichting	230V	400V
120-3000	●		●				●	
150-2500	●		●	●			●	
125-2000	●						●	
150-2200	●		●	●			●	●
125-2000	●						●	
150-2500	●		●	●			●	
150-2500	●		●	●			●	
150-2000	●						●	●
30-4000	●		●	●			●	
65-1800	●	●				●	●	●
65-1800	●	●				●	●	●
12-2500	●	●	●	●		●	●	
70-2000	●	●				●		●
45-1800	●	●			●/-	●		●
30-3000	●	●	●	●	●	●		●
45-1800	●	●			●	●		●
30-3000	●	●	●	●	●	●		●
25-2000	●	●			●	●		●
30-2000	●	●	●	●	●	●		●
25-1600	●	●			●	●		●
25-1600	●	●	●	●	●	●		●
25-1600	●	●			●	●		●
25-1600	●				●	●		●
40-2200						●		●
30-1500						●		●
30-1500						●		●

Draaibanken



De nieuwe, compacte draaibank met elektronisch regelbare snelheden.

Argumenten, die in kwaliteit, prestatie en prijs overtuigen:

- Gelijkstroommotor met permanente toerentalbewaking 230V
- Geribd prismabed uit grijsgietijzer, inductie gehard en precisie geslepen
- Geharde en geslepen prismabedgeleidingen
- Gegarandeerde spilneus rondloop nauwkeurigheid beter dan 0,015 mm.
- Rondloopnauwkeurigheid klauwplaat max. 0.05 mm
- Met leispil voor het draadsnijden of automatisch langs draaien
- Met langs, dwars, en kleine slede
- Automatische langs / leispindelaandrijving
- Rechts / linkslopend omschakelbaar op het bedienpaneel
- Handwielen met instelbare fijn regeling 0,04/0,01 mm
- Twee-weg beitelhouder
- Alle geleidingen zijn door middel van spieën spelingsvrij af te stellen.
- Omvangrijke toebehoren
- Aparte noodstop, aparte start en stopknop
- **Elektronische traploze toerentalregeling vanaf 120 tot 3000 min-1.**
- Met wisselwielenset voor draadsnijden.

Order nr.		713420260
Orig. nr.		TU1503V
Capaciteit		
Centerhoogte	mm	70
Centerafstand	mm	250
Draaidiameter boven bed	mm	140
Bedbreedte	mm	70
Kop		
Aantal snelheden		variabel
Spindeltoerental	min-1	120-3.000
Spilkonus	MK	1
Spilboring	mm	11
Draadstappen en voeding		
Langsvoeding	mm/O	0,05-0,1
Draadsnijden metrisch	M	0.5-1.5 (11)
Geleiding en wagen		
Rijweg beitelsslede	mm	40
Rijweg dwarslede	mm	55
Hoogte beitelhouder	mm	12
Losse kop		
Konus losse kop	MK	1
Koers losse kop	mm	30
Elektrische aansluiting		
Spanning	V	1x230
Vermogen motor	kW	0,45
Gewicht	kg	22,00
Afmetingen (l x b x h)	mm	560 x 320 x 250
Prijs	€	749,00

TU1503V

NEW VARIO

250 mm

11 mm

70 mm

ACCESSOIRES

p.1012-1091

■ Variabele toerentalregeling

■ Aparte noodstop, start en stopknop

■ Links/rechtslopend

■ Standaard klauwplaat

■ Tegenpunt MK1 spil

■ Schakelhendel manueel of automatische langvoeding

■ Geribd prismabed

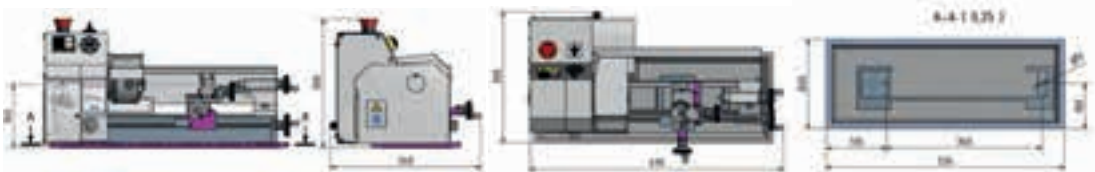

Standaard geleverd met :

- Klauwplaat met 3 klauwen 80 mm
- Vast centerpunt MK1
- Klauwplaatafscherming, spatwand en spanenbak
- 2-voudige beitelhouder
- Wisselwielenset.
- Nederlandstalige handleiding, opschriften, CE - kenmerk, en CE-attest



Draaibank met digitale toerentalweergave en variabele toerentalregeling.

Argumenten, die in kwaliteit, prestatie en prijs overtuigen:

- Hoge en precieze afwerkinggraad
- Sterk geribd prismabed uit grijsgietijzer, inductie gehard en precisie geslepen
- Geharde en geslepen prismabed geleidingen
- Geharde spilneus (DIN6350) en gelagerd in na stelbare kegelkogellagers klasse P5 kwaliteit.
- Gegarandeerde rondloop nauwkeurigheid van de spilneus beter dan 0,009 mm
- Met leispil voor het draad snijden of automatisch langs draaien
- Met langs, dwars, en kleine slede
- Rechts / linkslopend omschakelbaar op het bedienpaneel
- Nullast spanning.
- Klauwplaat afscherming met microscharrelaar, degelijke beetel afscherming en mooie spatwand
- Voorzien van druklagers
- Leispindel in twee sinterlagers
- Door een wisselwielen set een groot bereik bij het draad snijden.
- Tandwieloverbrenging
- **2 traps variabele toerentalregeling van 150 -250 min en 300- 2500 min. Eenvoudig instelbaar via een potentiometer.**
- **Digitale weergave van de spilsnelheden**
- Aparte noodstop en aparte start/stopknop. Nullast spanning.
- Voor vlakdraaien, langs draaien, en draad snijden.
- Losse kop kan +- 2,5 mm verschoven worden voor het draaien van kegels, met snelklemming van de losse kop voor een nog betere klemming
- Alle geleidingen door middel van spelijsen zonder speling na stelbaar.
- Krachtige, onderhoudsvrije motor.

Order nr.		713420310 M
Orig. nr.		TU2004V 230V
Capaciteit		
Centerhoogte	mm	100
Centerafstand	mm	300
Draaidiameter boven bed	mm	110
Bedbreedte	mm	100
Kop		
Aantal snelheden		2 traploos
Spindeltoerental	min-1	150-2.500
Spilkonus	MK	3
Spilboring	mm	21
Doorlaat klauwplaat	mm	20
Draadstappen en voeding		
Langsvoeding	mm/O	0.1-0.2
Draadsnijden metrisch	M	0,5-3 (11)
Draadsnijden duim	Gg/1"	44-10 (8)
Geleiding en wagen		
Rijweg beetelslede	mm	55
Rijweg dwarslede	mm	75
Hoogte beetelhouder	mm	12
Losse kop		
Konus losse kop	MK	2
Koers losse kop	mm	65
Elektrische aansluiting		
Spanning	V	1x230
Vermogen motor	kW	0,6
Gewicht	kg	61,00
Afmetingen (l x b x h)	mm	830 x 425 x 360
Prijs	€	1.159,00

TU2004V

NEW

300 mm

21 mm

100 mm

ACCESSOIRES
p.1012-1091

- Digitale weergave spijnsnelheden

- Aparte noodstop
- Klawwplaatafscherming met microscharakelaar

- Tegenpunt MK2 spil

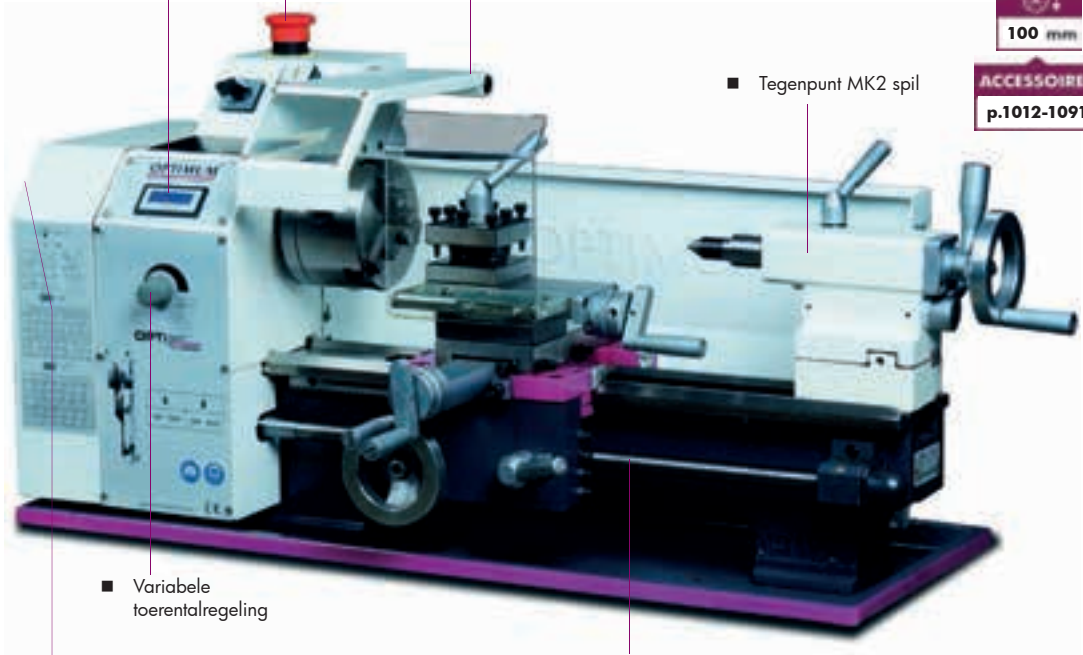

- Variabele toerentalregeling

- Rolgewalste leispindel

- Optionele voet



- Geharde & geslepen tandwielen



Order nr.	713440409
Orig. nr.	DMV
Gewicht	kg 45,00
Prijs	€ 359,00

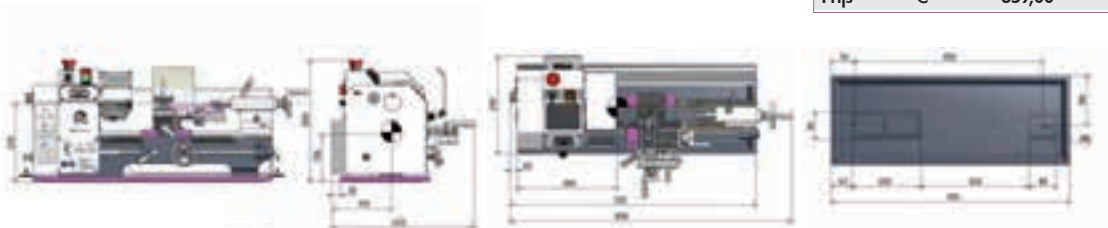

Standaard geleverd met :

- Klawwplaat met 3 klauwen 100 mm
- Vast centerpunt MK2
- Vast centerpunt MK3
- Klawwplaat- en beitel afscherming, spatwand en spanenbak
- 4-voudige beitelhouder

- Wisselwielen set.
- Bedieningsleutels
- Nederlandstalige handleiding, opschriften, CE kenmerk, en CE-attest volgens Machine richtlijn 2006/42/CE, Laagspanningsrichtlijn 2006/95/CE en EMC Richtlijn 2004/108/CE



Draaibank voor de veeleisende doe-het-zelver. TU2304V met digitale toerentalweergave en variabele toerentalregeling.

Argumenten, die in kwaliteit, prestatie en prijs overtuigen:

- Hoge en precieze afwerkinggraad
- Sterk geribd prismabed uit grijsgietijzer, inductie gehard en precisie geslepen
- Geharde en geslepen prismabed geleidingen
- Geharde spilneus en gelagerd in na stelbare kegelkogellagers klasse P5 kwaliteit.
- Gegarandeerde rondloop nauwkeurigheid van de spilneus beter dan 0,009 mm + rondloop nauwkeurigheid klauwplaat beter dan 0.05 mm
- Met leispil voor het draad snijden of automatisch langs draaien
- Met langs, dwars, en kleine slede
- Rechts / linkslopend omschakelbaar op het bedienpaneel
- Aparte noodstop, aparte start en stopknop. Nullast spanning.
- Klauwplaat afscherming met microscharakelaar, degelijke beitel afscherming en mooie spatwand
- Voorzien van druklager op de dwars (voor het opnemen van axiale krachten)
- Leispindel in twee sinterlagers (glijlagers met olie, die geen smering meer vereisen)
- Door een wisselwielen set een groot bereik bij het draad snijden.
- Tandwieloverbrenging

- 6 snelheden 125 - 2000 min-1 en bij TU2304V. 2 - traps variabele toerentalregeling van 150 -2.200 min-1. Eenvoudig instelbaar via een potentiometer.

- Digitale weergave van de spilsnelheden bij de TU2304V

- Voor vlakdraaien, langs draaien, en draad snijden.
- Losse kop kan +- 5 mm verplaatst worden voor het draaien van kegels, met snelklemming van de losse kop voor een nog betere klemming
- Alle geleidingen door middel van spelijsen zonder speling na stelbaar.
- Krachtige, onderhoudsvrije motor.

Order nr.		713420320 ^M	713420325 ^M
Orig. nr.		TU2304 230V	TU2304V 230V
Capaciteit			
Centerhoogte	mm	115	115
Centerafstand	mm	450	450
Draaidiameter boven bed	mm	230	230
Bedbreedte	mm	135	135
Kop			
Aantal snelheden		6	2 traploos
Spindeltoerental	min-1	125-2.000	150-2200
Spilkonus	MK	3	3
Spilboring	mm	21	21
Draadstappen en voeding			
Draadsnijden metrisch	M	0.4-3.5	0.4-3.5
Draadsnijden duim	Gg/1"	44-10	44-10
Geleiding en wagen			
Rijweg beitel slede	mm	75	75
Rijweg dwars slede	mm	120	120
Hoogte beitelhouder	mm	14x14	14x14
Losse kop			
Konus losse kop	MK	2	2
Koers losse kop	mm	70	70
Elektrische aansluiting			
Spanning	V	1x230	1x230
Vermogen motor	kW	0,75	0,75
Gewicht	kg	104,00	104,00
Afmetingen (l x b x h)	mm	965 x 585 x 510	965 x 585 x 510
Prijs	€	1.269,00	1.499,00

TU2304/TU2304V

- Geharde & geslepen tandwielen
- Aparte noodstop, start en stopknop
- Handwielen instelbaar 0,04/0,01mm

NEW

450 mm

ø21 mm

115 mm

ACCESSOIRES

p.1012-1091

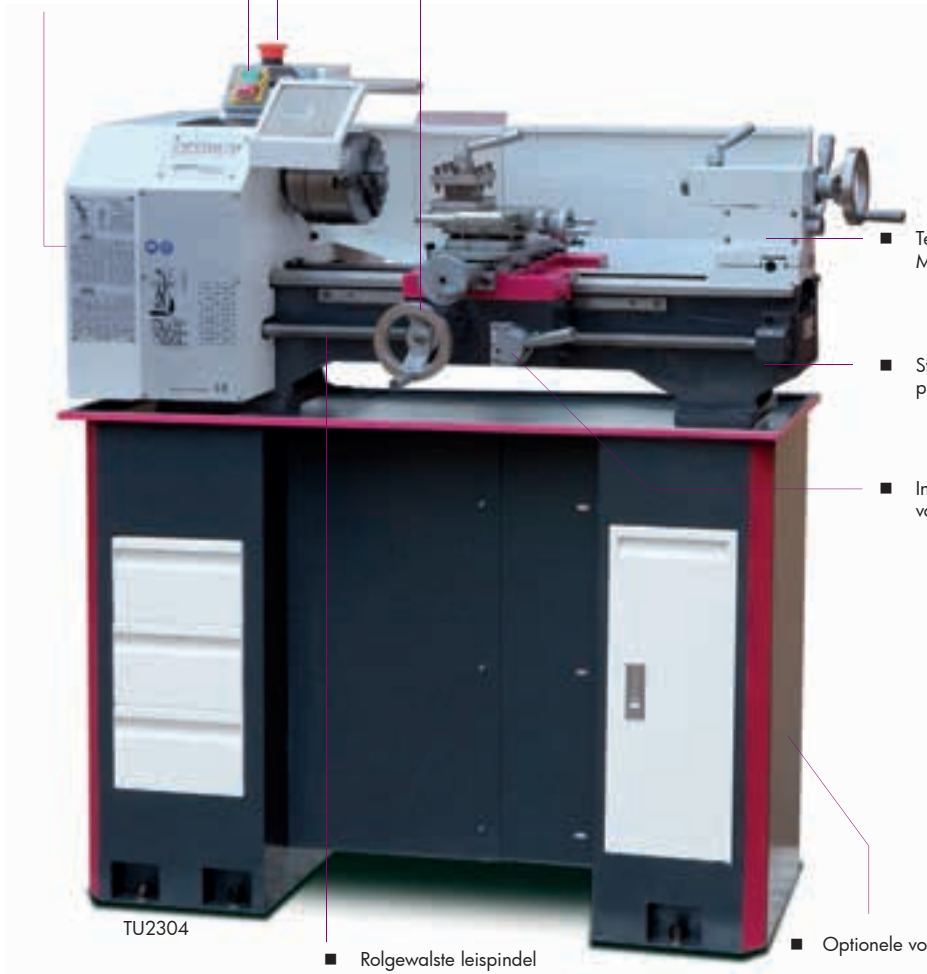

- Tegenpunt MK2 spil
- Sterk geribd prismabed
- Inschakelen voeding

TU2304

- Rolgewalste leispindel
- Optionele voet

Order nr.	713440409	
Orig. nr.	DMV	
Gewicht	kg	45,00
Prijs	€	359,00

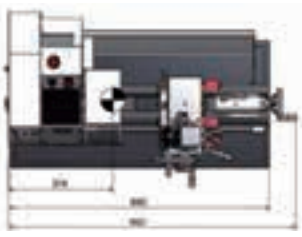

Standaard geleverd met :

- Klauwplaat met 3 klauwen 100 mm
- Vast centerpunt MK2
- Vast centerpunt MK3
- Klauwplaat- en beitel afscherming en spatwand
- 4-voudige beitelhouder
- Wisselwielen set.

- Bedieningsleutels
- Optioneel onderstel verkrijgbaar 713440409
- Nederlandstalige handleiding, opschriften, CE kenmerk, en CE-attest volgens Machine richtlijn 2006/42/CE, Laagspanningsrichtlijn 2006/95/CE en EMC Richtlijn 2004/108/CE

MACHINES



Draaibanken voor de veeleisende doe-het-zelver. TU2404V met variabele toerentalregeling.

Argumenten, die in kwaliteit, prestatie en prijs overtuigen:

- Hoge en precieze afwerkinggraad
 - Sterk geribd prismabed uit grijsgietijzer, inductie gehard en precisie geslepen
 - Geharde en geslepen prismabed geleidingen
 - Gegarandeerde rondloop nauwkeurigheid van de spilneus beter dan 0,009 mm
 - Rondloopnauwkeurigheid van de klauwplaat beter dan 0,05 mm
 - Met leispil voor het draad snijden of automatisch langs draaien
 - Met langs, dwars, en kleine slede
 - Rechts / linkslopend omschakelbaar op het bedienpaneel
 - Rolgewalste trapeziumspindel
 - Aparte noodstop, aparte start en stopknop. Nullast spanning.
 - Klauwplaat afscherming met microscharrelaar, degelijke beitel afscherming en mooie spatwand
 - Voorzien van druklagers
 - Leispindel in twee sinterlagers
 - Door een wisselwielen set een groot bereik bij het draad snijden.
 - Tandwieloverbrenging
 - TU2404V 2 traps variabele toerentalregeling van 150 -250 min en 300- 2500 min. Eenvoudig instelbaar via een potentiometer.
- Digitale snelheidsweergave.
- Voor vlakdraaien, langs draaien, en draad snijden.
 - Losse kop kan +- 5 mm verplaatst worden voor het draaien van kegels, met snelklemming van de losse kop voor een nog betere klemming
 - Alle geleidingen door middel van spelijsen zonder speling na stelbaar.
 - Krachtige, onderhoudsvrije motor.

Order nr.	713420330	713420333	713420335
Orig. nr.	TU2404 230V	TU2404 400V	TU2404V 230V
Capaciteit			
Centerhoogte	mm	125	125
Centerstand	mm	450	450
Draaidiameter boven bed	mm	250	250
Bedbreedte	mm	135	135
Kop			
Aantal snelheden		6	6
Spindeltoerental	min-1	125-2000	125-2000
Spilkonus	MK	3	3
Spilboring	mm	21	21
Draadstappen en voeding			
Langsvoeding	mm/O	0,1-0,2	0,1-0,2
Draadsnijden metrisch	M	0,4-3,5	0,4-3,5
Draadsnijden duim	Gg/1"	44-10	44-10
Geleiding en wagen			
Rijweg beitel slede	mm	75	75
Rijweg dwars slede	mm	120	120
Hoogte beitelhouder	mm	14	14
Losse kop			
Konus losse kop	MK	2	2
Koers losse kop	mm	70	70
Elektrische aansluiting			
Spanning	V	1x230	3x400
Vermogen motor	kW	0,75	0,75
Gewicht	kg	110,00	110,00
Afmetingen (l x b x h)	mm	1020 x 520 x 560	1020 x 520 x 560
Prijs	€	1.449,00	1.449,00

TU2404 /TU2404V

NEW

450 mm

21 mm

125 mm

ACCESSOIRES

p.1012-1091

- Geharde & geslepen tandwielen
- Aparte noodstop, start en stopknop
- Fijnafstelling 0,04/0,01mm

- Precisie geslepen prismabed

- Rolgewalste leispindel

- Tegenpunt MK2 spil

- Inschakelen voeding

- Optionele voet

Order nr.	71344049	
Orig. nr.	DMV	
Gewicht	kg	45,00
Prijs	€	359,00

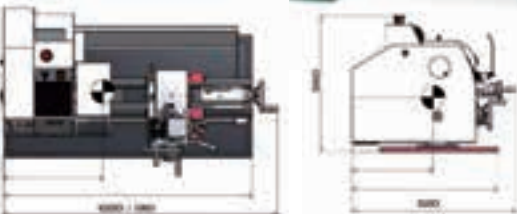
**Standaard geleverd met :**

- Klauwplaat met 3 klauwen 125 mm
- Vast centerpunt MK2
- Vast centerpunt MK3
- Klauwplaat- en beitel afscherming, spatwand en spanenbak
- 4-voudige beitelhouder

- Wisselwielen set.
- Bedieningsleutels
- Sokkel niet inbegrepen 713440409
- Nederlandstalige handleiding, opschriften, CE kenmerk, en CE-attest volgens Machine richtlijn 2006/42/CE, Laagspanningsrichtlijn 2006/95/CE en EMC Richtlijn 2004/108/CE



Draaibanken voor de veeleisende doe-het-zelver met variabele toerentalregeling.

Argumenten, die in kwaliteit, prestatie en prijs overtuigen:

- Hoge en precieze afwerkinggraad
- Sterk geribd prismabed uit grijsgietijzer, inductie gehard en precisie geslepen
- Geharde en geslepen prismabed geleidingen
- Gegarandeerde rondloop nauwkeurigheid van de spilneus beter dan 0,009 mm
- Rondlooptrouwkeurigheid van de klauwplaat beter dan 0,05 mm
- Met leispil voor het draad snijden of automatisch langs draaien
- Met langs, dwars, en kleine slede
- Rechts / linkslopend omschakelbaar op het bedienpaneel
- Rolgewalste trapeziumspindel
- Aparte noodstop, aparte start en stopknop. Nullast spanning.
- Klauwplaat afscherming met microscharakelaar, degelijke beitel afscherming en mooie spatwand
- Voorzien van druklager op de dwars (voor het opnemen van axiale krachten)
- Leispindel in twee sinterlagers (glijlagers met olie, die geen smering meer vereisen)
- Door een wisselwielen set een groot bereik bij het draad snijden.
- Tandwieloverbrenging

- 2-traps variabele toerentalregeling van 150 - 2.500 min. Eenvoudig instelbaar via een potentiometer. Digitale snelheidsweergave.

- Voor vlakdraaien, langs draaien, en draad snijden.
- Losse kop kan +- 5 mm verplaatst worden voor het draaien van kegels, met snelklemming van de losse kop voor een nog betere klemming
- Alle geleidingen door middel van speliijsten zonder speling na stelbaar.
- Krachtige, onderhoudsvrije motor.

Order nr.		713420355
Orig. nr.		TU2406V 230V
Capaciteit		
Centerhoogte	mm	125
Centerafstand	mm	550
Draaidiameter boven bed	mm	250
Bedbreedte	mm	135
Kop		
Aantal snelheden		2 traploos
Spindeltoerental	min-1	150-2500
Spilkonus	MK	3
Spilboring	mm	21
Draadstappen en voeding		
Draadsnijden metrisch	M	0.4-3.5
Draadsnijden duim	Gg/1"	44-10
Geleiding en wagen		
Rijweg beitel slede	mm	75
Rijweg dwars slede	mm	120
Hoogte beitelhouder	mm	14x14
Losse kop		
Konus losse kop	MK	2
Koers losse kop	mm	70
Elektrische aansluiting		
Spanning	V	1x230
Vermogen motor	kW	1.1
Gewicht	kg	125,00
Afmetingen (l x b x h)	mm	1310 x 520 x 560
Prijs	€	1.749,00

TU2406V

NEW

550 mm

21 mm

125 mm

ACCESSOIRES

p.1012-1091

■ Aparte noodstop, start en stopknop

■ Fijnafstelling 0,04/0,01mm

■ Precisie geslepen & gehard

■ Tegenpunt MK2 spil

■ Sterk geribd prismabed

■ Inschakelen voeding

TU2404

■ Optionele voet

Order nr.	713440409	
Orig. nr.	DMV	
Gewicht	kg	45,00
Prijs	€	359,00

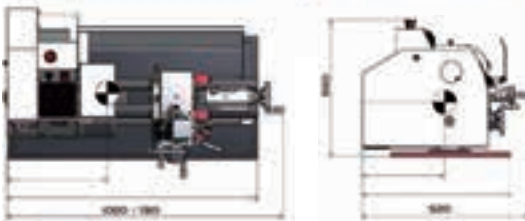

Standaard geleverd met :

- Klauwplaat met 3 klauwen 125 mm
- Vast centerpunt MK2
- Vast centerpunt MK3
- Klauwplaat- en beitel afscherming en spatwand
- 4-voudige beitelhouder
- Wisselwielen set.

- Bedienings sleutels
- Sokkel niet inbegrepen 713440409
- Nederlandstalige handleiding, opschriften, CE kenmerk, en CE-attest volgens Machine richtlijn 2006/42/CE, Laagspanningsrichtlijn 2006/95/CE en EMC Richtlijn 2004/108/CE.



Hoge precieze draaibank voor de veeleisende gebruiker. Vario uitvoering met borstelloze motor voor traploos regelbare toerentalregeling.

Argumenten, die in kwaliteit, prestatie en prijs overtuigen:

- Hoge en precieze afwerkinggraad
- Krachtige en onderhoudsvrije motor
- Sterk geribd prismabed uit grijsgietijzer, inductie gehard en precisie geslepen
- Geharde en geslepen prismabed geleidingen
- Gegarandeerde rondloop nauwkeurigheid van de spilneus beter dan 0,009 mm
- Rondloopnauwkeurigheid van de klauwplaat beter dan 0,04 mm
- Handwielen aan de wagen zijn fijn instelbaar 0,04 / 0,01 mm
- Met leispil voor het draad snijden of automatisch langs draaien
- Met langs, dwars, en kleine slede
- Rechts / linkslopend omschakelbaar op het bedienpaneel
- Aparte noodstop, aparte start en stopknop. Nullast spanning.
- Klauwplaat afscherming met microscharrelaar, degelijke beitel afscherming en mooie spatwand
- Voorzien van druklagers
- Leispindel in twee sinterlagers
- Door een wisselwielen set een groot bereik bij het draad snijden.
- Tandwieloverbrenging
- Losse kop kan +/- 5 mm verplaatst worden voor het draaien van kegels, met snelklemming van de losse kop voor een nog betere klemming
- Alle geleidingen door middel van spelijsen zonder speling na stelbaar.
- Voor vlakdraaien, langs draaien, en draad snijden.

TU2506V:

- Krachtige gelijkstroommotor met rustige loop met een uitzonderlijke afregelkarakteristiek
- 4 traps variabele toerentalregeling van 30- 4.000 min-1. Eenvoudig instelbaar via een potentiometer.
- Digitale snelheidsweergave.
- Uitgerust met een hoge precisie stalen klauwplaat voor hogere toerentallen.

Order nr.	713425001	713425003	713425006
Orig. nr.	TU2506 230V	D240X500G 400V	TU2506V
Capaciteit			
Centerhoogte	mm 125	125	125
Centerafstand	mm 550	550	550
Draaidiameter boven bed	mm 250	250	250
Bedbreedte	mm 135	135	135
Kop			
Aantal snelheden	6	6	4 traploos
Spindeltoerental	min-1 125-2000	120-2000	30-4000
Spilkonus	MK 4	4	4
Spilboring	mm 26	26	26
Draadstappen en voeding			
Langsvoeding	mm/O 0.070.2	0.070.2	0.070.2
Draadsnijden metrisch	M 0.2-3.5	0.2-3.5	0.2-3.5
Draadsnijden duim	Gg/1" 56-8	56-8	56-8
Geleiding en wagen			
Rijweg beitelslede	mm 70	70	70
Rijweg dwarslede	mm 110	110	110
Hoogte beitelhouder	mm 13	13	13
Losse kop			
Konus losse kop	MK 2	2	2
Koers losse kop	mm 65	65	65
Elektrische aansluiting			
Spanning	V 1x230	3x400	1x230
Vermogen motor	kW 0,75	0.750	1.5
Prijs	€ 1.590,00	1.590,00	2.390,00

TU2506/TU2506V

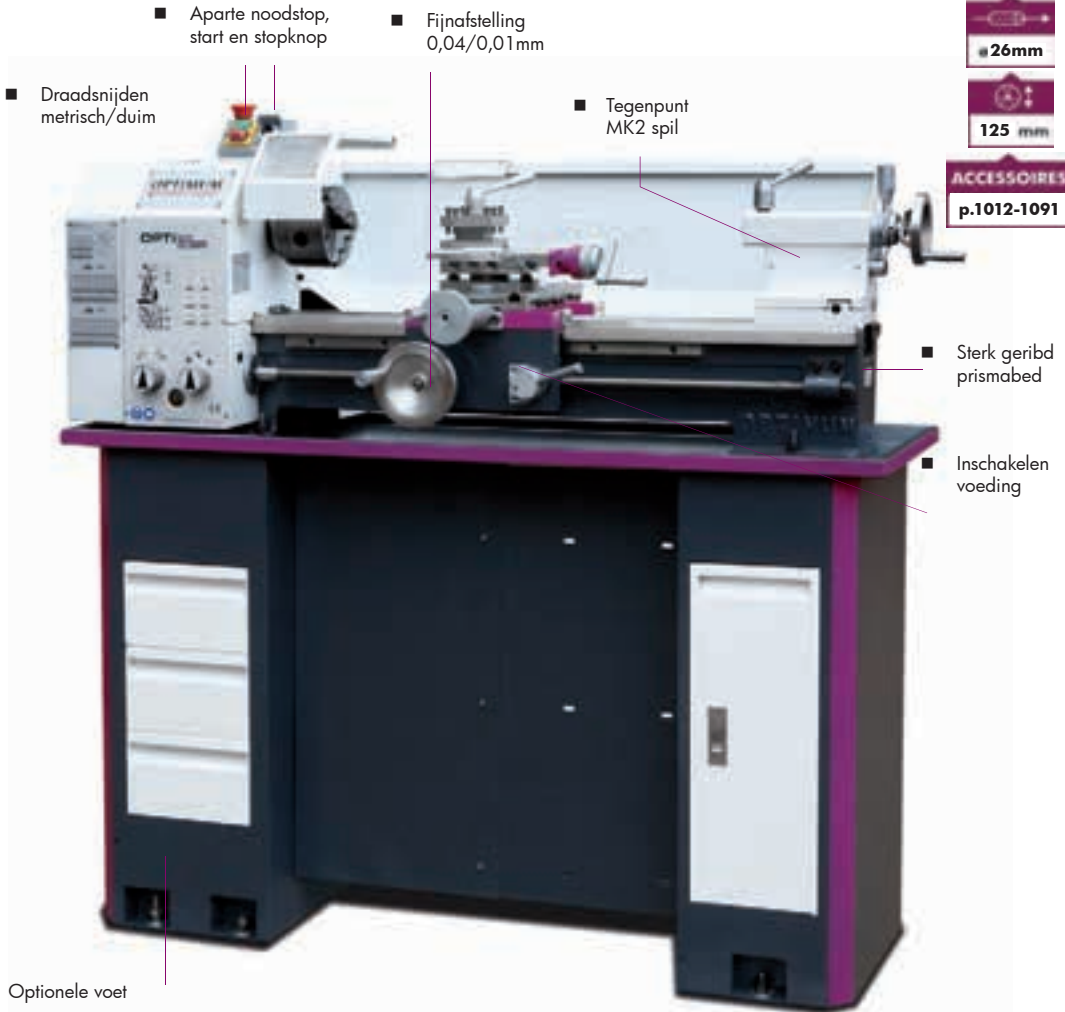
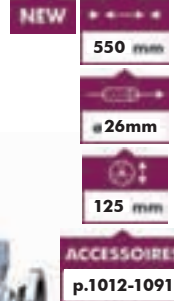

Order nr.	713440409
Orig. nr.	DMV
Gewicht	kg 45,00
Prijs	€ 359,00

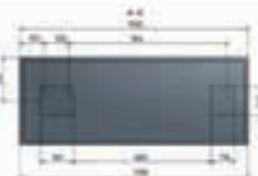
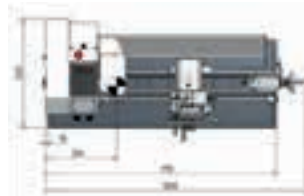
**Standaard geleverd met :**

- Klauwplaat met 3 klauwen 125 mm
- Vast centerpunt MK2
- Vast centerpunt MK3
- Klauwplaat- en beitel afscherming, spatwand en spanenbak
- 4-voudige beitelhouder

- Wisselwielen set.
- Bedieningsleutels
- Sokkel niet inbegrepen 713440409
- Nederlandstalige handleiding, opschriften, CE kenmerk, en CE-attest volgens Machine richtlijn 2006/42/CE, Laagspanningsrichtlijn 2006/95/CE en EMC Richtlijn 2004/108/CE

OPTI

Hoge precieze draaibank voor de veeleisende gebruiker. Vario uitvoering met frequentieomvormer.

- Inductie geharde en precisie geslepen prismabed geleidingen
- Gegarandeerde rondloop nauwkeurigheid van de spilneus beter dan 0,009 mm
- 4 traps variabele toerentalregeling via frequentieomvormer van 30 - 4000 min (enkel voor Vario model).
- Digitale weergave van spilsnelheden (enkel voor Vario model)
- Hoge en precieze afwerkingsgraad
- Lichtlopende aanvoeraandrijving met afgeronde tandwielen, lopend in een oliebad.
- Keuzeschakelaar rechts – linksdraaiend
- Aparte noodstop en aparte start/stopknop
- Voor vlakdraaien, langsdraaien, kegeldraaien en draadsnijden.
- Rolgewalste trapezium leispindel wordt ondersteund door 2 gesinterde lagers.
- Kegellagers in kwaliteit klasse P5
- Druklagers
- Sterk geribd prismabed van gietstaal, inductie gehard en fijn geslepen.
- Klauwplaat afscherming met microscharnelaar, degelijke beetel afscherming en mooie spatwand
- Losse kop kan +- 5 mm verschoven worden voor het draaien van kegels.
- Door een wisselwielen set een groot bereik bij het draadsnijden.
- Met een voedingsas voor draadsnijden of het automatisch langsdraaien.
- Krachtige, onderhoudsvrije motor.
- Geconstrueerd volgens DIN8606.
- Andere voltages mogelijk op aanvraag 3x220V/50Hz en 3x440V/60Hz Opmerking: 3x220V = krachtstroom (drijfkracht). Dit is niet hetzelfde als 1x230V mono = wisselstroom.

Order nr.		713427001 ^M	713427003 ^M	713427006 ^M
Orig. nr.		TU2807-230V	TU2807-400V	TU2807V
Elektrische aansluiting				
Spanning	V	1x230	3x400	1x230
Vermogen motor	kW	0,85	0,85	1,5
Capaciteit				
Centerhoogte	mm	140	140	140
Centerafstand	mm	700	700	700
Draaidiameter boven bed	mm	266	266	266
Draailengte in de bedbrug	mm	180	180	180
Bedbreedte	mm	180	180	180
Kop				
Aantal snelheden		6	6	4 traploos
Spindeltoerental	min-1	150-2.000	150-2.000	30-4.000
Spilkonus	MK	4	4	4
Spilboring	mm	26	26	26
Draadstappen en voeding				
Langsvoeding	mm/O	0,07-0,2	0,07-0,2	0,07-0,2
Draadsnijden metrisch	M	0,2-3,5	0,2-3,5	0,2-3,5
Draadsnijden duim	Gg/1"	56-8	56-8	56-8
Geleiding en wagen				
Rijweg beetelslede	mm	60	60	60
Rijweg dwarslede	mm	160	160	160
Hoogte beetelhouder	mm	13,5	13,5	13,5
Losse kop				
Konus losse kop	MK	2	2	2
Koers losse kop	mm	85	85	85
Gewicht	kg	202,00	202,00	202,00
Afmetingen (l x b x h)	mm	1370 x 640 x 535	1370 x 640 x 535	1370 x 660 x 440
Prijs	€	2.190,00	2.249,00	2.750,00

TU2807/TU2807V

- Hoofdspindel gehard in nastelbare kegelrollagers P5 klasse

- Voedignsaandrijving in oliebad

NEW

700 mm

ø26mm

140 mm

ACCESSOIRES
p.1012-1091



- MK2

- Sterk geribd bed

- Optionele voet

Order nr.	713440409	
Orig. nr.	DMV	
Gewicht	kg	45,00
Prijs	€	359,00

Standaard geleverd met :

- Klauwplaat met 3 klauwen 125 mm
- Vast centerpunt MK2
- Vast centerpunt MK4
- Meenemer
- Klauwplaat- en beitel afscherming, spatwand en spanenbak
- 4-voudige beitelhouder

- Wisselwielen set
- Bedieningsleutels
- Afnameprotocol
- Nederlandstalige handleiding, opschriften, CE kenmerk, en CE-attest volgens Machine richtlijn 2006/42/CE, Laagspanningsrichtlijn 2006/95/CE en EMC Richtlijn 2004/108/CE.



Compleet uitgeruste lei- en voedingsas draaibank met een in olie lopende transmissie. DPA-versie met digitale positieaanduiding DPA2000 op 3 assen.

- Inductie geharde en precisie geslepen prismabed geleidingen
- Camlock spilneus volgens DIN55029 / DIN ISO 702-2 Nr. 4
- Gegarandeerde rondlooptrouwbaarheid van de spilneus beter dan 0,015 mm
- Elektrische componenten van Siemens
- Alle geleidingen door spieën na stelbaar.
- Uitteembaar bedbrug voor het draaien van grotere diameters.
- Hoge en precieze afwerkingsgraad
- Lichtlopende aanvoeraandrijving met afgeronde tandwielen, lopend in een oliebad.
- Digitale uitlezing DPA2000 op 3 assen gemonteerd (enkel DPA versie).
 - * Duidelijke vermindering van de insteltijden
 - * Eenvoudige bediening
 - * Hogere arbeidsnauwkeurigheid
 - * Foutenmarge wordt drastisch gereduceerd
 - * Gebruiksvriendelijk toetsenbord
 - * Reflectievrije display
- Keuzeschakelaar rechts – linksdraaiend
- Aparte noodstop en aparte start/stopknop
- Rolgewalste trapezium leispindel wordt ondersteund door 2 gesinterde lagers.
- Klauwplaat afscherming met microschatelaar, degelijke beitel afscherming, leispilafscherming en mooie spatwand
- Losse kop kan +/- 10 mm verschoven worden voor het draaien van kegels.
- Door een wisselwielen set een groot bereik bij het draadsnijden.
- Met een voedingsas voor draadsnijden of het automatisch langsdraaien.
- Krachtige, onderhoudsvrije motor.

Order nr.	713400923	713400926	713400928
Orig. nr.	D320X920 400V	D320X920 DPA-230V	D320X920 DPA-400V
Capaciteit			
Centerhoogte	mm	160	160
Centerafstand	mm	920	920
Draaidiameter boven bed	mm	320	320
Draaidiameter boven slede	mm	190	190
Draaidiameter zonder bedbrug	mm	430	430
Draailengte in de bedbrug	mm	230	230
Bedbreedte	mm	181	181
Kop			
Aantal snelheden		18	18
Spindeltoerental	min-1	65-1800	65 - 1.800
Spilkonus	MK	5	5
Spilneus Camlock DIN55029		D1-4"	D1-4"
Spilboring	mm	38	38
Draadstappen en voeding			
Langsvoeding	mm/O	0,052-1,392	0,052-1,392 (32)
Dwarsvoeding	mm/O	0,014-0380	0,014-0380 (32)
Draadsnijden metrisch	M	0,4-7	0,4-7 (26)
Draadsnijden duim	Gg/1"	56-4	56-4 (34)
Geleiding en wagen			
Rijweg beitel slede	mm	85	85
Rijweg dwars slede	mm	162	162
Hoogte beitelhouder	mm	16	16
Losse kop			
Konus losse kop	MK	3	3
Koers losse kop	mm	100	100
Elektrische aansluiting			
Spanning	V	3x400	1x230
Vermogen motor	kW	1,1	1,5
Gewicht	kg	410,00	410,00
Afmetingen (l x b x h)	mm	1680 x 760 x 1420	1685 x 750 x 1550
Prijs	€	4.090,00	5.190,00
			4.990,00

D320x920/D320x920 DPA

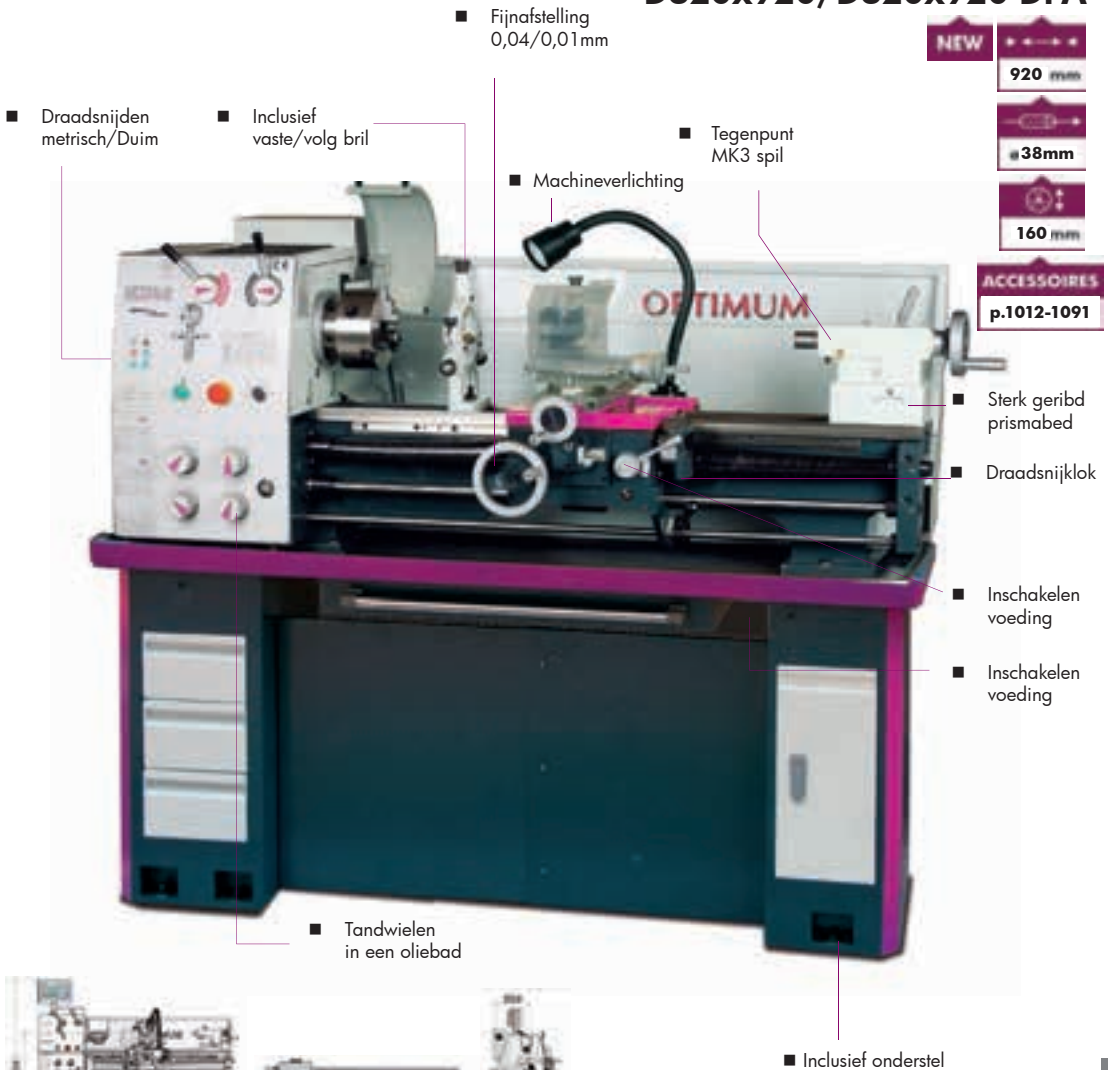
**Standaard geleverd met :**

- Zelfcentrerende klauwplaat met 3 klauwen \varnothing 160 mm rechtstreekse koppeling directe montage (zonder gebruik van flens)
- Onafhankelijke vierbekken plaat \varnothing 200 mm rechtstreekse koppeling directe montage (zonder gebruik van flens)
- Vlakplaat \varnothing 250 mm
- Reductiehuls MK5 - MK3
- 2 Vaste centers MK3
- Vaste bril met doorlaat van maximum 70 mm
- Volg bril met doorlaat van maximum 50 mm
- Plaat stalen machineonderstel (niet gemonteerd)
- Klauwplaat- en beitel afscherming, spatwand en spanenbak

- 4-voudige beitelhouder
- Draadsnijlklok
- Halogeen machineverlichting
- Wisselwielen set
- Eerste vulling met hoogwaardige Mobil olie – vaste kop – Mobilgear 627, transmissie Mobilgear 629.
- Bedieningsleutels
- Afnameprotocol
- Nederlandstalige handleiding, opschriften, CE kenmerk, en CE-attest volgens Machine richtlijn 2006/42/CE, Laagspanningsrichtlijn 2006/95/CE en EMC Richtlijn 2004/108/CE

Montage en ingebruikname machine zijn niet inbegrepen.



Compleet uitgeruste lei- en voedingsas draaibank met elektronisch regelbare toerentalregeling en digitale positieaanduiding DPA2000S op 3 assen.

Argumenten, die in kwaliteit, prestatie en prijs overtuigen:

- Geharde en geslepen prismabed geleidingen
- Hoge en precieze afwerkinggraad
- Sterk geribd prismabed uit grijsgietijzer, inductie gehard en precisie geslepen
- Geharde spilneus en gelagerd in na stelbare kegelkogellagers klasse P5 kwaliteit.
- Gegarandeerde rondloop nauwkeurigheid van de spilneus beter dan 0,015 mm
- Rechts / linkslopend omschakelbaar op het bedienpaneel. Aparte noodstop, aparte start en stopknop. Nullast spanning.
- Klauwplaat afscherming met microscharakelaar. Degelijke beetel afscherming op de wagen gemonteerd en mooie spatwand. Leispilafscherming rond de leispindel.
- Voorzien van druklager op de dwars (voor het opnemen van axiale krachten)
- Leispindel in twee sinterlagers (glijlagers met olie, die geen smering meer vereisen)
- Door een wisselwielen set een groot bereik bij het draad snijden.
- **9 traploos regelbare spilsnelheden 12 - 2250 min-1 .**
- **Digitale aflezing DPA2000S over 3 glaslinialen met digitale weergave van de spilsnelheden:** Duidelijke vermindering van de insteltijden, Hogere arbeidsnauwkeurigheid, Foutenmarge wordt gereduceerd
- Losse kop kan +- 10 mm verplaatst worden voor het draaien van kegels, met snelklemming van de losse kop voor een nog betere klemming
- Alle geleidingen door middel van spelijsen zonder speling na stelbaar.
- Krachtige, onderhoudsvrije motor.
- Mooie, degelijke plaatstalen onderstel met 3 lades en opbergvak.

Order nr.		713403110
Orig. nr.		TU3209V
Capaciteit		
Centerhoogte	mm	160
Centerafstand	mm	920
Draaidiameter boven bed	mm	320
Draaidiameter boven slede	mm	190
Draaidiameter zonder bedbrug	mm	430
Draailengte in de bedbrug	mm	230
Bedbreedte	mm	181
Kop		
Aantal snelheden		9 traploos
Spindeltoerental	min-1	12:2250
Spilkonus	MK	5
Spilneus Camlock DIN55029		D1-4"
Spilboring	mm	38
Draadstappen en voeding		
Langsvoeding	mm/O	0.052-1392 (32)
Dwarsvoeding	mm/O	0.014-0.380 (32)
Draadsnijden metrisch	M	0.47 (26)
Draadsnijden duim	Gg/1"	56.4 Gg/1" (34)
Geleiding en wagen		
Rijweg beetelslede	mm	85
Rijweg dwarslede	mm	162
Hoogte beetelhouder	mm	16x16
Losse kop		
Konus losse kop	MK	3
Koers losse kop	mm	100
Elektrische aansluiting		
Spanning	V	1x230
Vermogen motor	kW	1.5
Gewicht	kg	410,00
Afmetingen (l x b x h)	mm	1680 x 750 x 1550
Prijs	€	6.490,00

TU3209V

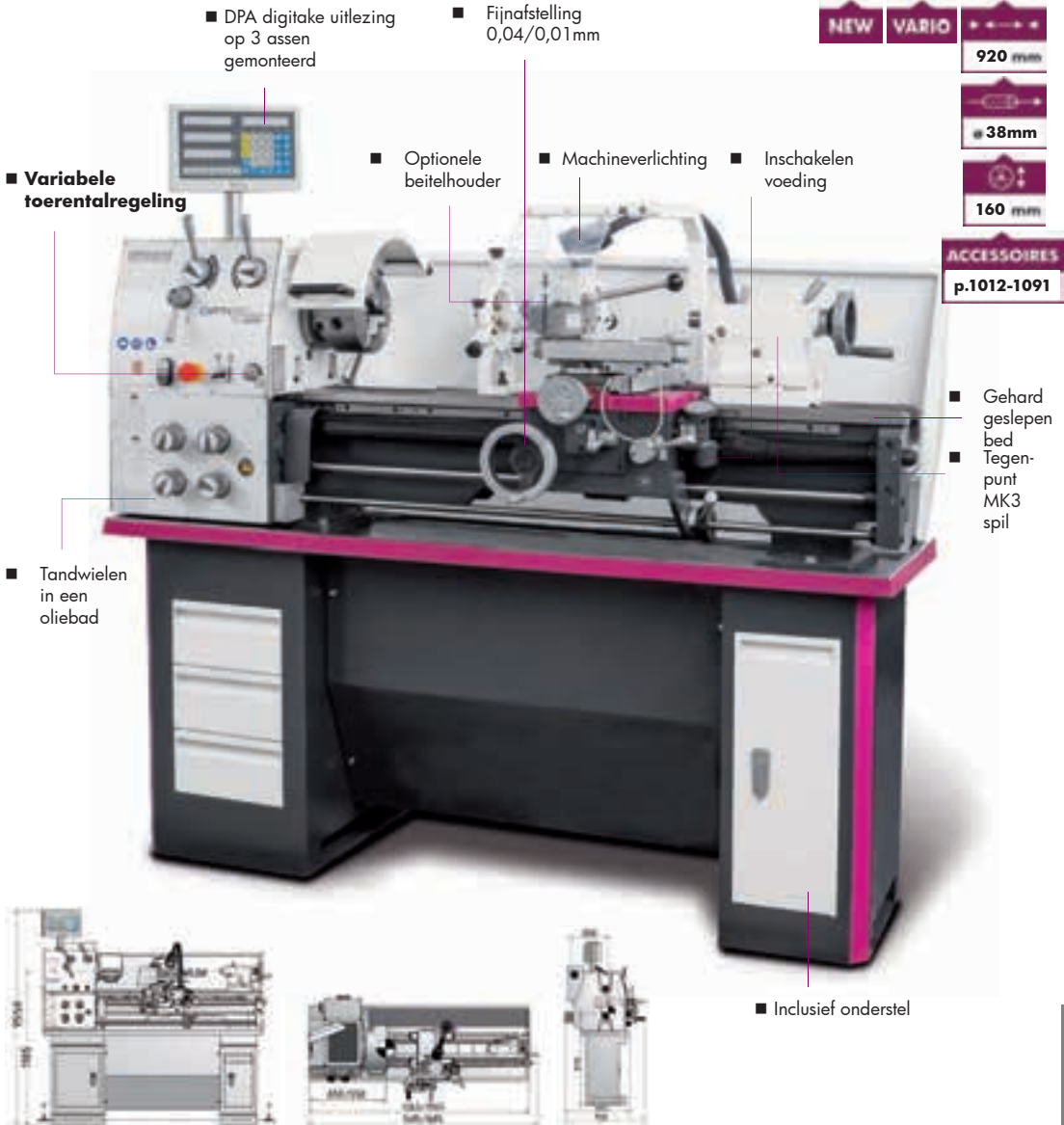

Standaard geleverd met :

- Zelfcenterende klauwplaat met 3 klauwen \varnothing 160 mm rechtstreekse koppeling directe montage (zonder gebruik van flens)
- Onafhankelijke vierbekken plaat \varnothing 200 mm rechtstreekse koppeling directe montage (zonder gebruik van flens)
- Vlakplaat \varnothing 250 mm
- Reductiehuls MK5 - MK3
- 2 Vaste centers MK3
- Vaste bril met doorlaat van maximum 70 mm
- Volg bril met doorlaat van maximum 50 mm
- Plaat stalen machineonderstel (niet gemonteerd)
- Spatwand (niet gemonteerd)
- Klauwplaat- en beitel afscherming

- 4-voudige beitelhoeder
- Draadsnijlklok
- Halogeen machineverlichting
- Wisselwielen set
- Eerste vulling met hoogwaardige Mobil olie – vaste kop – Mobilgear 627, transmissie Mobilgear 629.
- Bedieningsleutels
- Afnameprotocol
- Nederlandstalige handleiding, opschriften, CE kenmerk, en CE-attest volgens Machine richtlijn 2006/42/CE, Laagspanningsrichtlijn 2006/95/CE en EMC Richtlijn 2004/108/CE

Montage en ingebruikname machine zijn niet inbegrepen.



Compleet uitgeruste onderhoudsdraaibank met gesloten aanvoeraandrijving voor snel en bekwaam omschakelen van de aanvoersnelingen.. DPA-versie met digitale positieaanduiding DPA2000 op 3 assen.

- Inductie geharde en precisie geslepen prismabed geleidingen
- Camlock spilneus volgens DIN55029 / DIN ISO 702-2 Nr. 4
- Gegarandeerde rondloopnauwkeurigheid van de spilneus beter dan 0,015 mm
- Elektrische componenten van Siemens
- Alle geleidingen door spieën na stelbaar.
- Uitneembaar bedbrug voor het draaien van grotere diameters.
- Hoge en precieze afwerkingsgraad
- Lichtlopende aanvoeraandrijving met afgeronde tandwielen, lopend in een oliebad.
- **Digitale uitlezing DPA2000 op 3 assen gemonteerd (enkel DPA versie).**
 - Duidelijke vermindering van de insteltijden
 - Eenvoudige bediening
 - Hogere arbeidsnauwkeurigheid
 - Foutenmarge wordt drastisch gereduceerd
 - Gebruiksvriendelijk toetsenbord
 - Reflectievrije display
- Keuzeschakelaar rechts – linksdraaiend
- Aparte noodstop en aparte start/stopknop
- Rolgewalste trapezium leispindel wordt ondersteund door 2 gesinterde lagers.
- Klauwplaat afscherming met microscharnelaar, degelijke beetel afscherming, leispilafscherming en mooie spatwand
- Losse kop kan +- 10 mm verschoven worden voor het draaien van kegels.
- Door een wisselwielen set een groot bereik bij het draadsnijden.
- Met een voedingsas voor draadsnijden of het automatisch langsdraaien.
- Krachtige, onderhoudsvrije motor.

Order nr.		713401000	713401008
Orig. nr.		D330X1000	D330X1000 DPA
Capaciteit			
Centerhoogte	mm	165	165
Centerstand	mm	1000	1000
Draaidiameter boven bed	mm	330	330
Draaidiameter boven slede	mm	198	198
Draaidiameter zonder bedbrug	mm	516	516
Draailengte in de bedbrug	mm	210	210
Bedbreedte	mm	187	187
Kop			
Aantal snelheden		8	8
Spindeltoerental	min-1	70-2000	70-2000
Spilkonus	MK	5	5
Spilneus Camlock DIN55029		D1-4"	D1-4"
Spilboring	mm	38	38
Draadstappen en voeding			
Langsvoeding	mm/O	0.082/2711	0,082/2,711
Dwarsvoeding	mm/O	0.018-0.583	0,018-0,583
Draadsnijden metrisch	M	0.4-7	0,4-7
Draadsnijden duim	Gg/1"	56-4	56-4
Trapeziumdraad	D.P.	8-120	8-120
Modulaire draad	M.P.	0.2-3.5	0,2-3,5
Geleiding en wagen			
Rijweg beetelslede	mm	95	95
Rijweg dwarslede	mm	170	170
Hoogte beetelhouder	mm	16	16
Losse kop			
Konus losse kop	MK	3	3
Koers losse kop	mm	100	100
Elektrische aansluiting			
Spanning	V	3x400	3x400
Vermogen motor	kW	1,5/2,4	1,5/2,4
Gewicht	kg	520,00	520,00
Afmetingen (l x b x h)	mm	1930 x 760 x 1450	1930 x 760 x 1450
Prijs	€	4.990,00	5.900,00

D330x1000/D330x1000DPA

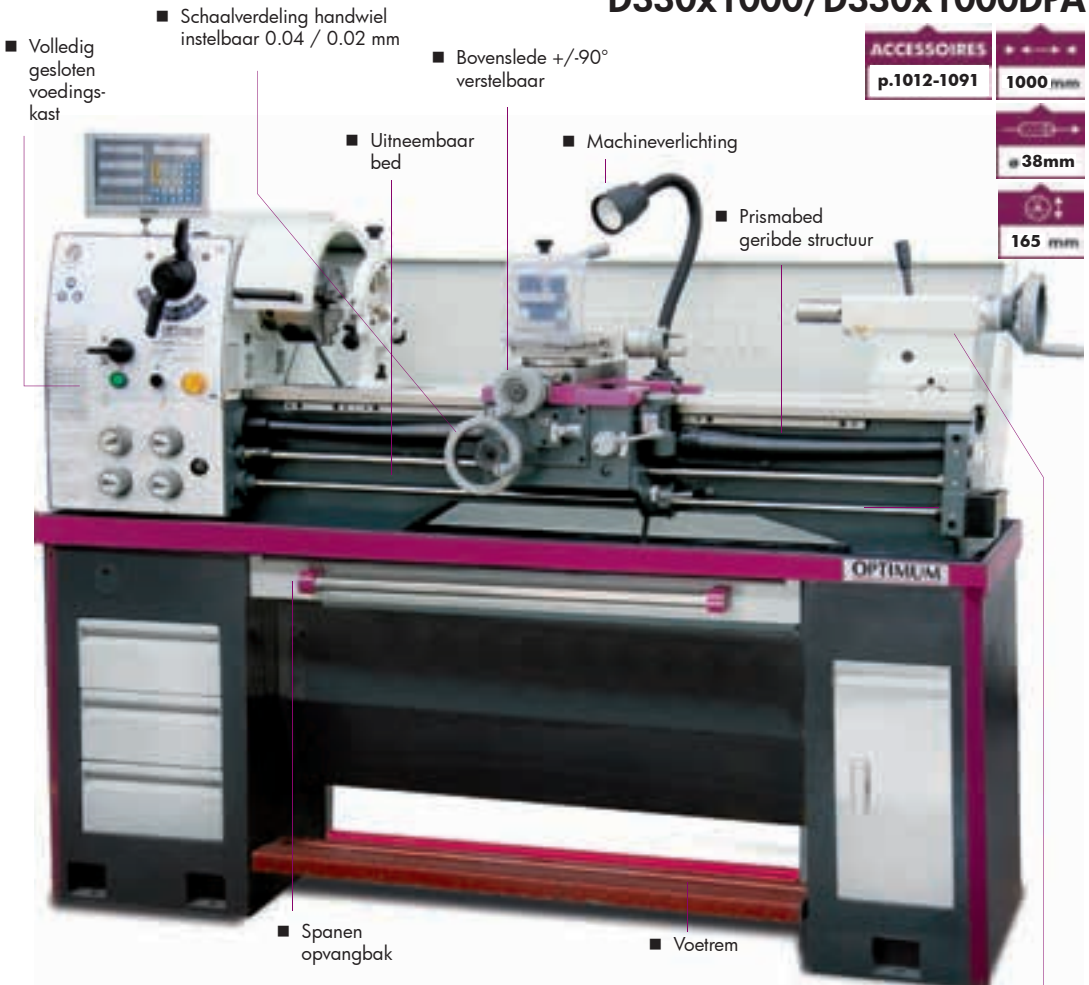

ACCESSOIRES

p.1012-1091

1000 mm

38mm

165 mm

- Volledig gesloten voedingskast
- Schaalverdeling handwiel instelbaar 0.04 / 0.02 mm
- Bovenslede +/-90° verstelbaar
- Uitteembaar bed
- Machineverlichting
- Prismabed geribde structuur
- Spanen opvangbak
- Voetrem
- Tegenpunt MK3 +/- 10mm verstelbaar

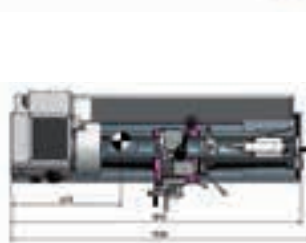
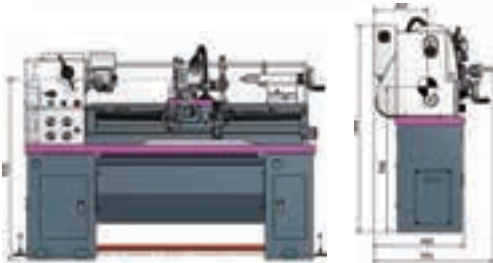
**Standaard geleverd met :**

- Zelfcentrerende klauwplaat met 3 klauwen \varnothing 160 mm rechtstreekse koppeling directe montage (zonder gebruik van flens)
- Onafhankelijke vierbekken plaat \varnothing 200 mm rechtstreekse koppeling directe montage (zonder gebruik van flens)
- Vlakplaat \varnothing 250 mm
- Reductiehuls MK5 - MK3
- 2 Vaste centers MK3
- Vaste bril met doorlaat van maximum 100 mm
- Volg bril met doorlaat van maximum 95 mm
- Plaat stalen machineonderstel (gemonteerd)
- Klauwplaat- en beitel afscherming, spatwand en spanenbak

- 4-voudige beitelhouder
- Draadsnijlklok
- Halogeen machineverlichting
- Wisselwielen set
- Eerste vulling met hoogwaardige Mobil olie – vaste kop – Mobilgear 627, transmissie Mobilgear 629.
- Bedieningsleutels
- Afnameprotocol
- Nederlandstalige handleiding, opschriften, CE kenmerk, en CE-attest volgens Machine richtlijn 2006/42/CE, Laagspanningsrichtlijn 2006/95/CE en EMC Richtlijn 2004/108/CE

Montage en ingebruikname machine zijn niet inbegrepen.



Compleet uitgeruste precisie lei- en voedingsas draaibank met gesloten aanvoeraandrijving voor snel en bekwaam omschakelen van de aanvoerversnellingen.

- Inductie geharde en precisie geslepen prismabed geleidingen
- Camlock spilneus ASA D1-4" volgens DIN55029
- Alle geleidingen door spieën na stelbaar.
- Uitneembaar bedbrug voor het draaien van grotere diameters.
- Bovenslede is onder +/-90° verstelbaar.
- Plaatstalen machineonderstel met twee afsluitbare deuren met opbergmogelijkheden
- Hoge en precieze afwerkingsgraad
- Geharde en geslepen tandwielen en assen, precisielopend in een oliebad.
- **Digitale uitlezing DPA2000 op 3 assen gemonteerd.**
- Keuzeschakelaar rechts
 - linksdraaiend - Aparte noodstop en aparte start/stopknop
 - Klauwplaat afscherming met microscharakelaar, degelijke beitel afscherming, leispilafscherming en mooie spatwand
- Mechanische noodstop – voetrem
- **Gesloten koelvoelstofsysteem met aparte koelpomp**
- Losse kop kan +/- 5 mm verschoven worden voor het draaien van kegels.
- Door een wisselwielen set een groot bereik bij het draadsnijden.
- Met een voedingsas voor draadsnijden of het automatisch langsdraaien.
- Krachtige, onderhoudsvrije motor.

Order nr.		713401158
Orig. nr.		D360X1000 DPA
Capaciteit		
Centerhoogte	mm	180
Centerafstand	mm	1000
Draaidiameter boven bed	mm	356
Draaidiameter boven slede	mm	220
Draaidiameter zonder bedbrug	mm	516
Draailengte in de bedbrug	mm	240
Bedbreedte	mm	205
Kop		
Aantal snelheden		16
Spindeltoerental	min-1	45-1800
Spilkonus	MK	5
Spilneus Camlock DIN55029		D1-4"
Spilboring	mm	38
Draadstappen en voeding		
Langsvoeding	mm/O	0,043-0,653 (42)
Dwarsvoeding	mm/O	0,015-0,220 (42)
Draadsnijden metrisch	M	0,45-7,5 (37)
Draadsnijden duim	Gg/1"	112-4 (28)
Trapeziumdraad	D.P.	8 - 120
Modulaire draad	M.P.	0,2 - 3,5
Geleiding en wagen		
Rijweg beitel slede	mm	95
Rijweg dwarslede	mm	180
Hoogte beitelhouder	mm	16
Losse kop		
Konus losse kop	MK	3
Koers losse kop	mm	126
Elektrische aansluiting		
Spanning	V	3x400
Vermogen motor	kW	1,5/2,4
Vermogen motor koelpomp	W	40
Gewicht	kg	750,00
Afmetingen (l x b x h)	mm	1920 x 800 x 1490
Prijs	€	7.790,00

D360x1000DPA

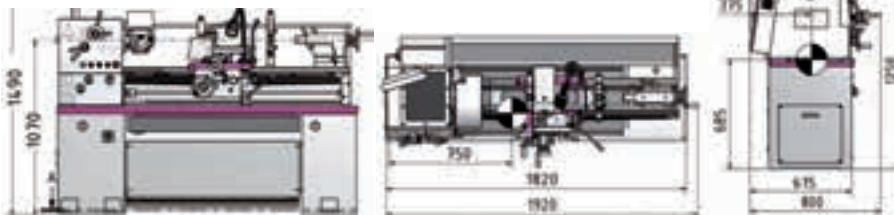
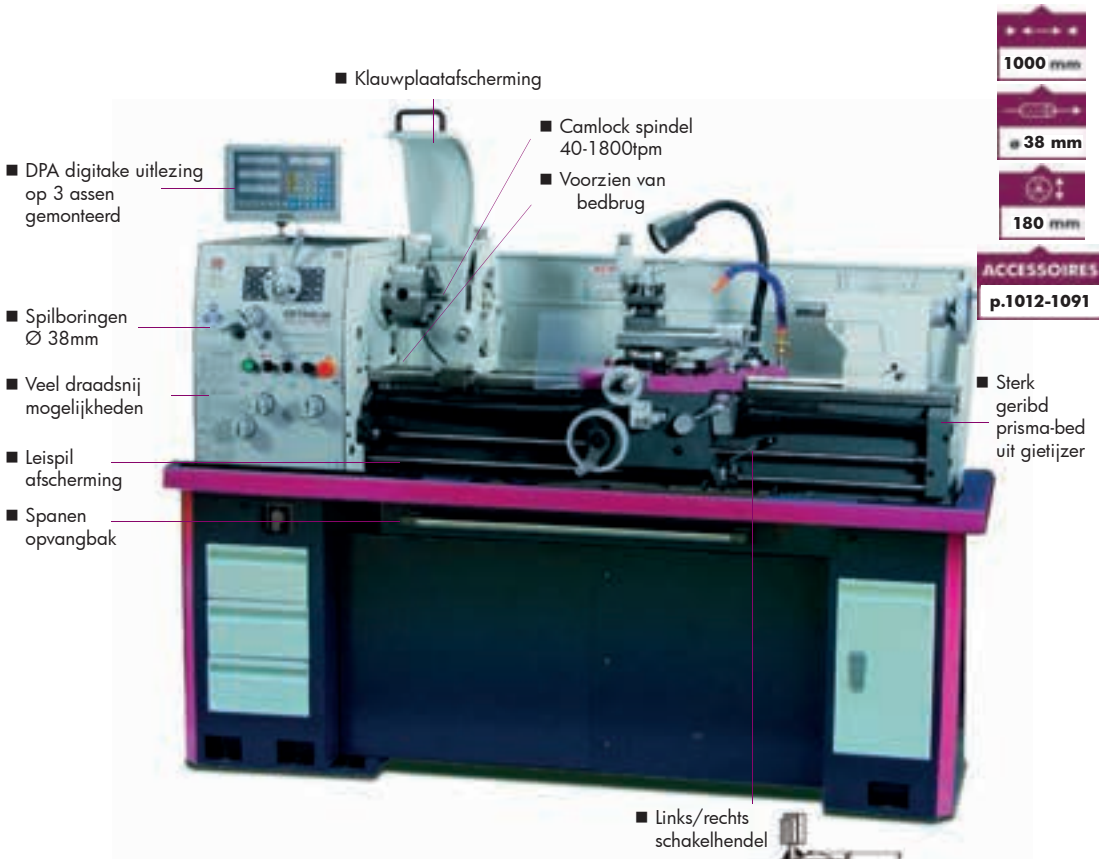
**Standaard geleverd met :**

- Digitale uitlezing DPA2000 op 3 assen gemonteerd
- Gesloten koelvloeistofstelsel met koelpomp
- Zelfcentrerende klauwplaat met 3 klauwen \varnothing 160 mm rechtstreekse koppeling directe montage (zonder gebruik van flens)
- Onafhankelijke vierbekken plaat \varnothing 200 mm rechtstreekse koppeling directe montage (zonder gebruik van flens)
- Vlakplaat \varnothing 320 mm
- Reductiehuls MK5-MK3
- 2 Vaste centers MK3
- Vaste bril met doorlaat van maximum 100 mm
- Volg bril met doorlaat van maximum 95 mm
- Plaat stalen machineonderstel (gemonteerd)
- Klauwplaat- en beitel afscherming, spatwand en spanenbak

- Mechanische voetrem pedaal
- 4-voudige beitelhouder
- Draadsnijblok
- Halogeen machineverlichting
- Wisselwielen set
- Eerste vulling met hoogwaardige Mobil olie
- vaste kop
- Mobilgear 627, transmissie Mobilgear 629.
- Bedieningsleutels
- Afnameprotocol
- Nederlandstalige handleiding, opschriften, CE kenmerk, en CE-attest volgens Machine richtlijn 2006/42/CE, Laagspanningsrichtlijn 2006/95/CE en EMC Richtlijn 2004/108/CE Montage en ingebruikname machine zijn niet inbegrepen.



Compleet uitgeruste precisie lei- en voedingsas draaibank met **Siemens inverter** vario aandrijving en digitale positieaanduiding DPA2000S op 3 assen.

Argumenten, die in kwaliteit, prestatie en prijs overtuigen:

- Spindelopname Camlock DIN ISO 702:2 Nr. 4
- Toerentalbewaking volgens de machinerichtlijn. EMV filter klasse 2 voor de inzet in verschillende gebieden
- **Koelmiddelrichting met afzonderlijke koeltank**, met niveau indicator en olieafscheider, gemakkelijke en volledige reiniging mogelijk, volgens DIN.
- Gegarandeerde rondloop nauwkeurigheid van de spilneus beter dan 0,015 mm
- Tandwielen en assen zijn gehard en geslepen, lopend in een oliebad met precisie lagers
- Aparte noodstop, motorbeveiliging en vergrendelbare hoofdschakelaar. Rechts / links lopend door middel van hendel aan de wagen
- **40 positie snelwissel beitelhoeder met 1 beitelhoeder voor vierkante beitels.**
- Halogeen machineverlichting
- Nieuwe plaatstalen machine onderstel met 3 aparte lades en opbergvak
- De elektrische routing loopt in een kabelgoot, dus geen loshangende kabels in de koelvloeistof, alsook een mooie geleidingen van de elektrische kabels van de wagen. Elektrische uitrusting met Siemens componenten
- Sterk geribd prismabed uit grijsgietijzer, inductie gehard en precisie geslepen
- Geharde spilneus en gelagerd in na stelbare kegelkogellagers klasse P5 kwaliteit.
- Klauwplaat afscherming met microscharnelaar. Degelijke beitel afscherming op de wagen gemonteerd en mooie spatwand. Leispilafscherming rond de leispindel.
- Voorzien van druklager op de dwars (voor het opnemen van axiale krachten). Leispindel in twee sinterlagers (glijlagers met olie, die geen smering meer vereisen)
- 2 traps elektronisch regelbare spilsnelheden 30 - 550 / 160 - 3000 min⁻¹
- **Digitale aflezing DPA2000S over 3 glaslinialen met digitale weergave van de spilsnelheden:** Duidelijke vermindering van de insteltijden, Hogere arbeidsnauwkeurigheid, Foutenmarge wordt gereduceerd, Digitale weergave van de spilsnelheden
- Losse kop kan +- 6 mm verplaatst worden voor het draaien van kegels, met snelklemming van de losse kop voor een nog betere klemming
- Uiterst krachtige, onderhoudsvrije motor van 4 kW.

Order nr.	713403130	
Orig. nr.	TU3610V	
Capaciteit		
Centerhoogte	mm	180
Centerafstand	mm	1000
Draaidiameter boven bed	mm	356
Draaidiameter boven slede	mm	220
Draaidiameter zonder bedbrug	mm	516
Draailengte in de bedbrug	mm	240
Bedbreedte	mm	205
Kop		
Aantal snelheden		traploos (2 traps)
Spindeltoerental	min-1	30-550/160-3000
Spilkonus	MK	5
Spilneus Camlock DIN55029		D1-4"
Spilboring	mm	38
Draadstappen en voeding		
Langsvoeding	mm/O	0.043-0.653 (42)
Dwarsvoeding	mm/O	0.015-0.220 (42)
Draadsnijden metrisch	M	0.45-7.5 (37)
Draadsnijden duim	Gg/1"	11.24 (28)
Geleiding en wagen		
Rijweg beitelslede	mm	95
Rijweg dwarslede	mm	180
Hoogte beitelhoeder	mm	16x16
Losse kop		
Konus losse kop	MK	3
Koers losse kop	mm	126
Elektrische aansluiting		
Spanning	V	3x400
Vermogen motor	kW	4
Vermogen motor koelpomp	W	40
Gewicht	kg	750,00
Afmetingen (l x b x h)	mm	1920 x 800 x 1250
Prijs	€	12.190,00

TU3610V

- Wagen: - Precies bewerkt
- Handwielen instelbaar met fijn afstelling 0,04/0,02mm
- Alle geleidingen nastelbaar met spieën

- Digitale aflezing DPA2000S op 3 assen

- Hoofdspindel:
 - Gehard en geslepen
 - In een oliebad
 - Met 2 instelbare precisie kegellagers
 - Hoogwaardige GATES aandrijfriemen

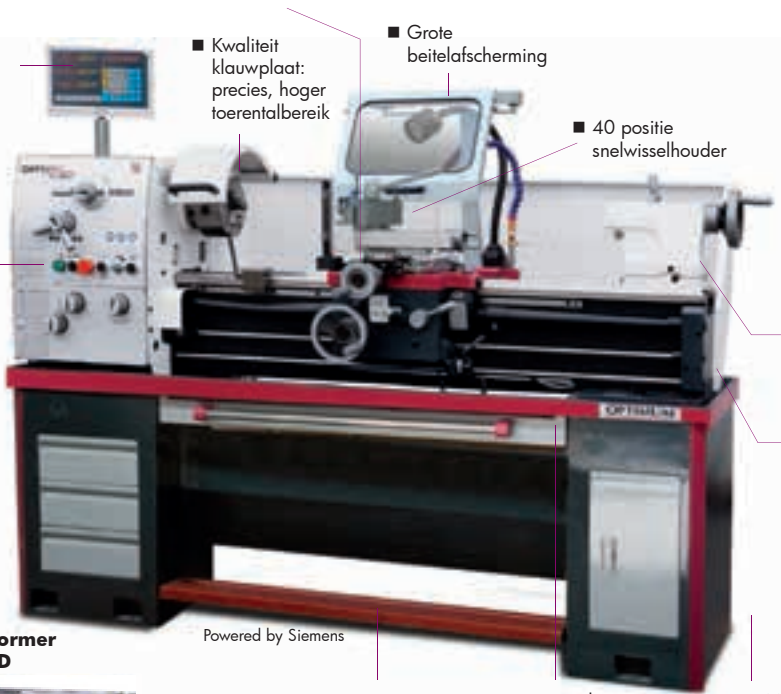

- Kwaliteit klauwplaat: precies, hoger toerentalbereik

- Grote beetelafscherming

- 40 positie snelwisselhouder

- Tegenpunt MK3 +/- 6mm verstelbaar

- Leispindel en moerwijs voorzien van sinterlagers

Frequentieomvormer Sinamics G120D

Powered by Siemens



- Voetrem

- Uitneembare spanen opvangbak

- Modern machineonderstel met opbergvakken

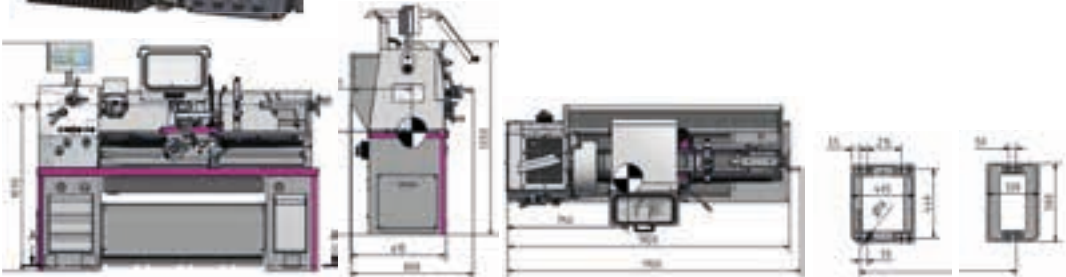

Standaard geleverd met :

- Zelfcenterende klauwplaat met 3 klauwen \varnothing 160 mm rechtstreekse koppeling directe montage (zonder gebruik van flens)
- Onafhankelijke vierbekken plaat \varnothing 200 mm rechtstreekse koppeling directe montage (zonder gebruik van flens)
- Vlakplaat \varnothing 320 mm
- Reductiehuls MK5 - MK3
- 2 Vaste centers MK3
- Vaste bril met doorlaat van maximum 100 mm
- Volg bril met doorlaat van maximum 95 mm
- Plaat stalen machineonderstel (gemonteerd)
- Spatwand (gemonteerd)
- Klauwplaat- en beetel afscherming
- 40 positie snelwissel beetelhouder met 1 vierkante

- beetelhouder
- Koelvloeistofsysteem
- Draadsnijblok
- Halogeen machineverlichting
- Wisselwielen set
- Eerste vulling met hoogwaardige Mobil olie – vaste kop – Mobilgear 627, transmissie Mobilgear 629.
- Bedieningsleutels
- Afnameprotocol
- Nederlandstalige handleiding, opschriften, CE kenmerk, en CE-attest volgens Machine richtlijn 2006/42/CE, Laagspanningsrichtlijn 2006/95/CE en EMC Richtlijn 2004/108/CE

Montage en ingebruikname machine zijn niet inbegrepen.



Precisie lei- en voedingsas draaibank. Uitgekiende techniek en volledig uitgerust.

- Camlock spilneus ASA D1-6" volgens DIN55029
- Alle geleidingen door spieën na stelbaar.
- Uitneembaar bedbrug voor het draaien van grotere diameters.
- In een oliebad lopende hoofdspindel, gehard en geslepen met twee afstelbare precisie kogellagers. Geharde en geslepen tandwielen en assen, precisielopend in een oliebad.
- Alle metrische draadstappen van 0,2 tot 14 mm/omw en alle Withworth draadstappen van 72 – 2 Gg/1"
- Bovenslede is onder +/-90° verstelbaar.
- Uit één stuk gegoten Meehaniet gietijzeren machineonderstel
- Hoge en precieze afwerkingsgraad
- **Digitale uitlezing DPA2000 op 3 assen gemonteerd.**
- **Snelwisselende beitelhoeder SWH5 – B, gemonteerd met 3 vierkant beitelhouders en 1 beitelhoeder voor ronde beitels**
- Keuzeschakelaar rechts – linksdraaiend, aparte noodstop en aparte start/stopknop
- Sterk geribd prismabed van gietstaal (GG30), inductie gehard en fijn geslepen.
- Klauwplaat afscherming met microschakelaar, degelijke beitel afscherming, leispilafscherming en mooie spatwand. Mechanische noodstop – voetrem.
- Gesloten koelvloeistofsysteem met aparte koelpomp
- Losse kop kan +- 13 mm verschoven worden voor het draaien van kegels.
- Door een wisselwiel set een groot bereik bij het draadsnijden.
- Met een voedingsas voor draadsnijden of het automatisch langsdraaien.
- Krachtige, onderhoudsvrije motor 4,5 kW.

Order nr.		713401168	713401169
Orig. nr.		D420X1000 DPA SWH	D420X1500 DPA SWH
Capaciteit			
Centerhoogte	mm	210	210
Centerafstand	mm	1000	1500
Draaidiameter boven bed	mm	420	420
Draaidiameter boven slede	mm	250	250
Draaidiameter zonder bedbrug	mm	590	590
Draailengte in de bedbrug	mm	260	260
Bedbreedte	mm	250	250
Kop			
Aantal snelheden		16	16
Spindeltoerental	min-1	45-1800	45-1800
Spilkonus	MK	6	6
Spilneus Camlock DIN55029		D1-6"	D1-6"
Spilboring	mm	52	52
Draadstappen en voeding			
Langsvoeding	mm/O	0,05-1,7 (17)	0,05-1,7
Dwarsvoeding	mm/O	0,025-0,85 (17)	0,025-0,85
Draadsnijden metrisch	M	0,2-14 (39)	0,2-14 (39)
Draadsnijden duim	Gg/1"	722 (45)	722 (45)
Trapeziumdraad	D.P.	8-44 (21)	8-44 (21)
Modulaire draad	M.P.	0,3-3,5 (18)	0,3-3,5 (18)
Geleiding en wagen			
Rijweg beitelslede	mm	140	140
Rijweg dwarslede	mm	230	230
Hoogte beitelhoeder	mm	20	20
Losse kop			
Konus losse kop	MK	4	4
Koers losse kop	mm	120	120
Elektrische aansluiting			
Spanning	V	3x400	3x400
Vermogen motor	kW	4,5	4,5
Vermogen motor koelpomp	W	100	100
Gewicht	kg	1550,00	1800,00
Afmetingen (l x b x h)	mm	2025 x 915 x 1615	2525 x 915 x 1615
Prijs	€	10.490,00	12.290,00

D420x1000/1500DPA

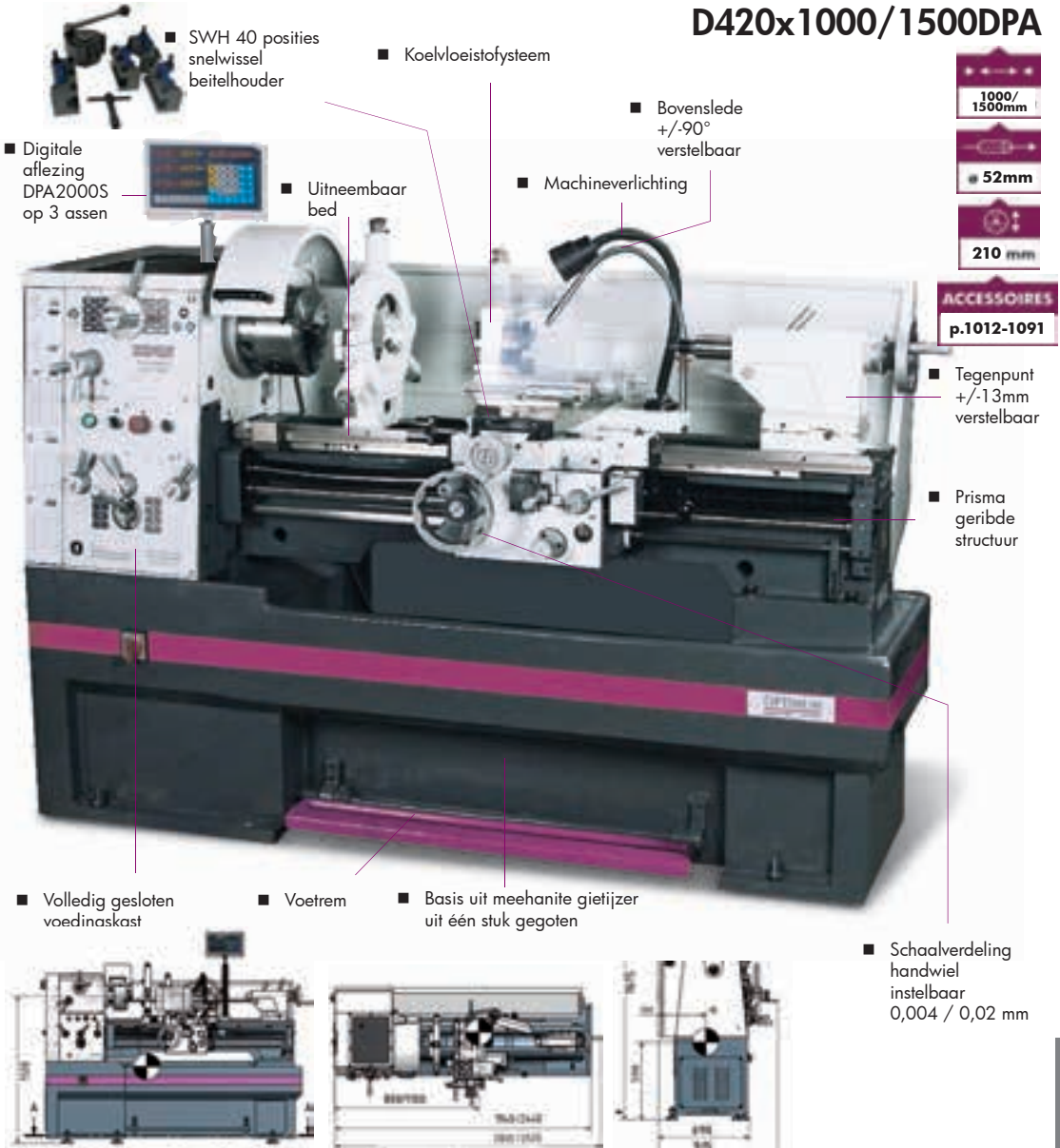

- SWH 40 posities snelwissel beitelhouder
- Koelvloeistofstelsysteem
- Bovenslede +/-90° verstelbaar
- Machineverlichting
- Uitneembaar bed
- Digitale aflezing DPA2000S op 3 assen

- 1000/1500mm
- 52mm
- 210 mm

ACCESSOIRES
p.1012-1091

- Tegenpunt +/-13mm verstelbaar
- Prisma geribde structuur

- Volledig gesloten voedingskast
- Voetrem
- Basis uit meehanite gietijzer uit één stuk gegoten
- Schaalverdeling handwiel instelbaar 0,004 / 0,02 mm

Standaard geleverd met :

- Digitale uitlezing DPA2000 op 3 assen gemonteerd
- Snelwisselende beitelhouder SWH5 – B met 3 vierkant beitelhouders en 1 beitelhouder voor ronde beitels
- Gesloten koelvloeistofstelsysteem met koelpomp
- Zelfcenterende klauwplaat met 3 klauwen \varnothing 200 mm rechtstreekse koppeling directe montage (zonder gebruik van flens)
- Onafhankelijke vierbekken plaat \varnothing 250 mm rechtstreekse koppeling directe montage (zonder gebruik van flens)
- Vlakplaat \varnothing 350 mm
- Reductiehuls MK6-MK4
- 2 Vaste centers MK4
- Vaste bril met doorlaat van maximum 145 mm
- Volg bril met doorlaat van maximum 75 mm

- Gietijzeren machineonderstel
- Klauwplaat- en beitel afscherming, spatwand en spanenbak
- Mechanische voetrem pedaal
- Draadsnijblok
- Halogeen machineverlichting
- Wisselwielen set
- Eerste vulling met hoogwaardige Mobil olie – vaste kop – Mobilgear 627, transmissie Mobilgear 629.
- Bedieningsleutels
- Afnameprotocol
- Nederlandstalige handleiding, opschriften, CE kenmerk, en CE-attest volgens Machine richtlijn 2006/42/CE, Laagspanningsrichtlijn 2006/95/CE en EMC Richtlijn 2004/108/CE. Montage en ingebruikname machine zijn niet inbegrepen.



Compleet uitgeruste precisie lei- en voedingsas draaibank met **Siemens inverter** vario aandrijving en digitale positieaanduiding DPA2000S op 3 assen.

Argumenten, die in kwaliteit, prestatie en prijs overtuigen:

- Geharde en geslepen prismabed geleidingen. **Hoogwaardig gietijzeren onderstel.**

- Spindelopname Camlock DIN ISO 702:2 Nr. 6

- Toerentalbewaking volgens de machinerichtlijn. EMV filter klasse 2 voor de inzet in verschillende gebieden

- Gegarandeerde rondloop nauwkeurigheid van de spilneus beter dan 0,015 mm

- Alle metrische en inch draadsnij mogelijkheden in bereik van 0,2 tot 14 mm/omw. en van 72 tot 2 gangen per inch, kunnen gesneden worden **zonder het omwisselen van tandwielen** door middel van de schakelhendels.

- Tandwielen en assen zijn gehard en geslepen, lopend in een oliebad met precisie lagers

- Aparte noodstop, motorbeveiliging en vergrendelbare hoofdschakelaar. Rechts / links lopend door middel van hendel aan de wagen

- Centraal smeersysteem voor het bed.

- 40 positie snelwissel beitelhouder met 1 beitelhouder voor vierkante beitels.

- Halogeen machineverlichting

- De elektrische routing loopt in een kabelgoot, dus geen loshangende kabels in de koelvloeistof, alsook een mooie geleidingen van de elektrische kabels van de wagen. Elektrische uitrusting met Siemens componenten

- Sterk geribd prismabed uit grijsgietijzer, inductie gehard en precisie geslepen

- Geharde spilneus en gelagerd in na stelbare kegelkogellagers klasse P5 kwaliteit.

- Klauwplaat afscherming met microsckakelaar. Degelijke beitel afscherming op de wagen gemonteerd en mooie spatwand. Leispilafscherming rond de leispindel.

- Voorzien van druklager op de dwars (voor het opnemen van axiale krachten). Leispindel in twee sinterlagers (glijlagers met olie, die geen smering meer vereisen).

- 2 traps elektronisch regelbare spilsnelheden 30 - 550 / 160 - 3000 min-1 .

- **Digitale aflezing DPA2000S over 3 glasinialen met digitale weergave van de spilsnelheden:** Duidelijke vermindering van de insteltijden, Hogere arbeidsnauwkeurigheid, Foutenmarge wordt gereduceerd, Digitale weergave van de spilsnelheden

- Losse kop kan +- 13 mm verplaatst worden voor het draaien van kegels, met snelklemming van de losse kop voor een nog betere klemming

- Uiterst krachtige, onderhoudsvrije motor van 5,5 kW.

Order nr.		713403150
Orig. nr.		TU4210V
Capaciteit		
Centerhoogte	mm	210
Centerafstand	mm	1000
Draaidiameter boven bed	mm	420
Draaidiameter boven slede	mm	250
Draaidiameter zonder bedbrug	mm	590
Draailengte in de bedbrug	mm	260
Bedbreedte	mm	250
Kop		
Aantal snelheden		Traploos (2 traps)
Spindeltoerental	min-1	30-550/160-3000
Spilkonus	MK	6
Spilneus Camlock DIN55029		D1-6"
Spilboring	mm	52
Draadstappen en voeding		
Langsvoeding	mm/O	0.05-1.7
Dwarsvoeding	mm/O	0.025-0.85
Draadsnijden metrisch	M	0.2-14
Draadsnijden duim	Gg/1"	722
Trapeziumdraad	D.P.	8-44
Modulaire draad	M.P.	0.3-3.5
Geleiding en wagen		
Rijweg beitel slede	mm	140
Rijweg dwars slede	mm	230
Hoogte beitelhouder	mm	20x20
Losse kop		
Konus losse kop	MK	4
Koers losse kop	mm	120
Elektrische aansluiting		
Spanning	V	3x400
Vermogen motor	kW	5.5
Vermogen motor koelpomp	W	100
Gewicht	kg	1550,00
Afmetingen (l x b x h)	mm	2025 x 915 x 1615
Prijs	€	14.900,00

TU4210V

- Wagen:
 - Precies bewerkt
 - Handwielen instelbaar met fijn afstelling 0,04/0,02mm
 - Alle geleidingen nastelbaar met spiëen

- Kwaliteit klauwplaat:
 - precies, hoger toerentalbereik

- Digitale aflezing DPA2000S op 3 assen

- 2 traps snelheid-schakeling laag/hog

- Spilboring Ø52 mm

- Hoofdspindel:
 - Gehard en geslepen
 - In een oliebad
 - Met 2 instelbare precisie kegellagers
 - Hoogwaardige GATES aandrijfriem

- SWH 40 posities snelwissel beitelhouder

- Grote beitelafscherming

- Tegenpunt MK4 +/- 13mm verstelbaar

NEW VARIO

1000 mm

52mm

210 mm

ACCESSOIRES

p.1012-1091

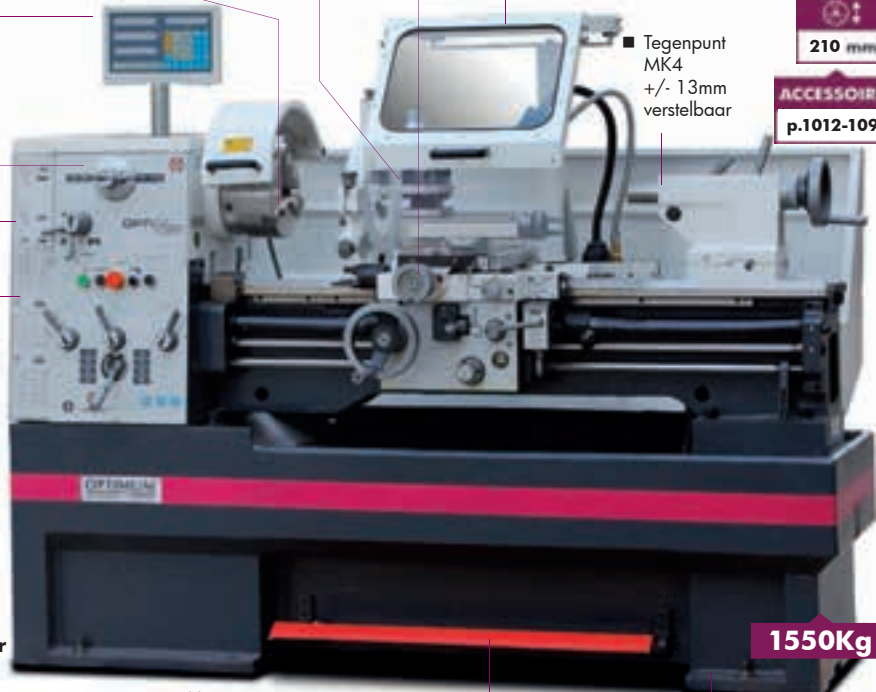

Frequentieomvormer Sinamics G120D



Powered by Siemens

1550Kg

- Voetrem

- Gietijzeren machieneonderstel

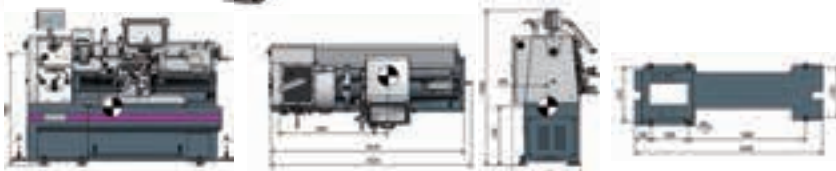

Standaard geleverd met :

- Zelfcentrerende klauwplaat met 3 klauwen ø 200 mm rechtstreekse koppeling directe montage (zonder gebruik van flens)
- Onafhankelijke vierbekken plaat ø 250 mm rechtstreekse koppeling directe montage (zonder gebruik van flens)
- Vlakplaat ø 350 mm
- Reductiehuls MK6 – MK4
- 2 Vaste centers MK4
- Vaste bril met doorlaat van maximum 145 mm
- Volg bril met doorlaat van maximum 75 mm
- Spatwand (gemonteerd)
- Klauwplaat- en beitel afscherming
- 40 positie snelwissel beitelhouder met 1 vierkante

- beitelhouder
- Koelvloeistofsysteem
- Draadsnijblok
- Halogeen machineverlichting
- Wisselwielen set
- Eerste vulling met hoogwaardige Mobil olie – vaste kop – Mobilgear 627, transmissie Mobilgear 629.
- Bedieningsleutels
- Afnameprotocol
- Nederlandstalige handleiding, opschriften, CE kenmerk, en CE-attest volgens Machine richtlijn 2006/42/CE, Laagspanningsrichtlijn 2006/95/CE en EMC Richtlijn 2004/108/CE. Montage en ingebruikname machine zijn niet inbegrepen.

**OPTI**

Compleet uitgeruste, zware lei- en voedingsas draaibank.

- Camlock spilneus ASA D1-6" volgens DIN55029
- Gegarandeerde rondloop nauwkeurigheid van de spilneus beter dan 0,015 mm
- Alle geleidingen door spieën na stelbaar.
- Uitneembaar bedbrug voor het draaien van grotere diameters.
- In een oliebad lopende hoofdspindel, gehard en geslepen met twee afstelbare precisie kogellagers. Geharde en geslepen tandwielen en assen, precisielopend in een oliebad.
- Bovenslede is onder +/-90° verstelbaar.
- Uit één stuk gegoten Meehaniet gietijzeren machineonderstel en machinebed
- **Digitale uitlezing DPA2000 op 3 assen gemonteerd.**
- **Snelwisselende beitelhoeder SWH5 – B met 1 vierkantshouder**
- Keuzeschakelaar rechts – linksdraaiend, aparte noodstop en aparte start/stopknop
- Voor vlakdraaien, langsdraaien, kegeldraaien en draadsnijden.
- Sterk geribd prismabed van gietstaal (GG30), inductie gehard en fijn geslepen.
- Klauwplaat afscherming met microscharnelaar, degelijke beitel afscherming, leispilafscherming en mooie spatwand. Mechanische noodstop – voetrem.
- Gesloten koelvloeistofsysteem met aparte koelpomp
- Losse kop kan +- 15 mm verschoven worden voor het draaien van kegels.
- Door een wisselwiel set een groot bereik bij het draadsnijden.
- Met een voedingsas voor draadsnijden of het automatisch langsdraaien.
- Krachtige, onderhoudsvrije motor 5,5 kW.

Order nr.	713402109 ^M	713402159 ^M	713402209 ^M
Orig. nr.	D460X1000 DPA SWH	D460X1500 DPA SWH	D460X2000 DPA SWH
Capaciteit			
Centerhoogte	mm 230	230	230
Centerafstand	mm 1000	1500	2000
Draaidiameter boven bed	mm 465	465	465
Draaidiameter boven slede	mm 270	270	270
Draaidiameter zonder bedbrug	mm 690	690	690
Draailengte in de bedbrug	mm 240	240	240
Bedbreedte	mm 300	300	300
Kop			
Aantal snelheden	12	12	12
Spindeltoerental	min-1 25-2000	25-2000	25-2000
Spilkonus	MK 6	6	6
Spilneus Camlock DIN55029	D1-6"	D1-6"	
Spilboring	mm 58	58	58
Draadstappen en voeding			
Langsvoeding	mm/O 0,031-1,7 (42)	0,031-1,7 (42)	0,031-1,7 (42)
Dwarsvoeding	mm/O 0,014-0,784 (42)	0,014-0,784 (42)	0,014-0,784 (42)
Draadsnijden metrisch	M 0,1-1,4 (53)	0,1-1,4 (53)	0,1-1,4 (53)
Draadsnijden duim	Gg/1" 1122 (40)	1122 (40)	1122 (40)
Trapeziumdraad	D.P. 4-112 (50)	4-112 (50)	4-112 (50)
Modulaire draad	M.P. 0,1-7 (34)	0,1-7 (34)	0,1-7 (34)
Geleiding en wagen			
Rijweg beitel slede	mm 128	128	128
Rijweg dwars slede	mm 285	285	285
Hoogte beitelhouder	mm 25	25	25
Losse kop			
Konus losse kop	MK 4	4	4
Koers losse kop	mm 130	130	130
Elektrische aansluiting			
Spanning	V 3x400	3x400	3x400
Vermogen motor	kW 5,8	5,8	5,8
Vermogen motor koelpomp	W 100	100	100
Gewicht	kg 1720,00	2750,00	3250,00
Afmetingen (l x b x h)	mm 2200 x 1245 x 1568	2750 x 1245 x 1568	3250 x 1245 x 1568
Prijs	€ 13.190,00	14.590,00	15.490,00

D460x1000/x1500/x2000

- Afzonderlijke koelbak



- SWH 40 posities snelwissel beitelhouder

- Draadsnij klok

- Koelvloeistofsysteem met koelpomp & tank

- 12 snelheden van 25/2000 tpm

- Camlock spindel

- DPA digitale aflezing op 3 assen

- Tegenpunt MK4 spil

- Spilboring \varnothing 58 mm
- Complete tandwielkast voor draadsnijden

- Mechanie gietijzeren onderstel uit één stuk gegoten

- Voetrem

- Keuzehendel links/rechts draaien

- 4 positie lengte aanslag

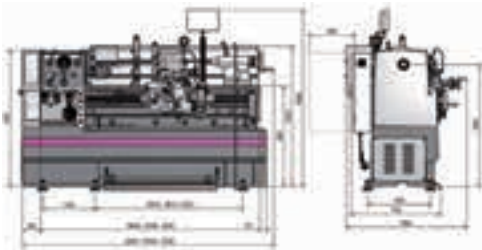

NEW VARIO

1000/1500/2000mm

\varnothing 58mm

220 mm

ACCESSOIRES

p.1012-1091

Standaard geleverd met :

- Digitale uitlezing DPA2000 op 3 assen gemonteerd
- Snelwisselende beitelhouder SWH5 – B met 1 vierkantshouder
- Gesloten koelvloeistofsysteem met koelpomp
- Zelfcenterende klauwplaat met 3 klauwen \varnothing 250 mm rechtstreekse koppeling directe montage (zonder gebruik van flens)
- Onafhankelijke vierbekken plaat \varnothing 300 mm rechtstreekse koppeling directe montage (zonder gebruik van flens)
- Vlakplaat \varnothing 350 mm
- Reductiehuls MK6-MK4
- 2 Vaste centers MK4
- Vaste bril met doorlaat van maximum 160 mm
- Volg bril met doorlaat van maximum 100 mm

- Gietijzeren onderstel en bed uit één stuk - Klauwplaat en beitel afscherming, spatwand en spanenbak
- Mechanische voetrem pedaal
- Draadsnij klok
- Halogeen machineverlichting
- Wisselwielen set
- Eerste vulling met hoogwaardige Mobil olie – vaste kop – Mobilgear 627, transmissie Mobilgear 629.
- Bedieningsleutels
- Afnameprotocol
- Nederlandstalige handleiding, opschriften, CE kenmerk, en CE-attest volgens Machine richtlijn 2006/42/CE, Laagspanningsrichtlijn 2006/95/CE en EMC Richtlijn 2004/108/CE. Montage en ingebruikname machine zijn niet inbegrepen.



Compleet uitgeruste precisie lei- en voedingsas draaibank met **Siemens inverter** vario aandrijving en digitale positieaanduiding DPA2000S op 3 assen.

Argumenten, die in kwaliteit, prestatie en prijs overtuigen:

- Geharde en geslepen prismabed geleidingen
- **Hoogwaardig gietijzeren onderstel.**
- Spindelopname Camlock DIN ISO 702:2 Nr. 8
- **Doorlaat ø 80 mm**
- Toerentalbewaking volgens de machinerichtlijn. EMV filter klasse 2 voor de inzet in verschillende gebieden
- Gegarandeerde rondloop nauwkeurigheid van de spilneus beter dan 0,015 mm
- Alle metrische en inch draadsnij mogelijkheden in bereik van 0,1 tot 14 mm/omw. en van 112 tot 2 gangen per inch, kunnen gesneden worden **zonder het omwisselen van tandwielen** door middel van de schakelhendels.
- Tandwielen en assen zijn gehard en geslepen, lopend in een oliebad met precisie lagers
- Aparte noodstop, motorbeveiliging en vergrendelbare hoofdschakelaar. Rechts / links lopend door middel van hendel aan de wagen
- Centraal smeersysteem voor het bed. Halogeen machineverlichting
- **40 positie snelwissel beitelhoeder met 1 beitelhoeder voor vierkante beitels.**
- De elektrische routing loopt in een kabelgoot, dus geen loshangende kabels in de koelvloeistof, alsook een mooie geleidingen van de elektrische kabels van de wagen. Elektrische uitrusting met Siemens componenten
- Sterk geribd prismabed uit grijsgietijzer, inductie gehard en precisie geslepen
- Geharde spilneus en gelagerd in na stelbare kegelkogellagers klasse P5 kwaliteit.
- Klauwplaat afscherming met microsckelaar. Degelijke beitel afscherming op de wagen gemonteerd en mooie spatwand. Leispilafscherming rond de leispindel.
- Voorzien van druklager op de dwars (voor het opnemen van axiale krachten)
- Leispindel in twee sinterlagers (glijlagers met olie, die geen smering meer vereisen)
- 2 traps elektronisch regelbare spilsnelheden 30 - 400 / 160 - 2000 min⁻¹ .
- **Digitale aflezing DPA2000S over 3 glaslinialen** met digitale weergave van de spilsnelheden: Duidelijke vermindering van de insteltijden, Hogere arbeidsnauwkeurigheid, Foutenmarge wordt gereduceerd, Digitale weergave van de spilsnelheden
- Losse kop kan +/- 15 mm verplaatst worden voor het draaien van kegels, met snelklemming van de losse kop voor een nog betere klemming
- Uiterst krachtige, onderhoudsvrije motor van 8,5 kW.

Order nr.		713403170
Orig. nr.		TU4615V
Capaciteit		
Centerhoogte	mm	230
Centerafstand	mm	1500
Draaidiameter boven bed	mm	465
Draaidiameter boven slede	mm	270
Draaidiameter zonder bedbrug	mm	690
Draailengte in de bedbrug	mm	240
Bedbreedte	mm	300
Kop		
Aantal snelheden		traploos (2 traps)
Spindeltoerental	min-1	30-400 / 160-2000
Spilkonus	MK	7
Spilneus Camlock DIN55029		D1-8"
Spilboring	mm	80
Draadstappen en voeding		
Langsvoeding	mm/O	0.031-1.7
Dwarsvoeding	mm/O	0.014-0.784
Draadsnijden metrisch	M	0.1-14
Draadsnijden duim	Gg/1"	1122
Trapeziumdraad	D.P.	4-112
Modulaire draad	M.P.	0.1-7
Geleiding en wagen		
Rijweg beitelslede	mm	128
Rijweg dwarslede	mm	285
Hoogte beitelhoeder	mm	25x25
Losse kop		
Konus losse kop	MK	4
Koers losse kop	mm	130
Elektrische aansluiting		
Spanning	V	3x400
Vermogen motor	kW	8.5
Vermogen motor koelpomp	W	100
Gewicht	kg	1980,00
Afmetingen (l x b x h)	mm	2200 x 1245 x 1568
Prijs	€	19.900,00

TU4615V

NEW VARIO

1500 mm

80 mm

230 mm

ACCESSOIRES
p.1012-1091

- Hoofdspindel:
 - Gehard en geslepen
 - In een oliebad
 - Met 2 instelbare precisie kegellagers
 - Hoogwaardige GATES aandrijfriemen

- Digitale aflezing DPA2000S op 3 assen
- 2 traps snelheid-schakeling laag/hog

- Kwaliteit klauwplaat: precies, hoger toerentalbereik
- Grote beitelaafscherming

- 40 positie snelwisselhouder
- Tegenpunt MK4 +/- 15mm verstelbaar

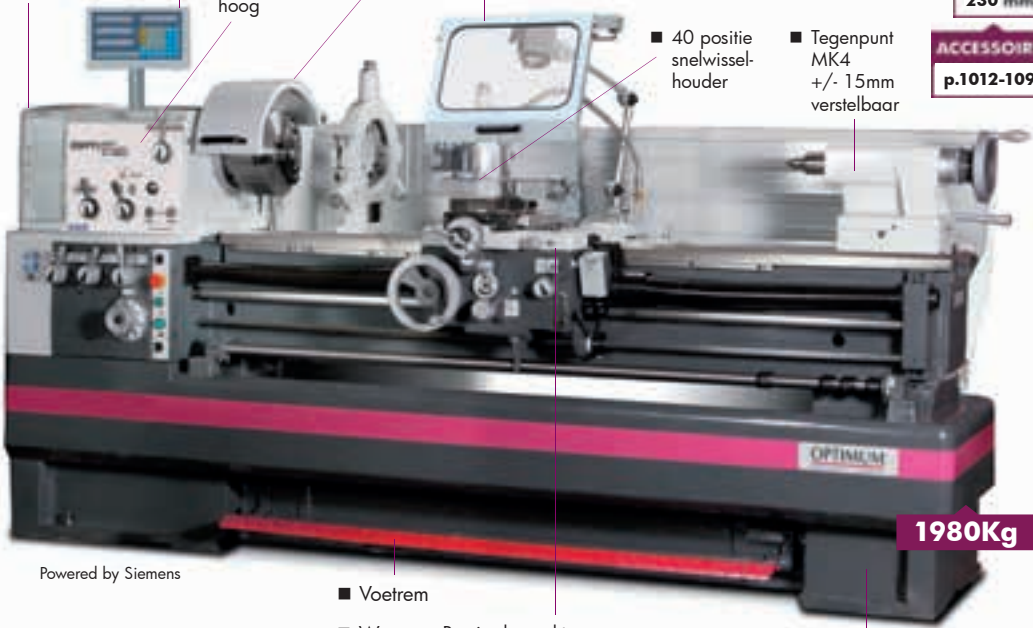

Powered by Siemens

1980Kg

- Voetrem
- Wagen:
 - Precies bewerkt
 - Handwielen instelbaar met fijnafstelling 0,04/0,02mm
 - Alle geleidingen nastelbaar met spiëen

- Gietijzeren machineonderstel

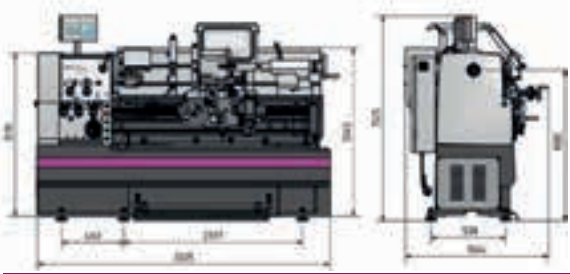

Frequentieomvormer Sinamics G120D



Standaard geleverd met :

- Zelfcentrerende klauwplaat met 3 klauwen ø 250 mm rechtstreekse koppeling directe montage (zonder gebruik van flens)
- Onafhankelijke vierbekken plaat ø 300 mm rechtstreekse koppeling directe montage (zonder gebruik van flens)
- Vlakplaat ø 350 mm
- Reductiehuls MK7 - MK4
- 2 Vaste centers MK4
- Vaste bril met doorlaat van maximum 160 mm
- Volg bril met doorlaat van maximum 100 mm
- Spatwand (gemonteerd)
- Klauwplaat- en beitel afscherming
- 40 positie snelwissel beitelhouder met 1 vierkante beitelhouder

- Koelvloeistofsysteem
- Draadsnijblok
- Halogeen machineverlichting
- Wisselwielen set
- Eerste vulling met hoogwaardige Mobil olie – vaste kop – Mobilgear 627, transmissie Mobilgear 629.
- Bedieningsleutels
- Afnameprotocol
- Nederlandstalige handleiding, opschriften, CE kenmerk, en CE-attest volgens Machine richtlijn 2006/42/CE, Laagspanningsrichtlijn 2006/95/CE en EMC Richtlijn 2004/108/CE

Montage en ingebruikname machine zijn niet inbegrepen.



Compleet uitgeruste, zware lei- en voedingsas draaibank, die zich kenmerken door hoge flexibiliteit, precisie en efficiëntie.

- Camlock spilneus ASA D1-8" volgens DIN55029 met **grote doorlaat ø 80 mm**
- Gegarandeerde rondloop nauwkeurigheid van de spilneus beter dan 0,015 mm
- Alle geleidingen door spieën na stelbaar.
- Uitneembaar bedbrug voor het draaien van grotere diameters.
- In een oliebad lopende hoofdspindel, gehard en geslepen met twee afstelbare precisie kogellagers. Geharde en geslepen tandwielen en assen, precisielopend in een oliebad.
- Alle metrische draadstappen van 0,2 tot 14 mm/omw en alle Withworth draadstappen van 112 – 2 Gg/1"
- Bovenslede is onder +/-90° verstelbaar.
- Uit één stuk gegoten Meehaniet gietijzeren machineonderstel en machinebed
- **Digitale uitlezing DPA2000 op 3 assen gemonteerd.**
- **Snelwisselende beitelhoeder SWH7 – C met 1 vierkantshouder**
- Keuzeschakelaar rechts – linksdraaiend. Aparte noodstop en aparte start/stopknop
- Voor vlakdraaien, langsdraaien, kegeldraaien en draadsnijden.
- Sterk geribd prismabed van gietstaal (GG30), inductie gehard en fijn geslepen.
- Klauwplaat afscherming met microscharnelaar, degelijke beitel afscherming, leispilafscherming en mooie spatwand. Mechanische noodstop – voetrem.
- Gesloten koelvloeistofsysteem met aparte koelpomp
- Losse kop kan +/- 15 mm verschoven worden voor het draaien van kegels.
- Door een wisselwielen set een groot bereik bij het draadsnijden.
- Krachtige, onderhoudsvrije motor 7,5 kW.

Order nr.	713402619 ^M	713402629 ^M	713402639 ^M
Orig. nr.	D560X1500 DPA SHW	D560X2000 DPA SWH	D560X3000 DPA SWH
Capaciteit			
Centerhoogte	mm	280	280
Centerafstand	mm	1500	2000
Draaidiameter boven bed	mm	560	560
Draaidiameter boven slede	mm	355	355
Draaidiameter zonder bedbrug	mm	790	790
Draailengte in de bedbrug	mm	270	270
Bedbreedte	mm	350	350
Kop			
Aantal snelheden		12	12
Spindeltoerental	min-1	25-1600	25-1600
Spilkonus	MK	7	7
Spilneus Camlock DIN55029		D1-8"	D1-8"
Spilboring	mm	80	80
Draadstappen en voeding			
Langsvoeding	mm/O	0,059-1,646 (35)	0,059-1,646 (35)
Dwarsvoeding	mm/O	0,020-0,573 (35)	0,020-0,573 (35)
Draadsnijden metrisch	M	0,2-14 (47)	0,2-14 (47)
Draadsnijden duim	Gg/1"	1122 (60)	1122 (60)
Trapeziumdraad	D.P.	4-112 (50)	4-112 (50)
Modulaire draad	M.P.	0,1-7 (34)	0,1-7 (34)
Geleiding en wagen			
Rijweg beitelslede	mm	130	130
Rijweg dwarslede	mm	316	316
Hoogte beitelhouder	mm	25	25
Losse kop			
Konus losse kop	MK	5	5
Koers losse kop	mm	180	180
Elektrische aansluiting			
Spanning	V	3x400	3x400
Vermogen motor	kW	8,5	8,5
Vermogen motor koelpomp	W	100	100
Gewicht	kg	2302,00	2720,00
Afmetingen (l x b x h)	mm	2840 x 1150 x 1460	3340 x 1150 x 1460
Prijs	€	16.990,00	18.890,00
			21.990,00

D560x1500/2000/3000

- Afzonderlijke koelbak



- SWH 40 posities snelwissel beitelhouder

- Koelvloeistofsysteem met koelpomp & tank

- DPA digitale aflezing op 3 assen gemonteerd

- Gesloten koelvloeistofsysteem met koelpomp & tank

- Draadsnijblok

- Prismabed inductiegehard & geslepen

- Camlock spindel

- 12 snelheden van 25/1600 tpm

- Voorzien van bedbrug

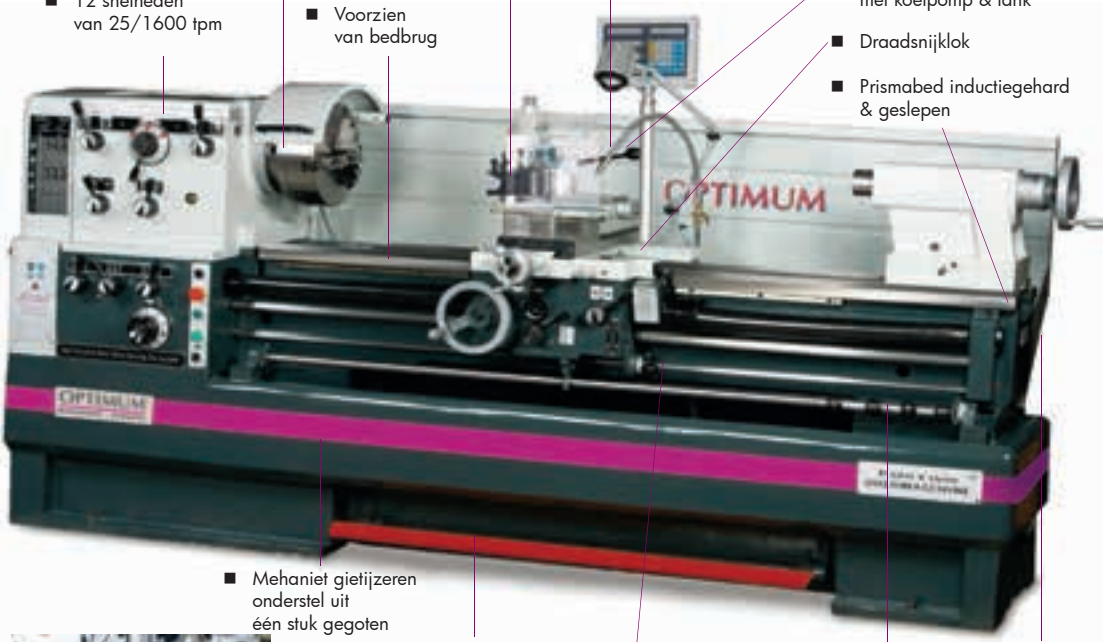

- Mehaniet gietijzeren onderstel uit één stuk gegoten

- Voetrem

- Keuzehendel links/rechts draaien

- 4 positie lengte aanslag

- Zwaar geribd



Standaard geleverd met :

- Digitale uitlezing DPA2000 op 3 assen gemonteerd
- Snelwisselende beitelhouder SWH7 - C met 1 vierkantshouder
- Gesloten koelvloeistofsysteem met koelpomp
- Zelfcentrerende klauwplaat met 3 klauwen \varnothing 315 mm rechtstreekse koppeling directe montage (zonder gebruik van flens)
- Onafhankelijke vierbekken plaat \varnothing 400 mm rechtstreekse koppeling directe montage (zonder gebruik van flens)
- Vlakplaat \varnothing 450 mm
- Reductiehuls MK7-MK5 - 2 Vaste centers MK5
- Vaste bril met doorlaat van maximum 165 mm
- Volg bril met doorlaat van maximum 95 mm
- Gietijzeren onderstel en bed uit één stuk

- Klauwplaat- en beitel afscherming, spatwand en spanenbak
- Mechanische voetrem pedaal
- Draadsnijblok
- Halogeen machineverlichting
- Wisselwielen set
- Eerste vulling met hoogwaardige Mobil olie – vaste kop – Mobilgear 627, transmissie Mobilgear 629.
- Bedieningsleutels
- Afnameprotocol
- Nederlandstalige handleiding, opschriften, CE kenmerk, en CE-attest volgens Machine richtlijn 2006/42/CE, Laagspanningsrichtlijn 2006/95/CE en EMC Richtlijn 2004/108/CE. Montage en ingebruikname machine zijn niet inbegrepen.

OPTI

Compleet uitgeruste precisie lei- en voedingsas draaibank met **Siemens inverter** vario aandrijving en digitale positieaanduiding DPA2000S op 3 assen.

Argumenten, die in kwaliteit, prestatie en prijs overtuigen:

- Geharde en geslepen prismabed geleidingen
- **Hoogwaardig gietijzeren onderstel.**
- Spindelopname Camlock DIN ISO 702:2 Nr. 8
- **Doorlaat ø 105 mm**
- Hoge en precieze afwerkinggraad, toerentalbewaking volgens de machinerichtlijn
- EMV filter klasse 2 voor de inzet in verschillende gebieden
- Gegarandeerde rondloop nauwkeurigheid van de spilneus beter dan 0,015 mm
- Alle metrische en inch draadsnij mogelijkheden in bereik van 0,2 tot 14 mm/omw. en van 112 tot 2 gangen per inch, kunnen gesneden worden **zonder het omwisselen van tandwielen** door middel van de schakelhendels.
- Tandwielen en assen zijn gehard en geslepen, lopend in een oliebad met precisie lagers
- Aparte noodstop, motorbeveiliging en vergrendelbare hoofdschakelaar
- Rechts / links lopend door middel van hendel aan de wagen
- Centraal smeersysteem voor het bed.
- **40 positie snelwissel beitelhoeder met 1 beitelhoeder voor vierkante beitels.**
- Halogeen machineverlichting
- Nieuwe plaatstalen machine onderstel met 3 aparte lades en opbergvak
- Groot gedimensioneerde spatwand
- De elektrische routing loopt in een kabelgoot, dus geen loshangende kabels in de koelvloeistof, alsook een mooie geleidingen van de elektrische kabels van de wagen
- Voetrem
- Elektrische uitrusting met Siemens componenten
- Instelbare maatschaal van de draadsnij klok
- Sterk geribd prismabed uit grijsgietijzer, inductie gehard en precisie geslepen
- Geharde spilneus en gelagerd in na stelbare kegelkogellagers klasse P5 kwaliteit.
- Met leispil voor het draad snijden of automatisch langs draaien en met langs, dwars, en kleine slede
- Klauwplaat afscherming met microschaakelaar
- Degelijke beitel afscherming op de wagen gemonteerd en mooie spatwand
- Leispilafscherming rond de leispindel.
- Voorzien van druklager op de dwars (voor het opnemen van axiale krachten)
- Leispindel in twee sinterlagers (glijlagers met olie, die geen smering meer vereisen)
- Door een wisselwiel set een groot bereik bij het draad snijden.
- 2 traps elektronisch regelbare spilsnelheden 25 - 200 / 200 - 1600 min-1 .

Order nr.	713403210 	
Orig. nr.	TU5620V	
Capaciteit		
Centerhoogte	mm	280
Centerafstand	mm	2000
Draaidiameter boven bed	mm	560
Draaidiameter boven slede	mm	355
Draaidiameter zonder bedbrug	mm	785
Draailengte in de bedbrug	mm	170
Bedbreedte	mm	350
Kop		
Aantal snelheden		traploos (2 traps)
Spindeltoerental	min-1	25-200 / 200-1600
Spilkonus	MK	7
Spilneus Camlock DIN55029		D1-8"
Spilboring	mm	105
Draadstappen en voeding		
Langsvoeding	mm/O	0.059-1.646
Dwarsvoeding	mm/O	0.020-0.573
Draadsnijden metrisch	M	0.2-14
Draadsnijden duim	Gg/1"	1122
Trapeziumdraad	D.P.	4-112
Modulaire draad	M.P.	0.1-7
Geleiding en wagen		
Rijweg beitelslede	mm	130
Rijweg dwarslede	mm	316
Hoogte beitelhouder	mm	25x25
Losse kop		
Konus losse kop	MK	5
Koers losse kop	mm	180
Elektrische aansluiting		
Spanning	V	3x400
Vermogen motor	kW	8.5
Vermogen motor koelpomp	W	100
Gewicht	kg	2985,00
Afmetingen (l x b x h)	mm	3340 x 1150 x 1460
Prijs	€	23.900,00

TU5620V

NEW VARIO

2000 mm

ø105mm

280 mm

ACCESSOIRES

p.1012-1091

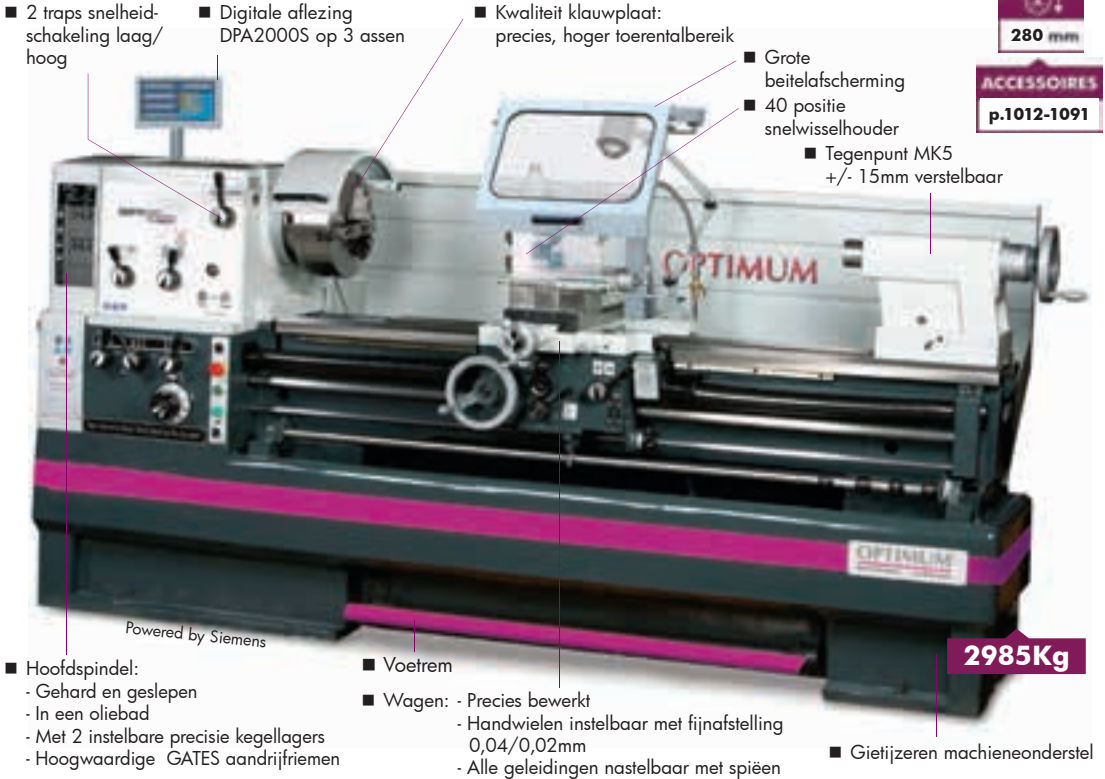

- 2 traps snelheid-schakeling laag/hog
- Digitale aflezing DPA2000S op 3 assen
- Kwaliteit klauwplaat: precies, hoger toerentalbereik
- Grote beitelaafscherming
- 40 positie snelwisselhouder
- Tegenpunt MK5 +/- 15mm verstelbaar
- Hoofdspindel:
 - Gehard en geslepen
 - In een oliebad
 - Met 2 instelbare precisie kegellagers
 - Hoogwaardige GATES aandrijfriemen
- Voetrem
- Wagen:
 - Precies bewerkt
 - Handwielen instelbaar met fijnafstelling 0,04/0,02mm
 - Alle geleidingen nastelbaar met spieën
- Gietijzeren machineonderstel

Powered by Siemens

2985Kg

Frequentieomvormer Sinamics G120D



Standaard geleverd met :

- Zelfcenterende klauwplaat met 3 klauwen ø 315 mm rechtstreekse koppeling directe montage (zonder gebruik van flens)
- Onafhankelijke vierbekken plaat ø 350 mm rechtstreekse koppeling directe montage (zonder gebruik van flens)
- Vlakplaat ø 450 mm
- Reductiehuls MK7 – MK5
- 2 Vaste centers MK5
- Vaste bril met doorlaat van maximum 165 mm
- Volg bril met doorlaat van maximum 95 mm
- Spatwand (gemonteerd)
- Klauwplaat- en beitel afscherming
- 40 positie snelwissel beitelhouder met 1 vierkante

- beitelhouder
- Koelvloeistofsysteem
- Draadsnijblok
- Halogeen machineverlichting
- Wisselwielen set
- Eerste vulling met hoogwaardige Mobil olie – vaste kop – Mobilgear 627, transmissie Mobilgear 629.
- Bedieningsleutels
- Afnameprotocol
- Nederlandstalige handleiding, opschriften, CE kenmerk, en CE-attest volgens Machine richtlijn 2006/42/CE, Laagspanningsrichtlijn 2006/95/CE en EMC Richtlijn 2004/108/CE
- Montage en ingebruikname machine zijn niet inbegrepen.



Compleet uitgeruste, zware lei- en voedingsas draaibank, met veelvuldige schijfkoppeling en grote doorlaat ø105 mm.

- Camlock spilneus ASA D1-8" volgens DIN55029 **met grote doorlaat ø 105 mm**
- Mechanische veelvuldige koppeling voor het kiezen van draairichting zonder de motor te laten afslaan.
- Alle geleidingen door spieën na stelbaar.
- Uitneembaar bedbrug voor het draaien van grotere diameters.
- In een oliebad lopende hoofdspindel, gehard en geslepen met drie afstelbare precisie kogellagers. Geharde en geslepen tandwielen en assen, precisielopend in een oliebad.
- Ijlgang op de langs en dwarsverplaatsing van de wagen door middel van joystick met activatieknop
- Bovenslede is onder 360° verstelbaar.
- Uit één stuk gegoten Meehaniet gietijzeren machineonderstel en machinebed
- Hoge en precieze afwerkingsgraad
- **Digitale uitlezing DPA2000 op 3 assen gemonteerd.**
- **Snelwisselende beitelhoeder SWH9 - D met 1 vierkantshouder**
- Keuzeschakelaar rechts - linksdraaiend. Aparte noodstop en aparte start/stopknop
- Voor vlakdraaien, langsdraaien, kegeldraaien en draadsnijden.
- Sterk geribd prismabed van gietstaal (GG30), inductie gehard en fijn geslepen.
- Klauwplaat afscherming met microschakelaar, degelijke beitel afscherming, leispilafscherming en mooie spatwand. Mechanische noodstop - voetrem.
- Gesloten koelvoelstofsysteem met aparte koelpomp en afzonderlijke tank.
- Losse kop kan +- 13 mm verschoven worden voor het draaien van kegels.
- Krachtige, onderhoudsvrije motor 7,5 kW.

Order nr.		713402720 ^M	713402730 ^M
Orig. nr.		D660X2000 DPA SHW	D660X3000 DPA SHW
Capaciteit			
Centerhoogte	mm	330	330
Centerafstand	mm	2000	3000
Draaidiameter boven bed	mm	660	660
Draaidiameter boven slede	mm	440	440
Draaidiameter zonder bedbrug	mm	900	900
Draailengte in de bedbrug	mm	250	250
Bedbreedte	mm	400	400
Kop			
Aantal snelheden		16	16
Spindeltoerental	min-1	25-1600	25-1600
Spilkonus	MK	7	7
Spilneus Camlock DIN55029		D1-8"	D1-8"
Spilboring	mm	105	105
Draadstappen en voeding			
Langsvoeding	mm/O	0,044-1,48 (25)	0,044-1,48 (25)
Dwarsvoeding	mm/O	0,022-0,74 (25)	0,022-0,74 (25)
Draadsnijden metrisch	M	0,45-120 (54)	0,45-120 (54)
Draadsnijden duim	Gg/1"	80-7/16 (60)	80-7/16 (60)
Trapeziumdraad	D.P.	7/8-160 (42)	7/8-160 (42)
Modulaire draad	M.P.	0,25-60 (46)	0,25-60 (46)
Geleiding en wagen			
Rijweg beitelslede	mm	230	230
Rijweg dwarslede	mm	368	368
Hoogte beitelhouder	mm	32	32
Losse kop			
Konus losse kop	MK	5	5
Koers losse kop	mm	235	235
Elektrische aansluiting			
Spanning	V	3x400	3x400
Vermogen motor	kW	9	9
Vermogen motor koelpomp	W	100	100
Gewicht	kg	3345,00	3710,00
Afmetingen (l x b x h)	mm	3650 x 1230 x 1595	4650 x 1230 x 1595
Prijs	€	25.750,00	28.500,00

D660x2000/3000

- Afzonderlijke koelbak



- SWH 40 posities
snelwissel
beitelhouder

- Klauwplaatscherming
met microscharakelaar

- Elektrische
motorrem

- Machineverlichting

- DPA digitale
aflezing op 3
assen gemonteerd

- Tegenpunt met 2
snelheden

ACCESSOIRES
p.1012-1091

2000/
3000mm

ø105mm

330 mm

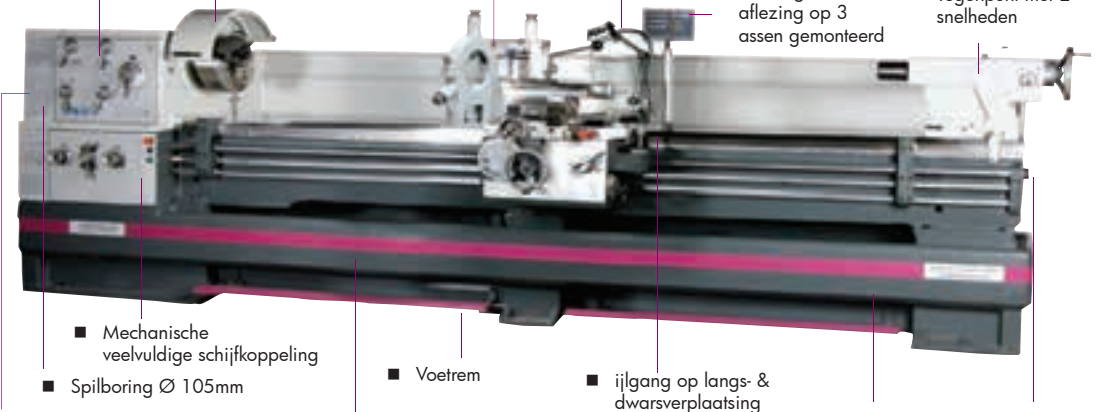

- Mechanische
veelvuldige schijfkoppeling

- Spilboring Ø 105mm

- Voetrem

- iJlgang op langs- &
dwarsverplaatsing

- Volledige nortonkast

- Kabels in kabelgoot



- Mechaniek
gietijzeren
onderstel uit
één stuk gegoten

- Sterk geribd
prismabed

Standaard geleverd met :

- Digitale uitlezing DPA2000 op 3 assen gemonteerd
- Snelwisselende beitelhoeder SWH9 – D met 1 vierkantshouder
- Gesloten koelvoelstofsysteem met koelpomp en afzonderlijke tank
- Zelfcentrerende klauwplaat met 3 klauwen ø 315 mm rechtstreekse koppeling directe montage (zonder gebruik van flens)
- Onafhankelijke vierbekken plaat ø 400 mm rechtstreekse koppeling directe montage (zonder gebruik van flens)
- Vlakplaat ø 450 mm
- Reductiehuls MK7-MK5
- 2 Vaste centers MK5
- Vaste bril met doorlaat van maximum 150 mm
- Volg bril met doorlaat van maximum 80 mm

- Gietijzeren onderstel en bed uit één stuk
- Klauwplaat- en beitelscherming, spatwand en spanbak
- Mechanische voetrem pedaal
- Draadsnijblok
- Halogeen machineverlichting
- Wisselwielen set
- Eerste vulling met hoogwaardige Mobil olie – vaste kop – Mobilgear 627, transmissie Mobilgear 629.
- Bedieningsleutels
- Afnameprotocol
- Nederlandstalige handleiding, opschriften, CE
- kenmerk, en CE-attest volgens Machine richtlijn 2006/42/CE, Laagspanningsrichtlijn 2006/95/CE en EMC Richtlijn 2004/108/CE. Montage en ingebruikname machine zijn niet inbegrepen.



Compleet uitgeruste, zware lei- en voedingsas draaibank, met veelvuldige schijfkoppeling en grote doorlaat ø105 mm.

- Camlock spilneus ASA D1-8" volgens DIN55029 met **grote doorlaat ø 105 mm**
- Mechanische veelvuldige koppeling voor het kiezen van draairichting zonder de motor te laten afslaan.
- Alle geleidingen door spieën na stelbaar.
- Uitneembaar bedbrug voor het draaien van grotere diameters.
- In een oliebad lopende hoofdspindel, gehard en geslepen met drie afstelbare precisie kogellagers. Geharde en geslepen tandwielen en assen, precisielopend in een oliebad.
- **Ijlgang op de langs en dwarsverplaatsing van de wagen door middel van joystick met activatieknop**
- Bovenslede is onder 360° verstelbaar.
- Uit één stuk gegoten Meehaniet gietijzeren machineonderstel en machinebed
- **Digitale uitlezing DPA2000 op 3 assen gemonteerd.**
- **Snelwisselende beitelhoeder SWH9 – D met 1 vierkantshouder**
- Keuzeschakelaar rechts – linksdraaiend. Aparte noodstop en aparte start/stopknop
- Voor vlakdraaien, langsdraaien, kegeldraaien en draadsnijden.
- Sterk geribd prismabed van gietstaal (GG30), inductie gehard en fijn geslepen.
- Klauwplaat afscherming met microschatelaar, degelijke beitel afscherming, leispilafscherming en mooie spatwand. Mechanische noodstop – voetrem
- Gesloten koelvloeistofsysteem met aparte koelpomp en afzonderlijke tank.
- Losse kop kan +- 13 mm verschoven worden voor het draaien van kegels.
- Door een wisselwielen set een groot bereik bij het draadsnijden.
- Krachtige, onderhoudsvrije motor 7,5 kW.

Order nr.		713402782	713402783
Orig. nr.		TU8020	TU8030
Capaciteit			
Centerhoogte	mm	400	400
Centerafstand	mm	2000	3000
Draaidiameter boven bed	mm	800	800
Draaidiameter boven slede	mm	570	570
Draaidiameter zonder bedbrug	mm	1035	1035
Draailengte in de bedbrug	mm	250	250
Bedbreedte	mm	400	400
Kop			
Aantal snelheden		16	16
Spindeltoerental	min-1	25 - 1600	25 - 1600
Spilkonus	MK	7	7
Spilneus Camlock DIN55029		D1-8"	D1-8"
Spilboring	mm	105	105
Draadstappen en voeding			
Langsvoeding	mm/O	0,044-1,48 (25)	0,044-1,48 (25)
Dwarsvoeding	mm/O	0,022-0,74 (25)	0,022-0,74 (25)
Draadsnijden metrisch	M	0,45-120 (54)	0,45-120 (54)
Draadsnijden duim	Gg/1"	80-7/16 (60)	80-7/16 (54)
Trapeziumdraad	D.P.	7/8-160 (42)	7/8-160 (42)
Modulaire draad	M.P.	0,25-60 (46)	0,25-60 (46)
Geleiding en wagen			
Rijweg beitelsslede	mm	230	230
Rijweg dwarslede	mm	420	368
Hoogte beitelhouder	mm	32	32
Losse kop			
Konus losse kop	MK	5	5
Koers losse kop	mm	235	235
Elektrische aansluiting			
Spanning	V	3x400	3x400
Vermogen motor	kW	11	11
Vermogen motor koelpomp	W	100	100
Gewicht	kg	3505,00	3710,00
Afmetingen (l x b x h)	mm	3740 x 1230 x 1595	4770 x 1150 x 1850
Prijs	€	27.800,00	30.800,00

TU8020/TU8030

■ Afzonderlijke koelbak



■ SWH 40 posities snelwissel beitelhouder

■ Klauwplaatscherming met microschakelaar

■ Elektrische motorrem

■ Machineverlichting

■ DPA digitale aflezing op 3 assen gemonteerd

ACCESSOIRES
p.1012-1091

2000/
3000mm

ø105mm

400 mm

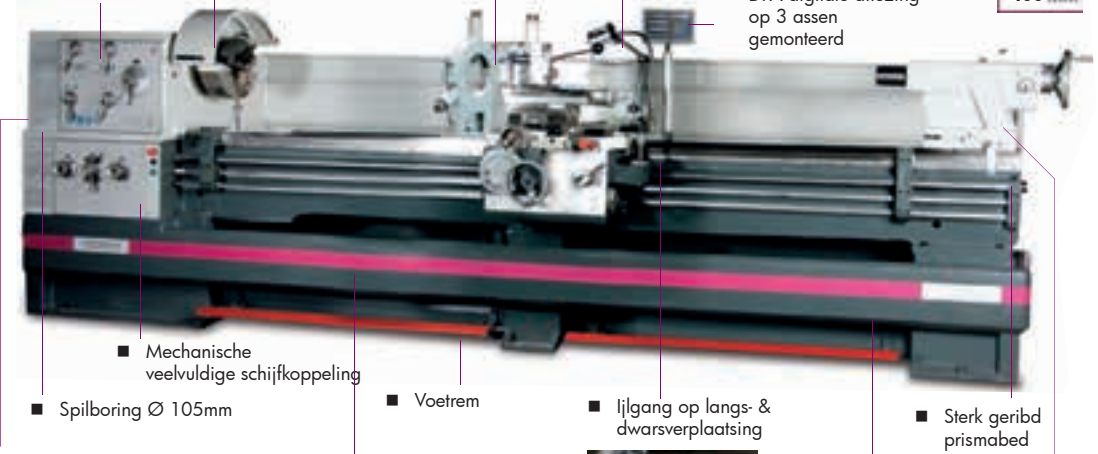

■ Mechanische veelvuldige schijfkoppeling

■ Spilboring Ø 105mm

■ Voetrem

■ Ijlgang op langs- & dwarsverplaatsing

■ Sterk geribd prismabed

■ Volledige nortonkast



■ Kabels in kabelgoot



■ Mechaniet gietijzeren onderstel uit één stuk gegoten

■ Tegenpunt met 2 snelheden

Standaard geleverd met :

- Digitale uitlezing DPA2000 op 3 assen gemonteerd
- Snelwisselende beitelhoeder SWH9 – D met 1 vierkant beitelhoeders
- Gesloten koelvloeistofstelsysteem met koelpomp en afzonderlijke tank
- Zelfcentrerende klauwplaat met 3 klauwen ø 315 mm rechtstreekse koppeling directe montage (zonder gebruik van flens)
- Onafhankelijke vierbekken plaat ø 400 mm rechtstreekse koppeling directe montage (zonder gebruik van flens)
- Vlakplaat ø 450 mm
- Reductiehuls MK7-MK5
- 2 Vaste centers MK5
- Vaste bril met doorlaat van maximum 150 mm

- Volg bril met doorlaat van maximum 80 mm
- Gietijzeren onderstel en bed uit één stuk
- Klauwplaat- en beitel afscherming, spatwand en spanenbak
- Mechanische voetrem pedaal
- Draadsnijblok
- Halogeen machineverlichting
- Wisselwielen set
- Eerste vulling met hoogwaardige Mobil olie – vaste kop – Mobilgear 627, transmissie Mobilgear 629.
- Bedieningsleutels
- Afnameprotocol
- Nederlandstalige handleiding, opschriften, CE kenmerk, en CE-attest volgens Machine richtlijn 2006/42/CE, Laagspanningsrichtlijn 2006/95/CE en EMC Richtlijn 2004/108/CE. Montage en gebruiknaam machine zijn niet inbegrepen.



OptiTurn Premium Line - precisie lei- en voedingsas draaibank.

Argumenten, die in kwaliteit, prestatie en prijs overtuigen:

- **Machinebed en onderstel uit sterk geribd speciaal Europees gietijzer.**
- Hoge vastheid van de spindelbehuizing door sterk geribd 25 GG gietijzer
- Geharde en geslepen dwarsspindel garandeert een enorme nauwkeurigheid en haalbaarheid
- Door een hoge spanenafname tijdens de schraapbewerking, kunnen de fijnste oppervlakten geproduceerd worden en de geringste toleranties verkregen worden.
- Heel groot bereik van draad snijden en voedingen, **zonder het wisselen van tandwielen in de tandwielkast**
- Geharde en geslepen precisie prismabed geleidingen
- Hoogwaardig gietijzeren onderstel.
- Perfect lopende hoofdspindel over precisie kogellagers
- Mechanische uitschakeling van langsvoeding van de bedgeleidingen over 4 instelbare excenters.
- **Elektronische rem op de hoofdspindel**
- Alle bedieningselementen (elektrisch) centraal te bereiken
- Spindelopname Camlock DIN ISO 702:2 Nr. 6
- Hoge en precieze afwerkinggraad
- Tandwielen en assen zijn gehard en geslepen, lopend in een oliebad met precisie lagers
- Aparte noodstop, motorbeveiliging en vergrendelbare hoofdschakelaar
- Centraal smeersysteem voor het bed.
- **40 positie snelwissel beitelhoeder met 1 beitelhoeder voor vierkante beitels en 1 voor ronde beitels.**
- 4 weg lengteaanslag
- Degelijke machineverlichting over het ganse bed
- Groot gedimensioneerde spatwand met glijdende beitelafscherming
- **Metalen afscherming van de leispil en moerwijs**
- Voetrem
- Klauwplaat afscherming met microscharakelaar
- Alle geleidingen door middel van spijlijsten zonder speling na stelbaar.
- **Uiterst krachtige, onderhoudsvrije motor van 4 kW.**

Order nr.		713433340
Orig. nr.		TZ4012
Capaciteit		
Centerhoogte	mm	200
Centerafstand	mm	1150
Draaidiameter boven bed	mm	400
Draaidiameter boven slede	mm	370
Draaidiameter zonder bedbrug	mm	600
Draailengte in de bedbrug	mm	160
Bedbreedte	mm	300
Kop		
Aantal snelheden		12
Spindeltoerental	min-1	40-2200
Spilkonus	MK	5
Spilneus Camlock DIN55029		D1-6"
Spilboring	mm	52
Draadstappen en voeding		
Langsvoeding	mm/O	0.05-0.75
Dwarsvoeding	mm/O	0.025-0.375
Draadsnijden metrisch	M	0.5-7.5
Draadsnijden duim	Gg/1"	60-4
Trapeziumdraad	D.P.	8-120
Modulaire draad	M.P.	0.25-3.75
Geleiding en wagen		
Rijweg beitel slede	mm	130
Rijweg dwars slede	mm	300
Hoogte beitelhouder	mm	25x25
Losse kop		
Konus losse kop	MK	4
Koers losse kop	mm	155
Elektrische aansluiting		
Spanning	V	3x400
Vermogen motor	kW	4
Vermogen motor koelpomp	W	60
Gewicht	kg	1210,00
Afmetingen (l x b x h)	mm	2380 x 995 x 1620
Prijs	€	19.590,00

PREMIUM

TZ4012

NEW VARIO

1150 mm

52mm

200 mm

ACCESSOIRES
p.1012-1091

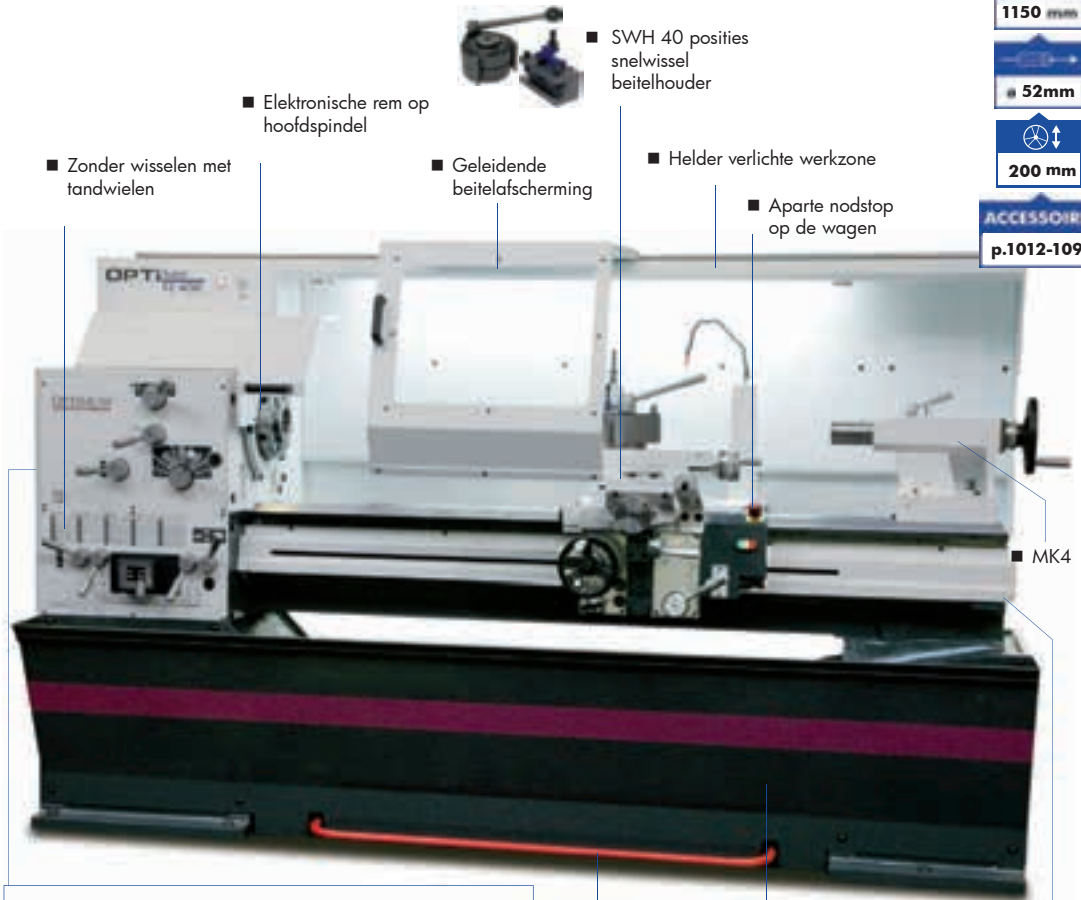

■ Elektronische rem op hoofdspindel

■ Zonder wisselen met tandwielen

■ Geleidende beitelafscherming

■ Helder verlichte werkzone

■ Aparte nodstop op de wagen

1150 mm

52mm

200 mm

ACCESSOIRES

p.1012-1091

■ MK4

■ Volledig uitgeruste tandwielkast in gietijzeren behuizing
Geen tandwielen meer wisselen

■ Voetrem

■ Gietijzeren onderstel

■ Metalen leispil afscherming



Standaard geleverd met :

- Reductiehuls MK5 – MK4
- 2 Vaste centers MK4
- Spatwand (gemonteerd)
- Klauwplaat- en beitel afscherming
- 40 positie snelwissel beitelhouder met 1 vierkante beitelhouder en 1 voor ronde beitels
- Koelvloeistofsysteem
- Draadsnijlklok
- Halogeen machineverlichting

- Bedieningsleutels
- Nederlandstalige handleiding, opschriften, CE kenmerk, en CE-attest volgens Machine richtlijn 2006/42/CE, Laagspanningsrichtlijn 2006/95/CE en EMC Richtlijn 2004/108/CE

Vergeet uw Premium klauwplaten en brillen niet bij te bestellen.

Montage en ingebruikname machine zijn niet inbegrepen.

OPTIL[®]

Precisie lei- en voedingsas draaibank.

Argumenten, die in kwaliteit, prestatie en prijs overtuigen:

- Machinebed en onderstel uit sterk geribd speciaal Europees gietijzer.
- Hoge vastheid van de spindelbehuizing door sterk geribd 25 GG gietijzer
- **Spildoortlaat 80 mm.** Geharde en geslepen dwarsspindel garandeert een enorme nauwkeurigheid en haalbaarheid
- Door een hoge spanenafname tijdens de schraapbewerking, kunnen de fijnste oppervlakten geproduceerd worden en de geringste toleranties verkregen worden.
- Heel groot bereik van draad snijden en voedingen, zonder het wisselen van tandwielen in de tandwielkast
- Geharde en geslepen precisie prismabed geleidingen
- Perfect lopende hoofdspindel over precisie kogellagers
- Mechanische uitschakeling van langvoeding van de bedgeleidingen over 4 instelbare excenters.
- **Elektronische rem op de hoofdspindel**
- Alle bedieningselementen (elektrisch) centraal te bereiken
- Spindelopname Camlock DIN ISO 702:2 Nr. 8
- Tandwielen en assen zijn gehard en geslepen, lopend in een oliebad met precisie lagers
- Aparte noodstop, motorbeveiliging en vergrendelbare hoofdschakelaar
- Centraal smeersysteem voor het bed.
- **40 positie snelwissel beitelhoeder met 1 beitelhoeder voor vierkante beitels en 1 voor ronde beitels**
- 4 weg lengteaanslag
- **Degelijke machineverlichting over het ganse bed**
- Groot gedimensioneerde spatwand met glijdende beitelfscherming. Metalen afscherming van de leispil en moervijs. Voetrem. Klauwplaat afscherming met microscharakelaar
- Alle geleidingen door middel van spijlijsten zonder speling na stelbaar.
- Uiterst krachtige, onderhoudsvrije motor van 5,5 kW.

Order nr.		713433350 
Orig. nr.		TZ5216
Capaciteit		
Centerhoogte	mm	260
Centerafstand	mm	1.625
Draaidiameter boven bed	mm	530
Draaidiameter boven slede	mm	325
Draaidiameter zonder bedbrug	mm	780
Draailengte in de bedbrug	mm	215
Bedbreedte	mm	350
Kop		
Aantal snelheden		12
Spindeltoerental	min-1	30-1500
Spilkonus	MK	5
Spilneus Camlock DIN55029		D1-6"
Spilboring	mm	80
Draadstappen en voeding		
Langvoeding	mm/O	0.05-1.5
Dwarsvoeding	mm/O	0.025-0.75
Draadsnijden metrisch	M	0.5-15
Draadsnijden duim	Gg/1"	60-2
Trapeziumdraad	D.P.	4-120
Modulaire draad	M.P.	0.25-7.5
Geleiding en wagen		
Rijweg beitelslede	mm	165
Rijweg dwarslede	mm	355
Hoogte beitelhoeder	mm	25x25
Losse kop		
Konus losse kop	MK	4
Koers losse kop	mm	180
Elektrische aansluiting		
Spanning	V	3x400
Vermogen motor	kW	5.5
Vermogen motor koelpomp	W	60
Gewicht	kg	1795,00
Afmetingen (l x b x h)	mm	2980 x 1060 x 1730
Prijs	€	27.590,00

PREMIUM

TZ5216

NEW

1625 mm

80mm

260 mm

ACCESSOIRES
p.1012-1091

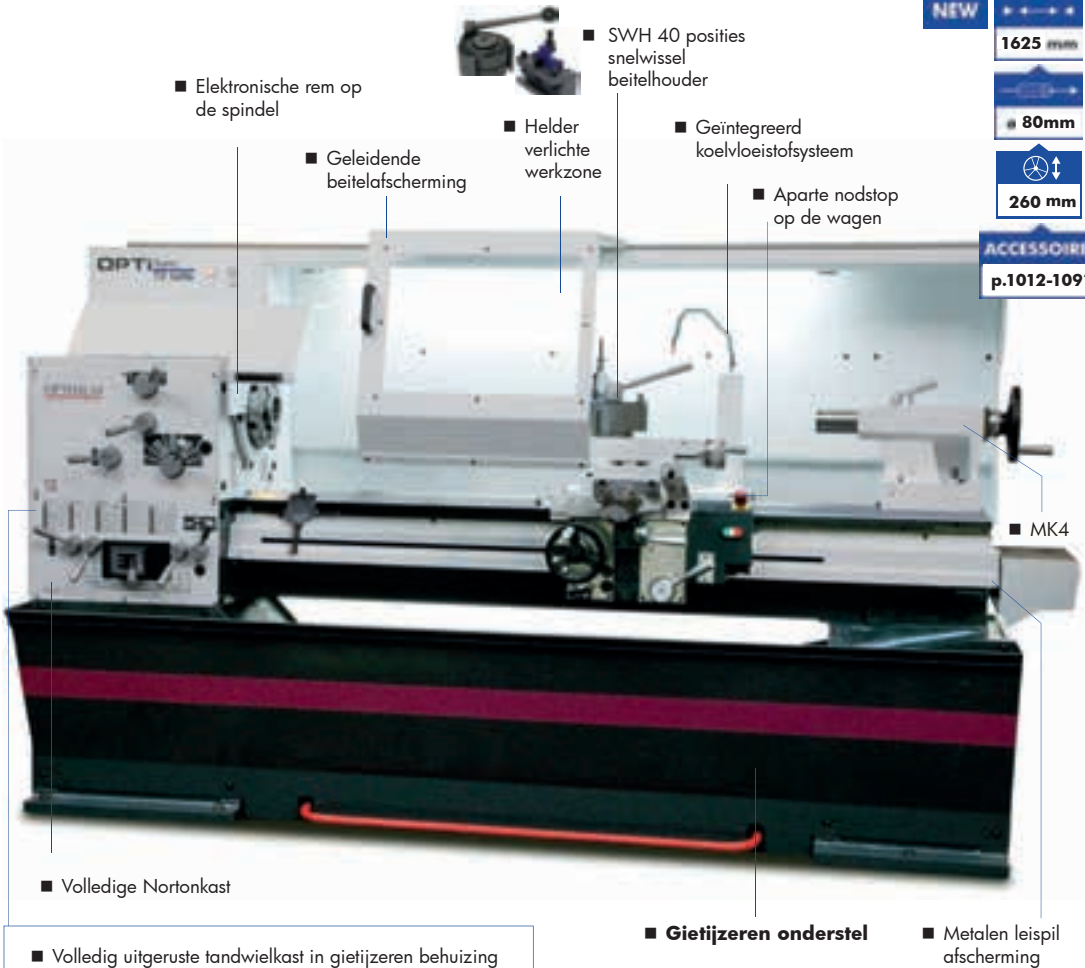

- Volledig uitgeruste tandwielkast in gietijzeren behuizing
Geen tandwielen meer wisselen



Standaard geleverd met :

- Reductiehuls MK5 – MK4
- 2 Vaste centers MK4
- Spatwand (gemonteerd)
- Klauwplaat en beitel afscherming
- 40 positie snelwissel beitelhouders met 1 vierkante beitelhouders en 1 voor ronde beitels
- Koelvloeistofsysteem
- Draadsnijlklok
- Halogeen machineverlichting

- Bedieningsleutels
- Nederlandstalige handleiding, opschriften, CE kenmerk, en CE-attest volgens Machine richtlijn 2006/42/CE, Laagspanningsrichtlijn 2006/95/CE en EMC Richtlijn 2004/108/CE

Vergeet uw Premium klauwplaten en brillen niet bij te bestellen.

Montage en ingebruikname machine zijn niet inbegrepen.



Premium precisie lei- en voedingsas draaibank.

Argumenten, die in kwaliteit, prestatie en prijs overtuigen:

- **Machined en onderstel uit sterk geribd speciaal Europees gietijzer.**
- Hoge vastheid van de spindelbehuizing door sterk geribd 25 GG gietijzer
- **Spildoorlaat 80 mm**
- Geharde en geslepen dwarsspindel garandeert een enorme nauwkeurigheid en haalbaarheid
- Door een hoge spananafname tijdens de schraapbewerking, kunnen de fijnste oppervlakten geproduceerd worden en de geringste toleranties verkregen worden.
- Heel groot bereik van draad snijden en voedingen, **zonder het wisselen van tandwielen in de tandwielkast**
- Geharde en geslepen precisie prismabed geleidingen
- Hoogwaardig gietijzeren onderstel.
- Perfect lopende hoofdspindel over precisie kogellagers
- Mechanische uitschakeling van langvoeding van de bedgeleidingen over 4 instelbare excenters.
- **Elektronische rem op de hoofdspindel**
- Alle bedieningselementen (elektrisch) centraal te bereiken
- Spindelopname Camlock DIN ISO 702:2 Nr. 8
- Hoge en precieze afwerkinggraad
- Tandwielen en assen zijn gehard en geslepen, lopend in een oliebad met precisie lagers
- Aparte noodstop, motorbeveiliging en vergrendelbare hoofdschakelaar
- Centraal smeersysteem voor het bed.
- **40 positie snelwissel beitelhoeder met 1 beitelhoeder voor vierkante beitels en 1 voor ronde beitels**
- 4 weg lengteaanslag
- Degelijke machineverlichting over het ganse bed
- Groot gedimensioneerde spatwand met glijdende beitelafscherming
- **Metalen afscherming van de leispil en moerwijs**
- Voetrem
- Klauwplaat afscherming met microscharakelaar
- Alle geleidingen door middel van spijlijsten zonder speling na stelbaar.
- Uiterst krachtige, onderhoudsvrije motor van 5,5 kW.

Order nr.		713433360
Orig. nr.		TZ6222
Capaciteit		
Centerhoogte	mm	310
Centerafstand	mm	2.225
Draaidiameter boven bed	mm	620
Draaidiameter boven slede	mm	425
Draaidiameter zonder bedbrug	mm	880
Draailengte in de bedbrug	mm	200
Bedbreedte	mm	350
Kop		
Aantal snelheden		12
Spindeltoerental	min-1	30-1.500
Spilkonus	MK	5
Spilneus Camlock DIN55029		D1-8"
Spilboring	mm	80
Draadstappen en voeding		
Langvoeding	mm/O	0.05-1.5
Dwarsvoeding	mm/O	0.025-0.75
Draadsnijden metrisch	M	0.5-15
Draadsnijden duim	Gg/1"	60-2
Trapeziumdraad	D.P.	4-120
Modulaire draad	M.P.	0.25-7.5
Geleiding en wagen		
Rijweg beitel slede	mm	165
Rijweg dwars slede	mm	365
Hoogte beitelhouder	mm	25x25
Losse kop		
Konus losse kop	MK	4
Koers losse kop	mm	180
Elektrische aansluiting		
Spanning	V	3x400
Vermogen motor	kW	5.5
Vermogen motor koelpomp	W	60
Gewicht	kg	2020,00
Afmetingen (l x b x h)	mm	3600 x 1060 x 1830
Prijs	€	29.690,00

PREMIUM

TZ6222

NEW

2225 mm

80mm

310 mm

ACCESSOIRES
p.1012-1091

■ Elektronische rem op de spindel



■ SWH 40 posities snelwissel beitelhouder

■ Geleidende beitelafscherming

■ Helder verlichte werkzone

■ Geïntegreerd koelvloeistofstelsysteem

■ Aparte nodstop op de wagen

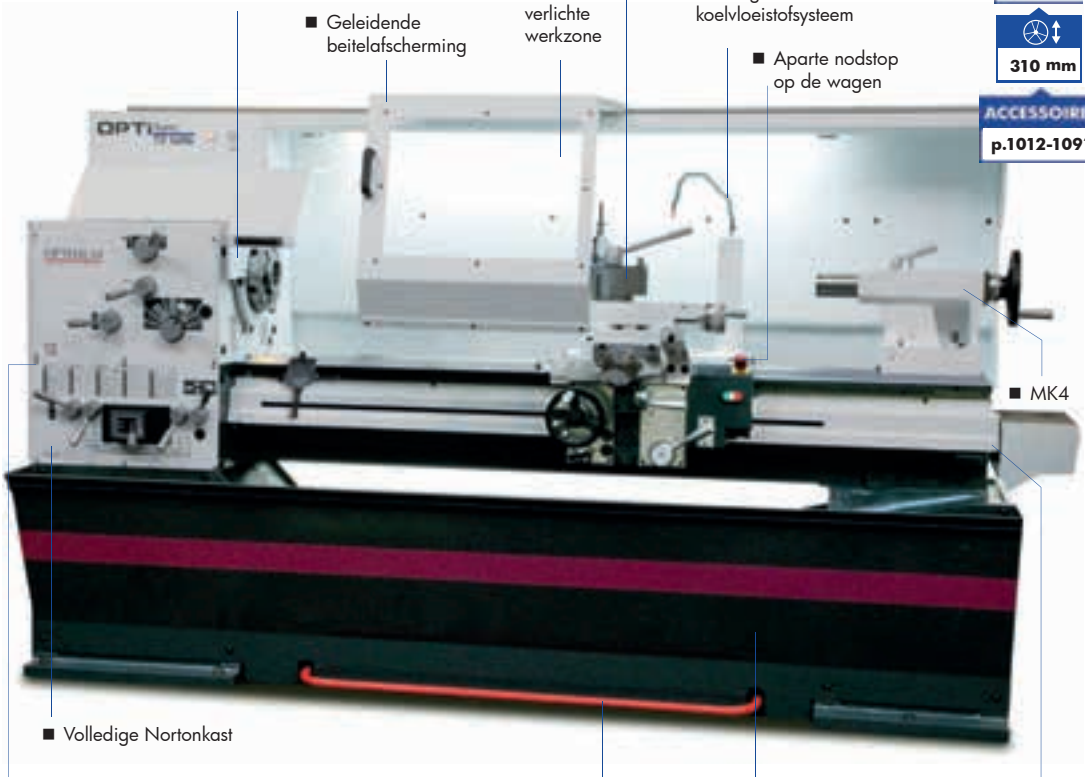

■ MK4

■ Volledige Nortonkast

■ Volledig uitgeruste tandwielkast in gietijzeren behuizing
Geen tandwielen meer wisselen

■ Voetrem

■ Gietijzeren onderstel

■ Metalen leispil afscherming



Standaard geleverd met :

- Reductiehuls MK5 – MK4
- 2 Vaste centers MK4
- Spatwand (gemonteerd)
- Klauwplaat- en beitel afscherming
- 40 positie snelwissel beitelhouder met 1 vierkante beitelhouder en 1 voor ronde beitels
- Koelvloeistofstelsysteem
- Draadsnijlklok
- Halogeen machineverlichting

- Bedieningsleutels
- Nederlandstalige handleiding, opschriften, CE kenmerk, en CE-attest volgens Machine richtlijn 2006/42/CE, Laagspanningsrichtlijn 2006/95/CE en EMC Richtlijn 2004/108/CE

Vergeet uw Premium klauwplaten en brillen niet bij te bestellen.

Montage en ingebruikname machine zijn niet inbegrepen.

CNC freesmachines

OPTI

Compacte, budgetvriendelijke CNC freesmachine met professionele Siemens 808D sturing en servo aandrijving. Ideaal voor prototypebouw en opleidingcentra.

- Stabiele CNC freesmachine met professionele Siemens Sinumerik 808D sturing
- HIWIN kogelomloopspindels op de drie assen.
- Uiterst precieze en stabiele zwaluwstaartgeleiding, vrij van speling door de instelbare spelijsen.
- Bescherming van de Z-as tegen spaanders en koelmiddel.
- Elektronisch gestuurde aandrijving.
- Compacte, beveiligde behuizing. Kantelbaar display.
- Draagbare afstandsbediening (MPG) met verlengsnoer voor de tafel, ideaal voor een snelle nulpuntbepaling. Voorzien van een noodstop.
- De werkruimte is goed zichtbaar vanaf drie zijden, afgeschermd door transparante, duurzame en uiterst grote Macrolon panelen.
- Voordeur uitgerust met veiligheidsschakelaar.
- Dubbelzijdige voet, die vooraan ruimte biedt voor de koeltank en opbergruimte, achteraan voor het elektronisch systeem
- Gesloten koelvloeistofsysteem met koelpomp. Tankinhoud 10 liter.
- Overzichtelijke elektrische kast, met genummerde bedrading.
- Centrale smering.
- Signaallicht.
- Actieve snelheidscontrole van de spindel via de Siemens sturing.

Uitmuntende prestatie. Gewoonweg eenvoudig. SIEMENS SINUMERIK 808 D

- Eenvoudige, intuïtieve gebruikersinterface.
- Sinumerik gebruikersinterface Basic met Sinumerik startgids voor een nieuwe dialoog gebaseerde gebruikersondersteuning, die u doorheen de machine instellingen zal loodsen en reduceert de insteltijd tot een minimum.
- 7.5" kleuren LCD scherm
- 80-bits nano nauwkeurigheid aandrijvingen
- Sinumerik MDynamics (cyclus 832)
- DIN / ISO programmeren
- Contourberekening
- Online Help
- Max. 3 interpolerende assen
- Geheugen grootte 1,25 MB (uitbreidbaar via USB)
- 50 instelling vooruitziend
- Metrisch / inch omschakelen
- Program GUIDE BASIC

Order nr.		713500123 
Orig. nr.		M2LS CNC
Spanning	V	1x230
Freescapaciteit vlakfrees St.37	mm	52
Freescapaciteit vingfrees St.37	mm	16
Rijweg X-as	mm	480
Rijweg Y-as	mm	155
Rijweg Z-as	mm	280
Afmetingen tafel (b x d)	mm	700x180
Afmetingen T-groeven/afstand	mm	12 / 3 / 63
Vermogen koelpomp	W	40
Spilopname	MK	2 / M10
Voeding X, Y en Z-as	mm/min	2000
Uitlading	mm	185
Aantal snelheden		2 (traploos)
Totaal verbruik	kW	1
Aandrijfmotor	kW	0,850
Snelheden (1)		90-1480
Snelheden (2)	tpm	150-3000
Maximum belastbaar gewicht	kg	55
Tankinhoud	l	10
Gewicht	kg	380,00
Afmetingen (l x b x h)	mm	1620 x 895 x 2085

M2LS CNC

MK2/M10

NEW



VERPL.

X: 480mm
Y: 155mm
Z: 280mm

Leveringsomvang:

- Datakabel RS 232
- Siemens CD
- Machineverlichting
- Kegeldoorn MK2/M10 B16
- MPG (manuele puls generator)

- Bedieningsgereedschap - Koelpomp
- Nederlandstalige handleiding, opschriften, CE
- kenmerk, en CE-attest volgens Machine richtlijn 2006/42/CE, Laagspanningsrichtlijn 2006/95/CE en EMC Richtlijn 2004/108/CE

CNC gestuurde machines



Stabiele CNC machinecenter met nieuwe Siemens sturing 808D.

Overtuigende argumenten: kwaliteit, efficiëntie en prijs.

- Lineaire geleidingen op alle assen
- Alle assen zijn voorzien van kwaliteit kogelomloopspindels
- Automatisch gereedschapmagazijn voor 8 gereedschappen, pneumatisch gestuurd. Min. 7 bar beschikbaar.
- Solide, precieze kruistafel, groot gedimensioneerd en precisie bewerkte oppervlakte voorzien van 3 T-gleuven
- Sterk, geribde machinebasis
- Centraal automatisch smeersysteem van de geleidingen, verlengt de levensduur van de machine en reduceert service.
- Krachtige servomotoren in alle assen.- Verdraaibaar bedieningspaneel
- Siemens Sinumerik 808D op PC gratis verkrijgbaar (Computer werkstation)
- Siemens 808D in het Engels - Inclusief twee jaar Siemens garantie
- Metalen balbescherming van de assen tegen spaanders en koelmiddel.
- Compacte, beveiligde behuizing. Kantelbaar display.
- Draagbare afstandsbediening (MPG) met verlengsnoer voor de tafel, ideaal voor een snelle nulpuntbepaling. Voorzien van een noodstop.
- De werkruimte is goed zichtbaar vanaf drie zijden, afgeschermd door transparante, duurzame en uiterst grote Macrolon panelen.
- Voordeur uitgerust met veiligheidsschakelaar.
- Dubbelzijdige voet, die vooraan ruimte biedt voor opbergruimte, achteraan voor het elektronisch systeem, spanen opvangbak, alsook het koelvloeistofsysteem
- Gesloten koelvloeistofsysteem met koelpomp. Tankinhoud 50 liter.
- Overzichtelijke elektrische kast, met genummerde bedrading.
- Status signaallicht.
- Siemens sturing voorzien van USB en RS232 aansluiting.

Uitmuntende prestatie. Gewoonweg eenvoudig. SIEMENS SINUMERIK 808 D

- Eenvoudige, intuïtieve gebruikersinterface.
- Sinumerik gebruikersinterface Basic met Sinumerik startgids voor een nieuwe dialoog gebaseerde gebruikersondersteuning, die u doorheen de machine instellingen zal loodsen en reduceert de insteltijd tot een minimum.
- 7.5" kleuren LCD scherm
- 80-bits nano nauwkeurigheid aandrijvingen
- Sinumerik MDynamics (cyclus 832)
- DIN / ISO programmeren
- Contourberekening
- Online Help
- Max. 3 interpolerende assen
- Geheugen grootte 1,25 MB (uitbreidbaar via USB)
- 50 instelling vooruitziend
- Metrisch / inch omschakelen
- Program GUIDE BASIC

Order nr.	713500430	
Orig. nr.		F4 CNC
Spanning	V	3x400
Totaal verbruik	kW	8,5
Aandrijfmotor	kW	2,2
Torsieaandrijfmotor	Nm	14
Koelvloeistofmotor	kW	0,095
Luchtdrukaansluiting	bar	Min 7
Spilneus		BT30
Freeskop maximum afmetingen	mm	65
Maximum schachtopname frezen	mm	30
Herhaalnauwkeurigheid	mm	+/- 0,015
Positioneernauwkeurigheid	mm	+/- 0,015
Aantal gereedschappen		8
Type		discus
Maximum gereedschapsdiameter	mm	70
Maximum gereedschapsgewicht	kg	6
Wisseltijd - tool-to-tool	sec	8
X-as (1)	mm	310
Y-as (1)	mm	200
Z-as (1)	mm	300
X-as servomotor koppel	Nm	3,3
Y-as servomotor koppel	Nm	5
Z-as servomotor koppel	Nm	5
Ijlgang X, Y, Z-as	mm/min	10000
Snelheden (2)	tpm	50 - 9.000
Afstand spil-tafel	mm	90 - 390
Tafel lengte x breedte	mm	690x210
T-gleuven grootte/aantal/afstand		16/3/63
Maximum belastbaar gewicht	kg	100
Tankinhoud	l	50
T-gleuven grootte/aantal/afstand		16/3/63
Gewicht	kg	1580,00
Afmetingen (l x b x h)	mm	1800 x 1720 x 2000

F4 CNC

BT30



- Gereedschapssysteem:
 - Automatisch d.m.v. magazijn voor 8 gereedschappen
 - Max. gereedschapsdiameter 70 mm



- Elektrische kast:
 - Overzichtelijke structuur
 - Groot gedimensioneerd

- 50-9000 tpm
BT30 spindel



1580Kg



- Uitmuntende prestatie. Gewoonweg eenvoudig. SIEMENS SINUMERIK 808 D
 - Eenvoudige, intuïtieve gebruikersinterface.
 - Sinumerik gebruikersinterface Basic met Sinumerik startgids voor een nieuwe dialoog gebaseerde gebruikersondersteuning, die u doorheen de machine instellingen zal loodsen en reduceert de insteltijd tot een minimum.
 - 7.5" kleuren LCD scherm
 - 80-bits nano nauwkeurigheid aandrijvingen
 - Sinumerik MDynamics (cyclus 832)
 - DIN / ISO programmeren
 - Contourberekening
 - Max. 3 interpolerende assen
 - Geheugen grootte 1,25 MB (uitbreidbaar via USB)
 - 50 instelling vooruitziend
 - Metrisch / inch omschakelen
 - Program GUIDE BASIC, Online Help

Leveringsomvang:

- Datakabel RS 232
- Siemens CD
- MPG (manuele puls generator)
- Bedieningsgereedschap - Koelpomp
- Nederlandstalige handleiding, opschriften, CE

- kenmerk, en CE-attest volgens Machine richtlijn 2006/42/CE, Laagspanningsrichtlijn 2006/95/CE en EMC Richtlijn 2004/108/CE

Vraag een vrijblijvende demonstratie van deze machine aan



F80CNC. Degelijke, compacte oplossing van een CNC machinecenter met nieuwe Siemens sturing 808D.

Overtuigende argumenten: kwaliteit, efficiëntie en prijs.

- Lineaire geleidingen op alle assen, beschermd met speciale metalen balbeschermingen.
- Alle assen zijn voorzien van kwaliteit kogelomloopspindels
- Spindelmotor met 8.000 min⁻¹ als standaard
- Automatisch gereedschapsmagazijn voor 10 gereedschappen, pneumatisch gestuurd. Min. 7 bar beschikbaar.
- Solide, precieze kruistafel, groot gedimensioneerd en precisie bewerkte oppervlakte voorzien van 3 T-gleuven
- Sterk, geribde machinebasis
- Centraal automatisch smeersysteem van de geleidingen, verlengt de levensduur van de machine en reduceert service.
- Krachtige servomotoren in alle assen.
- Verdraaibaar bedieningspaneel
- Draagbare afstandsbediening (MPG) met verlengsnoer voor de tafel, ideaal voor een snelle nulpuntbepaling. Voorzien van een noodstop.
- De werkruimte is goed zichtbaar vanaf drie zijden, afgeschermd door transparante, duurzame en uiterst grote Macrolon panelen.
- Voordeur uitgerust met veiligheidsschakelaar.
- Gesloten koelvloeistofsysteem met koelpomp. Tankinhoud 160 liter.
- Overzichtelijke elektrische kast, met genummerde bedrading.
- Status signaallicht.
- Balanceer kettingsysteem om de vibraties van de freeskop tot een minimum te herleiden.
- Helder verlichte werkomgeving door geïntegreerde LED machineverlichting.
- Siemens sturing voorzien van USB en RS232 aansluiting.

Uitmuntende prestatie. Gewoonweg eenvoudig. SIEMENS SINUMERIK 808 D

- Eenvoudige, intuïtieve gebruikersinterface.
- Sinumerik gebruikersinterface Basic met Sinumerik startgids voor een nieuwe dialoog gebaseerde gebruikersondersteuning, die u doorheen de machine instellingen zal loodsen en reduceert de insteltijd tot een minimum.
- 7.5" kleuren LCD scherm
- 80-bits nano nauwkeurigheid aandrijvingen
- Sinumerik MDynamics (cyclus 832)
- DIN / ISO programmeren
- Contourberekening
- Online Help
- Max. 3 interpolerende assen
- Geheugen grootte 1,25 MB (uitbreidbaar via USB)
- 50 instelling vooruitziend
- Metrisch / inch omschakelen
- Program GUIDE BASIC
- Siemens Sinumerik 808D op PC gratis verkrijgbaar (Computer werkstation)
- Siemens 808D in het Engels - Inclusief twee jaar Siemens garantie

Order nr.	713501080	
Orig. nr.	F80 CNC	
Spanning	V	3x400
Totaal verbruik	kW	9,5
Aandrijfmotor	kW	2,2
Torsieaandrijfmotor	Nm	14
Koelvloeistofmotor	kW	0,65
Spilneus	ISO30 / BT30	
Freeskop maximum afmetingen	mm	65
Maximum schachtopname frezen	mm	30
Herhaalnauwkeurigheid	mm	+/- 0,015
Positioneernauwkeurigheid	mm	+/- 0,015
Aantal gereedschappen		10
Type		discus
Maximum gereedschapdiameter	mm	104
Maximum gereedschapsgewicht	kg	6
X-as (1)	mm	400
Y-as (1)	mm	225
Z-as (1)	mm	375
X-as servomotor koppel	Nm	5
Y-as servomotor koppel	Nm	5
Z-as servomotor koppel	Nm	6
Ijlgang X, Y, Z-as	mm/min	10000
Snelheden (2)	tpm	50-8000
Afstand spil-tafel	mm	70-475
Tafel lengte x breedte	mm	800x260
Maximum belastbaar gewicht	kg	150
T-gleuven grootte/aantal/afstand		16/5/50
Wisseltijd tool-to-tool	s	7
Inhoud koeltank	l	160
Gewicht	kg	1900,00
Afmetingen (l x b x h)	mm	1925 x 1600 x 2070



F80 CNC

BT30

NEW



■ 10 gereedschapssysteem



■ Overzichtelijke elektrische kast

■ 50-8000 tpm
BT30 spindel



■ Heldere werkzone verlichting

■ Siemens 808D Software
Advanced machine:
mogelijkheid 4de as.



1900Kg

Software Advanced machine: mogelijkheid 4de as.

■ MPG

VERPL.

X: 400mm
Y: 225mm
Z: 375mm

Leveringsomvang:

- Datakabel RS 232
- Siemens CD
- MPG (manuele puls generator)
- Bedieningsgereedschap - Koelpomp

- Nederlandstalige handleiding, opschriften, CE
- kenmerk, en CE-attest volgens Machine richtlijn 2006/42/CE, Laagspanningsrichtlijn 2006/95/CE en EMC Richtlijn 2004/108/CE.

OPTI

De compacte oplossing voor het produceren van kleine series in kleine en middel grote ondernemingen, en opleidingcentra met nieuwe Siemens sturing 808D.

Overtuigende argumenten: kwaliteit, efficiëntie en prijs.

- Robuuste machine van 2.800 kg.
- Lineaire geleidingen op alle assen, beschermd met speciale metalen balbeschermingen.
- Alle assen zijn voorzien van kwaliteit kogelomloopspindels
- Spindelmotor met 8.000 min-1 als standaard
- Automatisch gereedschapsmagazijn voor 12 gereedschappen, pneumatisch gestuurd. Min. 7 bar beschikbaar.
- Solide, precieze kruistafel, groot gedimensioneerd en precisie bewerkte oppervlakte voorzien van 3 T-gleuven
- Sterk, geribde machinebasis
- Centraal automatisch smeersysteem van de geleidingen, verlengt de levensduur van de machine en reduceert service.
- Krachtige servomotoren in alle assen.
- Verdraaibaar bedieningspaneel
- Draagbare afstandsbediening (MPG) met verlengsnoer voor de tafel, ideaal voor een snelle nulpuntbepaling. Voorzien van een noodstop.
- De werkruimte is goed zichtbaar vanaf drie zijden, afgeschermd door transparante, duurzame en uiterst grote Macrolon panelen.
- Voordeur uitgerust met veiligheidsschakelaar.
- Gesloten koelvoelstofsysteem met koelpomp. Tankinhoud 200 liter.
- Overzichtelijke elektrische kast, met genummerde bedrading.
- Status signaallicht.
- Balanceer kettingsysteem om de vibraties van de freeskop tot een minimum te herleiden.
- Helder verlichte werkomgeving door geïntegreerde LED machineverlichting.
- Siemens sturing voorzien van USB en RS232 aansluiting.

Uitmuntende prestatie. Gewoonweg eenvoudig. SIEMENS SINUMERIK 808 D

- Eenvoudige, intuïtieve gebruikersinterface.
- Sinumerik gebruikersinterface Basic met Sinumerik startgids voor een nieuwe dialoog gebaseerde gebruikersondersteuning, die u doorheen de machine instellingen zal loodsen en reduceert de insteltijd tot een minimum.
- 7.5" kleuren LCD scherm
- 80-bits nano nauwkeurigheid aandrijvingen
- Sinumerik MDynamics (cyclus 832)
- DIN / ISO programmeren
- Contourberekening
- Online Help
- Max. 3 interpolerende assen
- Geheugen grootte 1,25 MB (uitbreidbaar via USB)
- 50 instelling vooruitziend
- Metrisch / inch omschakelen
- Program GUIDE BASIC
- Siemens Sinumerik 808D op PC gratis verkrijgbaar (Computer werkstation)
- Siemens 808D in het Engels - Inclusief twee jaar Siemens garantie

Order nr.		713501105 
Orig. nr.		F105 CNC
Spanning	V	3x400
Totaal verbruik	kW	10
Aandrijfmotor	kW	5,5
Torsieaandrijfmotor	Nm	35
Koelvoelstofmotor	kW	0,65
Spilneus		ISO40 / BT40
Freeskop maximum afmetingen	mm	75
Maximum schachtopname frezen	mm	35
Herhaalnauwkeurigheid	mm	+/- 0,01
Positioneernauwkeurigheid	mm	+/- 0,01
Aantal gereedschappen		12
Type		discus
Maximum gereedschapsdiameter	mm	104
Maximum gereedschapsgewicht	kg	6
Wisseltijd - tool-to-tool	sec	7
X-as (1)	mm	550
Y-as (1)	mm	305
Z-as (1)	mm	460
X-as servomotor koppel	Nm	5
Y-as servomotor koppel	Nm	5
Z-as servomotor koppel	Nm	10
Ijlgang X, Y, Z-as	mm/min	10000
Snelheden (Z)	tpm	10-8000
Afstand spil-tafel	mm	100-600
Tafel lengte x breedte	mm	800x320
T-gleuven grootte/aantal/afstand		14/3/100
Maximum belastbaar gewicht	kg	300
Inhoud koeltank	l	200

F105 CNC

BT40

NEW



■ 12 gereedschapssysteem



■ Overzichtelijke elektrische kast



■ Heldere werkzone verlichting

■ 10-8000 tpm
BT40 spindel

■ Siemens 808D
Software
Advanced machine:
mogelijkheid 4de as.



2800Kg

■ Software Advanced machine: mogelijkheid 4de as.

VERPL.

X: 550mm
Y: 305mm
Z: 460mm



■ Centrale automatische smering

Leveringsomvang:

- Datakabel RS 232
- Siemens CD
- MPG (manuele puls generator)
- Bedieningsgereedschap - Koelpomp

- Nederlandstalige handleiding, opschriften, CE
- kenmerk, en CE-attest volgens Machine richtlijn 2006/42/CE, Laagspanningsrichtlijn 2006/95/CE en EMC Richtlijn 2004/108/CE.



De Optimum Premium CNC machine centers onderscheiden zichzelf door prestatie, snelheid, nauwkeurigheid en duurzaamheid. Overtuigende argumenten: kwaliteit, efficiëntie en prijs.

- CNC Sturing Siemens 828D, power pack: Sinumerik veiligheidintegratie, residuele materiaaldetectie en bediening, Shopmill werkprogramma, beheren netwerk aandrijving, 3D simulatie, tekenen.
- Inclusief 2 jaar Siemens waarborg.
- Zware uitvoering, voor hoge productiviteit en betrouwbaarheid
- Lineaire geleidingen voor hoge ijlgang snelheden in alle assen - Automatisch gereedschapswisselaar 16 gereedschappen ISO40 DIN69871, paraplu systeem.
- Sterk geribde en torsievrij gietijzeren onderstel, vervaardigd uit kwaliteit Meehanieten gietijzer.
- Werktafel voorzien van precisie geslepen T-gleuven
- Flush systeem voorzien aan de achterzijde om spanen eenvoudig weg te sproeien.
- Precisie geslepen voorafgespannen hoge prestatie kogelomloopspindels in alle assen (\varnothing 32 x P8 x C3)
- Krachtige directe servo aandrijving op de kogelomloopspindels in alle 3 assen
- Manueel, elektronisch handwiel (MPG Manual Pulse Generator)
- Automatische spanentransporteur
- schroefmodel met kantelbare spanen opvangbak
- Pneumatisch pistool voor eenvoudig reinigen van de werktafel
- RJ45 plug connectie, USB verbinding en 230V aansluiting
- Koelvoelstofuitrusting met koeltank met een capaciteit van 210 liter
- Warmtewisselaar in de elektrische kast voorkomt fouten door oververhitting van elektrische en CNC componenten.
- Tal van opties mogelijk: koeling door spindel op 20 en 70 bar, bi-directionele gereedschapswisselaar 24 tools, snellere spindels bvb 12.000 tpm, 4de en 5de as, etc.

Order nr.	713511210	
Orig. nr.		F150TC
Spanning	V	3x400
Uitlading	mm	480
Totaal verbruik	kW	25
Aandrijfmotor	kW	12
Torsieaandrijfmotor	Nm	57
Koelvoelstofmotor	kW	1,27
Spilneus		ISO40 DIN69871
Freeskop maximum afmetingen	mm	63
Maximum schachtopname frezen	mm	32
Herhaalnauwkeurigheid	mm	0,005
Positioneer nauwkeurigheid	mm	+/- 0,005
Aantal gereedschappen		16
Type		discus
Maximum gereedschapdiameter	mm	89
Maximum gereedschapsgewicht	kg	8
Wisseltijd - tool-to-tool	sec	7
X-as (1)	mm	760
Y-as (1)	mm	430
Z-as (1)	mm	460
X-as servomotor koppel	Nm	6
Y-as servomotor koppel	Nm	6
Z-as servomotor koppel	Nm	11
Voedingen en ijlgang		-
Voeding X, Y en Z as	mm/min	10.000
Ijlgang X, Y, Z-as	mm/min	24.000
Snelheden (2)	tpm	10-10.000
Werktafel		-
Afstand spil-tafel	mm	102-562
Tafel lengte x breedte	mm	900x410
T-gleuven grootte/aantal/afstand		16/4/102
Maximum belastbaar gewicht	kg	350
Afmetingen	mm	-
Tankinhoud	l	210
Gewicht	kg	3520,00
Afmetingen (l x b x h)	mm	2540 x 2250 x 2380

PREMIUM

F150TC

BT40

■ SO40 DIN69871
10.000 tpm

■ Gereedschapwisselaar
16 tools - optie 24 tools

■ Warmtewisselaar

■ Siemens 828D



3500Kg

■ Spanentransporteur

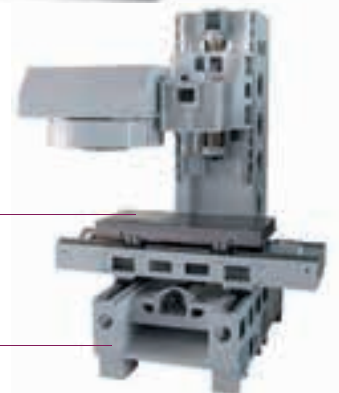

■ Precisiegeslepen

■ Robuuste zwaar geribde
Meehanieten machinebasis

VERPL.

X: 760mm
Y: 430mm
Z: 460mm

Standaard uitrusting:

- Residuele materiaaldetectie en bewerking voor contour pockets en stock removal
- Shop mill
- Network drive management
- 3D simulaties van het afgewerkt stuk
- Gelijktijdig opnemen
- Safety geïntegreerd
- Sinumerik bediening
- EMC
- Blaaspistool
- Spanen spoelsysteem

- Machineverlichting
- Gereedschapswisselaar 16 posities carousel type
- Spanentransporteur - schroeftype
- Warmte wisselaar
- 6 trillingsdempers
- Mogelijkheid om 828D in verschillende talen te plaatsen, waaronder Nederlands, Frans, Duits, Engels, etc.

Vraag een vrijblijvende demonstratie van deze machine aan

OPTImill®
F 310TC



OPTIturn®
L 44CNC



OPTIturn®
S 600



OPTimill®
F 410TC



OPTiturn®
L 440



OPTiturn®
S 750



Digitale uitlezing

OPTIMUM



De nieuwe, compacte 3 assen digitale magneetbandmeetsysteem voor freesmachines en draaibanken, voorzien van toerentalweergave.

- Compacte, digitale 3 assen positieaanduiding voor freesmachines (X, Y en Z) en voor draaibanken (X, Z en ZO)
- Voor het aanduiden van de posities
- Toerentalweergave mogelijk
- 3 incrementele ingangen
- 4 lijnen display
- Gebruiksvriendelijk bedieningspaneel
- Universeel te gebruiken op andere merken.

Omvat:

- Magneetmeetsysteem
- 3 stuks magneetsensoren
- Houder op 2 punten instelbaar en magneetvoet
- Netsnoer
- Magneetband met stalen beschermingsband

MPA4S: kit inclusief 1100 mm magneetband (voor bvb BF20(L), TU2807, etc.)

MPA4L: kit inclusief 2000 mm magneetband (voor bvb BF46, D360, etc.)

MPU: werkplaatmontage MPA4.

Order nr.	713383922 M	713383924 M	719000420 M
Orig. nr.	MPA4S	MPA4L	MPU
Voor type	BF20L - TU2807	BF46 - D360	montage
Prijs	€ 875,00	879,00	490,00

OPTIMUM



Afzonderlijke onderdelen MPA4.

- Magneetband wordt berekend per cm en wordt geleverd met een staalband
- Magneetsensor, dient per as aangekocht te worden, om feedback te kunnen geven van de positie aan de teller MPA4
- Afzonderlijke teller MPA4

Er bestaat ook de mogelijkheid om de MPA4 uit te rusten met glaslinalen, daarvoor hebt u een actieve leeskop per as nodig, 713383932.

Order nr.	713383921 M	713383931 M	713383941 M
Orig. nr.	MPA4	3383931	3383941
Omschrijving	digitale display	magneetsensor MS100/1	magneetband MB100 per cm
Prijs	€ 490,00	104,00	2,00

OPTIMUM



Digitale 3-assige positieaanduiding.

- Duidelijke vermindering van de werkfouten
- Eenvoudige bediening
- Hogere arbeidsnauwkeurigheid
- Foutenmarge wordt verlaagd
- Overzichtelijk, geordende bedieningstoetsen
- Glansvrije display
- LED aanduiding tot 8 aanduidingen
- Spatwaterbestendige en gesloten bedieningspaneel
- Hoogwaardige Alu behuizing
- Zowel voor freesmachines (X-Y-Z), evenals voor draaibanken (X-Z-Zo) toegepast kan worden.
- Bij stroomonderbreking worden de gegevens van het permanente geheugen opgeslagen.
- Elektrische aansluiting 230V

Mogelijke functies:

- Rekenmachine
- Absolute / incrementele functie
- Askoppeling (Som Z)
- SUB D aansluitingen
- Keuzeaanduiding mm/inch
- Gatencirkel berekenen
- Coördinaten in een cirkel
- Gaten boren in een raster
- Keuze telrichting
- Lineaire foutencompensatie van de assen
- Optelling van de waarde voor Z en ZO als som is mogelijk
- Keuzeaanduiding in waarde van radius of diameter

Te gebruiken in combinatie met meetlinalen 713384108 t.e.m. 713384300.

Optimum heeft in het gamma eveneens een digitale uitlezing met snelheidsaanduiding DPA2000S, 713384010, deze kunt u terug vinden op onze website.

Order nr.	713384001 M
Orig. nr.	DPA2000
Prijs	€ 389,00

OPTIMUM

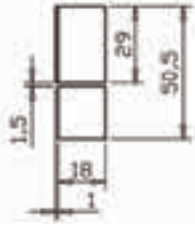

Voor ML 720 tot 1920mm
Totale lengte is ML + 166mm
Installatie lengte is ML + 132mm



Voor ML 80 tot 720mm
Totale lengte is ML + 138mm
Installatie lengte is ML + 124mm

Deze glaslinialen kunnen op de meeste draibanken, freesmachines en slijpmachines gemonteerd worden.

- Meetlat met hoogprecieze glazen meetstaaf.
- Nauwkeurigheid 5 um.
- Afleeskop met miniatuurkogellagers via een koppeling met de montagevoet verbonden.
- Door middel van een rubber afdichtflap beschermd tegen stof, spanen en spatwater.
- Flexibele metalen beschermingslang beschermt de 3m lange verbindingkabel (4m vanaf ML 620).
- De verbindingkabel is uitgerust met een 9 pin stekker
- Voor gebruik met DPA2000/DPA2000S
- Zonder montage

Voor ML 80 tot 720 mm: totale lengte is ML + 138 mm
Installatie lante is ML + 124 mm

Voor ML 720 tot 1920 mm: totale lengte is ML + 166 mm
Installatie lengte is ML + 132 mm

Order nr.	Orig. nr.	Omschrijving	Prijs €
719000410	9000410	Montage per maatlat	313,00
713384108	3384108	ML 80 MM	249,00
713384110	3384110	ML 100 MM	256,00
713384112	3384112	ML 120 MM	256,00
713384117	3384117	ML170 MM	257,00
713384122	3384122	ML 220 MM	281,00
713384127	3384127	ML 270 MM	289,00
713384132	3384132	ML320 MM	330,00
713384137	3384137	ML 370 MM	298,00
713384142	3384142	ML 420 MM	345,00
713384147	3384147	ML 470 MM	357,00
713384152	3384152	ML 520 MM	378,00
713384157	3384157	ML 570 MM	388,00
713384162	3384162	ML 620 MM	403,00
713384167	3384167	ML 670 MM	409,00
713384172	3384172	ML 720 MM	414,00
713384177	3384177	ML 770 MM	425,00
713384182	3384182	ML 820 MM	429,00
713384187	3384187	ML 870 MM	437,00
713384192	3384192	ML 920 MM	446,00
713384197	3384197	ML 970 MM	459,00
713384202	3384202	ML 1020 MM	599,00
713384225	3384225	ML 1250 MM	815,00
713384240	3384240	ML 1400 MM	955,00
713384252	3384252	ML 1520 MM	1.010,00
713384267	3384267	ML 1670 MM	1.055,00
713384294	3384294	ML 1940 MM	1.210,00
713384295	3384295	ML 2110 MM	1.315,00
713384300	3384300	ML 3000 MM	1.890,00

Meten algemeen

OPTIMUM



Universeel digitaal meetsysteem.

- Voor opbouw op rollenbaan MSR4, MSR7 en MSR10 voor een perfecte langsmeting en een exacte positionering.
- De afstand zaagsnit – startpunt meting kan opgeslagen worden als vast startpunt voor elke meting aan het begin van de rollenbaan.
- Magnetisch meetsysteem.
- Voor serie metingen met een hoge precisie van 0,1 mm.
- Automatisch inschakelen van afleesscherm.
- Meetsysteem schakelt automatisch uit bij langdurig niet-gebruik en behoudt de laatste meting in het geheugen.
- Meetnauwkeurigheid : +/- (0,025 +0,02 x meetlengte (m)).
- Opklapbare aanslag (vermindert de afstand van de meetafstand met 170 mm)
- Levensduur van de batterij tot 10 jaar.
- Rollenbaan niet inbegrepen.
- Lineaire geleiding:
 - smeervrij
 - zeer licht loop
 - slijtvast
 - corrosiebestendig
 - lage wrijvingscoëfficiënt

Order nr.	Orig. nr.	Lengte mm	Bruikbare verplaatsing mm	Gewicht kg	Afmetingen (l x b x h) mm	Prijs €
713383881	LMS1	1000	830	7,00	1100 x 110 x 70	829,00
713383882	LMS2	2000	1830	10,00	2100 x 110 x 70	929,00
713383883	LMS3	3000	2830	12,00	3100 x 110 x 70	1.130,00
713383884	LMS4	4000	3830	14,00	4100 x 110 x 70	1.195,00
713383885	LMS5	5000	4830	16,00	5100 x 110 x 70	1.395,00
713383886	LMS6	6000	5830	18,00	6100 x 110 x 70	1.539,00
713383888	LMS8	8000	7830	35,00	8100 x 110 x 70	1.699,00

SAFETY FOR YOUR MACHINE



MEER INFO OP
WWW.VYNCKIER.BIZ

YOUR YOUR MACHINES





VEILIGHEIDSAFSCHERMING VOOR **BOOR- MACHINES**

De enige die een dubbel scherm afstelling bezit

Derde generatie veiligheidsafscherming voor boormachines "Made in EU", handig ontwerp en de enige die een dubbel scherm afstelling bezit. Geschikt om te gebruiken op tafel- en kleine tot grote kolomboormachines en radiaalboormachines.

Dikwandige polycarbonaten schermen. Voorzien van een microschakelaar n.2 NC contacten, is een positief contact zoals omschreven in EN 60947-5-1. Iedere afscherming draagt het CE kenmerk en wordt bovendien geleverd met een eigen CE certificaat.

Beschermt de bediener tegen direct contact met de draaiende delen en spanen en tegen wegsplattend smeer - koelmiddel.

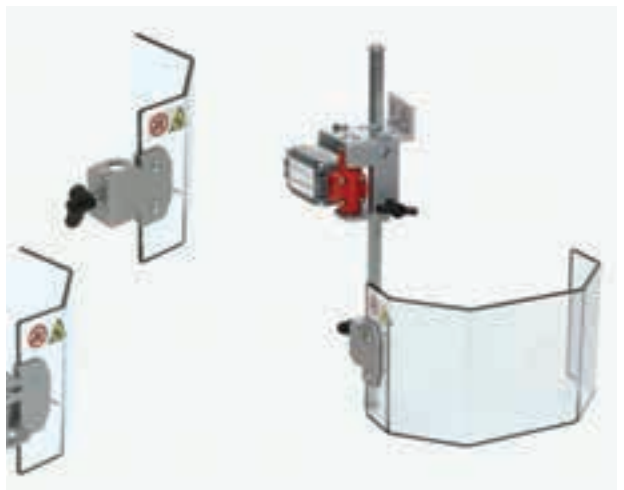



Klawwplaat bescherming

Derde generatie veiligheidsafscherming voor draaibanken "Made in EU", waaronder klauwplaat afscherming in thermogevormd materiaal of stalen frame, beitelsafscherming, afscherming van leispil, noodrem, etc. Voorzien van een microschakelaar n.2 NC contacten, is een positief contact zoals omschreven in EN 60947-5-1. Iedere afscherming draagt het CE kenmerk en wordt bovendien geleverd met een eigen CE certificaat. Beschermt de bediener tegen direct contact met het bovenste deel van de klauwplaat of bewegende delen in de klauwplaat, of tegen eventueel vastlopende werkkledij en tegen wegsplattend smeermiddel - koelvloeistof.



VEILIGHEIDSAFSCHERMING VOOR DRAAI- BANKEN





VEILIGHEIDSAFSCHERMING VOOR **FREES- MACHINES**



De perfecte bescherming tegen direct contact met draaiende delen

Derde generatie veiligheidsafscherming voor kleine boor-freesmachines, torenfreesmachines en universele freesmachines "Made in EU", universele afscherming met gelede armen, tafelafschermingen, voor horizontale als verticale spindels. Voorzien van een microschenkelaar n.2 NC contacten, is een positief contact zoals omschreven in EN 60947-5-1. Iedere afscherming draagt het CE kenmerk en wordt bovendien geleverd met een eigen CE certificaat. Beschermt de bediener tegen direct contact met de draaiende delen van de verticale of horizontale spindel en spanen en tegen wegspatend smeer – koelmiddel.

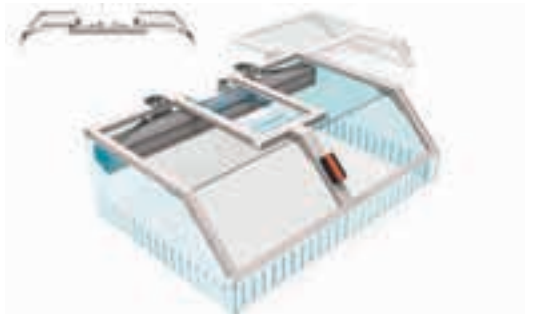



VEILIGHEIDSAFSCHERMING VOOR LASSEN EN SLIJPEN

Lassen en slijpen in een veilige omgeving

Lasscherm biedt bescherming aan personeel dichtbij las- en slijpomgevingen. Het halfranzparante scherm beschermt personeel tegen metalen spanen en spatten geproduceerd door las- en slijpprocessen. "Made in EU" volgens de geldende richtlijn UNI EN 1598

Naast het lasscherm beschikken we eveneens nog over afschermingen voor de dubbele slijpmo- lens, inschuifbare afschermkappen voor zaagmachines en veiligheid activeringshendels.

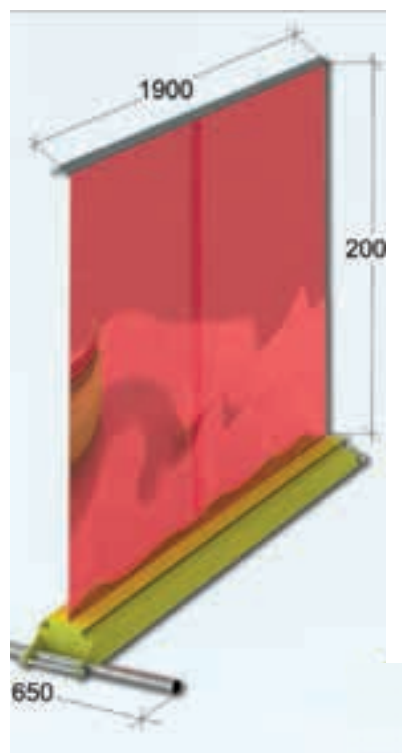



VEILIGHEIDSAFSCHERMING DOOR
VYNCKIER
SERVICE





Onze zorg, uw veiligheid

Investeer in veiligheid. Reduceer het aantal arbeidsongevallen met machines door het aanbrengen van adequate beschermingen. Deze kwalitatieve beschermingen zijn hiervoor uitermate geschikt.

Met dit uitgebreide gamma aan beschermkappen, afschermingen, afsluitingen kunt u uw bestaand machinepark in orde stellen aan de geldende machinerichtlijn.

Deze producten kunnen zowel door uzelf, uw technische dienst of onze eigen diensten worden geplaatst.

De firma VYNCKIER beschikt over een competente technische dienst die deze beschermingen op een correcte en conforme manier kan plaatsen. Vraag vrijblijvend informatie of een offerte aan zodat de veiligheid van u en uw werknemers hiermee wordt gegarandeerd en uw machinepark voldoet aan de geldende machinerichtlijn.



Voor boormachines

METALWORKS

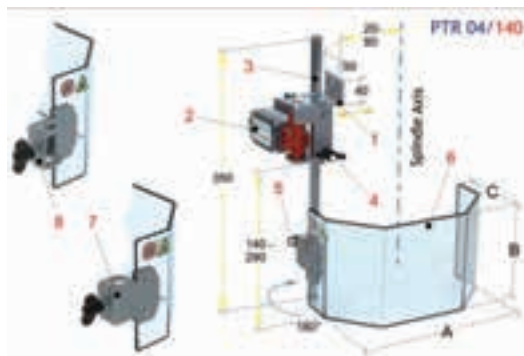

Veiligheidsafscherming voor tafel- en kleine kolomboormachines.

- Derde generatie veiligheidsafscherming voor boormachines "Made in EU", handig ontwerp en de enige met een dubbele scherm afstelling.
- Geschikt om te gebruiken voor tafel- en kleine kolomboormachines.
- Polycarbonaat scherm.
- Voorzien van een microscharakelaar n.2 NC contacten, is een positief contact zoals omschreven in EN 60947-5-1.
- Iedere afscherming draagt het CE kenmerk en wordt bovendien geleverd met een eigen CE certificaat.

- Beschermt de bediener tegen direct contact met de draaiende delen en spanen en tegen wegsplattend smeer – koelmiddel.

Opgepast: een dergelijke booraafscherming vergt telkens aanpassingen om op uw tafel- of kleine boormachine te monteren. Een veiligheidsafscherming dient geplaatst te worden door gekwalificeerd personeel. De geschatte werktijd bedraagt ongeveer 2 werkuren, mits er een noodstopcircuit aanwezig is. Bij vragen of plaatsing, kunt u altijd onze technische dienst contacteren.

Bij uw keuze van afscherming dient u rekening te houden met de boordiepte, alsook de breedte van de spil, die dient afgeschermd te worden, tevens dient u de veiligheid van de bediener in acht te nemen.

Order nr.	790008786 M	
Orig. nr.	PTR 04/140	
A	mm	200
B	mm	140
C	mm	100
Prijs	€	199,00

METALWORKS

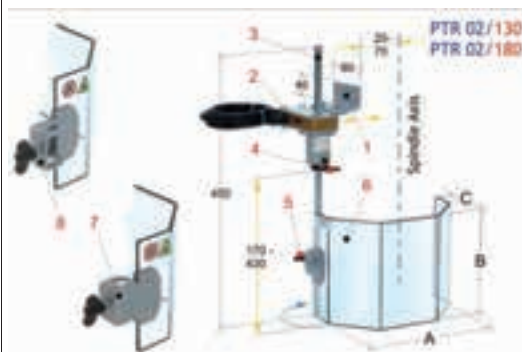

Veiligheidsafscherming voor traditionele kolomboormachines en kleine, radiaal boormachines. Derde generatie veiligheidsafscherming voor boormachines "Made in EU", handig ontwerp en de enige met een dubbele scherm afstelling. Geschikt om te gebruiken op traditionele grote kolomboormachines, pantografen en gelijkaardige machines.

Polycarbonaat scherm. Voorzien van een microscharakelaar n.2 NC contacten, is een positief contact zoals omschreven in EN 60947-5-1. Iedere afscherming draagt het CE kenmerk en wordt bovendien geleverd met een eigen CE certificaat.

- Beschermt de bediener tegen direct contact met de draaiende delen en spanen en tegen wegsplattend smeer – koelmiddel.

Opgepast: een dergelijke booraafscherming vergt telkens aanpassingen om op uw kolomboormachine te monteren. Een veiligheidsafscherming dient geplaatst te worden door gekwalificeerd personeel. De geschatte werktijd bedraagt ongeveer 2 werkuren, mits er een noodstopcircuit aanwezig is. Bij vragen of plaatsing, kunt u altijd onze technische dienst contacteren.

Bij uw keuze van afscherming dient u rekening te houden met de boordiepte, alsook de breedte van de spil, die dient afgeschermd te worden, tevens dient u de veiligheid van de bediener in acht te nemen.

Order nr.	790008782 M		790008784 M	
Orig. nr.	PTR02/130		PTR 02/180	
A	mm	230	230	
B	mm	130	180	
C	mm	115	115	
Prijs	€	242,00	253,00	

Voor freesmachines

METALWORKS

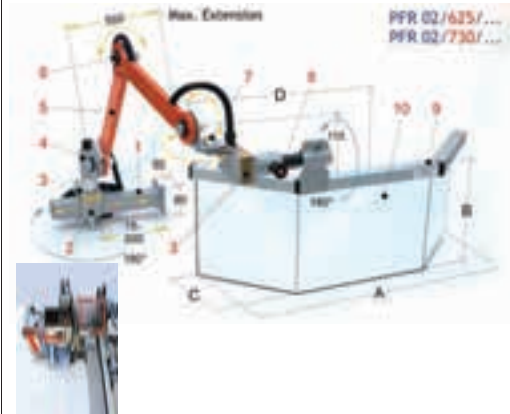

Veiligheidsafscherming voor universele freesmachines.

Derde generatie veiligheidsafscherming voor universele freesmachines "Made in EU", dankzij een bewezen systeem van wrijvende gelede armen, is het de enige die uiterst veelzijdig en beweegbaar is. Geschikt voor frequent veranderende werkoperaties.

Thermogevormd scherm in schokbestendig en olie resistent materiaal. Voorzien van een microschakelaar n.2 NC contacten, is een positief contact zoals omschreven in EN 60947-5-1. Iedere afscherming draagt het CE kenmerk en wordt bovendien geleverd met een eigen CE certificaat.

Beschermt de bediener tegen direct contact met de draaiende delen van de verticale spindel en spanen en tegen wegsplattend smeer - koelmiddel.

Bevestiging aan de basis flank, uitgerust met breed volledig doorzichtig scherm met dubbel openend systeem: 1 = scherm kan verticaal geopend worden met zijn positieknop - 2 = zwevend buiten het werkveld. Compleet met dubbele microschakelaar. Schermen zijn apart verkrijgbaar.

Opmerking: specificeer de montagezijde door de volgende suffix toe te voegen: / DX = rechts - / SX = links.

Opgepast: een veiligheidsafscherming vergt telkens aanpassingen om op uw universele freesmachine te monteren. Een veiligheidsafscherming dient geplaatst te worden door gekwalificeerd personeel. De geschatte werktijd bedraagt ongeveer 3 werkuren, mits er een noodstopcircuit aanwezig is. Bij vragen of plaatsing, kunt u altijd onze technische dienst contacteren.

Bij uw keuze van afscherming dient u rekening te houden met uw type freesmachine, meer bepaald de plaats waar de afscherming dient gemonteerd te worden, opteert uw voor een linkse of rechtse versie. Deze afscherming worden het meest geplaatst op universele freesmachines met enkel een verticale spindel, tevens dient u de veiligheid van de bediener in acht te nemen.

Order nr.	790008859 M	790008860 M	790008864 M	790008865 M
Orig. nr.	PFR 02/625/DX	PFR 02/625/SX	PFR 02/730/DX	PFR 02/730/SX
A	mm 620	620	725	725
B	mm 250	250	300	300
C	mm 170	170	200	200
D	mm 405	405	430	430
Zijde	Rechts	Links	Rechts	Links
Prijs	€ 785,00	779,00	815,00	815,00

METALWORKS



Veiligheidsafscherming voor grote kolom- en radiaal boormachines.

Derde generatie veiligheidsafscherming voor boormachines "Made in EU", verticale afstelling van het scherm met telescopisch arm systeem. Geschikt om te gebruiken voor grote kolom- en radiaal boormachines.

Dikwandig polycarbonaat scherm. Voorzien van een microschakelaar n.2 NC contacten, is een positief contact zoals omschreven in EN 60947-5-1. Iedere afscherming draagt het CE kenmerk en wordt bovendien geleverd met een eigen CE certificaat.

Beschermt de bediener tegen direct contact met de draaiende delen en spanen en tegen wegsplattend smeer - koelmiddel.

Opgepast: een dergelijke booraafscherming vergt telkens aanpassingen om op uw grote kolom boormachine of radiaal boormachine te monteren. Een veiligheidsafscherming dient geplaatst te worden door gekwalificeerd personeel. De geschatte werktijd bedraagt ongeveer 2 werkuren, mits er een noodstopcircuit aanwezig is. Bij vragen of plaatsing, kunt u altijd onze technische dienst contacteren.

Bij uw keuze van afscherming dient u rekening te houden met de boordiepte, alsook de breedte van de spil, die dient afgeschermd te worden, tevens dient u de veiligheid van de bediener in acht te nemen.

Order nr.	790008794 M	790008796 M
Orig. nr.	PTR 20/300	PTR 20/350
A	mm 300	350
B	mm 200	240
C	mm 150	175
Prijs	€ 389,00	399,00

Voor draaibanken

METALWORKS

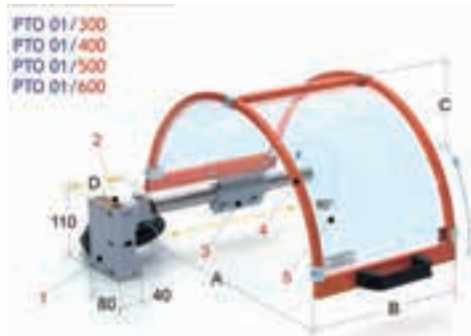

Veiligheidsafscherming voor klauwplaat.

Derde generatie veiligheidsafscherming voor klauwplaten "Made in EU", uitgerust met een stalen frame. De enige, die tot bij de machinekop kan gepositioneerd worden.

Thermogevormd scherm in schokbestendig en olie resistent materiaal. Voorzien van een microschakelaar n.2 NC contacten, is een positief contact zoals omschreven in EN 60947-5-1. Iedere afscherming draagt het CE kenmerk en wordt bovendien geleverd met een eigen CE certificaat.

Beschermt de bediener tegen direct contact met het bovenste deel van de klauwplaat en tegen wegs pattend smeermiddel – koelvloeistof.

Opgepast: een klauwplaat afscherming vergt telkens aanpassingen om op uw draaibank te monteren. Een veiligheidsafscherming dient geplaatst te worden door gekwalificeerd personeel. De geschatte werktijd bedraagt ongeveer 2 werkuren, mits er een noodstopcircuit aanwezig is. Bij vragen of plaatsing, kunt u altijd onze technische dienst contacteren.

Bij uw keuze van grootte van klauwplaat afscherming dient u rekening te houden met de draaidiameter boven het bed, tevens dient u de veiligheid van de bediener in acht te nemen.

Order nr.	790008801 M	790008804 M	790008807 M
Orig. nr.	PTO 01/400	PTO 01/500	PTO 01/600
A	mm 400	500	600
B	mm 235	235	235
C	mm 230	280	330
D	mm 0-150	0-150	0-150
Prijs	€ 339,00	345,00	360,00

METALWORKS

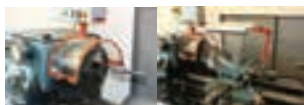
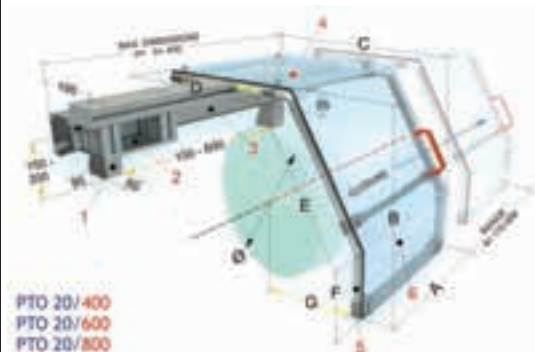

Glijdende veiligheidsafscherming.

Derde generatie veiligheidsafscherming voor klauwplaten "Made in EU".

Beschermt de bediener tegen direct contact met draaiende delen van de klauwplaat en wegschietende spanen en tegen wegs pattend smeermiddel – koelvloeistof.

Wordt bevestigd op de kop van de draaibank, uitgerust met een breed, goed zichtbaar, glijdende scherm, met verschillende afstel mogelijkheden voor een eenvoudige aanpassing op alle draaibanken.

In schokbestendig en olie resistent materiaal. Voorzien van een microschakelaar n.2 NC contacten, is een positief contact zoals omschreven in EN 60947-5-1. Iedere afscherming draagt het CE kenmerk en wordt bovendien geleverd met een eigen CE certificaat.

Beschikbaar in 3 afmetingen, voor klauwplaten tot een diameter van 800-900 mm. Compleet met microschakelaar.

Opgepast: een glijdende veiligheidsafscherming vergt telkens aanpassingen om op uw draaibank te monteren. Een veiligheidsafscherming dient geplaatst te worden door gekwalificeerd personeel. De geschatte werktijd bedraagt ongeveer 4 werkuren, mits er een noodstopcircuit aanwezig is. Bij vragen of plaatsing, kunt u altijd onze technische dienst contacteren.

Bij uw keuze van grootte klauwplaat afscherming dient u rekening te houden met de draaidiameter boven het bed, tevens dient u de veiligheid van de bediener in acht te nemen.

Order nr.	790008828 M	790008829 M	790008830 M
Orig. nr.	PTO 20/400	PTO 20/600	PTO 20/800
A	mm 450	450	450
B	mm 430	520	640
C	mm 655	855	1065
D	mm 480	640	800
E	mm 350	430	530
F	mm 125	150	180
G	mm 280-540	320-740	370-950
Diameter	mm 400-500	600-700	800-900
Prijs	€ 1.249,00	1.299,00	1.375,00



METALWORKS

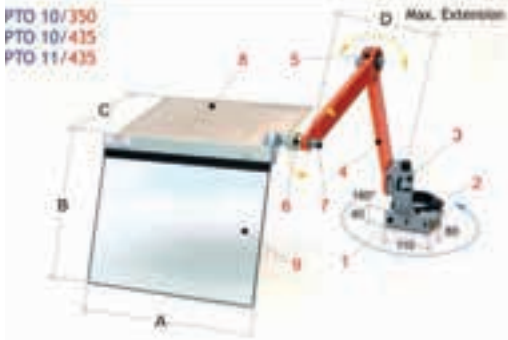

Veiligheidsafscherming voor beitelhoeder.

Derde generatie veiligheidsafscherming voor beitelhoeder "Made in EU", specifiek multi verstelbare afscherming, voor op de wagen van een draaibank. Gecombineerd met de veiligheidsafscherming voor de klauwplaat, biedt dit een uitzonderlijke bescherming aan van de bediener.

Thermogevormd scherm in schokbestendig en olie resistent materiaal. Voorzien van een microschemelaar n.2 NC contacten, is een positief contact zoals omschreven in EN 60947-5-1. Iedere afscherming draagt het CE kenmerk en wordt bovendien geleverd met een eigen CE certificaat.

Beschermt de bediener tegen direct contact met draaiende delen van de klauwplaat en wegschietende spanen en tegen wegsputtend smeermiddel – koelvloeistof.

Wordt bevestigd aan de achterzijde van de wagen. Het scherm, ondersteunt door de gelede armen dankzij een kogelgewricht, is volledig regelbaar en beschermt tegen spanen. Schermen kunnen afzonderlijke aangekocht worden.

Opgepast: een beitelhoeder afscherming vergt telkens aanpassingen om op uw draaibank te monteren. Een veiligheidsafscherming dient geplaatst te worden door gekwalificeerd personeel. De geschatte werktijd bedraagt ongeveer 3 werkuren, mits er een noodstopcircuit aanwezig is. Bij vragen of plaatsing, kunt u altijd onze technische dienst contacteren.

Bij uw keuze van grootte van beitelhoeder afscherming dient u rekening te houden met de afmetingen de bevestigingsbeugel om deze te kunnen monteren op de wagen, tevens dient u de veiligheid van de bediener in acht te nemen.

Order nr.	790008823 M	790008825 M	790008826 M
Orig. nr.	PTO 10/350	PTO 10/435	PTO 11/435
A	mm 350	400	400
B	mm 300	350	350
C	mm 280	310	310
D	mm 550	550	800
Prijs	€ 449,00	452,00	559,00

METALWORKS



Veiligheidsafscherming voor leispil en voedingsgas.

Derde generatie veiligheidsafscherming voor leispil en voedingsgas "Made in EU", bestaat uit twee eenheden van zelfoprollende rollen, vervaardigd met scheur- en oliebestendige draad. Gecombineerd met de veiligheidsafscherming voor de klauwplaat en beitelaafscherming, biedt dit een optimale bescherming aan van de bediener.

Ontworpen om frontaal te bevestigen voor de moerwijs en de voedingsassen van een draaibank. Uit twee delen die worden bevestigd aan de twee uiteinden van de wagen, uitgerust met zelfgeleidende rollen, worden bediend door de meervoudige veren binnenin. De beschermende band is geproduceerd uit sterk textiel en is resistent tegen koelvloeistoffen en scheuren. Iedere eenheid is specifiek ontworpen voor zijn kant van de wagen en voorzien van geschikte bevestigingsbeugels. Tijdens het verplaatsen van de wagen, worden de twee eenheden vanzelf op- en afgerold, en beschermen ze zo constant de bediener tegen eventueel vastlopende werkkledij.

Opgepast: een dergelijke veiligheidsafscherming vergt telkens aanpassingen om op uw draaibank te monteren. Een veiligheidsafscherming dient geplaatst te worden door gekwalificeerd personeel. De geschatte werktijd bedraagt ongeveer 2 werkuren. Bij vragen of plaatsing, kunt u altijd onze technische dienst contacteren.

Bij uw keuze van afscherming dient u rekening te houden met de hoogte, die dient afgeschermd te worden van leispil en voedingsgas, en centerlengte van uw draaibank, tevens dient u de veiligheid van de bediener in acht te nemen.

Order nr.	790008835 M	790008836 M	790008837 M	790008838 M
Orig. nr.	PAT 01/120	PAT 01/150	PAT 01/200	PAT 01/300
A	mm 1200	1500	2000	3000
B	mm 150	200	200	250
Prijs	€ 615,00	635,00	875,00	1.155,00

Boorhouders

OPTIMUM



Verloopadaptor voor UNF 3/8x24 boorhouders in UNF 1/2x20 machines.

Order nr.	749551102 M
Adaptor	3/8" naar 1/2"
Prijs	€ 6,90

METALWORKS



Uitdrijfspie.

- Uitdrijfspieën worden gebruikt om eenvoudig morse konus gereedschappen te verwijderen uit de spindel.
- Universeel model - DIN317 - zwarte, geharde uitvoering (zonder handgreep)
- Halfautomatisch model - DIN318 - door het handvat kan een hefboom effect gecreërd worden, waardoor het eenvoudiger wordt een boor uit de spindel te drijven.

Order nr.	891020430 M	713050636 M	713050637 M
Voor type	Universeel model	Voor MK1-MK3	Voor MK4-MK6
Prijs	€ 6,90	17,90	23,50

METALWORKS



Industriële kwaliteit. Tandkrans boorhouder. Met sleutel. 3 bekken. Bekken zijn gehard en geslepen. Met hoge spankracht. Links-rechtsdraaiend. Voor gebruik op klopboormachines, boormachines, draaibanken en houtbewerkingsmachines.

Order nr.	Voor type	Aansluiting	Capaciteit	Spilopname	Sleuteltype	Prijs
			mm			€
200850600 M	MB351-502E		1/2"x20,13	1/2"x20		6,60
742201203 M		B12	1.5-13		KS2	7,30
200820207 M		B16	1.5-13		KS2	17,50
742202011 M		B22	5-20		KS4	164,00

METALWORKS



Sleutels voor boorhouder met tandkrans.

Order nr.	Sleuteltype	Diameter top	Aantal tanden	Prijs
		mm		€
03691755 M	KS10	8	12	10,50
03691458 M	KH810	6	11	2,90
200830404 M	KS2	6	12	2,90
200830503 M	KS3	8	12	4,25

METALWORKS



Boorhouder. Industriële kwaliteit. Zelfspannende boorhouder voor gebruik met klopboormachines. 3 bekken. Types met aansluiting 1/2"x20 en 3/8"x24, zijn links-rechtsdraaiend.

Order nr.	Aansluiting	Capaciteit	Maximum vermogen machine	Prijs
		mm	Watt	€
749651607 M	3/8"x24	2-13	710	13,50
749651001 M	1/2"x20	1.5-10	450	11,00
749651708 M	B12	1.5-13	710	46,50
749651203 M	3/8"x24	1.5-10	450	11,00
749651506 M	1/2"x20	2-13	710	13,50

OPTIMUM



Snelspan boorkoppen. Industriële kwaliteit. Zelfspannende boorhouder. 3 bekken. Snelklemming en zelfklemmend. Met kogellager. De bekken zijn gehard en geslepen. Voor montage op boormachines, freesmachines en draaibanken. Opname van de boorkop volgens DIN238. Kegeldoorn niet inbegrepen.

Order nr.	Aansluiting	Capaciteit	Merk	Prijs
		mm		€
713050608 M	B16	0-8	Optimum	34,90
713050610 M	B16	0-10	Optimum	35,00
713050623 M	B16	0-13	Optimum	35,90
713050626 M	B16	0-16	Optimum	41,90
713050630 M	B18	0-16	Optimum	41,50
749661910 M	1/2"x20	3-16	Metalworks	69,00
713050656 M	B16	1-13	Rohm	45,90
713050657 M	B16	3-16	Rohm	50,00

OPTIMUM



Snelspan boorkop met geïntegreerde kegeldoorn. Essentieel te gebruiken bij aankoop van tafel- of kolomboormachine met variabele spijlsnelheden. Deze kunnen door hun monoblok uitvoering hogere snelheden aan. Ook voor draaibanken is dit ideaal door de hogere rondlooppauwkeurigheid van 0.05 mm.

Order nr.	Aansluiting	Capaciteit	Prijs
		mm	€
713050572 M	MK2	0,3-13; tot 8000 tpm	78,00
713050571 M	MK2	0,3-16; tot 6'000 tpm	89,00
713050585 M	MK3	0,3-13; tot 8'000 tpm	106,00
713050573 M	MK3	0,3-16; tot 8'000 tpm	89,00
713050574 M	MK4	0,3-16; tot 6'000 tpm	89,00

KEGELDOORNS

Verschillende kegeldoorns voor het opnemen van boorkoppen in uw machine. Dit is van essentieel belang bij aankoop van een boorkop. Kegeldoorns met draadopname voor boorfreesmachines. Kegeldoorns met ISO konus DIN2080 voor freesmachines. Kegeldoorns met morse konus opname DIN228 voor boormachines. Gehard en geslepen.

METALWORKS



MK

Kegeldoorns met morse konus MK opname DIN228 voor boormachines en draaibanken. Gehard en geslepen. Deze kegeldoorns kunnen gebruikt worden op alle boormachines, zoals B16, B23PRO, B28H, etc.

Opgepast: eerst nazien met welke spindel uw machine is uitgerust en dan de geschikte kegeldoorn uitkiezen.

Kegeldoorns met draadopname voor boorfreesmachines. Kegeldoorns met ISO konus DIN2080 voor freesmachines.

790023079 ingekorte versie MK1 voor gebruik bij TU1503V

Order nr.	Aansluiting MK	Boorkopkant	Prijs €
713050658	1	B16	4,60
790023079	1	B16	10,50
713050659	2	B16	4,60
749642018	2	B18	4,10
713050660	3	B16	5,70
749643018	3	B18	4,90
713050661	4	B16	9,10
749644018	4	B18	7,20
749644022	4	B22	11,50
713050675	5	B16	11,50
713050676	6	B16	20,50

METALWORKS



MK/M

Kegeldoorns Morse konus met langs de machinezijde draadopname, volgens DIN228 - vorm A. Gehard en geslepen.

Deze kegeldoorns kunnen gebruikt worden op alle boorfreesmachines, zoals BF20, BF30 MK3, F40E, MB4/P.

Opgepast: eerst nazien met welke spindel uw machine is uitgerust en dan de geschikte kegeldoorn uitkiezen.

Kegeldoorns met ISO konus DIN2080 voor freesmachines. Kegeldoorns met morse konus opname DIN228 voor boormachines en draaibanken.

Order nr.	713050670	713050669	790023034
Aansluiting	MK	3/M12	4/M16
Boorkopkant	B16	B16	B16
Prijs	€ 5,10	6,10	7,10

METALWORKS

MK



Reductiehulzen DIN2185. Geslepen en gehard. Voor gebruik in boormachines en tegenpunt van draaibanken.

Order nr.	Uitwendig MK	Inwendig MK	Prijs €
749601021	2	1	4,10
749601031	3	1	6,50
713050663	3	2	4,90
713050665	4	2	6,50
713050664	4	3	6,90
749601052	5	2	13,00
749601053	5	3	13,50
749601054	5	4	13,50

METALWORKS



MK/M

Reductiehuls Morse konus DIN 2186 met langs de machinezijde draadopname. Geslepen en gehard. Voor gebruik in boorfreesmachines:

MK3/M12: B40BE, MH28V, F40E, BF30 MK3/M12

MK4/M16: B40E, B40PTE, BF46 MK4/M16, MB4/P.

Order nr.	Uitwendig	Inwendig	Prijs €
790024032	MK3/M12	MK2	6,20
790023035	MK4/M16	MK1	7,20
790023036	MK4/M16	MK2	7,20
790023037	MK4/M16	MK3	7,20
790023038	MK4/M16	MK4	27,50

METALWORKS

MK



Verleng- en vergroothuls DIN2187. Geslepen en gehard. Een vergroothuls wordt gebruikt als uw morse konus boor een groter nummer van konus heeft, dan de spilconus van uw boormachine of tegenpunt van uw draaibank. Verlenghuls wordt gebruikt om uw spilconus van uw machine te verlengen.

Let wel : hou rekening met het vermogen van uw boormachine en draaibank.

Order nr.	Uitwendig MK	Inwendig MK	Totale lengte mm	Prijs €
749611012	1	2	160	8,90
749611021	2	2	175	9,80
713050667	2	3	196	20,50
749611042	2	4	221	14,50
749611033	3	3	215	12,50
713050668	3	4	240	30,90
749611053	3	5	275	21,50
749611044	4	4	265	19,50
749611054	4	5	300	28,50

Klem -& opspangereedschap

METALWORKS



MK

Adapter voor kernboren met Weldon 19 mm opname. Modellen met en zonder koeling geschikt voor kernboormachines. Zonder koeling kunnen eveneens worden ingezet op tafelen kolomboormachines.

Order nr.	Type	Inwendige diameter	Uitwendige diameter	Prijs
	MK	cm	cm	€
748255070 ^M	2	2	4	47,00
748255071 ^M	2 met koeling	2	4	96,00
748255072 ^M	3 met koeling	2	4	101,00
748255073 ^M	3	2	4	53,00

METALWORKS



ISO

Kegeldoorns ISO konus DIN2080, volgens DIN238. Gehard en geslepen. Deze kegeldoorns kunnen gebruikt worden alle freesmachines en sommige boorfreesmachines, zoals BF30 ISO30, BF46, MF2, MF4, MT50, MT100, MT200, MX-serie, etc.

Opgepast : eerst nazien met welke spindel uw machine is uitgerust en dan de geschikte kegeldoorn uitkiezen.

Kegeldoorns met draadopname voor boor-freesmachines. Kegeldoorns met morse konus opname DIN228 voor boormachines en draaibanken.

Order nr.	713352069 ^M	713352070 ^M	790024004 ^M
Aansluiting	ISO 30/M12	40/M16	50/M22
Boorkopkant	B16	B16	B16
Prijs	€ 29,90	30,00	41,50

METALWORKS



ISO

Reductiehuls DIN6383 volgens ISO konus DIN2080. Geslepen en gehard. Voor het opnemen van morse konus boren in boorfreesmachines en freesmachines.

Order nr.	Uitwendig ISO	Inwendig MK	Prijs €
790002952 ^M	30	2	36,00
790002953 ^M	30	3	36,00
790002955 ^M	40	2	40,50
790002956 ^M	40	3	40,50
790002957 ^M	40	4	40,50
790002958 ^M	50	2	52,00
790002959 ^M	50	3	47,00
790002960 ^M	50	4	46,50
790002961 ^M	50	5	52,00

Freeshouders

METALWORKS

MK/M



Vlakfrees opnamehouders met MK met draadopname. Voor het opnemen van vlakfreesen en mantelkopfreesen van alle gekende merken met een as gat van 16 tot 27 mm. Andere maten op aanvraag.

Order nr.	Aansluiting	Boring vlakfrees d	Breedte mm	Prijs €
	MK	d	mm	€
713352102 ^M	2/10	16	8	56,50
790007230 ^M	2/10	22	10	41,50
790007231 ^M	2/10	27	12	41,50
790007232 ^M	3/12	22	10	44,50
790002949 ^M	3/12	27	12	44,50
713350456 ^M	3/12	32	12	58,50

OPTIMUM



ISO

Vlakfrees opnamehouders met ISO DIN2080 opname. Voor het opnemen van vlakfreesen en mantelkopfreesen van alle gekende merken met een as gat van 22 tot 32 mm. Andere maten op aanvraag.

Order nr.	Aansluiting	Boring vlakfrees d	Breedte mm	Lengte mm	Prijs €
	ISO	d	mm	mm	€
790002934 ^M	30	22	10	129	40,90
790002935 ^M	30	27	12	134	48,50
790002936 ^M	30	32	14	141	48,50
790002937 ^M	40	22	10	156	48,50
790002938 ^M	40	27	12	159	60,50
790002939 ^M	40	32	14	178	60,50

SPANTANGEN ER DIN6499

ER spantangen. ER spantangen zijn gemaakt van speciaal elastisch staal 65Mn en zijn geproduceerd volgens DIN6499, ze hebben een precisie nauwkeurigheid van 0.015 en een sterke klemmingskracht. Hardheid van HRC44-48. ER25, ER32 en ER40. Standaard precisie, A klasse op aanvraag.

ER spantangen afmetingen:

	D H7	D	D1	D2	L	L1	L2	L3	Cap.
	mm	mm	mm	mm	mm	mm	mm	mm	kg
ER25	1,0 - 2,5	25	26	22	34	6,66	5	3,1	0,5
	2,5 - 16,0	25	26	22	34	6,66	5	3,1	1
ER32	2,0 - 2,5	32	33	29,2	40	7,16	5,5	3,6	0,5
	2,5 - 20	32	33	29,2	40	7,16	5,5	3,6	1
ER40	3,0 - 26,0	40	41	36,2	46	7,66	7	4,1	1

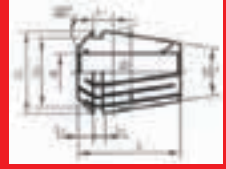

METALWORKS



MK/M

Set bestaande uit directspannende spantangen. Set bestaande uit spannende spantangen, zonder gebruik van spanhouder. Met MK2/M10 of MK3/M12 opname. Spantangen zijn eveneens apart leverbaar.

Order nr.	Aantal stuks	Aansluiting	Maten	D		Prijs €
				mm	mm	
713351980	5	MK	4 - 6 - 8 - 10 - 12	18	68	51,90
713352014	6	3/M12	4 - 6 - 8 - 10 - 12 - 16	24,1	86	59,90

METALWORKS



MK/M

ISO

Set bestaande uit 1 spantang houder, 1 haaksleutel en meerdere individuele ER spantangen DIN6499. Diverse opnames van de spantang houder mogelijk: MK2/M10, MK3/M12, DIN2080 ISO30, DIN2080 ISO40. Ook kan er een keuze gemaakt worden uit verschillende soorten ER spantangen ER25, ER32 en ER40. Andere sets mogelijk op aanvraag.

Order nr.	Aansluiting	ER DIN6499	Aantal	Maat spantangen mm	Prijs €
713352052	MK2/M10	ER25	6	4 - 6 - 8 - 10 - 12 - 16	129,00
713352053	MK2/M10	ER32	6	6 - 8 - 10 - 12 - 16 - 20	139,00
790002076	MK3/M12	ER32	6	6 - 8 - 10 - 12 - 16 - 20	149,00
790002085	MK4/M16	ER40	7	4 - 6 - 8 - 10 - 12 - 16 - 20	159,00
713352054	ISO30	ER32	6	6 - 8 - 10 - 12 - 16 - 20	149,00
713352055	ISO40	ER32	7	4 - 6 - 8 - 10 - 12 - 16 - 20	159,00
790002019	ISO40	ER40	7	4 - 6 - 8 - 10 - 16 - 20 - 25	169,00

METALWORKS



MK/M

ISO

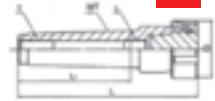

Afzonderlijke spantangenhouders voor spantangen ER DIN6499. Diverse opnames van de spantang houder mogelijk: MK2/M10, MK3/M12, DIN2080 ISO30, DIN2080 ISO40. Ook kan er een keuze gemaakt worden uit verschillende soorten ER spantangen ER25, ER32 en ER40. Andere houders op aanvraag.

Order nr.	Aansluiting	Voor spantang	L mm	L1 mm	D mm	Prijs €
						€
790002051	MK2/M10	ER25	119	64	42	30,90
790002052	MK2/M10	ER32	129	64	50	47,50
790002053	MK3/M12	ER32	156	81	50	47,50
790002058	MK4/M16	ER40	177,5	102,5	63	55,50
790001998	ISO30	ER32	128,4	60	50	33,90
790002000	ISO40	ER32	153,4	60	50	41,50
790002001	ISO40	ER40	163,4	70	63	41,50
790002003	ISO50	ER32	70	50	50	59,90
790002004	ISO50	ER40	70	63	63	59,90

METALWORKS



Set ER spantangen. Sets ER spantangen zijn gemaakt van speciaal elastisch staal 65Mn en zijn geproduceerd volgens DIN6499, ze hebben een precisie nauwkeurigheid van 0.015 en een sterke klemmingskracht. Hardheid van HRC44-48. ER25, ER32 en ER40. Precisie, A klasse.

Order nr.	713441109	713441122	790007210
Aantal stuks	15	18	23
Maat spantangen mm	2-3-4-5-6-7-8-9-10-11-12-13-14-15-16	3-4-5-6-7-8-9-10-11-12-13-14-15-16-17-18-19-20	4-5-6-7-8-9-10-11-12-13-14-15-16-17-18-19-20-21-22-23-24-25-26
Type spantangen	ER25	ER32	ER40
Prijs €	139,00	179,00	189,00

SPANTANGEN ER DIN6499

ER spantangen. ER spantangen zijn gemaakt van speciaal elastisch staal 65Mn en zijn geproduceerd volgens DIN6499, ze hebben een precisie nauwkeurigheid van 0.015 en een sterke klemmingskracht. Hardheid van HRC44-48. ER25, ER32 en ER40. Standaard precisie, A klasse op aanvraag.

ER spantangen afmetingen:

	D H7	D	D1	D2	L	L1	L2	L3	Cap.
	mm	mm	mm	mm	mm	mm	mm	mm	kg
ER25	1,0 - 2,5	25	26	22	34	6,66	5	3,1	0,5
	2,5 - 16,0	25	26	22	34	6,66	5	3,1	1
ER32	2,0 - 2,5	32	33	29,2	40	7,16	5,5	3,6	0,5
	2,5 - 20	32	33	29,2	40	7,16	5,5	3,6	1
ER40	3,0 - 26,0	40	41	36,2	46	7,66	7	4,1	1

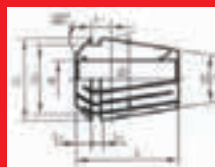

METALWORKS



ER25 losse spantangen, volgens DIN6499. ER25 heeft een bereik tussen de 2 en 16 mm. Verkrijgbaar per mm.

Order nr.	Orig. nr.	Diameter mm	Prijs €
790001705 M	ER2502	2-1	5,40
790001706 M	ER2503	3-2	5,40
790001707 M	ER2504	4-3	5,40
790001708 M	ER2505	5-4	5,40
790001709 M	ER2506	6-5	5,40
790001710 M	ER2507	7-6	5,40
790001711 M	ER2508	8-7	5,40
790001712 M	ER2509	9-8	5,40
790001713 M	ER2510	10-9	5,40
790001714 M	ER2511	11-10	5,40
790001715 M	ER2512	12-11	5,40
790001716 M	ER2513	13-12	5,40
790001717 M	ER2514	14-13	5,40
790001718 M	ER2515	15-14	5,40
790001719 M	ER2516	16-15	5,40

METALWORKS



ER40 losse spantangen, volgens DIN6499. ER40 heeft een bereik tussen de 3 en 26 mm. Verkrijgbaar per mm.

Order nr.	Type	Diameter mm	Prijs €
790001738 M	ER40	3-2	6,90
790001739 M	ER40	4-3	6,90
790001740 M	ER40	5-4	6,90
790001741 M	ER40	6-5	6,90
790001742 M	ER40	7-6	6,90
790001743 M	ER40	8-7	6,90
790001744 M	ER40	9-8	6,90
790001745 M	ER40	10	6,90
790001746 M	ER40	11-10	6,90
790001747 M	ER40	12-11	6,90
790001748 M	ER40	13-12	6,90
790001749 M	ER40	14-13	6,90
790001750 M	ER40	15-14	6,90
790001751 M	ER40	16-15	6,90
790001752 M	ER40	17-16	6,90
790001753 M	ER40	18-17	6,90
790001754 M	ER40	19-18	6,90
790001755 M	ER40	20-19	6,90
790001756 M	ER40	21-20	6,90
790001757 M	ER40	22-21	6,90
790001758 M	ER40	23-22	6,90
790001759 M	ER40	24-23	6,90
790001760 M	ER40	25-24	6,90
790001761 M	ER40	26-25	6,90

METALWORKS



ER32 losse spantangen, volgens DIN6499. ER32 heeft een bereik tussen de 3 en 20 mm. Verkrijgbaar per mm.

Order nr.	Type	Diameter mm	Prijs €
790001720 M	ER32	3-2	5,90
790001721 M	ER32	4-3	5,90
790001722 M	ER32	5-4	5,90
790001723 M	ER32	6-5	5,90
790001724 M	ER32	7-6	5,90
790001725 M	ER32	8-7	5,90
790001726 M	ER32	9-8	5,90
790001727 M	ER32	10-9	5,90
790001728 M	ER32	11-10	5,90
790001730 M	ER32	13-12	5,90
790001734 M	ER32	17-16	5,90
790001733 M	ER32	16-15	5,90
790001731 M	ER32	14-13	5,90
790001729 M	ER32	12-11	5,90
790001732 M	ER32	15-14	5,90
790001735 M	ER32	18-17	5,90
790001736 M	ER32	19-18	5,90
790001737 M	ER32	20-19	5,90

METALWORKS



Aparte haakse sleutel ER DIN 6499 voor het opspannen van uw ER spantangen in hun respectievelijke spantanghouder, ER25, ER32 en ER40.

Order nr.	790007227 M	790007228 M	790023039 M
Orig. nr.	790007227	790007228	790023039
Opspancapaciteit	38-42	45-52	55-62
Voor spantang	ER25	ER32	ER40
Gewicht	kg 0,10	0,15	0,10
Prijs	€ 6,10	6,70	7,20

Machineuitrusting

METALWORKS



Universele beschermingslat voor T-gleuven. Beschermt uw T-gleuven en bespaart tijd bij het reinigen van de T-gleuven. Minder spanen in de koelmelk. Vervaardigd in geanodiseerd aluminium.

Order nr.	Aantal stuks	T-gleuf mm	Lengte mm	Voor machine	Prijs €
790000593 ^M	6	10	300	BF16	36,00
790000594 ^M	6	12	400	BF20-BF20L-BF30-F40E	35,90
790000595 ^M	6	14	400	UF100	35,90
790000596 ^M	6	16	400	F30-F45-MF2-MF4	41,00
790000597 ^M	6	18	450	BF46 Vario	40,50

OPTIMUM



Automatische voeding voor de X-as van de BF20.

- traploos regelbare snelheid -set eindeloopschakelaars
- links/rechts draaiend
- noodstop functie
- ingebouwde koelribben
- aandrijving via een stappenmotor zonder CNC controller
- te gebruiken in combinatie met 713570015

Indien u dit artikel op een nieuwe boorfreemACHINE wil laten installeren, vergeet dan uw 2 werken niet op te geven.

Order nr.	713571941 ^M
Prijs €	289,00

OPTIMUM



Montageset X-as MK F20X. Bestaande uit :

- stappenmotor
- behuizing incl. deksel
- aandrijfriempjes
- 2 riemenschijven
- montagering
- elektrische kabel
- schroevenset
- te gebruiken in combinatie met 713571941

Order nr.	713570015 ^M
Prijs €	245,00

OPTIMUM



Universele voedingsmotor voor de langsrichting (X as) voor boor-freesmachines, zoals BF30, BF46 en F40E. Horizontale montage. Met traploze regeling van het toerental en ijlgang. Rechts-links lopend. Transformator, overbelastingsbeveiliging en eindeloopschakelaar. Voor zelfmontage.

Vergeet uw bijhorende montageset voor BF30 / F40E niet bij te bestellen 713352035, alsook de montageset niet voor de BF46 - 713352036.

Indien u dit artikel op een nieuwe boorfreemACHINE wil laten installeren, vergeet dan uw 2 werken niet op te geven.

Order nr.	713352022 ^M
Type	V 99
Voor type	BF30 / BF46 / F40E
Snelheid tpm	0 - 165
Ijlgang tpm	240
Prijs €	399,00

OPTIMUM



Montageset voor V99. Voor monteren automatische voeding X-as op BF30, F40E en BF46.

Order nr.	713352035 ^M	713352036 ^M
Voor type	BF30 - F40E	BF46
Prijs €	71,50	79,00

OPTIMUM



Universele voedingsmotor voor de langsrichting (X as) en dwarsrichting (Y as) voor de meeste torenfreemachines, zoals MF2 en MF4. Met traploze regeling van het toerental en ijlgang. Rechts-links lopend. Transformator, overbelastingsbeveiliging en eindeloopschakelaar. Voor zelfmontage.

Indien u dit artikel op een nieuwe freemACHINE wil laten installeren, vergeet dan uw 2 werken niet op te geven.

Order nr.	713352029 ^M	713352025 ^M
Type	V 250 X as	V 250 Y as
Voor type	MF2 / MF4	MF2 / MF4
Snelheid tpm	5 - 160	5 - 160
Ijlgang tpm	200	200
Prijs €	529,00	469,00

METALWORKS



Pneumatische gereedschapsaantrekker DIN2080. ISO40. Hoog bereikbaar vacuüm, korte wisseltijden door bediening met één hand. Gering gewicht door geoptimaliseerde structuur. Veilige vergrendeling door het principe van de kniehefboom. Preciese geleiding door geoptimaliseerde geometrie. Gering luchtverbruik, lichte bouw, gemakkelijke aansluiting. Niet gemonteerd. Standaard uitrusting: motor, aantrekstang, lucht en olieliter en stuurkast.

Order nr.	713352393 M	713352394 M	790000511 M
Konus	ISO30 DIN2080	ISO40 DIN2080	ISO50 DIN2080
Snelheid	tpm 3000	3000	3000
Luchtdrukverbruik	psi 90	90	90
Klemkracht	kg/cm² 6,3	6,3	6,3
Spanning	V 220V DC24V	220V DC24V	220V DC24V
Prijs	€ 719,00	720,00	949,00

METALWORKS



Universele trillingsdemper. Verankeringvrij - trillingsisolerend. Maakt een eenvoudig waterpas zetten van de machine mogelijk. Voor draaibanken, freesmachines, slijpmachines, compressoren, machines in het algemeen.

Order nr.	713381012 M	713381016 M	713381018 M
Schroefdraad	M 12	16	20
Maximum toelaatbare belasting	kg 570	1500	3500
Diameter voet	mm 120	160	185
Hoogte voet	mm 32	35	39
Capaciteit	340kg (freesmachines) - 570kg (zaagmachines, alle machines)	460kg (freesmachines) - 1460kg (zaagmachines, alle machines)	1600kg (freesmachines) - 3500kg (zaagmachines, alle machines)
Prijs	€ 34,00	30,90	42,90

Metalwerk



Magnetisch apparaat voor het opnemen van spanen. Het CHIPMAG spaanopname-apparaat neemt moeiteloos alle spanen magnetisch op, ook in de meest ontoegankelijke plaatsen. De opname van de spanen gebeurt door de magnetische oppervlakte, het verwijderen van de spanen gebeurt door het eenvoudig demagnetiseren door de hendel in te drukken. Een uitstekend instrument dat bij geen enkele zaagmachine mag ontbreken.

Order nr.	713850010 M
Orig. nr.	ZYKLON
Prijs	€ 42,90

Opspangereedschap draaibank

OPTIMUM



Afstekbeitelhouder CB1 voor afstekmessen CH1. Zonder SWH op draaibanken van D420 en met SWH op draaibanken van D320. Complete beitelhouder, zonder mes en plaatjes.

Order nr.	713440680 M
Voor type	CH1
Prijs	€ 59,00

OPTIMUM



Afstekmes CH1 voor afstekbeitelhouder CB1. Tot 75 mm. Inclusief wisselplaten.

Order nr.	713440685 M
Voor type	CB1
Prijs	€ 63,00

OPTIMUM



Wisselplaten ACH1 voor afstekmessen CH1 te gebruiken in een afstekbeitelhouder CB1.

Order nr.	713440686 M
Voor type	CH1 en CB1
Prijs	€ 116,00

OPTIMUM



ER spantangen klauwplaat passend op draaibanken zoals Optimum. Met ofwel kortkegel opname ofwel cilindrische opname.

Order nr.	Voor type	Aansluiting	ER spantang	Prijs €
713440281 M	TU1503V	Kortkegel	ER16	56,50
713441305 M	TU2506 / TU2807	Kortkegel	ER25	90,00
713440305 M	TU2004V	Cilindrisch	ER25	72,50
713440505 M	TU2404 TU2406 TU2304	Cilindrisch	ER25	80,00
713441306 M	TU2506 TU2807	Kortkegel	ER32	109,00
713440506 M	TU2404 TU2406	Cilindrisch	ER32	90,00



OPTIMUM



NEW

5C spantangen klauwplaat passend op draaibanken zoals Optimum. Met opname Camlock DIN55029 (DIN ISO 702-2). Rondloopnauwkeurigheid 0.02 mm. 5C spantangen niet inbegrepen zie 713441509.

Order nr.	713441554	713441556	713441558	
Aansluiting	Camlock	D1-4"	D1-6"	D1-8"
Voor type	D320	D420/D460	D560/D660	
Prijs	€ 569,00	625,00	669,00	

OPTIMUM



Spantangenset 5C.
 - Voor universele spantang inrichtingen
 - Te gebruiken bij 713441554, 713441556 en 713441558
 - Norm 385 E
 - 17 delig met een spanbereik van 3 - 25 mm.

Order nr.	713441509
Prijs	€ 309,00

OPTIMUM

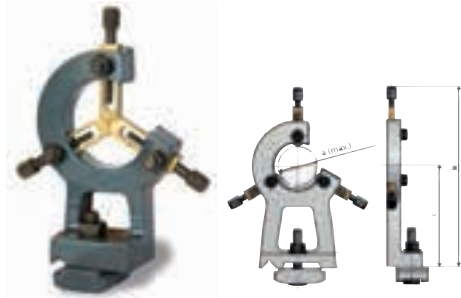

Vaste bril. Als een as erg lang is voor de draaibank en ook vrij zwaar, gebruiken we een vaste bril om de as te ondersteunen.

Order nr.	713440211	713440231	713440361
Voor type	TU1503V	TU2004V	TU2304V
Maximum buisdiameter (a)	mm 40	50	50
Totale hoogte (b)	mm 145	200	245
Centerhoogte (c)	mm 70,5	100	125
Prijs	€ 22,90	37,90	51,90

Order nr.	713441315	713441415
Voor type	D240	D280
Maximum buisdiameter (a)	mm 50	55
Totale hoogte (b)	mm 245	250
Centerhoogte (c)	mm 125	140
Prijs	€ 52,00	65,00

OPTIMUM

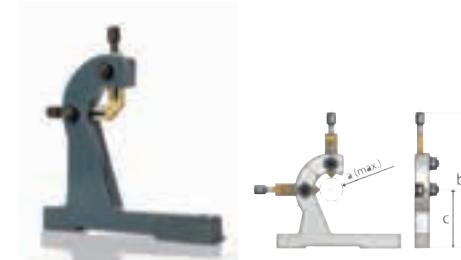

Meelopende bril. Of ook wel losse bril of volg bril genoemd, wordt bevestigd aan de wagen ter ondersteuning van lange delen, voorzien van 2 toetsen en een opening waar het snijgereedschap langs kan bewegen.

Order nr.	713440210	713440230	713440360
Voor type	TU1503V	TU2004V	TU2304V
Maximum buisdiameter (a)	mm 45	40	34
Totale hoogte (b)	mm 155	195	220
Centerhoogte (c)	mm 76	100	107
Prijs	€ 21,90	34,90	49,90

Order nr.	713441310	713441410
Voor type	TU2506	TU2807
Maximum buisdiameter (a)	mm 34	56
Totale hoogte (b)	mm 220	250
Centerhoogte (c)	mm 107	130
Prijs	€ 64,90	79,00

METALWORKS



Precisie meedraaiend kopieercenterpunt 60° (met verlengde punt). Om eenvoudiger bij moeilijker te hanteren werkstukken te komen. Werkplaatskwaliteit. MK1 gewoon meedraaiend centerpunt verkort TU1503V.

Order nr.	Aansluiting MK	Prijs €
713440700 M	1 (korte schacht) D140	50,50
790007216 M	2	30,90
790004697 M	3	39,00
790004698 M	4	41,90
790007214 M	5	92,50

OPTIMUM



Center (meedraaiend) Rohm

Order nr.	713441003 M	713441503 M	713444003 M
Aansluiting	MK 2	3	4
Prijs	€ 103,00	111,00	139,00

OPTIMUM



Set met 1 meedraaiend centerpunt met 7 verwisselbare punten. Lichaam van gehard en geslepen gereedschapsstaal. Precisie-naaldrollagers garanderen een hoge nauwkeurigheid. Verpakt in een kunststof koffer.

Order nr.	713440732 M	713440733 M	713440734 M
Aansluiting	MK 2	3	4
A	mm 22	23	23
B	mm 36	44	51
C	mm 69	86	108
D	mm 32	41	47
D1	mm 25	30	32
Nauwkeurigheid	mm 0,008	0,008	0,008
Maximum snelheid	tpm 4000	3000	2500
Prijs	€ 169,00	198,00	199,00

METALWORKS



Type	D0	D1	D1	D2	D3	D4
Draaigatmeter	mm 2,00-2,20	2,30-3,00	3,00-4,00	4,00-5,00	6,00-7,00	8,00-10,00
Aansluiting	mm 5,2	7	4,5	7	1,8	1,9
Max. hoogte beitelhouder	mm 12	20	20	32	40	62
Max. draaihoek	mm 15	20	20	15	40	40
Max. draaihoek	mm 30	45	5,7	45	45	120
Totaal max. breedte	mm 48	204	132	220	202	281
Totaal hoogte	mm 37	52	44	74	107	124

40 posities snelwissel beitelhouder.

- Geschikt voor alle gangbare draaibanken
- Herhalingsnauwkeurigheid 0,01 mm
- 40 verschillende hoekinstellingen
- Hoogteafstelling d.m.v. kartelschroef
- Kop en houder met profielgeslepen vertanding
- Voor het spelvrij en nauwkeurig inspannen van de houder

Elke set bestaat uit:

- 1 Snelwissel beitelhouderkop
- 3 Beitelhouders voor vierkante beitels type D
- 1 Beitelhouder voor ronde beitels type B

Opmerking: montage en/of aanpassing van de set is niet inbegrepen in de prijs. Dit zijn universele snelwissel beitelhouders, bij elke montage moet de originele beitelhouder v/d draaibank worden aangepast, zie 719000400. Dit bedrag is enkel geldig voor aankoop bij nieuwe draaibanken van Optimum.

Order nr.	Omschrijving mm	Voor type	Prijs €
719000400 M	Montage en aanpassing SWH	alle types	174,00
790007234 M	Snelwisselhouder SWH0	TU1503V-TU2004V	259,00
790007235 M	Snelwisselhouder SWHA1	TU2506-TU2807	399,00
790007236 M	Snelwisselhouder SWHE5	D320-D330-D360	499,00
790007237 M	Snelwisselhouder SWHB2	D420-D460	599,00
790007238 M	Snelwisselhouder SWHC3	D560	699,00
790011000 M	Snelwisselhouder SWHD1	D660-D800	1.390,00

METALWORKS



Afzonderlijke extra beitelhouders voor vierkante beitels type D om uw set uit te breiden. Indien u meer dan 3 vierkante beitelhouders gebruikt.

Order nr.	Voor type	Voor draaibank	Vierkant beitels mm	Lengte mm	Prijs €
790007253 M	A0/SWHAA	TU1503V TU2404- TU2406- TU2506- TU2807	12	50	57,00
790007240 M	A1/SWH1	D320- D330-D360	20	90	61,90
790007243 M	E5/SWH3	D420-D460	20	100	79,00
790007246 M	B2/SWH5	D560	25	120	85,00
790007247 M	B2/SWH5	D660-D800	32	140	119,00
790007250 M	C3/SWH7	D560	32	150	139,00
790007251 M	C3/SWH7	D560	40	170	180,00
790007322 M	D1/SWH9	D660-D800	40	180	259,00
790007323 M	D1/SWH9	D660-D800	50	180	264,00
790007324 M	D1/SWH9	D660-D800	63	180	286,00

METALWORKS



Afzonderlijke extra beitelhouders voor ronde beitels type B om uw set uit te breiden. Op aanvraag zijn ook boorstanghouders en morse konus houders verkrijgbaar.

Order nr.	Voor type	Voor draaibank	Ronde beitels mm	Lengte mm	Prijs €
790007254 M	A0/SWHAA	TU1503V TU2404- TU2406- TU2506- TU2807	12	50	57,00
790007241 M	A1/SWH1	D320- D330-D360	20	90	68,00
790007244 M	E5/SWH3	D420-D460	30	100	90,00
790007248 M	B2/SWH5	D560	32	130	100,00
790007252 M	C3/SWH7	D660-D800	40	160	169,00
790007325 M	D1/SWH9	D660-D800	50	180	286,00
790007326 M	D1/SWH9	D660-D800	63	180	297,00

METALWORKS



Afzonderlijke extra beitelhouders type S voor opname van boorstangen. In combinatie met morse conus bussen kunnen zo morse conus boren worden opgenomen in de snelwissel beitelhouder.

Order nr.	Voor type	Voor draaibank	Boor- stang mm	Lengte mm	Prijs €
790007255 M	A0/SWHAA	TU1503V TU2404- TU2406- TU2506- TU2807	15	50	74,00
790007256 M	A1/SWH1	D210-D250- D240-D280	30	80	96,00
790007257 M	A1/SWH1	D320- D330-D360	20	90	96,00
790007258 M	E5/SWH3	D320- D330-D360	30	100	113,00
790007259 M	E5/SWH3	D420-D460	40	100	116,00
790007260 M	B2/SWH5	D560	40	120	141,00
790007261 M	C3/SWH7	D560	40	150	231,00
790007262 M	C3/SWH7	D660-D800	50	150	239,00
790007327 M	D1/SWH9	D660-D800	63	180	260,00

METALWORKS



Afzonderlijke extra bussen type L voor opname van morse conus boren. In combinatie met boorstanghouder type S kunnen zo morse conus boren worden opgenomen in de snelwissel beitelhouder.

Order nr.	Voor type	Voor draaibank	Boor- stang mm	Lengte mm	Morse konus MK	Prijs €
790007263 M	A1/SWH1	TU2404- TU2406- TU2506- TU2807	30	80	1	22,50
790007264 M	A1/SWH1	TU2404- TU2406- TU2506- TU2807	30	90	2	23,00
790007265 M	E5/SWH3	D320- D330-D360	30	100	2	23,00
790007266 M	E5/SWH3	D320- D330-D360	40	114	3	25,00
790007267 M	B2/SWH5	D420-D460	40	120	2	25,00
790007268 M	B2/SWH5	D420-D460	40	120	3	25,00
790007269 M	B2/SWH5	D420-D460	40	140	4	29,00
790007270 M	C3/SWH7	D560	40	140	3	29,00
790007271 M	C3/SWH7	D560	40	150	4	32,00
790007272 M	C3/SWH7	D560	50	150	4	33,90
790007328 M	D1/SWH9	D660-D800	50	150	3	49,00
790007330 M	D1/SWH9	D660-D800	63	185	5	63,00
790007329 M	D1/SWH9	D660-D800	50	150	5	52,00

HOE EEN GESCHIKTE KLAUWPLAAT KIEZEN VOOR UW DRAAIBANK?



Eerst en vooral dient u te weten wat de spilconus van uw draaibank is, vooreleer u een keuze kunt maken uit een drieklaw of een vierklaw.

Wij hebben in ons gamma 2 types:

1. Klauwplaten DIN6350 kunnen enkel worden gemonteerd in combinatie met een flens. Dus zonder geschikte flens kan u deze klauwplaten niet monteren op uw draaibank.

De klauwplaten DIN6350 zelf zijn eenvoudig te kiezen, de flenzen daarentegen vereisen enige kennis . We hebben getracht dit zo eenvoudig mogelijk op te lossen door onze modellen van draaibanken naast de specifieke flenzen te plaatsen.

2. Onze klauwplaten DIN55029 of het welgekende Camlock systeem hebben een rechtstreekse koppeling, klauwplaat en flens zijn één geheel. Dit heeft als voordeel dat u veel dichter bij de kop van uw draaibank werkt en dus veel stabielere kunt werken en bovendien geen extra flens dient aan te schaffen.

Drieklaw of vierklaw?

Een drieklaw wordt gebruikt om ronde of driehoekige materialen op te spannen. Onze drieklawen zijn manueel en zelfcenterend, de werking van de klauwen wordt geactiveerd door gebruik te maken van de meegeleverde T sleutel in één van de toegangsgaten te plaatsen op de buitendiameter van de klauwplaat.

Wanneer de T-sleutel in wijzerzin wordt gedraaid, wordt een spiraal en rondsel in werking gebracht, die op hun beurt de klauwen gelijktijdig met precies dezelfde beweging naar het center verplaatsen. Als de T-sleutel in tegen wijzerzin wordt gedraaid dan verplaatsen de klauwen zich naar de buitenzijde van de klauwplaat. Onze drieklawen worden voorzien van een stel inwendige en uitwendige klauwen.

Het grootste voordeel van een vierklaw is dat er ook vierkante materialen kunnen worden opgespannen. Onze vierklawen zijn ofwel zelfcenterend zoals de werking van onze drieklaw ofwel onafhankelijk verstelbaar, iedere klaw kan afzonderlijk versteld worden, de klauwen worden niet gelijktijdig geactiveerd. Dus als u afwijkende vormen of excentrisch wenst te draaien, is de onafhankelijke vierklaw de ideale oplossing.

OPTI

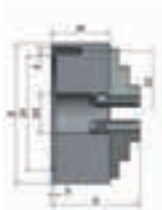

Zelfcentrerende klauwplaat met 3 klauwen DIN6350 voor flensopname.

- Standaard kwaliteit
- Gietijzeren uitvoering
- Met cilindrische opname volgens DIN6350
- Rondloopnauwkeurigheid beter dan 0.05 mm
- Opspanflens is vereist voor deze klauwplaten
- Montage op draaibank niet inbegrepen
- Inclusief set boor- en draaibekken
- Inclusief klauwplaat sleutel

Order nr.	Diameter mm	D	D1	D2	D3	d	H	H1	h	Snelheid tpm	Aan-sluiting Camlock	Prijs €
713440287	80	80	55	66	16	6	66	50	66	4.000,00		89,00
713442710	100	100	72	84	22	8	74,5	55	74,5	3.500,00		99,00
713442712	125	125	95	108	30	8	84	58	84	3.000,00		109,00
713442716	160	160	130	142	40	8	95	65	95	2.150,00		159,00
713442720	200	200			50		128	86	128	2.000,00	6	209,00
713442725	250	250			70		140	98	140	1.600,00	6	269,00
713442731	315	315			105		180	98	180	1.200,00	8	525,00

OPTI

PREMIUM DIN 6386



Zelfcentrerende klauwplaat met 3 klauwen DIN6350 voor flensopname.

- Premium kwaliteit
- Gietijzeren uitvoering CI3P
- Stalen uitvoering CS3C (713442520)
- Met cilindrische opname volgens DIN6350
- Hoogste rondloopnauwkeurigheid gelijk of beter dan DIN6386
- Opspanflens is vereist voor deze klauwplaten
- Montage op draaibank niet inbegrepen
- Inclusief set boor- en draaibekken
- Inclusief klauwplaat sleutel

Order nr.	713442020	713442025	713442520
Diameter	mm 125	160	125
D	mm 125	160	125
D1	mm 95	125	95
D2	mm 108	140	108
D3	mm 32	42	32
d	M 3 x M8	6 x M10	3 x M8
H	mm 76	96,5	76
H1	mm 56	64,5	56
h	mm 76	96,5	76
Snelheid	tpm 3200	3000	4800
Kwaliteit	CI3P	CI3P	CS3C
Omschrijving	gietijzer	gietijzer	staal
Prijs	€ 239,00	295,00	419,00

OPTI



Ongedeelde zachte monoblok klauwen voor de standaard Optimum klauwplaat 3 klauwen met flens en Camlock aansluiting. Zachte klauwen kunnen in om het even welke vorm worden uitgedraaid, zodat een werkstuk eenvoudig kan worden opgespannen (alleen in gespannen toestand). Een set bestaat uit 3 klauwen. Deze klauwen zijn heel specifiek en zijn enkel en alleen bedoeld voor de hierbij opgegeven klauwplaten van Optimum. Deze klauwen gebruiken voor andere Optimum klauwplaten en andere merken werkt niet.

Order nr.	Diameter mm	Voor klauwplaat	Prijs €
713442902	80	713440287	49,00
713442904	100	713442710	59,00
713442906	125	713442712	69,00
713442908	160	713442716 - 713442760	79,00
713442910	200	713442762 - 713442763	99,00
713442912	250	713442765	119,00
713442916	315	713442768	229,00

OPTI



713440312

713440511



713441313

Opnameflens voor het monteren van een klauwplaat 3kl of 4kl DIN6350 zonder rechtstreekse koppeling. Niet voorgedraaid.

Order nr.	Diameter mm	Aansluiting Camlock	Draaibank Camlock	Prijs €
713440312	100	cilindrisch	D180/D280	101,00
713441312	125	Kortegel	D240Vario/ D280Vario	88,50
713441313	125	Kortegel	D240Vario/ D280Vario	88,50
713440511	125	cilindrisch	D250	102,00
713441413	160	kortegel	D280	114,00
713441512	160	D1-4"	D320/D330/ D360	122,00
713441513	200	D1-4"	D320/D330/ D360	141,00
713444012	200	D1-6"	D420/460	141,00
713444013	250	D1-6"	D420/460	180,00
713444041	315	D1-8"	D356/D660/ D800	204,00

Klem -& opspangereedschap

OPTI Line



Zelfcenterende klauwplaat met 3 klauwen DIN55029 Camlock opname.

- Standaard kwaliteit
- Gietijzeren uitvoering
- Directe montage door geïntegreerde flens
- Rondloopnauwkeurigheid beter dan 0.05 mm
- Montage op draaibank niet inbegrepen
- Inclusief set boor- en draaibekken
- Inclusief klauwplaat sleutel

Order nr.	Diameter mm	Aansluiting Camlock	D	D3	H	H1	G	Snelheid tpm	Prijs €
713442760 <small>M</small>	160	D1-4"	160	40	100	70	3	2150	189,00
713442762 <small>M</small>	200	D1-4"	200	50	120	86	3	2000	249,00
713442763 <small>M</small>	200	D1-6"	250	70	140	98	6	1600	259,00
713442765 <small>M</small>	250	D1-6"	200	50	128	86	6	2000	339,00
713442768 <small>M</small>	315	D1-8"	315	105	180	103,5	6	1200	719,00

OPTI Line

PREMIUM DIN 6386



Zelfcenterende klauwplaat met 3 klauwen DIN55029 Camlock opname.

- Premium kwaliteit
- Gietijzeren uitvoering CI3P
- Stalen uitvoering CS3C
- Directe montage door geïntegreerde flens
- Rondloopnauwkeurigheid beter dan 0.05 mm
- Montage op draaibank niet inbegrepen
- Inclusief set boor- en draaibekken
- Inclusief klauwplaat sleutel

Order nr.	Diameter mm	Aansluiting Camlock	D	D3	H	H1	G	Snel-Kwa- heid liteit tpm	Prijs €
713442040 <small>M</small>	160	D1-4"	160	42	125	81,5	3	3000 CI3P	339,00
713442045 <small>M</small>	200	D1-4"	200	55	138	91	3	2500 CI3P	459,00
713442050 <small>M</small>	200	D1-6"	200	55	138	91	6	2500 CI3P	459,00
713442055 <small>M</small>	250	D1-6"	250	76	157,5	103,5	6	2000 CI3P	589,00
713442065 <small>M</small>	315	D1-8"	315	105	181	117,7	6	1500 CI3P	849,00
713442540 <small>M</small>	160	D1-4"	160	42	111,5	68	3	4500 CS3C	559,00
713442545 <small>M</small>	200	D1-4"	200	55	125	78	3	4000 CS3C	739,00
713442550 <small>M</small>	200	D1-6"	200	55	125	78	6	4000 CS3C	739,00
713442555 <small>M</small>	250	D1-6"	250	76	143	89	6	3500 CS3C	980,00
713442560 <small>M</small>	250	D1-8"	250	76	143	89	6	3500 CS3C	980,00
713442565 <small>M</small>	315	D1-8"	315	103	159,5	96,2	6	2800 CS3C	1.520,00
713442575 <small>M</small>	400	D1-8"	400	136	181	102	6	2000 CS3C	2.170,00

OPTI Line



Gedeelde zachte opzetklauwen voor de Premium Optimum klauwplaat 3 klauwen met flens en Camlock aansluiting. Deze opzetklauwen worden bevestigd op de grondbekken van de klauwplaat. Zachte klauwen kunnen in om het even welke vorm worden uitgedraaid, zodat een werkstuk eenvoudig kan worden opgespannen (alleen in gespannen toestand). Een set bestaat uit 3 klauwen. Deze klauwen zijn heel specifiek en zijn enkel en alleen bedoeld voor de hierbij opgegeven klauwplaten van Optimum. Deze klauwen gebruiken voor andere Optimum klauwplaten en andere merken werkt niet.

Order nr.	Diameter mm	Voor klauwplaat	Prijs €
713442522 <small>M</small>	125	713442520 - 713442020	49,00
713442542 <small>M</small>	160	713442540 - 713442025 - 713442040	209,00
713442552 <small>M</small>	200	713442545 - 713442550 - 713442045 - 713442050	79,00
713442562 <small>M</small>	250	713442555 - 713442560 - 713442055	99,00
713442567 <small>M</small>	315	713442565 - 713442065	149,00
713442577 <small>M</small>	400	713442575	209,00

OPTI Line

PREMIUM DIN 6386



Zelfcenterende klauwplaat met 4 klauwen DIN6350 voor flensopname.

- Premium kwaliteit
- Gietijzeren uitvoering CI4P
- Stalen uitvoering CS4C (713442620)
- Met cilindrische opname volgens DIN6350
- Hoogste rondloopnauwkeurigheid gelijk of beter dan DIN6386
- Opspanflens is vereist voor deze klauwplaten
- Montage op draaibank niet inbegrepen
- Inclusief set boor- en draaibekken
- Inclusief klauwplaat sleutel

Order nr.	713442120 <small>M</small>	713442125 <small>M</small>	713442620 <small>M</small>
D	mm 125	160	125
D1	mm 95	125	95
D2	mm 108	140	108
D3	mm 32	42	32
d	M 3 x M8	6 x M10	3 x 8M
H	mm 76	64,5	56
H1	mm 56	64,5	56
h	mm 76	64,5	56
Snelheid	tpm 3200	3000	4800
Prijs	€ 289,00	349,00	499,00

OPTIMUM



Zelfcenterende klauwplaat met 4 klauwen DIN55029 Camlock opname.

- Standaard kwaliteit
- Gietijzeren uitvoering
- Directe montage door geïntegreerde flens
- Rondloopnauwkeurigheid beter dan 0,05 mm
- Montage op draaibank niet inbegrepen
- Inclusief set boor- en draaibekken
- Inclusief klauwplaat sleutel

Order nr.	Diameter mm	Aansluiting Camlock	D	D3	H	H1	G	Snelheid tpm	Prijs €
713442840	160	D1-4"	160	40	95	70	3	2150	229,00
713442844	200	D1-4"	200	50	109	86	3	1700	309,00
713442846	200	D1-6"	200	50	109	86	6	1700	319,00
713442850	250	D1-6"	250	70	120	95	6	1375	399,00
713442854	315	D1-8"	315	105	142,5	106	6	1200	719,00

OPTIMUM

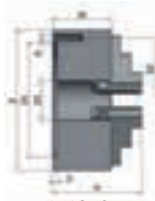

Zelfcenterende klauwplaat met 4 klauwen DIN6350 volgens opname.

- Standaard kwaliteit
- Gietijzeren uitvoering
- Met cilindrische opname volgens DIN6350
- Rondloopnauwkeurigheid beter dan 0,05 mm
- Opspanflens is vereist voor deze klauwplaten
- Montage op draaibank niet inbegrepen
- Inclusief set boor- en draaibekken
- Inclusief klauwplaat sleutel

Order nr.	Diameter mm	D	D1	D2	D3	d	H	H1	h	Snelheid tpm	Prijs €
713442808	80	80	55	66	16	6	66	50	66	4.300	99,00
713442810	100	100	72	84	22	8	74,5	55	74,5	3.400	119,00
713442812	125	125	95	108	30	8	84	58	84	2.750	129,00
713442816	160	160	130	142	40	8	95	65	95	2.150	179,00
713442820	200	200		55	125	78	125	400		3.000	239,00
713442825	250	250		76	143	89	143	3.000		3.290	329,00
713442831	315	315		103	159,5	96,2	159,5	2.800		599,00	599,00

OPTIMUM



Ongedeelde zachte monoblok klauwen voor de standaard Optimum klauwplaat 4 klauwen met flens- en Camlock aansluiting. Zachte klauwen kunnen in om het even welke vorm worden uitgedraaid, zodat een werkstuk eenvoudig kan worden opgespannen (alleen in gespannen toestand). Een set bestaat uit 4 klauwen. Deze klauwen zijn heel specifiek en zijn enkel en alleen bedoeld voor de hierbij opgegeven klauwplaten van Optimum. Deze klauwen gebruiken voor andere Optimum klauwplaten en andere merken werkt niet.

Order nr.	Diameter mm	Voor klauwplaat	Prijs €
713442920	80	713442920	69,00
713442922	100	713442810	79,00
713442924	125	713442924	89,00
713442926	160	713442816 - 713442840	99,00
713442928	200	713442844 - 713442846	139,00
713442930	250	713442850	169,00
713442932	315	713442854	329,00

OPTIMUM

PREMIUM DIN 6386



Zelfcenterende klauwplaat met 4 klauwen DIN55029 Camlock opname.

- **Premium kwaliteit**
- Gietijzeren uitvoering CI4P
- Stalen uitvoering CS4C
- Directe montage door geïntegreerde flens
- Rondloopnauwkeurigheid gelijk of beter dan DIN6386
- Montage op draaibank niet inbegrepen
- Inclusief set boor- en draaibekken
- Inclusief klauwplaat sleutel

Order nr.	Aansluiting Camlock	D	D3	H	H1	Snelheid tpm	Prijs €
713442140	D1-4"	160	42	125	81,5	3000	459,00
713442145	D1-4"	200	55	138	91	2500	559,00
713442150	D1-6"	200	55	138	91	2500	559,00
713442155	D1-6"	250	76	157,5	103,5	2000	780,00
713442165	D1-8"	315	105	181	117,7	1500	1.060,00
713442640	D1-4"	160	42	111,5	68	4500	769,00
713442645	D1-4"	200	55	125	78	4000	1.020,00
713442650	D1-6"	200	55	125	78	4000	1.020,00
713442655	D1-4"	250	76	143	89	3500	1.329,00
713442660	D1-6"	250	76	143	89	3500	1.329,00
713442665	D1-8"	315	103	159,5	96,2	2800	2.070,00
713442675	D1-8"	400	136	181	108	2000	3.050,00

OPTIMUM



Ongedeelde zachte monoblok klauwen voor de Premium Optimum klauwplaat 4 klauwen met flens en Camlock aansluiting. Zachte klauwen kunnen in om het even welke vorm worden uitgedraaid, zodat een werkstuk eenvoudig kan worden opgespannen (alleen in gespannen toestand). Een set bestaat uit 4 klauwen. Deze klauwen zijn heel specifiek en zijn enkel en alleen bedoeld voor de hierbij opgegeven klauwplaten van Optimum. Deze klauwen gebruiken voor andere Optimum klauwplaten en andere merken werkt niet.

Order nr.	Diameter mm	Voor klauwplaat	Prijs €
713442621 M	125	713442120, 713442620	99,00
713442641 M	160	713442125, 713442140	119,00
713442651 M	200	713442145, 713442150	155,00
713442661 M	250	713442155	219,00
713442666 M	315	713442165	309,00

OPTIMUM



Gedeelde zachte opzetklauwen voor de Premium Optimum klauwplaat 4 klauwen met flens en Camlock aansluiting. Deze opzetklauwen worden bevestigd op de grondbekken van de klauwplaat. Zachte klauwen kunnen in om het even welke vorm worden uitgedraaid, zodat een werkstuk eenvoudig kan worden opgespannen (alleen in gespannen toestand). Een set bestaat uit 4 klauwen. Deze klauwen zijn heel specifiek en zijn enkel en alleen bedoeld voor de hierbij opgegeven klauwplaten van Optimum. Deze klauwen gebruiken voor andere Optimum klauwplaten en andere merken werkt niet.

Order nr.	Diameter mm	Voor klauwplaat	Prijs €
713442642 M	160	713442640	89,00
713442652 M	200	713442645, 713442650	99,00
713442662 M	250	713442655, 713442660	139,00
713442622 M	125		69,00

OPTIMUM



Onafhankelijk verstelbare vier klauwen plaat DIN6350 voor flensopname.

- Standaard kwaliteit
- Gietijzeren uitvoering
- Met cilindrische opname volgens DIN6350
- Rondloopnauwkeurigheid beter dan 0.05 mm
- Opspanflens is vereist voor deze platen
- Montage op draaibank niet inbegrepen
- Inclusief set bekken
- Inclusief klauwplaat sleutel

Order nr.	Diameter mm	D	D1	D2	D3	d	H	H1	h	Prijs €
713442872 M	100	72	72	84	25	8	73	54	73	89,00
713442874 M	125	95	95	108	30	8	78	58	78	99,00

OPTIMUM



Onafhankelijk verstelbare vier klauwen plaat DIN55029 Camlock opname.

- Standaard kwaliteit
- Gietijzeren uitvoering
- Directe montage door geïntegreerde flens
- Rondloopnauwkeurigheid beter dan 0.05 mm
- Montage op draaibank niet inbegrepen
- Inclusief set bekken
- Inclusief klauwplaat sleutel

Order nr.	Diameter mm	Aansluiting Camlock	D	D3	H	H1	G	Prijs €
713442876 M	160	D1-4"	160	45	93	65	3	199,00
713442878 M	200	D1-4"	200	50	110	75	3	229,00
713442880 M	200	D1-6"	200	56	107	75	6	229,00
713442884 M	250	D1-6"	250	66	117,5	82	6	239,00
713442888 M	315	D1-8"	315	95	134	90	6	359,00
713442890 M	400	D1-8"	400	125	143	95	6	499,00

Taphouders

OPTIMUM



Tapapparaat. Geschikt voor zowel boor- als freesmachines. Een dubbel veermechanisme voor de automatische voeding en slipkoppeling, ter preventie van het breken van tappen. Werkt met standaard machinetappen. Geleverd met 2 rubberen flexibele spantangen, maar zonder kegeldoorn. Voor de gewenste kegeldoorn voor uw machine met B16 zie index.

Flex spantangen. Rubberen flexibele spantangen voor tapapparaat zijn afzonderlijk verkrijgbaar.

Order nr.	713352042 M		
Orig. nr.	TALR512B16		
Capaciteit	M	M5-M12	
Aansluiting	B16		
Prijs	€	399,00	

METALWORKS



Tappen met uw boormachine? Dan kan!

Tapapparaat met morse konus opname, werkt met tappotten. Tappotten niet inbegrepen. Voor boormachines uitgerust met een tafunctie en boormachines met links-rechts draaiend.

* Met de adaptor 790004476 kunt u het tapapparaat 790024020 van M3 tot M24 tappotten gebruiken.

* Met de adaptor 790004477, kunt u het tapapparaat 790024022 van M6 tot M40 tappotten gebruiken.

Order nr.	790024018 M	790024020 M	790024022 M
Orig. nr.	TA1MK2	TA2MK3	TA3MK4
Capaciteit	M	M3-M12	M6-M24
Opname	19	31	48
Prijs	€	61,00	143,00
			287,00

Werkstukklemming tafel

METALWORKS



Professionele stalen bankschroef. Onbreekbaar. Industriële kwaliteit. Gietstalen constructie. Met 360° draaibare basis, gehard aambeeld en pijpbecken. Met schroeven om de geleiding aan te passen.

Order nr.	Orig. nr.	Spanwijdte mm	Bekhoogte mm	Gewicht kg	Prijs €
909061000 T	BAP100	100	130	7,50	69,00
909061250 T	BAP125	125	155	11,00	99,00
909061500 T	BAP150	150	180	14,50	129,00
909061750 T	BAP175	175	210	14,50	179,00

METALWORKS



Stalen bankschroef. Onbreekbaar. Industriële kwaliteit. Gietstalen constructie in staal SC37. Met 360° draaibare basis, gehard aambeeld en pijpbecken. Zwarte warmverlakte afwerking.

Order nr.	Orig. nr.	Spanwijdte mm	Bekhoogte mm	Gewicht kg	Prijs €
909070750 T	BAGSY3	75	50	6,00	57,00
909071000 T	BAGSY4	100	60	7,50	59,00
909071250 T	BAGSY5	125	70	11,00	79,00
909071500 T	BAGSY6	150	75	14,50	99,00
909072000 T	BAGSY8	200	90	20,50	139,00
909072500 T	BAGSY10	250	100	25,60	224,00

METALWORKS



Vervangbek voor BAGSY.

Order nr.	Orig. nr.	Voor type	Gewicht kg	Prijs €
909075143 T	BAGSY4J	BAGSY4	0,30	7,10
909075144 T	BAGSY5J	BAGSY5	0,35	17,50
909075145 T	BAGSY6J	BAGSY6	0,39	16,50
909075146 T	BAGSY8J	BAGSY8	0,39	18,90
909075147 T	BAGSY10J	BAGSY10	0,50	23,90

METALWORKS



Set zachte aluminium klauwen. Met magnetische strip voor het vasthechten op becken. Geschikt voor elke klassieke bankschroef.

Order nr.	909079150 E	909079100 T	909079125 T
Orig. nr.	MGNALU150	MGNALU100	MGNALU125
Lengte	150mm	100mm	125mm
Gewicht	kg	0,21	0,21
Prijs	€	8,60	6,90
			7,60

HOE EEN GESCHIKTE BOORKLEM KIEZEN VOOR UW BOORMACHINE?

U meet de tafelfmeting van uw boormachine in breedte en diepte op in mm, vervolgens kiest u een boorklem die het beste bij u past en vergelijkt u de breedte en diepte van de boorklem. Komt de boorklem te ver uit uw boortafel dan is deze te groot en niet geschikt voor uw boormachine. Hou ook rekening met de T-gleuven in de tafel en de gleuven in de boorklem. Vergeet bij het bestellen van uw boorklem uw T-toeren niet bij te bestellen.

OPTIMUM



Profi-bankschroef met pedaalsysteem om een veilig en snel opspannen van het werkstuk. Naregelbare zwaluwstaartuitvoering. Ingebouwde schaal. Sferisch gietijzer 500 Nm/mm² kwaliteit. Standaard met 4 types klauwen. (Effen - Geribde - Prismabekken en zachte alu bekken).

Order nr.	713000513
Orig. nr.	WBS135
Bekbreedte	mm 135
Spanwijdte	mm 110
Bekdiepte tot onderste deel	mm 72
Bekdiepte tot spindelhuiskop	mm 195
Maximum gereedschapsgewicht	kg 50
Werkbladddikte	mm 45
Gewicht	kg 26,00
Prijs	€ 375,00

OPTIMUM



Set snijbekken voor WBS 135.

Order nr.	713000518
Orig. nr.	3000518
Gewicht	kg 7,45
Prijs	€ 154,00

METALWORKS



Kruistafel voor kolomboormachines. Semi-professioneel gebruik. Gietijzeren constructie.

Order nr.	101075145	151575145
Bekbreedte	mm 100	150
Spanwijdte	mm 95	150
Dwarskoers	mm 100/150	150/200
Centerafstand bevestigingsgaten	mm 125	160
Prijs	€ 49,00	69,00

OPTIMUM



Professionele kruistafel voor individuele montage op bestaande machines. Met een opvangruimte voor de koelmelk. Reduceerbare speling dankzij de zwaluwstaartconstructie. Verplaatsing van de tafel dmv een handwiel met schaalverdeling 0,05mm. Opmerking : Dit is een universele kruistafel. Dit betekent dat in sommige gevallen een aanpassing en/of tussenstuk zal nodig zijn om de kruistafel met de montagetafel te verbinden. Deze aanpassing is leverbaar tegen meerprijs. Hiervoor onze technische dienst raadplegen.

Order nr.	Afmetingen tafel (b x d) mm	Afmetingen T-gleuf mm	Koers X/Y mm	Afmetingen voet (b x d) mm	Prijs €
713356595	400x120	10	220x165	280x220	399,00
713356596	500x180	12	280x175	340x274	549,00
713356591	700x180	12	480x175	340x274	669,00
713356600	730x210	14	480x210	362x280	795,00

OPTIMUM

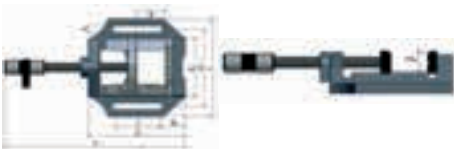

	MSO 75	MSO 100	MSO 125	MSO 150
A	12,5	12,5	12,5	14,5
B	55	90	110	130
C	55	74	80	100
D	30	46	46	56
E	126	165	186	222
F	270	350	400	455
G	75	100	125	150
H	100	130	150	170
I	130	165	182	208
J	28	28	30	35

Universele boorklem met prismabekken. Werkplaatskwaliteit.

Order nr.	Orig. nr.	Bek- breedte mm	Bek- hoogte mm	Span- wijdte mm	Breedte I mm	Diepte E mm	Prijs €
713000075	MSO75	75	28	55	130	126	22,50
713000100	MSO100	100	28	90	165	165	26,00
713000125	MSO125	125	30	110	182	186	31,50
713000150	MSO150	150	35	130	208	222	35,00

OPTIMUM



	BMS 85	BMS 100	BMS 120	BMS 150	BMS 200
A	11	12,5	12,5	12,5	12,5
B	70	90	110	120	160
C	100	120	140	170	210
D	27	30	40	40	50
E	110	115	115	115	115
F	100	120	140	160	210
G	150	170	180	220	260
H	200	200	200	270	440
I	80	100	120	150	200
J	100	120	140	170	210
K	120	150	170	200	250
L	27	30	35	40	40

Universele boorklem met prismabekken. Professionele kwaliteit.

Order nr.	Orig. nr.	Bek- breedte mm	Bek- hoogte mm	Span- wijdte mm	Breedte K mm	Diepte G mm	Prijs €
713000008	BMS85	85	27	70	130	152	40,50
713000010	BMS100	100	30	90	150	170	56,00
713000012	BMS120	120	35	110	170	193	69,90
713000015	BMS150	150	45	130	200	228	84,50
713000020	BMS200	200	60	160	252	262	107,00

OPTIMUM

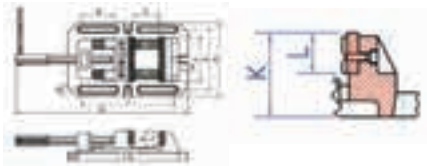

	BSI 100	BSI 140	BSI 200
A	350-460	455-610	578-788
B	88	105	163
C	110	150	200
D	12	14	16
E	19	23	28
F	100	140	200
G	136	189	250
H	170	230	290
I	12	14	14
J	216	290	406
K	72	90	114
L	40	50	64

Machineklem van industriekwaliteit. Met verwisselbare prismabekken. Veel montage mogelijkheden op de boortafel door langwerpige sleufgaten. Prismabekken precisiegeslepen. Hoogwaardig gietijzer. Geschaafde geleidingsvlakken.

Zie detailfoto. Hoe steviger en langer de geleiding van de beweegbare bek wordt geleid, hoe minder kans dat uw werkstuk wordt gelift.

Order nr.	713000210	713000214	713000220
Orig. nr.	BSI100	BSI140	BSI200
Bekbreedte	mm 100	140	200
Bekhoogte	mm 40	50	64
Spanwijdte	mm 110	150	210
Breedte H	mm 170	230	290
Diepte J	mm 216	290	406
Totale hoogte	mm 72	90	114
Prijs	€ 129,00	215,00	267,00

OPTIMUM



Snelspan machineklem van industriekwaliteit. Exacte bekkengeleiding, ook bij axiale last. Spindel met gerolde trapeziumdraad. Met prismabek op de vaste bek, precisie geslepen. Veel montage mogelijkheden op de boortafel door langwerpige sleufgaten. Hoogwaardig gietijzer. Geschaafde geleidingsvlakken bieden een soepele bediening.

Order nr.	713000230	713000234	713000240
Orig. nr.	BSI-Q100	BSI-Q140	BSI-Q200
Bekbreedte	mm 100	140	200
Spanwijdte	mm 105	155	220
Gewicht	kg 8,00	17,00	38,00
Prijs	€ 149,00	209,00	279,00

METALWORKS



Boorklem met snelspan-sluiting. U trekt met één handbeweging de beweegbare bek langsheen de volledige spanwijdte en u klemt met de andere hendel.

Order nr.	713002100	713002125
Orig. nr.	BSK100	BSK125
Bekbreedte	mm 105	120
Spanwijdte	mm 95	95
Breedte	mm 160	160
Diepte	mm 305	305
Prijs	€ 42,50	53,50

OPTIMUM

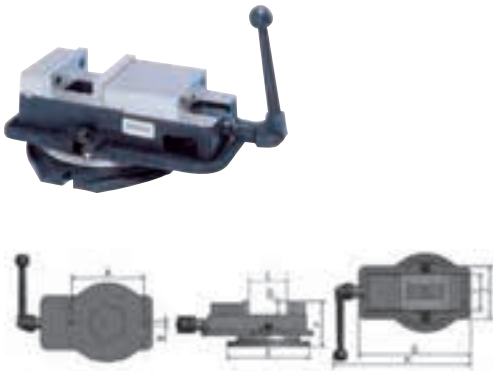

Technische Daten	A	B	C	D	E	F	G	H	I	J	Kg
FMSN 100	mm	100	14,5	101	31	101	110	325	310	300	110
FMSN 125	mm	125	16,5	126	33	126	128	369	310	310	128
FMSN 150	mm	150	18,5	146	33	146	146	425	310	310	150

- Mechanische precisie machineklem.
- Neertrekmechanica voor het zekerder spannen van het werkstuk.
 - Machineklem is uit hoogwaardig gietijzeren vervaardigd.
 - De geleidingsvlakken zijn gehard en geslepen.
 - Uitswisselbare geharde en geslepen bekken.
 - Afgeschermd spindel
 - Door het omwisselen van de bekken ook naar buiten spanvend.
 - Met draivoet, 360° verdraaibaar.

Order nr.	Orig. nr.	Bek-breedte mm	Bek-hoogte mm	Span-widte mm	Totale lengte mm	Prijs €
713354110	FMSN100	100	31	101	325-119	269,00
713354120	FMSN125	135	33	108	369-128	294,00
713354130	FMSN150	150	46	146	425	329,00

OPTIMUM



Prismabek voor precisie machineklemmen type FSMN

Order nr.	Orig. nr.	Prijs €
713354112	PBFN100	55,00
713354122	PBFN125	64,00
713354132	PBFN150	37,00

OPTIMUM

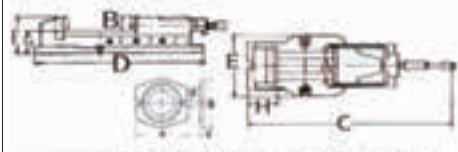

Order nr.	A	B	C	D	E	F	G	H	I	J	Kg
HMS100	mm	100	27	127	36	127	128	369	310	310	128
HMS125	mm	125	27	127	36	127	128	369	310	310	128
HMS150	mm	150	27	127	36	127	128	369	310	310	128
HMS200	mm	200	27	127	36	127	128	369	310	310	128

Hydraulische precisie machineklem voor een trefzeker spannen van het werkstuk. Met geharde en geslepen uitwisselbare bekken. Dank zij het Booster-systeem wordt een hoge klemspanning bereikt met weinig kracht. Op 360° draaibare basis. Beschermd draaispil. Vervaardigd uit hoogwaardig gietstaal.

Order nr.	713355100	713355127	713355150	713355200
Orig. nr.	HMS100	HMS125	HMS150	HMS200
Bekbreedte mm	100	127	150	200
Bekhoogte mm	36	46	51	65
Spanwijdte mm	0-60;57-115;110-170	0-80;78-115;140-208	0-100;98-200;195-300	0-100;98-200;195-300
Totale lengte mm	525	670	800	800
Prijs €	535,00	559,00	569,00	980,00

OPTIMUM



Prismabek voor hydraulische precisie machineklem type HMS.

Order nr.	Orig. nr.	Bekbreedte mm	Prijs €
713355102	PBH100	100	42,00
713355129	PBH125	125	44,00
713355152	PBH150	150	69,00

OPTIMUM



Twee-assige mechanische freesklem. Verticaal als horizontaal kantelbaar tot 90°. 360° draaibaar op draaitafel. Geharde en geslepen bekken. Afleesscalen op beide assen.

Order nr.	713354170	
Orig. nr.	ZAS50	
Bekbreedte	mm	50
Bekhoogte	mm	22
Spanwijdte	mm	46
Totale lengte	mm	205
Totale hoogte	mm	87
Prijs	€	129,00

OPTIMUM

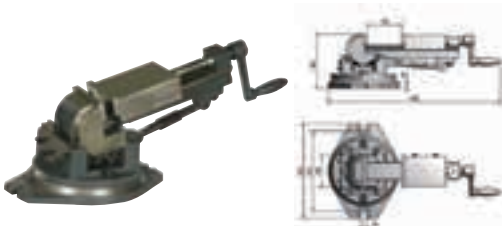

Drie-assige mechanische freesklem. Uit hoogwaardig gietijzer. Verticaal als horizontaal kantelbaar tot 90°. 360° draaibaar op draaitafel en +/-45° verticale zwenkbeweging over de spindel. Geharde en geslepen bekken. Afleesscalen op alle 3 assen. Industrielijke kwaliteit. Prismabekken verkrijgbaar met ordernr. 713355502.

Order nr.	713355500	
Orig. nr.	DAS100	
Bekbreedte	mm	100
Bekhoogte	mm	38
Spanwijdte	mm	105
Totale hoogte	mm	172
Totale lengte	mm	631
Prijs	€	439,00

OPTIMUM



	A	B	C	D	E	F	G	H	I	J	kg
MV3-75	mm	166	195	12	139	82	34	150	195	25,5	11
MV3-125	mm	212	260	12	185	97	45	206	290	125	26

Drie-assige mechanische freesklem. Uit hoogwaardig gietijzer. Verticaal als horizontaal kantelbaar tot 90°. 360° draaibaar op draaitafel en +/-45° verticale zwenkbeweging over de spindel. Geharde en geslepen bekken. Afleesscalen op alle 3 assen. Semi-professionele kwaliteit.

Order nr.	713354175	713354178	
Orig. nr.	MV3-75	MV3-125	
Bekbreedte	mm	75	125
Bekhoogte	mm	33	45
Spanwijdte	mm	82	97
Totale hoogte	mm	150	206
Prijs	€	239,00	299,00

METALWORKS



A	B	C	D	E	F	G	H	J	K	L	Max. Clamping Force (kg)	
110	38	170	80	15	15	28	240	270	300	400	330	2300
150	54	200	80	20	15	28	300	330	360	415	280	4000

Schuinstelbare hydraulische machineklem. Robuust gebouwd voor het frezen, boren en slijpen. Machineklem is vervaardigd uit hoogwaardig gietijzer. Geleidingvlakken zijn gehard en geslepen. Uitwisselbare geharde en geslepen bekken. Booster systeem: met weinig kracht wordt een hoge spankracht verzekerd. Afgedekte spindel. Een wijder spanbereik door vergrendelingsbouten met verschillende afstandgaten. Schuinstelbaar van 0° tot 50°. Voorzien van een afleesschaal. Met draaivoet, 360° verdraaibaar.

Order nr.	790000070	
Orig. nr.	SHM150	
Bekbreedte	mm	150
Bekhoogte	mm	54
Spanwijdte	mm	0 - 300
Prijs	€	1.259,00

Klem -& opspangereedschap

OPTIMUM



Parallel onderlegplaten set 20dlg.

- Voor het parallel opnemen van werkstukken in machineklemmen, opspanplaten, werktuigmachines, dit om een preciezere bewerking te bekomen.
- Fijn geslepen op 0,01 mm nauwkeurig
- Inhoud 20 dlg:
 - 2 x 13 x 3 x 150 mm
 - 2 x 16 x 3 x 150 mm
 - 2 x 19 x 3 x 150 mm
 - 2 x 22 x 3 x 150 mm
 - 2 x 28 x 3 x 150 mm
 - 2 x 31 x 3 x 150 mm
 - 2 x 35 x 3 x 150 mm
 - 2 x 38 x 3 x 150 mm
 - 2 x 41 x 3 x 150 mm
- In een praktische kunststofkoffer.

Order nr.	713354001
Orig. nr.	POP20
Stuks	20
Kalibers	van 13x3x150 tot 41x3x150
Prijs	€ 130,00

OPTIMUM



- Voor het parallel opnemen van werkstukken in machineklemmen, opspanplaten, werktuigmachines, dit om een preciezere bewerking te bekomen.
- Set bestaande uit 18 blok kalibers. HRC 50-55.
- Speciaal gehard staal.
- Geslepen en handgepolijst per paar op 0.01 mm nauwkeurig.
- In een praktische kunststofkoffer.
- Inhoud 18 dlg
 - 2 x 16 x 5 x 100 mm
 - 2 x 18 x 6 x 100 mm
 - 2 x 24 x 8 x 100 mm
 - 2 x 30 x 10 x 100 mm
 - 2 x 36 x 12 x 150 mm
 - 2 x 48 x 14 x 150 mm
 - 2 x 60 x 18 x 150 mm
 - 2 x 62 x 22 x 150 mm
 - 2 x 31 x 15 x 200 mm

Order nr.	713354000
Orig. nr.	VP-100
Stuks	18
Kalibers	van 5x16x100 tot 22x62x150
Prijs	€ 199,00

METAL WORKS

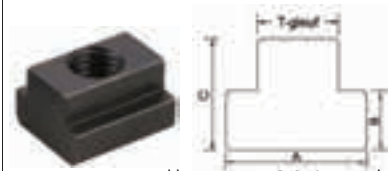

T-moeren voor spanklemmen. HRC 34°. Te gebruiken op boor- en freestafels met T-gleuven. Warmte behandelde en zwart geoxideerde stalen uitvoering. Geleverd per stuk.

Order nr.	Maat	Groote T-gleuf	A	B	C	Prijs
	mm	mm	mm	mm	mm	€
713353020	M8	10	16	6	12	3,40
713353022	M10	12	18	7	14	4,05
713353024	M125	15,7	22	8	16	4,10
713353025	M12	14	25	8	16	4,10
713353026	M14	16	25	8	16	4,10
713353028	M16	18	28	11	20	4,05
790000274	M18	20	32	12	24	4,40

METAL WORKS



Set complete spanbouten. Ideaal om uw machineklem vast te maken aan uw boor-/freestafel, kruistafel. 1 set bestaat uit 4 flensmoeren, 2 draadstiften 75 mm (100 mm voor M16), 2 draadstiften 125 mm (150 mm voor M16) en 4 T-moeren. Om een machineklem degelijk op te spannen hebt u minstens twee complete spanbouten nodig. Prijs per set.

Order nr.		790007315	790007317	790007319
Groote T-gleuf	mm	12	14	18
Maat		M10	M12	M16
Aantal stuks in set		16	16	16
Prijs	€	19,00	21,50	29,50

OPTIMUM



58 delig assortiment opspangereedschap. Met praktische muurhouder. Metrische draad. Zwart geanodiseerde uitvoering. Set bestaande uit : 24 aantrekbouten (75, 125, 150, 175 en 200mm), 6 stuks T-sleufblokken, 6 moeren, 4 verlengingsmoeren, 6 spanstempels en 6 spanblokken.

Order nr.	Voor T-gleuven	Binnendraad	Voor type	Prijs
	mm	M		€
713352015	10	M8	BF16	58,50
713352016	12	M10	BF20-BF20L-BF30-F40E	69,00
713352017	14	M12	UF100	79,00
713352018	16	M14	F30-F45-MF2-MF4	99,00
713352019	18	M16	BF46 Vario	105,00

OPTIMUM



Aandrukkers. Beide uiteinden van de aandrukker zijn voorzien van een messing beschermplaatje. De gesmede klembeugel is verstelbaar in de hoogte. Materiaal S45C. Geleverd per paar.

Order nr.	713352031 M	713352032 M
Voor T-gleuven	16	18
Aantrekdraad	M12	M16
Hoogte mm	0-89	0-101
Prijs €	70,50	83,50

METALWORKS



Permanente magnetische opspanplaat of ook gewoonweg magneet of trekstaal genoemd. Deze magneten hebben een aantrekking op ijzeren voorwerpen. Fijne polariteit, want hoe dichter de polen hoe groter de aantrekkingskracht. Trekkraft van 100 N/cm². Magneet wordt eenvoudig geactiveerd door de bijgeleverde hendel over te draaien. Kan gebruikt worden op slijpmachines, freesmachines en CNC machines, deze laatste afhankelijk van vermogen en degelijke opspanning.

Order nr.	H mm	T mm	Polariteit	Prijs €
790001091 M	48	20	0,5+1	318,00
790001092 M	48	20	0,5+1	369,00
790001093 M	53	20	0,5+1	398,00
790001094 M	53	22	0,5+1	565,00

OPTIMUM



Horizontale en verticale draaitafel gemaakt uit een hoogwaardig Meehanite staal. Zeer nauwkeurige tafel ook onder belasting. Met precisie lagere uitgevoerd. Grote spilboring voor het opspannen van langere werkstukken. Snelindeling voor grotere series. Geharde en geslepen worm. Verhouding 90:1. Schaalverdeling op de werktafel van 360°. 1 handwiel-omwenteling geeft een verplaatsing van 4°. Aparte verdeelplaten, tegenpunten en opnameflensen zijn optioneel leverbaar.

Order nr.	Orig. nr.	Tafel-dia- meter (D)	Bouw- hoog- meter te (H)	Cent- ter- te (H1)	T-gleuf (E)	Belas- ting (hori- zontaal)	Belas- ting (verti- caal)	Center- gat	Prijs €
713356110 M	RT100	110	72	80	11	35	18	MK2	279,00
713356150 M	RT150	150	80	102	11	40	20	MK2	269,00
713356200 M	RT200	200	102	135	14	80	40	MK3	429,00
790000004 M	RT250	250	109	163	14	90	50	MK3	669,00
790000005 M	RT300	300	125	194	16	120	60	MK4	739,00

OPTIMUM

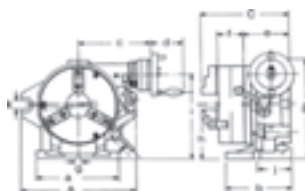

Horizontale en verticale draai- en indexeertafel met voorgemonteerde klauwplaat 3kl, vlakplaat en vergrendelingsplaten

- Kwaliteits draaitafel uit hoogwaardig Meehanite gietijzer
- Precisie conische lagere
- Wormaandrijving mechanisme
- Stabiliteit gegarandeerd ook onder intens gebruik
- Zelfcenterende klauwplaat 3kl
- Grote spilboring voor het spannen van lange werkstukken
- Gradenverdeling over een schaal van 360°
- Directe verdeling over vergrendelingsplaten
- Verdeling mogelijk over 24 posities (per 15°)
- 7 vergrendelingsplaten voor 2 - 3 - 4 - 6 - 8 - 12 en 24 opdelingen.
- Met handwielaandrijving en nonius

Geleverd met **opspanschild** met opspangleuven

Order nr.	713354165 M	790000032 M
Orig. nr.	RTU165	RTU210
Bouwhoogte mm	221	243
Breedte mm	250	310
Lengte mm	235	285
Centerhoogte mm	123	155
Doorlaat mm	44	63
Tafeldiameter mm	165	210
Diameter opspanschild mm	203	254
Prijs €	899,00	1.290,00

OPTIMUM

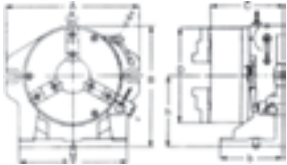

Horizontale en verticale draai- en indexeertafel met voorgemonteerde klauwplaat 3kl en vergrendelingsplaten. Ten opzichte van RTU model **zonder vlakplaat**.

- Kwaliteits draaitafel uit hoogwaardig Meehanite gietijzer
- Precisie conische lagers
- Stabiliteit gegarandeerd ook onder intens gebruik
- Zelfcentrerende klauwplaat 3kl
- Grote spilboring voor het spannen van lange werkstukken
- Gradenverdeling over een schaal van 360°
- Directe verdeling over vergrendelingsplaten
- Verdeling mogelijk over 24 posities (per 15°)
- 7 vergrendelingsplaten voor 2 · 3 · 4 · 6 · 8 · 12 en 24 opdelingen

Order nr.	713356365 ^M	790000034 ^M
Orig. nr.	RTE165	RTE200
Bouwhoogte	mm 218	257
Breedte	mm 260	312
Lengte	mm 220	258
Centerhoogte	mm 123	155
Doorlaat	mm 44	58
Tafeldiameter	mm 165	200
Prijs	€ 699,00	899,00

METALWORKS

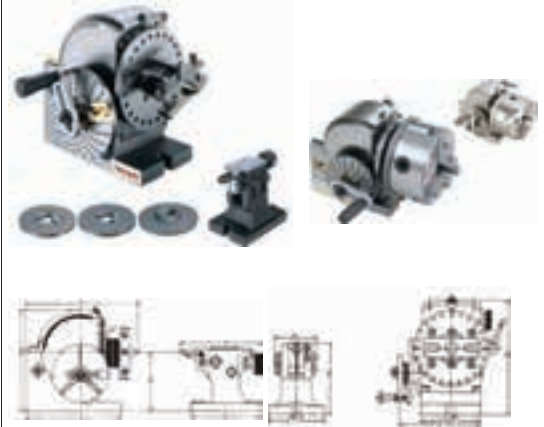

TA. Semi-universele verdeelkoppen.

- Deze halfuniversele verdeelkoppen kunnen iedere hoek verdelen via de directe, indirecte of differentiale methode.
- De verhouding tussen worm en wormwiel bedraagt 40:1
- Worm en wormwiel zijn gehard en geslepen
- De geharde en geslepen spindel wordt stevig vastgehouden in een conische kogellager
- De verdeelkop kan onder hoek vastgezet worden van -10° tot +90°
- Ieder model heeft een draadspil en een verdeelschijf met 24 gaten om eenvoudig en snel direct te kunnen indexeren op de nummers 2, 3, 4, 6, 8, 12 en 24
- Eenvoudige indexering van alle nummers van 2 tot 50 en vele verdelingen van 52 tot 380.
- De TA160 is ook uitgerust met differentiaal indexering voor alle nummers van 2 tot 380 en voor spiraal snijden.
- Nauwkeurig en robuust van vorm

Standaard geleverd met

- 3 verdeelschijven
- verstelbaar tegenpunt
- zonder klauwplaat

790000026 **met klauwplaat ø 125**

790000027 **met klauwplaat ø 160**

Order nr.	Orig. nr.	Bouw- hoogte	Breedte	Lengte	Center- hoogte	Conus	Door- laat	Prijs
		mm	mm	mm	mm		mm	€
713356125 ^M	TA125	173	91	189	100	MK2	18	459,00
790000025 ^M	TA160	220	114	293	128	MK3	20	595,00
790000026 ^M	TA125 M2	173	91	189	100	MK2	18	599,00
790000027 ^M	TA160 M3	220	114	293	128	MK3	20	799,00

OPTIMUM

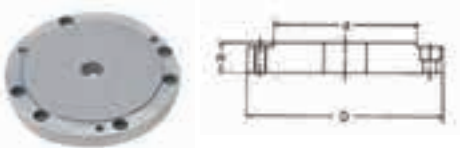

Onze draaitafels kunnen worden voorzien van verschillende optionele artikelen. Zo kan iedere draaitafel worden uitgerust met een bijhorende klauwplaat, hiervoor kiest u eerst de correcte opnameflens en de desbetreffende klauwplaat, vervolgens kan u nog opteren voor de verdeelschijven en een tegenpunt, die in de hoogte verstelbaar zijn.

Order nr.	Omschrijving	D mm	H mm	Prijs €
790007305 M	Opnameflens voor RT100	-	-	73,50
713356154 M	Opnameflens voor RT150	110	20	89,00
713356254 M	Opnameflens voor RT200	138	20	101,00
790000013 M	Opnameflens voor RT250	170	21	112,00
790000014 M	Opnameflens voor RT300	195	24	127,00

OPTIMUM



Klauwplaten 3 klauwen voor draaitafels.

Order nr.	Voor	Dia- me- ter	Buiten- dia- meter	Bin- nendi- meter	D2	D1	D3	L	L1	H	Prijs
		mm	mm	mm	mm	mm	mm	mm	mm	mm	€
790007306 M	RT100	100	2 · 90	30 · 80	72	84	22	74,5	55	3,50	214,00
713356100 M	RT150	130	3 · 130	40 · 120	100	115	33	78	55	3,50	268,00
713356225 M	RT200	160	3 · 60	55 · 145	130	142	40	95	65	5,00	294,00
790007307 M	RT250	190	4 · 190	65 · 190	155	172	55	105	75	5,00	327,00
790007308 M	RT300	200	4 · 200	65 · 200	165	180	70	709	75	5,00	337,00

OPTIMUM



Verdeelschijven.

Order nr.	Omschrijving	Prijs €
713356152 M	Verdeelschijven IT150 voor RT100 RT150. 3 verdeelschijven, sectorarm, hoekklem. - Schijf A gatenverdeling: 15, 16, 17, 18, 19, 20. - Schijf B gatenverdeling: 21, 23, 27, 29, 31, 33. - Schijf C gatenverdeling: 37, 39, 41, 43, 47, 49.	112,00
713356205 M	Verdeelschijven IT200 voor RT200 RTU165. 2 verdeelschijven, sectorarm, hoekklem. - Schijf A gatenverdeling: 28, 30, 34, 38, 41, 44, 47, 51, 57, 28, 32, 37, 39, 43, 45, 49, 53, 59. - Schijf B gatenverdeling: 61, 67, 71, 77, 81, 87, 91, 97, 63, 69, 73, 79, 83, 89, 93, 99.	139,00
790000021 M	Verdeelschijven IT300 voor RT250 RT300 2 verdeelschijven, sectorarm, hoekklem - Schijf A gatenverdeling: 28, 30, 34, 38, 41, 44, 47, 51, 57 28, 32, 37, 39, 43, 45, 49, 53, 59 - Schijf B gatenverdeling: 61, 67, 71, 77, 81, 87, 91, 97 63, 69, 73, 79, 83, 89, 93, 99	175,00

OPTIMUM



Losse kop. In de hoogte verstelbare tegenpunten voor draaitafels en verdeelafels.

Order nr.	713356155 M	713356157 M	790000017 M
Voor type	RT100-RT150	RT200-RTE165-RTU165	RT250 - RT300
Voor center-hoogte	mm	72-108	110-145
Prijs	€	126,00	140,00
			157,00



Machineverlichting

OPTIMUM



Optimum. AL12. LED werklamp AL12.

- Energiebesparend
- LED lamp met lange levensduur
- Verlichtingssterkte 250 – 330 Lux
- Optimale beweeglijkheid van de arm
- Hoge positioneernaauwkeurigheid
- Magneetvoet ø 68 mm en montageplaat 68x68 mm
- Geïntegreerde transformator 6W/230V aansluiting
- Lengte arm 400 mm
- 1.95 W

Order nr.	713351131
Orig. nr.	3351131
Prijs	€ 71,90

OPTIMUM



Optimum. LED machineverlichting.

- Energiebesparend.
- LED lamp met lange levensduur 60.000 werkuren.
- Hoge positioneernaauwkeurigheid.
- Optimale beweeglijkheid van de arm
- 500 mm lange beschermd arm
- kabellengte 1.2 m
- Verlichtingstemperatuur 4000 - 4500 K, natuurlijk helwit
- Beschermklasse IP64
- 24V verlichting
- 3 x 1 Watt / 230V aansluiting

Order nr.	713351010
Orig. nr.	LED 3-500
Prijs	€ 134,00

OPTIMUM



Halogeen werklamp AL35.

- Geconcentreerde halogeenverlichting voorzien van interne stralingsverbredende reflector.
- Montageplaat 68x68 mm
- Alu-geribde stabiele behuizing, beschermt tegen water, olie, stof en stoten.
- Bescherming IP65
- Aangename geringe buitentemperatuur
- Armgewricht bij de kop
- 12V – verlichting
- Geïntegreerde transformator 55W/230V aansluiting

Order nr.	713351152
Orig. nr.	AL35
Prijs	€ 133,00

OPTIMUM



Vervanglamp voor AL35.

Order nr.	710000003
Orig. nr.	64151
Prijs	€ 10,50

OPTIMUM



- Machinelamp kort. Robuuste en lichtsterke machineverlichting:
- Ultramoderne LED technologie
 - Geringe buitentemperatuur, zodat smeer en koelmiddel niet kunnen inbranden
 - Stofdicht en straalwaterbestendig
 - Verdraaibare kop
 - Lichtverdeling: midden breed, asymmetrisch, 25° uitstraalhoek
 - Lampbescherming uit temperatuursongevoelig veiligheidsglas
 - Beschermklasse IP65 (lampenkop)
 - Kleurtemperatuur 4000 - 4500 K
 - Lengte kabel circa 1.2 m
 - Kleur zilver/zwart
 - LED 8 x 1W
 - 230V - 50Hz

Order nr.	713351021
Orig. nr.	LED 8-100
Prijs	€ 145,00

OPTIMUM



Robuuste en lichtsterke machineverlichting:

- Ultramoderne LED technologie
- Geringe buitentemperatuur, zodat smeer en koelmiddel niet kunnen inbranden
- Stofdicht en straalwaterbestendig
- Verdraaibare kop
- Lichtverdeling: midden breed, asymmetrisch, 25° uitstraalhoek
- Lampbescherming uit temperatuursongevoelig veiligheidsglas
- Gelede armlengte 505 mm (LED 8-600) - 720 mm (LED 8-720)
- Beschermklasse IP65 (lampenkop)
- Kleurtemperatuur 4000 - 4500 K
- Lengte kabel circa 1.2 m
- Kleur zilver/zwart
- LED 8 x 1W
- 230V - 50Hz

Order nr.	713351027
Orig. nr.	LED 8-720
Prijs	€ 165,00

OPTIMUM

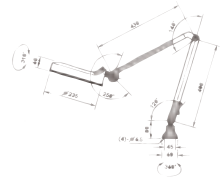

Vergrootglas met geïntegreerde lamp ALM3.

- 1,5 x optische vergroting
- Diameter vergrootglas 127 mm
- Met schroevendraaier is het armgewricht eenvoudig te verstellen en vast te maken
- Arm 830 mm
- Beschermklasse IP20
- 22W / 230V aansluiting

Order nr.	713351160
Orig. nr.	ALM3
Prijs	€ 120,00

Tappen

METALWORKS



- Set van 3 handtappen. Metriek.
- DIN352
 - Metrische schroefdraad.
 - Kwaliteit HSS - hardheid HRC 62-63
 - Voor materialen tot < 600N/mm²
 - Andere maten tot M36x4 op aanvraag.

Order nr.	Orig. nr.	Maat	Snijlengte mm	Totale lengte mm	Prijs €	
748440305	M	SKCT3M3X05HSS	3x0,5	12	40	15,50
748440407	M	SKCT3M4X07HSS	4x0,7	14	45	15,50
748440508	M	SKCT3M5X08HSS	5x0,8	16	48	15,50
748440610	M	SKCT3M6X10HSS	6x1,0	18	50	15,90
748440710	M	SKCT3M7X10HSS	7x1,0	18	50	21,50
748448125	M	SKCT3M8X125HS	8x1,25	22	56	17,90
748449125	M	SKCT3M9X125HS	9x1,25	22	63	29,50
748441015	M	SKCTM10X15HSS	10x1,5	25	70	22,50
748441115	M	SKCT3M11X15HS	11x1,5	25	70	39,50
748442175	M	SKCT3M12X175HS	12x1,75	30	75	28,50

METALWORKS



- Set van 2 handtappen. Metriek.
- DIN2181
 - Metrische schroefdraad.
 - Kwaliteit HSS - hardheid HRC 62-63
 - Voor materialen tot < 600N/mm²

Order nr.	Orig. nr.	Maat	Snijlengte mm	Totale lengte mm	Prijs €	
748413223	M	SKCTM2X04	2x0,4	11	36	6,10
748413324	M	SKCTM3X05	3x0,5	12	40	6,10
748413425	M	SKCTM4X07	4x0,7	14	45	6,10
748413526	M	SKCTM5X08	5x0,8	16	48	6,30
748413627	M	SKCTM6X075	6x0,75	18	50	7,90
748413728	M	SKCTM6X10	6x1,0	18	50	6,30
748413829	M	SKCTM7X075	7x0,75	18	50	8,70
748413930	M	SKCTM7X10	7x1,0	18	50	6,90
748414031	M	SKCTM8X075	8x0,75	22	56	7,70
748414132	M	SKCTM8X10	8x1,0	22	56	7,70
748414233	M	SKCTM8X125	8x1,25	22	56	7,10
748414334	M	SKCTM9X075	9x0,75	22	63	11,50
748414435	M	SKCTM9X10	9x1,0	22	63	11,50
748414536	M	SKCTM9X125	9x1,25	22	63	11,50
748411075	M	SKCTM10X075	10x0,75	25	70	10,50
748411102	M	SKCTM10X10	10x1,0	25	70	10,50
748411203	M	SKCTM10X125	10x1,25	25	70	10,50
748411304	M	SKCTM10X15	10x1,5	25	70	9,40
748411405	M	SKCTM11X075	11x0,75	25	80	15,50
748411506	M	SKCTM11X10	11x1,0	25	70	15,50
748411607	M	SKCTM11X125	11x1,25	25	70	15,50
748411708	M	SKCTM11X150	11x1,50	25	70	10,00
748411809	M	SKCTM12X075	12x0,75	30	75	11,50
748411910	M	SKCTM12X10	12x1,0	30	75	11,50
748412011	M	SKCTM12X125	12x1,25	30	75	11,50
748412112	M	SKCTM12X15	12x1,5	30	75	11,50
748412213	M	SKCTM12X175	12x1,75	30	75	10,50
748412314	M	SKCTM14X10	14x1,0	32	80	14,50
748412415	M	SKCTM14X125	14x1,25	32	80	14,50
748412516	M	SKCTM14X15	14x1,5	32	80	14,50
748412617	M	SKCTM14X20	14x2,0	32	80	13,50
748412718	M	SKCTM16X10	16x1,0	32	80	15,50
748412819	M	SKCTM16X15	16x1,5	32	80	15,50
748412920	M	SKCTM16X20	16x2,0	32	80	13,90
748413021	M	SKCTM18X15	18x1,5	32	80	16,50

METALWORKS



- Set van 2 handtappen BSP (GAS).
- DIN1517
 - Recht cilindrisch.
 - BSP (GAS) schroefdraad.
 - Kwaliteit HSS - hardheid HRC 62-63
 - Voor materialen tot < 600N/mm²
 - Andere maten op aanvraag G1/8", G1/4" en G3/8"

Order nr.	Orig. nr.	Maat	Snijlengte mm	Totale lengte mm	Prijs €	
748411512	M	HTBSP1/2	G1/2"x14	31	80	14,50
748411534	M	HTBSP3/4	G3/4"x14	33	90	25,90
748411510	M	748411510	G1"x11	39	100	87,90
748411514	M	HTBSP1-1/4	G1"-1/4x11	32	125	101,00
748411513	M	HTBSP1-1/2	G1"-1/2x11	32	140	133,00
748411520	M	HTBSP2	G2"x11	32	140	349,00

METALWORKS



- Handtap 1-delig BSPT
- UNI6125
 - Conisch 1:16.
 - BSPT schroefdraad.
 - Kwaliteit HSS - hardheid HRC 62-63
 - Voor materialen tot < 600N/mm²

Order nr.	Orig. nr.	Maat	Snijlengte mm	Totale lengte mm	Prijs €	
748411718	M	HTBSPT1/8	Rc 1/8"x28	15	59	12,50
748411714	M	HTBSPT1/4	Rc 1/4"x19	19	67	18,50
748411738	M	HTBSPT3/8	Rc 3/8"x19	21	75	21,50
748411712	M	HTBSPT1/2	Rc 1/2"x14	26	87	26,00
748411734	M	HTBSPT3/4	Rc 3/4"x14	28	96	75,50
748411710	M	HTBSPT1	Rc 1"x11	33	109	110,00
748411715	M	HTBSPT1-1/4	Rc 1"-1/4x11	36	119	169,00
748411716	M	HTBSPT1-1/2	Rc 1"-1/2x11	37	125	247,00
748411720	M	HTBSPT2	Rc 2"x11	41	140	369,00

METALWORKS



- HSS-G machinetap.
- Metrische schroefdraad.
 - Kwaliteit HSS-G hardheid HV 750
 - Voor staalsoorten < 700N/mm²
 - DIN 371B en DIN 376B.
 - ISO 2/6H
 - Smering vereist voor optimale prestaties.
 - Verpakt per stuk.
 - Andere maten op aanvraag tot M68x6

Order nr.	Orig. nr.	Maat	Snijlengte mm	Totale lengte mm	Diameter schacht mm	Prijs €	
747143050	M	MTBM03050	3X0,5	11	56	3,5	12,50
747144070	M	MTBM04070	4X0,7	13	63	4,5	12,50
747145080	M	MTBM05080	5X0,8	16	70	6	12,50
747146100	M	MTBM06100	6X1,0	19	80	6	12,90
747148125	M	MTBM08125	8x1,25	22	90	8	15,50
747141015	M	MTBM10150	10X1,50	24	100	10	18,50
747141217	M	MTBM12175	12X1,75	29	110	9	21,50
747141420	M	MTBM14200	14X2,00	30	110	11	26,90
747141620	M	MTBM16200	16X2,00	30	110	12	32,90
747141825	M	MTBM18250	18X2,50	34	125	14	33,50

Draadsnijkkussens

METALWORKS

Ronde draadsnijkkussens. DIN223. HSS kwaliteit. Materiaal HRC 60-61.



Gewone metrische schroefdraad en metrisch fijn.

Toepassing: metalen met een geringe hardheid tot < 600 N/mm², alu, koper en zink. Andere maten op aanvraag.

Order nr.	Maat M	Buitendiameter mm	Dikte mm	Voor kussenhouder	Prijs
					€
748431511	2x0,4	25,4	9	748420259	3,90
748431521	3x0,5	25,4	9	748420259	3,90
748431531	4x0,7	25,4	9	748420259	3,90
748431541	5x0,8	25,4	9	748420259	3,90
748431561	6x1,0	25,4	9	748420259	3,90
748431581	7x1,0	25,4	9	748420259	3,90
748431591	8x0,75	25,4	9	748420259	3,90
748431601	8x1,00	25,4	9	748420259	3,90
748431611	8x1,25	25,4	9	748420259	3,90
748431621	9x0,75	25,4	9	748420259	3,90
748431631	9x1,0	25,4	9	748420259	3,90
748431281	10x0,75	38,1	14	748423814	4,90
748431301	10x1	38,1	14	748423814	4,90
748431311	10x1,25	38,1	14	748423814	4,90
748431321	10x1,5	25,4	9	748420259	4,90
748431331	11x0,75	38,1	14	748423814	4,90
748431341	11x1,0	38,1	14	748423814	4,90
748431351	11x1,25	38,1	14	748423814	4,90
748431361	11x1,5	38,1	14	748423814	4,90
748431275	12x0,75	38,1	14	748423814	4,90
748431381	12x1,0	38,1	14	748423814	4,90
748431391	12x1,25	38,1	14	748423814	5,90
748431401	12x1,5	38,1	14	748423814	4,90
748431411	12x1,75	38,1	14	748423814	4,90
748431431	14x1,25	38,1	14	748423814	4,90
748431441	14x1,5	38,1	14	748423814	4,90
748431451	14x2,0	38,1	14	748423814	4,90
748431471	16x1,5	38,1	14	748423814	4,90
748431481	16x2,0	38,1	14	748423814	4,90
748431491	18x1,5	38,1	14	748423814	4,90

TENGOOLS



Tappen en snijkussens uit TTTD17.

Order nr.	Orig. nr.	Inhoud	Maten M	Stijging mm	Prijs €
116830100	TDD03050	Kussen	3	0,5	10,50
116830209	TDD04070	Kussen	4	0,7	10,50
116830308	TDD05080	Kussen	5	0,8	10,50
116830407	TDD06100	Kussen	6	1	10,50
116830506	TDD08125	Kussen	8	1,25	10,50
116830605	TDD10150	Kussen	10	1,5	10,50
116830704	TDD12175	Kussen	12	1,75	10,50
116831009	TDT03050	Tap	3	0,5	5,70
116831108	TDT04070	Tap	4	0,7	5,70
116831207	TDT05080	Tap	5	0,8	5,90
116831306	TDT06100	Tap	6	1	5,90
116831405	TDT08125	Tap	8	1,25	6,60
116831504	TDT10150	Tap	10	1,5	7,50
116831603	TDT12175	Tap	12	1,75	7,50

METALWORKS

Ronde draadsnijkkussens. DIN223. HSS kwaliteit. Materiaal HRC 60-61.



BSP GAS schroefdraad. (EN 24231).

Toepassing: metalen met een geringe hardheid tot < 600 N/mm², alu, koper en zink. Andere maten op aanvraag.

Order nr.	Maat	Buitendiameter mm	Dikte mm	Voor kussenhouder	Prijs
					€
748431300	1/8x28	38,1	14	748420103	7,70
748431302	1/4x19	38,1	14	748420103	7,70
748431303	3/8x19	38,1	14	748420103	7,70
748431304	1/2x14	50,8	16	748420103	14,50
748431305	3/4x14	50,8	16	748420104	14,50
748431306	1x11	63,5	19	748420104	27,50

Kussens - en tappenhouders

METALWORKS



Tappenhouder met vaste T-hendel. Korte alsook lange type. Andere groottes op aanvraag.

Order nr.	Orig. nr.	Gr.	Lengte mm	Maat	Type	Gewicht kg	Prijs €
748421203	SKCWK2	2	78	M 5-10	kort	1,00	8,60
748421204	SKCWK3	3	102	M 6-12	kort	1,00	11,50
748421211	SKCWL1	1	150	M 0-4	lang	1,00	13,90
748421212	SKCWL2	2	150	M 5-10	lang	1,00	16,50
748421213	SKCWL3	3	150	M 6-12	lang	1,00	22,50

METALWORKS



Tappenhouder met ratel. Kwaliteit staal. Korte en lange type. Voor gebruik in beperkte ruimtes.

Order nr.	Orig. nr.	Gr.	Lengte mm	Maat	Type	Gewicht kg	Prijs €
748421401	SKCTWRK1	1	85	M 3-10	kort	1,00	21,00
748421402	SKCTWRK2	2	100	M 5-12	kort	1,00	24,50
748421411	SKCTWRL1	1	250	M 3-10	lang	1,00	21,50
748421412	SKCTWRL2	2	300	M 5-12	lang	1,00	27,50

METALWORKS



Kussenhouder DIN225 (EN225568) voor ronde snijkussens. Type vast. Kwaliteit Zinklegering. Ook beschikbaar in staal op aanvraag.

Order nr.	Orig. nr.	Maat mm	Lengte mm	Maat	Gewicht kg	Prijs €
748420165 M	SKCDH165	16x5	160	M1-2.6	1,00	6,90
748420205 M	SKCDH205	20x5	165	M3-4	1,00	7,20
748420207 M	SKCDH207	20x7	185	M4.5-6	1,00	7,20
748420259 M	SKCDH259	25,4x9	215	M7-9	1,00	7,70
748423011 M	SKCDH3011	30x11	265	M10-11	1,00	12,00
748423814 M	SKCDH3814	38,1x14	315	M12-14	1,00	13,50

TENGOOLS



Wringijzer voor de Teng kussens van M3 tot M12 uit TTTD17.

Order nr.	144100104 T
Orig. nr.	DIEHNDL
Gewicht	kg 0,13
Afmetingen (l x b x h)	mm 12 x 45 x 255
Prijs	€ 8,80

METALWORKS



Verstelbare taphouder volgens DIN1814 voor tappen. Kwaliteit zinklegering. ook beschikbaar is staal op aanvraag.

Order nr.	Orig. nr.	Gr.	Lengte mm	Maat	Gewicht kg	Prijs €
748420100 M	SKCTW0	0	130	1-8	1,00	10,50
748420101 M	SKCTW1	1	188	1-10	1,00	11,50
748421112 M	SKCTW112	1 1/2	215	1-12	1,00	12,50
748420102 M	SKCTW2	2	280	4-12	1,00	18,50
748420103 M	SKCTW3	3	380	5-20	1,00	28,50

TENGOOLS



Taphouder voor de Teng tappen uit TTTD17.

Order nr.	116940107 T
Orig. nr.	TAPHNDL
Maximum vierkant opening	mm 3-12
Gewicht	kg 0,15
Prijs	€ 10,50

Schroefdraadherstelsets

METALWORKS

Schroefdraad herstelset - Metrisch - M5 tot M12.



Set speciaal voor het herstellen van schroefdraad.

Werking:

Eerst wordt de kapotte draad uitgeboord, waarna een nieuwe draad wordt getrokken en een spoel wordt geplaatst.

Andere sets op aanvraag M, BSW, BSF, UNC, UNF

Order nr.	748300201 M
Orig. nr.	SDHM5M12
Maten boren	mm 5,2 - 6,3 - 8,3 - 10,4 - 12,4
Maten draad	mm 5x0,8 - 6x1,0 - 8x1,25 - 10x1,5 - 12x1,75
Geschikt voor boor	mm 5,2 - 6,3 - 8,3 - 10,4 - 12,4
Geschikte tap	8 - 9 - 11 - 13 - 15
Aantal stuks draadcoils	25 - 25 - 25 - 25 - 10
Prijs	€ 189,00

METALWORKS



Draadinzet uit roestvrijstaal.

U plaatst de draadinzet in het geboord gat en u hebt opnieuw draad. Lengte is 1,5 x diameter. K-Coil insert inox. DIN8140.

Order nr.	Orig. nr.	Maten	VE	Prijs/VE €
748300508 M	748300508	M5x0,8	100	37,90
748300601 M	748300601	M6x1,0	100	41,90
748300125 M	748300125	M8x1,25	100	50,50
748300115 M	748300115	M10x1,5	100	75,50
748301125 M	748301125	M12x1,75	1	113,00

METALWORKS



FINE SPOED

Set draadeindhithalers "Out-you-Come" N°1-N°6. Set draadeind uithalers, hoog carbon staal, **nummers 1 tot 6**, met een bereik van M3 tot M24. spiraalvormig, fijne spoed, linkse draad, voor het verwijderen van bouten en schroeven.

Iedereen heeft wel al eens verveeld gezeten met een doorgedraaide schroef of een afgebroken bout. Wat dan? Met de "Out-you-Come" draaeind uithalers hebben wij de oplossing voor jou. De schroef of bout wordt eerst precies op de geschikte diameter voor de draaeind uithaler geboord. Vervolgens brengt u de uithaler in het gat en draait u tegen wijzerzin met behulp van een wringijzer, deze worden eveneens verkocht op onze website. De spiralen boren zich vervolgens een weg in de schroef of bout, door de linkse draad en de rechtse draaibeweging met het wringijzer, verwijdert u vervolgens de bout of schroef.

Order nr.	748529000 M
Orig. nr.	DEU16
Prijs	€ 12,90

Tappen & kussensets

METALWORKS



7-delige set van 3 in 1 combi-machinetappen.

- Metrisch M3 - M4 - M5 - M6 - M8 - M10
- Kwaliteit: HSS-G (geslepen)
- Deze machinetap combineert 3 functies in 1 beweging: boren, draadtrekken en verzinkboren.
- 1 magnetische bitshouder met 1/4 zeskantaansluiting
- Voor accu boormachines en schroevendraaiers
- Verpakt in een kunststof opbergcassette.

Order nr.	747150310		
Orig. nr.	SKC7ETM		
Aantal stuks	6		
Maten	M	3 - 4 - 5 - 6 - 8 - 10	
Prijs	€	52,00	

METALWORKS



7-delige set van HSS M2 machinetappen. DIN 371B en DIN 376B maten M3 tot M10. Verpakt in een hoogwaardige kunststof doos.

Order nr.	713051057		
Orig. nr.	MTMS7		
Aantal stuks	7		
Maten	M	3 - 4 - 5 - 6 - 8 - 10 - 12	
Prijs	€	29,90	

METALWORKS



15-delige HSS M2 set machinetappen en boren.

- Bestaande uit 7 HSS doorlopende machinetappen gaande van M3 tot M12
- Tappenhouder M3-M12
- 7 corresponderende geslepen boren voor de tappen.
- Verpakt in een hoogwaardige kunststof doos.

Order nr.	713051015		
Orig. nr.	MTMS15		
Aantal stuks	15		
Maten boren	mm	2,5 - 3,3 - 4,2 - 5,0 - 6,8 - 8,5 - 10,2	
Maten tappen	M	3 - 4 - 5 - 6 - 8 - 10 - 12	
Prijs	€	49,50	

TENGOOLS



17-delige tappen- en snijkussenset. Bestaat uit 6 tappen en 6 snijkussens gaande van M3 tot M12, 1 kussenhouder, 1 taphouder en 1 draadsnijmeter. TC-tray.

Order nr.	69190106		
Orig. nr.	TTTD17		
Maten	M3 - M4 - M5 - M6 - M8 - M10 - M12		
Prijs	€	47,50	

METALWORKS



21-delige set van HSS-G handtappen.

- Metrisch gaande van M3 - M4 - M5 - M6 - M8 - M10 - M12, DIN352.
- Kwaliteit HSS-G
- Elke tap bestaat uit een set van 3 tappen.
- Verpakt in een stevige kunststof koffer.

Order nr.	742140401		
Orig. nr.	SKC21ETM		
Aantal stuks	21		
Maten	M	3 - 4 - 5 - 6 - 8 - 10 - 12	
Prijs	€	82,90	

METALWORKS



30-delige tappen- en kussenset

Cap. M3 tot M12 Metrisch
Kwaliteit: HSS-G (geslepen)

Uitgebreid basisset met:

- 21 Handtappen DIN352 (set van 3 stuks)
M3 - M4 - M5 - M6 - M8 - M10 - M12
- 1 verstelbare taphouder 1 1/2
- 7 Corresponderende snijkussens
- 1 vaste ronde snijkussen houder ø 25x9 mm
- Verpakt in een metalen koffer.

Order nr.	742140501		
Orig. nr.	SKC30ETM		
Aantal stuks	30		
Maten tappen en kussens	M	3 - 4 - 5 - 6 - 8 - 10 - 12	
Prijs	€	115,00	

METALWORKS



40-delige kussen- en tappendoos

Metrisch
Kwaliteit: Tungsten staal

Uitgebreid basisset met:

- 17 handtappen:
M3X0,5 - M3X0,6 - M4X0,7 - M4X0,75 - M5X0,8 - M5X0,9 - M6X1,0 - M6X0,75 - M7X0,75 - M7X1,0 - M8X1,0 - M8X1,25 - M10X1,25 - M10X1,50 - M12X1,5 - M12X1,75 - 1/8"NPT
- 1 verstelbare taphouder M3-M12
- 1 taphouder kort met T hendel
- 17 bijhorende snijkussens
- 1 vaste ronde snijkussen houder ø 25.4
- 1 schroevendraaier
- 1 draadsnijkaliber
- Met degelijke inleg
- In kunststof koffer

Order nr.	748104040		
Orig. nr.	SKC40ETM		
Aantal stuks	40		
Prijs	€	35,90	



METALWORLD



110-delige kussen- en tappendoos

Cap. M2 tot M18
 Metrische maten
 Kwaliteit: Tungsten staal
 Uitgebreide basisset met:

- 70 handtappen (set van 2 stuks):
 M2X0,4 - M3X0,5 - M4X0,7 - M5X0,8 - M6X0,75 - M6X1,0
 - M7X0,75 - M7X1,0 -
 M8X0,75 - M8X1,0 - M8X1,25 - M9X0,75 - M9X1,0 - M9X1,25
 - M10X0,75 -
 M10X1,0 - M10X1,25 - M10X1,5 - M11X0,75 - M11X1,0 -
 M11X1,25 - M11X1,5 -
 M12X0,75 - M12X1,0 - M12X1,25 - M12X1,5 - M12X1,75
 - M14X1,0 - M14X1,25 -
 M14X1,5 - M14X2,0 - M16X1,0 - M16X1,5 - M16X2,0 -
 M18X1,5
- 1 verstelbare tappenhouder M6-M20
- 1 verstelbare tappenhouder M3-M12
- 1 taphouder kort met T hendel
- 35 corresponderende snijkussens
- 1 vaste ronde snijkussen houder ø 25,4
- 1 vaste ronde snijkussen houder ø 38,1
- Met degelijke inleg
- In stevige metalen doos.

Order nr.	748401100
Orig. nr.	SKC110ETM
Aantal stuks	110
Prijs	€ 99,00

METALWORLD



110-delige kussen- en tappendoos.

UNC, UNF, UNS, NPT, Metriek
 Kwaliteit: Tungsten staal

Uitgebreide basisset met:
 - 70 handtappen (set van 2 stuks):

- UNC tappen:
 No.4x40 UNC - No.6x32 UNC - No.8x32 UNC - No.10x24
 UNC - No.12x24 UNC
 1/4"x20 UNC - 5/16"x18 UNC - 3/8"x16 UNC - 7/16"x14
 UNC
 1/2"x13 UNC - 9/16"x12 UNC - 5/8"x11 UNC - 3/4"x10
 UNC

- UNF tappen:
 No.10x32 UNF - 1/4"x28 UNF - 5/16"x24 UNF - 3/8"x24
 UNF - 7/16"x20 UNF
 1/2"x20 UNF - 9/16"x18 UNF - 5/8"x18 UNF - 3/4"x16
 UNF

- UNS tappen:
 1/4"x24 UNS - 1/4"x32 UNS

- NPT tappen:
 1/8"NPT - 1/4"NPT

- Metrische tappen:
 M6X1,0 - M8X1,25 - M10X1,5 - M10X1,0 - M11X1,5 -
 M12X1,25 - M12X1,75 - M14X1,25 - M18X1,5

- 1 verstelbare tappenhouder 1/16" - 1/2"
- 1 verstelbare tappenhouder 1/4" - 3/4"
- 1 taphouder kort met T hendel
- 35 corresponderende snijkussens
- 1 vaste ronde snijkussen houder 1"
- 1 vaste ronde snijkussen houder 1 1/2"
- Met degelijke inleg
- In stevige metalen doos

Order nr.	748401200
Orig. nr.	SKC110ETS
Aantal stuks	110
Prijs	€ 109,00



Frezensets

OPTIMUM



12-delige TIN frezenset met Weldon schacht DIN1835B. Gaande van 4 tot 12mm bestaande uit 6 frezen DIN327D met 2 snijkanten en 6 frezen DIN844B met 4 snijkanten. Uitvoering met 4 snijkanten met een 30° rechtse spiraal voor betere spananafvoer voor normale tot vaste materialen. Titanium coating voor een hogere hardheid en een 2 tot 5 maal langere levensduur. Verpakt in houten kist.

Order nr.	713352113		
Orig. nr.	FSW		
Aantal stuks	12		
Frezen met 2 snijkanten	mm	4-5-6-8-10-12	
Frezen met 4 snijkanten	mm	4-5-6-8-10-12	
Prijs	€	69,00	

OPTIMUM



20-delige TIN frezenset met Weldon schacht DIN1835B. Gaande van 3 tot 20mm bestaande uit 10 frezen DIN327D met 2 snijkanten en 10 frezen DIN844B met 4 snijkanten. Uitvoering met 4 snijkanten met een 30° rechtse spiraal voor betere spananafvoer voor normale tot vaste materialen. Titanium coating voor een hogere hardheid en een 2 tot 5 maal langere levensduur. Verpakt in houten kist.

Order nr.	713386200		
Orig. nr.	FST		
Aantal stuks	20		
Frezen met 2 snijkanten	mm	3-4-5-6-8-10-12-14-18-20	
Frezen met 4 snijkanten	mm	3-4-5-6-8-10-12-14-18-20	
Prijs	€	129,00	

METALWORK



Roteerfrezenset hardmetaal 8dlg met CB spanenbreker aanslijping. Spanenbreker aanslijping is geschikt voor volgende materialen: messing, brons, koper, gietijzer, plastic, staal (60 rc), roestvrij staal tot zelfs Titanium. Cilindrische schacht ø 6 mm. Geleverd in een alu koffer met inleg.

Inhoud:

2 cilindervormige frezen met kopaanslijping: B102006, B122506
 2 cilindervormige frezen met radius einde: C061606, C102006
 2 bolvormige frezen: D100906, D121006
 2 conische frezen met radius einde: F102006 en F122506.

Order nr.	749202000		
Orig. nr.	CBSCB8		
Prijs	€	79,00	

U bewerkt alu, roestvrijstaal of andere materialen en u zoekt een specifiekere frees:

Zoals 2-, 3- en 4-lippige frezen in HSSCo8% met een speciale coating TIN, TiAlN; radiusfrezen, T-gleuf frezen, zwaluwstaartfrezen, schijffrezen, mantelkopfrezen, moduulfrezen, ect.

Wij helpen u graag verder! Zoek niet verder en stuur ons uw mail naar info@vynckier.biz met uw specifieke vraag.

Monoblok vlakfrees

OPTIMUM



Kopier- en vlakfrees. "Made in Germany". Universeel gebruik, voor bewerking van alle staal en NE-metalen. Voor vlak- en kopierfrezen. Hoge vlak- en rondloopnauwkeurigheid. Freeslichaam met verplaatste verdeling voor een bijzonder rustige loop en gelijkmatige snede. Grondlichaam en opspanschacht vormen een eenheid, waardoor kortere afstand spindel-frees en stabiele spanning. Er is geen extra freesopnamedoorn nodig. Speciale geometrie voor frezen met hoge snelheid. Economisch, daar met stompe snijvlakken het plaatje eenvoudig kan worden doorgedraaid. (tot 12 maal bruikbaar). Inclusief 5 snijplaatjes RDET 1003 MOSN 8026 en torxsleutel TX15.

Order nr.	Orig. nr.	Buitendi- ameter mm	Opname- schacht	ISO om- schrijving	Voor machine	Prijs €
713350212	M KVF02	52	MK2/M10	RD X.1003	BF20/L	229,00
713350213	M KVF03	52	MK3/M12	RD X.1003	BF30	249,00
713350214	M KVF04	52	MK4/M16	RA1003	MB4P	311,00
713350215	M KVF30	52	ISO30	RD X.1003	BF30	299,00
713350216	M KVF40	63	ISO40	RD X.1003	BF46/MF24	329,00

OPTIMUM



HM vervangplaatjes RDET 1003. MOSN8026. Positieve snijgeometrie. PVD gecoat. Voor bewerking van staal tot 900 N/mm², roestvrij staal, aluminium, non-ferro metaal, gietijzer. Geschikt voor volgende vlakfrezen (Order nr. 713350212, 713350213, 713350215, 713350216). 5 stuks.

Order nr.	713350220 M
Orig. nr.	3350220
Prijs	€ 51,50

OPTIMUM



HM Vervangplaatjes RDHT 1003 MO-FA HF7. Gepolierd. Met sterk positieve snijgeometrie. PVD gecoat. Voor bewerking van AL-legering, koperlegering, kunststoffen. Geschikt voor volgende vlakfrezen (Order nr. 713350212, 713350213, 713350215, 713350216). 5 stuks.

Order nr.	713350221 M
Orig. nr.	3350221
Prijs	€ 46,50

Sneldraaistaal HSS

METALWORKS



10-delige set sneldraaistaal HSS rond/vierkant/rechthoek L. 100 en 200 mm.

Inhoud:

- vierkant (4 stuks) 6x6x200, 8x8x200, 10x10x200, 12x12x200 mm
- rond (3 stuks) 5x100, 8x100, 12x100 mm
- rechthoekig (3 stuks) 4x8x200, 5x10x200, 6x12x200 mm.

Order nr.	790007200 M
Orig. nr.	SDS200
Type	vierkant/rechthoek/rond
Prijs	€ 79,00

Opgebraseerde beitels

OPTIMUM



11-delige beitsets met opgelaste hardmetaalplaatjes.

- Kwaliteit P20/P30.
- Volgens DIN

Order nr.	Orig. nr.	Vierkant schacht mm	Prijs €
713441008	M DBS1108	8	39,00
713441108	M DBS1110	10	49,00
713441508	M DBS1116	16	68,00
713441808	M DBS1120	20	78,50

Set draaibeitels WP

OPTIMUM



7-delige beitelset met HM-wisselplaatjes. Met titanium gecoated plaatjes (beitels 1 tot 5). Vierkant opname 8mm. Verpakt in een houten kist.

Order nr.	713441011
Orig. nr.	DBHM0708
Aantal	7
Opname mm	8
Prijs	€ 129,00

OPTIMUM



DBL1. Aparte losse beitels te verkrijgen uit beitelset DBHM0708, 713441011.

Order nr.	Orig. nr.	Beitel- nummer	ISO omschrijving	Hoogte H1	Prijs
					€
891023303	0344101101	1	SWGCR L0810 D05	8	42,00
891566736	0344101102	2	SCLCR L0810 D06	8	42,00
891023304	0344101103	3	SDJCR L0810 D07	8	42,00
891023305	0344101104	4	SDNCN L0810 D07	8	42,00
891023306	0344101105	5	SCICL L0810 D06	8	42,00
891023307	0344101106	6	LW 0810 R04	8	52,00
891023308	0344101107	7	QA 0812R L03	12	48,00

OPTIMUM



Snijplaatje T/60° TiN gecoated ISO: TCMT110204. Verpakking 5 stuks. Nr.64 - ISO TCMT110204 - T/60°

Afmetingen:
l: 10,84mm
s: 2,53mm
r: 0,40mm
d: 9,10mm
d1: 2,70mm

Order nr.	713441165
Orig. nr.	3441165
Prijs	€ 60,00

OPTIMUM



Snijplaatje. C/80° TiN gecoated ISO: CCMT060204. passend voor beitel type 2, 5, 9, 12, 29 en 63. Verpakking 5 stuks. Nr.63 - ISO CCMT060204 - C/80°

Afmetingen:
l: 6,35mm
s: 2,60mm
r: 0,40mm
d: 6,35mm
d1: 2,70mm

Order nr.	713441164
Orig. nr.	3441164
Prijs	€ 56,00

OPTIMUM



Snijplaatje. V/55° TiN gecoated ISO: DCMT070204. passend voor beitel type 3, 4, 10 en 11. Verpakking 5 stuks. Nr.65 - ISO DCMT070204 - D/55°

Afmetingen:
l: 7,30mm
s: 2,53mm
r: 0,40mm
d: 6,35mm
d1: 2,70mm

Order nr.	713441166
Orig. nr.	3441166
Prijs	€ 71,00

OPTIMUM



Afsteekplaatje. Passend voor beitel type 23 en 35. Verpakking 5 stuks.

Afmetingen:
b: 3,5mm
l: 12,14mm
fb: 0,5mm

Order nr.	713441261
Orig. nr.	3441261
Prijs	€ 8,10

OPTIMUM



Draadsnijplaatje. 60° passend voor beitel type 6, 13 en 15. Verpakking 5 stuks.

Afmetingen:
b: 3mm
l: 15mm
fb: 3mm

Order nr.	713441162
Orig. nr.	3441162
Prijs	€ 13,50



OPTIMUM



7-delige beitelset met HM-wisselplaatjes. Met titanium gecoated plaatjes. Vierkant opname 10mm. Verpakt in een houten kist.

Order nr.	713441111
Orig. nr.	DBHM0710
Aantal	7
Opname	mm 10
Prijs	€ 129,00

OPTIMUM



DBL2. Aparte losse beitels te verkrijgen uit beitelset DBHM0710, 713441111.

Order nr.	Orig. nr.	Beitel-nummer	ISO omschrijving	Hoogte H1	Prijs
					€
891023309	0344111108	8	SWGCR L1010 D05	10	46,00
891023310	0344111109	9	SCLCR L1010 E06	10	46,00
891023311	0344111110	10	SDJCR L1010 E07	10	46,00
891023312	0344111111	11	SDNCN L1010 E07	10	46,00
891023313	0344111112	12	SCICL L1010 E06	10	46,00
891023314	0344111113	13	LW 1010R L04	10	59,00
891023315	0344111114	14	QA 1012R L03	12	52,00

OPTIMUM



Snijplaatje T/60° TiN gecoated ISO: TCMT110204. Verpakking 5 stuks. Nr.64 - ISO TCMT110204 - T/60°

Afmetingen:
l: 10,84mm
s: 2,53mm
r: 0,40mm
d: 9,10mm
d1: 2,70mm

Order nr.	713441165
Orig. nr.	3441165
Prijs	€ 60,00

OPTIMUM



Snijplaatje. C/80° TiN gecoated ISO: CCMT060204. passend voor beitel type 2, 5, 9, 12, 29 en 63. Verpakking 5 stuks. Nr.63 - ISO CCMT060204 - C/80°

Afmetingen:
l: 6,35mm
s: 2,60mm
r: 0,40mm
d: 6,35mm
d1: 2,70mm

Order nr.	713441164
Orig. nr.	3441164
Prijs	€ 56,00

OPTIMUM

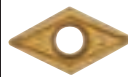

Snijplaatje. V/55° TiN gecoated ISO: DCMT070204. passend voor beitel type 3, 4, 10 en 11. Verpakking 5 stuks. Nr.65 - ISO DCMT070204 - D/55°

Afmetingen:
l: 7,30mm
s: 2,53mm
r: 0,40mm
d: 6,35mm
d1: 2,70mm

Order nr.	713441166
Orig. nr.	3441166
Prijs	€ 71,00

OPTIMUM



Afsteekplaatje. Passend voor beitel type 23 en 35. Verpakking 5 stuks.

Afmetingen:
b: 3.5mm
l: 12.14mm
fb: 0.5mm

Order nr.	713441261
Orig. nr.	3441261
Prijs	€ 8,10

OPTIMUM



Draadsnijplaatje. 60° passend voor beitel type 6, 13 en 15. Verpakking 5 stuks.

Afmetingen:
b: 3mm
l: 15mm
fb: 3mm

Order nr.	713441162
Orig. nr.	3441162
Prijs	€ 13,50

Frezen -& beitelsets

OPTIMUM



9-delige beitelset met HM-wisselplaatjes. Vierkant opname 12mm. Verpakt in een houten kist.

Order nr.	713441211
Orig. nr.	DBHM0912
Aantal	9
Opname	mm 12
Prijs	€ 159,00

OPTIMUM



DBL3. Aparte losse beitels te verkrijgen uit beitelset DBHM0912, 713441211.

Order nr.	Orig. nr.	Beitel- nummer	ISO omschrijving	Hoogte H1	Prijs
					€
891023317	M 0344121116	15	PWKNR L1012 J06	14	49,00
891023318	M 0344121117	16	PWUNR L1012 J06	13	49,00
891023319	M 0344121118	17	PSSNR L1012 J09	13	49,00
891023320	M 0344121119	18	PSSNR L1215 J09	12	49,00
891023321	M 0344121120	19	PSBNR L1215 H09	12	49,00
891023322	M 0344121121	20	PWGNR L1215 H06	12	60,00
891023323	M 0344121122	21	LW 1215R L06	12	60,00
891023324	M 0344121123	22	QA 1222R L03	17	56,00
891023316	M 0344121115	23	LN 1215R L05	12	49,00

OPTIMUM



Snijplaatje. W/80° ISO: WAUM06T300FL passend voor beitel type 16,17. Verpakking 5 stuks.

Afmetingen:
l: 6.2mm
s: 3.55mm
r: 0.14mm
d: 10.35mm
d1: 4.1mm

Order nr.	713441270
Orig. nr.	3441270
Prijs	€ 11,50

OPTIMUM



Snijplaatje. W/80° ISO: SAUM09T300FL passend voor beitel type 18. Verpakking 5 stuks.

Afmetingen:
l: 6.2mm
s: 3.55mm
r: 0.1mm
d: 10mm
d1: 4.1mm

Order nr.	713441269
Orig. nr.	3441269
Prijs	€ 11,50

OPTIMUM



Snijplaatje. W/80° ISO: WAUM06T300FR passend voor beitel type 21. Verpakking 5 stuks.

Afmetingen:
l: 6.2mm
s: 3.55mm
r: 0.1mm
d: 10.35mm
d1: 4.1mm

Order nr.	713441268
Orig. nr.	3441268
Prijs	€ 11,50

OPTIMUM



Snijplaatje. S/90° ISO: SAUM09T300F passend voor beitel type 19 en 20. Verpakking 5 stuks.

Afmetingen:
l: 10mm
s: 3.55mm
r: 0.1mm
d: 10mm
d1: 5.16mm

Order nr.	713441267
Orig. nr.	3441267
Prijs	€ 11,50

OPTIMUM



Draadsnijplaatje. 60° passend voor beitel type 22 en 34. Verpakking 5 stuks.

Afmetingen:
b: 4.7mm
l: 20mm
fb: 5mm

Order nr.	713441263
Orig. nr.	3441263
Prijs	€ 16,50

OPTIMUM



Afsteekplaatje. Passend voor beitel type 7 en 14. Verpakking 5 stuks.

Afmetingen:
b: 3.5mm
l: 12.14mm
fb: 0.5mm

Order nr.	713441161
Orig. nr.	3441161
Prijs	€ 8,20

OPTIMUM



Draadsnijplaatje. 60° passend voor beitel type 6, 13 en 15. Verpakking 5 stuks.

Afmetingen:
b: 3mm
l: 15mm
fb: 3mm

Order nr.	713441162
Orig. nr.	3441162
Prijs	€ 13,50

OPTIMUM



7-delige beitelset met HM-wisselplaatjes. Met titanium gecoated plaatjes (beitels 29 tot 33). Vierkant opname 16mm. Verpakt in een houten kist.

Order nr.	713441511
Orig. nr.	DBHM0716
Aantal	7
Opname	mm 16
Prijs	€ 169,00

OPTIMUM



DBL4. Aparte losse beitels te verkrijgen uit beitelset DBHM0716, 713441511.

Order nr.	Orig. nr.	Beitel-nummer	ISO omschrijving	Hoogte H1	Prijs
					€
891023325	0344151124	29	SLCR 1616 K06	16	52,00
891023326	0344151125	30	SSRCR 1616 H09	16	52,00
891023327	0344151126	31	SSSCR 1616 H06	16	52,00
891023328	0344151127	32	SCGCR 1616 H06	16	52,00
891023329	0344151128	33	SCGCL 1616 H06	16	52,00
891023330	0344151129	34	LW 1616R R04	16	63,00
891023331	0344151130	35	QA 1622R L03	22	59,00

OPTIMUM

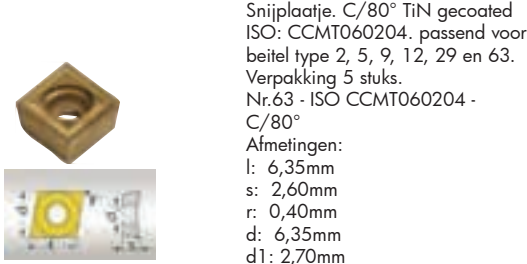

Snijplaatje. C/80° TiN gecoated ISO: CCMT060204. passend voor beitel type 2, 5, 9, 12, 29 en 63. Verpakking 5 stuks. Nr.63 - ISO CCMT060204 - C/80°
 Afmetingen:
 l: 6,35mm
 s: 2,60mm
 r: 0,40mm
 d: 6,35mm
 d1: 2,70mm

Order nr.	713441164
Orig. nr.	3441164
Prijs	€ 56,00

OPTIMUM



Snijplaatje. S/90° TiN gecoated ISO: SCMT03T304 passend voor beitel type 30 en 31. Verpakking 5 stuks.
 Afmetingen:
 l: 9.52mm
 s: 4.1mm
 r: 0.4mm
 d: 9.52mm
 d1: 4.35mm

Order nr.	713441571
Orig. nr.	3441571
Prijs	€ 62,00

OPTIMUM



Snijplaatje. C/80° TiN gecoated ISO: CCMT09T304. passend voor beitel type 32 en 33. Verpakking 5 stuks.
 Afmetingen:
 l: 9.5mm
 s: 4mm
 r: 0.4mm
 d: 9.5mm
 d1: 4.4mm

Order nr.	713441572
Orig. nr.	3441572
Prijs	€ 62,00

OPTIMUM



Draadsnijplaatje. 60° passend voor beitel type 22 en 34. Verpakking 5 stuks.
 Afmetingen:
 b: 4.7mm
 l: 20mm
 fb: 5mm

Order nr.	713441263
Orig. nr.	3441263
Prijs	€ 16,50

OPTIMUM



Afsteekplaatje. Passend voor beitel type 7 en 14. Verpakking 5 stuks.
 Afmetingen:
 b: 3.5mm
 l: 12.14mm
 fb: 0.5mm

Order nr.	713441161
Orig. nr.	3441161
Prijs	€ 8,20



OPTIMUM



7-delige beitelset met HM-wisselplaatjes. Vierkant opname 20mm. Verpakt in een houten kist.

Order nr.	713444011		
Orig. nr.	3444011		
Aantal	7		
Opname	mm	20	
Prijs	€	239,00	

OPTIMUM



DBL5. Aparte losse beitels te verkrijgen uit beitelset DBHM0720, 713444011.

Order nr.	Orig. nr.	Beitel-nummer	ISO omschrijving	Hoogte H1	Prijs
					€
891023332	0344401131	46	PWUNR L1518 M08	16	59,00
891023333	0344401132	47	PSSNR L1518 M12	16	59,00
891023334	0344401133	48	PSSNR L2020 12	22	59,00
891023335	0344401134	49	PWGN R2020 08	22	59,00
891023336	0344401135	50	PSRNR L2020 12	22	59,00
891023337	0344401136	51	LW 2020 R08	22	69,00
891023338	0344401137	52	QA 2027R L04	22	65,00

OPTIMUM



Snijplaatje. W/80° ISO: WNUM060400FL passend voor beitel type 41. Verpakking 5 stuks. Afmetingen:
l: 8.6
s: 4.5
r: 0.1
d: 13.35
d1: 5.16

Order nr.	713444073		
Orig. nr.	3444073		
Prijs	€	22,50	

OPTIMUM



Snijplaatje. W/80° ISO: WNUM060400FR passend voor beitel type 44. Verpakking 5 stuks. Afmetingen:
l: 8.6mm
s: 4.5mm
r: 0.1mm
d: 13.35mm
d1: 5.19mm

Order nr.	713444076		
Orig. nr.	3444076		
Prijs	€	22,50	

OPTIMUM



Snijplaatje. C/80° TiN gecoat ISO: CCMT09T304. passend voor beitel type 32 en 33. Verpakking 5 stuks. Afmetingen:
l: 9.5mm
s: 4mm
r: 0.4mm
d: 9.5mm
d1: 4.4

Order nr.	713441572		
Orig. nr.	3441572		
Prijs	€	62,00	

OPTIMUM



Snijplaatje. S/90° TiN gecoat ISO: SCMT03T304 passend voor beitel type 30 en 31. Verpakking 5 stuks. Afmetingen:
l: 9.52mm
s: 4.1mm
r: 0.4mm
d: 9.52mm
d1: 4.35mm

Order nr.	713441571		
Orig. nr.	3441571		
Prijs	€	62,00	

OPTIMUM



Snijplaatje. S/90° ISO: SAUM120404F passend voor beitel type 42, 43 en 45. Verpakking 5 stuks. Afmetingen:
l: 13.1mm
s: 4.5mm
r: 0.1mm
d: 13.1mm
d1: 5.16mm

Order nr.	713444075		
Orig. nr.	3444075		
Prijs	€	23,00	

OPTIMUM



Snijplaatje. S/90° ISO: SAUM120400FL passend voor beitel type 42. Verpakking 5 stuks. Afmetingen:
l: 13.1mm
s: 4.5mm
r: 0.1mm
d: 13.1mm
d1: 5.16mm

Order nr.	713444074		
Orig. nr.	3444074		
Prijs	€	22,50	

OPTIMUM



Draaibeitel set bestaande uit 5 ISO beitelhouders hoogte 16 mm, voor gebruik met ISO snijplaten, in een degelijke afsluitbare alu koffer met inleg.

- Losse draaibeitels

No.	ISO	h1
41	MVJNR 1616 H16	16 mm
42	MVVNN 1616 H16	16 mm
43	PRANN 1616 H10	16 mm
44	PRGNR 1616 H10	16 mm
45	SER 1616 H16	16 mm

- Afzonderlijke plaatjes (verpakt per 5 stuks)

No.	ISO	Ordernr.
41/43	VNMG160408 V/35°	713441701
42/44	RNMM1003MO R	713441702
45	16ERAG60 60° AR	713441703

Order nr.	713441610 M
Orig. nr.	DBHM0516
Aantal	5
Opname	mm 16
Prijs	€ 129,00

OPTIMUM



Snijplaatje. V/35° TiN gecoated ISO: VNMG160408. Verpakking 5 stuks.

Nr.41/43 - ISO VNMG160408 - V/35°

Afmetingen:

l:	15mm
s:	5.1mm
r:	0.4mm
d:	9.5mm
d1:	3.8mm



Order nr.	713441701 ##
Orig. nr.	3441701
Prijs	€ 35,00

OPTIMUM



Snijplaatje. R TiN gecoated ISO: RNMM1003MO. Verpakking 5 stuks. Nr.42/44 - ISO RNMM1003MO - R

Afmetingen:

l:	10mm
s:	3.97mm
d:	10mm
d1:	3.6mm



Order nr.	713441702 ##
Orig. nr.	3441702
Prijs	€ 29,00

OPTIMUM



Snijplaatje. 60° AR TiN gecoated ISO: 16ERAG60. Verpakking 5 stuks.

Nr.45 - ISO 16ERAG60 - 60° AR

Afmetingen:

l:	16mm
s:	3.65mm
d:	9.5mm
d1:	3.95mm

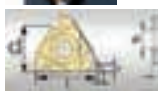

Order nr.	713441703 ##
Orig. nr.	3441703
Prijs	€ 49,00

OPTIMUM



Draaibeitel set bestaande uit 5 ISO beitelhouders hoogte 20 mm, voor gebruik met ISO snijplaten, in een degelijke afsluitbare alu koffer met inleg.

- Draaibeitels

No.	ISO	h1
53	SER 2020 K16	20 mm
54	PRGNR 2020 K10	20 mm
55	PRANN 2020 K10	20 mm
56	MVVNN 2020 K16	20 mm
57	MVJNR 2020 K16	20 mm

- Afzonderlijke plaatjes (verpakt per 5 stuks)

No.	ISO	Ordernr.
53	16ER AG60 60° AR	713441703
54/55	RNMM1003MO R	713441702
56/57	VNMG 160408 V/35°	713441701

Order nr.	713441617 M
Orig. nr.	DBHM0520
Prijs	€ 154,00

OPTIMUM

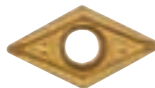

Snijplaatje. V/35° TiN gecoated ISO: VNMG160408. Verpakking 5 stuks.

Nr.41/43 - ISO VNMG160408 - V/35°

Afmetingen:

l:	15mm
s:	5.1mm
r:	0.4mm
d:	9.5mm
d1:	3.8mm



Order nr.	713441701 ##
Orig. nr.	3441701
Prijs	€ 35,00

OPTIMUM



Snijplaatje. R TiN gecoated ISO: RNMM1003MO. Verpakking 5 stuks. Nr.42/44 - ISO RNMM1003MO - R

Afmetingen:

l:	10mm
s:	3.97mm
d:	10mm
d1:	3.6mm



Order nr.	713441702 ##
Orig. nr.	3441702
Prijs	€ 29,00

OPTIMUM



Snijplaatje. 60° AR TiN gecoated ISO: 16ERAG60. Verpakking 5 stuks.

Nr.45 - ISO 16ERAG60 - 60° AR

Afmetingen:

l:	16mm
s:	3.65mm
d:	9.5mm
d1:	3.95mm



Order nr.	713441703 ##
Orig. nr.	3441703
Prijs	€ 49,00

OPTIMUM



Draaibeitel set bestaande uit 5 ISO beitelhouders hoogte 25 mm, voor gebruik met ISO snijplaten, in een degelijke afsluitbare alu koffer met inleg.

-Draaibeitels

58	MVVNN 2525 M16	25 mm
59	SER 2525 M16	25 mm
60	PRGNR 2525 M12	25 mm
61	PRANN 2525 M16	25 mm
62	MVJNR 2525 M16	25 mm

-Plaatjes voor draaibeitels (verpakt per 5 stuks)

No.	ISO	Ordernr.
58	VNMG 160408 V/35°	713441701
59	TCMT110204 T / 120°	713441163
60	RNMG1204MO R	713441705
61	RNMG1605MO R	713441704
62	VNMG 160408 V/35°	713441701

Order nr.	713441623
Orig. nr.	DBHM0525
Prijs	€ 189,00

OPTIMUM

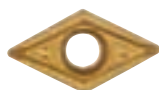

Snijplaatje. V/35° TiN gecoated ISO: VNMG160408. Verpakking 5 stuks. Nr.41/43 - ISO VNMG160408 - V/35°

Afmetingen:

l:	15mm
s:	5.1mm
r:	0.4mm
d:	9.5mm
d1:	3.8mm



Order nr.	713441701 ##
Orig. nr.	3441701
Prijs	€ 35,00

OPTIMUM



Snijplaatje. R TiN gecoated ISO: RNMG1204MO. Verpakking 5 stuks. Nr.60 - ISO RNMG1204MO - R

Afmetingen:

l:	12mm
s:	4.75mm
d:	12mm
d1:	5.1mm



Order nr.	713441705 ##
Orig. nr.	3441705
Prijs	€ 29,00

OPTIMUM



Snijplaatje. R TiN gecoated ISO: RNMG1605MO. Verpakking 5 stuks. Nr.61 - ISO RNMG1605MO - R

Afmetingen:

l:	16mm
s:	5.4mm
d:	16mm
d1:	6.3mm



Order nr.	713441704 ##
Orig. nr.	3441704
Prijs	€ 49,00

OPTIMUM



Draadsnijplaatje. 60° passend voor beitel type 22 en 34. Verpakking 5 stuks.

Afmetingen:

l:	20mm
fb:	5mm



Order nr.	713441263
Orig. nr.	3441263
Prijs	€ 16,50

OPTIMUM



Inwendige draaibeitel set bestaande uit 3 ISO beitelhouders opname diameter 10mm, voor gebruik met ISO snijplaten, in een degelijke afsluitbare alu koffer met inleg.

Beitelhouder 63: S10K SCFCR 06
Beitelhouder 64: S10K SDQCR 07
Beitelhouder 65: S10K STFCR 11

Order nr.	713441640	
Orig. nr.	IWDBS310	
Maat	mm	10
Prijs	€	59,00

OPTIMUM



Inwendige draaibeitel set bestaande uit 3 ISO beitelhouders opname diameter 12 mm, voor gebruik met ISO snijplaten, in een degelijke afsluitbare alu koffer met inleg.

Beitelhouder 63: ISO S12M SCFCR 06
Beitelhouder 64: ISO S12M SDQCR 07
Beitelhouder 65: ISO S12M STFCR 11

Order nr.	713441641	
Orig. nr.	IWDBS312	
Maat	mm	12
Prijs	€	69,00

OPTIMUM



Snijplaatje. C/80° TiN gecoated ISO: CCMT060204. passend voor beitel type 2, 5, 9, 12, 29 en 63. Verpakking 5 stuks. Nr.63 - ISO CCMT060204 - C/80°

Afmetingen:
l: 6,35mm
s: 2,60mm
r: 0,40mm
d: 6,35mm
d1: 2,70mm



Order nr.	713441164	
Orig. nr.	3441164	
Prijs	€	56,00

OPTIMUM



Snijplaatje. C/80° TiN gecoated ISO: CCMT060204. passend voor beitel type 2, 5, 9, 12, 29 en 63. Verpakking 5 stuks. Nr.63 - ISO CCMT060204 - C/80°

Afmetingen:
l: 6,35mm
s: 2,60mm
r: 0,40mm
d: 6,35mm
d1: 2,70mm



Order nr.	713441164	
Orig. nr.	3441164	
Prijs	€	56,00

OPTIMUM



Snijplaatje T/60° TiN gecoated ISO: TCMT110204. Verpakking 5 stuks. Nr.64 - ISO TCMT110204 - T/60°

Afmetingen:
l: 10,84mm
s: 2,53mm
r: 0,40mm
d: 9,10mm
d1: 2,70mm



Order nr.	713441163	
Orig. nr.	3441163	
Prijs	€	52,00

OPTIMUM



Snijplaatje T/60° TiN gecoated ISO: TCMT110204. Verpakking 5 stuks. Nr.64 - ISO TCMT110204 - T/60°

Afmetingen:
l: 10,84mm
s: 2,53mm
r: 0,40mm
d: 9,10mm
d1: 2,70mm



Order nr.	713441163	
Orig. nr.	3441163	
Prijs	€	52,00

OPTIMUM



Snijplaatje. V/55° TiN gecoated ISO: DCMT070204. passend voor beitel type 3, 4, 10 en 11. Verpakking 5 stuks. Nr.65 - ISO DCMT070204 - D/55°

Afmetingen:
l: 7,30mm
s: 2,53mm
r: 0,40mm
d: 6,35mm
d1: 2,70mm



Order nr.	713441166	
Orig. nr.	3441166	
Prijs	€	71,00

OPTIMUM

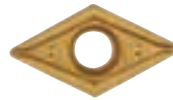

Snijplaatje. V/55° TiN gecoated ISO: DCMT070204. passend voor beitel type 3, 4, 10 en 11. Verpakking 5 stuks. Nr.65 - ISO DCMT070204 - D/55°

Afmetingen:
l: 7,30mm
s: 2,53mm
r: 0,40mm
d: 6,35mm
d1: 2,70mm



Order nr.	713441166	
Orig. nr.	3441166	
Prijs	€	71,00

OPTIMUM



Inwendige draadsnij beitel set bestaande uit 5 ISO draadsnij beitels met opnamediameters van respectievelijk 8/10/12/16/20 mm, voor gebruik met ISO snijplaten, in een degelijke afsluitbare alu koffer met inleg.

Beitelhouder 66: S10K SIR 0008 H08, diameter 8mm
 Beitelhouder 67: S10K SIR 0010 K11, diameter 10mm
 Beitelhouder 68: S10K SIR 0012 M11, diameter 12mm
 Beitelhouder 69: S10K SIR 0016 P16, diameter 16mm
 Beitelhouder 70: S10K SIR 0020 S16, diameter 20mm

Order nr.	713441650
Orig. nr.	IDRABS520
Maat	mm 8-20
Prijs	€ 149,00

OPTIMUM

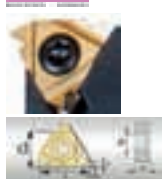

Snijplaatje.
 Nr.66 - ISO 08IR A60 60° IR
 Afmetingen:
 l: 8mm
 s: 2,22mm
 d: 4,76mm
 d1: 2,50mm
 Max. M10

Order nr.	713441725 ##
Orig. nr.	3441725
Prijs	€ 54,60

OPTIMUM

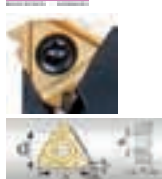

Snijplaatje.
 Nr.67-68 - ISO 11IR A60 60° IR
 Afmetingen:
 l: 11mm
 s: 3,22mm
 d: 6,35mm
 d1: 3,0mm
 Max. M12

Order nr.	713441726 ##
Orig. nr.	3441726
Prijs	€ 54,60

OPTIMUM

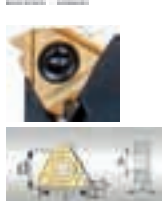

Snijplaatje.
 Nr.69-70 - ISO 16IR A60 60° IR
 Afmetingen:
 l: 16mm
 s: 3,65mm
 d: 9,50mm
 d1: 3,95mm
 Max. M16

Order nr.	713441727 ##
Orig. nr.	3441727
Prijs	€ 54,60

Wisselplaten draaibeitels

OPTIMUM



Snijplaatje T/60° TiN gecoated
 ISO: TCMT110204. Verpakking
 5 stuks.

Nr.64 - ISO TCMT110204 - T/60°
 Afmetingen:
 l: 10,84mm
 s: 2,53mm
 r: 0,40mm
 d: 9,10mm
 d1: 2,70mm



Order nr.	713441165
Orig. nr.	3441165
Prijs	€ 60,00

OPTIMUM



Snijplaatje T/60° TiN gecoated
 ISO: TCMT110204. Verpakking
 5 stuks.

Nr.64 - ISO TCMT110204 - T/60°
 Afmetingen:
 l: 10,84mm
 s: 2,53mm
 r: 0,40mm
 d: 9,10mm
 d1: 2,70mm



Order nr.	713441163
Orig. nr.	3441163
Prijs	€ 52,00

OPTIMUM



Snijplaatje. W/80° ISO:
 WNUM060400FL passend voor
 beitel type 41. Verpakking 5 stuks.

Afmetingen:
 l: 8.6
 s: 4.5
 r: 0.1
 d: 13.35
 d1: 5.16



Order nr.	713444073
Orig. nr.	3444073
Prijs	€ 22,50

OPTIMUM



Snijplaatje. W/80° ISO:
 WNUM060400FR passend voor
 beitel type 44. Verpakking 5 stuks.

Afmetingen:
 l: 8.6mm
 s: 4.5mm
 r: 0.1mm
 d: 13.35mm
 d1: 5.19mm



Order nr.	713444076
Orig. nr.	3444076
Prijs	€ 22,50

OPTIMUM



Snijplaatje. W/80° ISO:
WAUM06T300FR passend voor
beitel type 21. Verpakking 5 stuks.
Afmetingen:
l: 6.2mm
s: 3.55mm
r: 0.1mm
d: 10.35mm
d1: 4.1mm



Order nr.	713441268
Orig. nr.	3441268
Prijs	€ 11,50

OPTIMUM



Snijplaatje. W/80° ISO:
WAUM06T300FL passend voor
beitel type 16,17. Verpakking 5
stuks.
Afmetingen:
l: 6.2mm
s: 3.55mm
r: 0.14mm
d: 10.35mm
d1: 4.1mm



Order nr.	713441270
Orig. nr.	3441270
Prijs	€ 11,50

OPTIMUM



Snijplaatje. C/80° TiN gecoated
ISO: CCMT060204. passend voor
beitel type 2, 5, 9, 12, 29 en 63.
Verpakking 5 stuks.
Nr.63 - ISO CCMT060204 -
C/80°
Afmetingen:
l: 6,35mm
s: 2,60mm
r: 0,40mm
d: 6,35mm
d1: 2,70mm

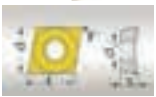

Order nr.	713441164
Orig. nr.	3441164
Prijs	€ 56,00

OPTIMUM



Snijplaatje. C/80° TiN gecoated
ISO: CCMT09T304. passend voor
beitel type 32 en 33. Verpakking
5 stuks.
Afmetingen:
l: 9.5mm
s: 4mm
r: 0.4mm
d: 9.5mm
d1: 4.4mm



Order nr.	713441572
Orig. nr.	3441572
Prijs	€ 62,00

OPTIMUM



Snijplaatje. S/90° TiN gecoated
ISO: SCMT03T304 passend voor
beitel type 30 en 31. Verpakking
5 stuks.
Afmetingen:
l: 9.52mm
s: 4.1mm
r: 0.4mm
d: 9.52mm
d1: 4.35mm



Order nr.	713441571
Orig. nr.	3441571
Prijs	€ 62,00

OPTIMUM



Snijplaatje. S/90° ISO:
SAUM09T300F passend voor
beitel type 19 en 20. Verpakking
5 stuks.
Afmetingen:
l: 10mm
s: 3.55mm
r: 0.1mm
d: 10mm
d1: 5.16mm



Order nr.	713441267
Orig. nr.	3441267
Prijs	€ 11,50

OPTIMUM



Snijplaatje. W/80° ISO:
SAUM09T300FL passend voor
beitel type 18. Verpakking 5 stuks.
Afmetingen:
l: 6.2mm
s: 3.55mm
r: 0.1mm
d: 10mm
d1: 4.1mm



Order nr.	713441269
Orig. nr.	3441269
Prijs	€ 11,50

OPTIMUM



Snijplaatje. S/90° ISO:
SAUM120404F passend voor
beitel type 42, 43 en 45.
Verpakking 5 stuks.
Afmetingen:
l: 13.1mm
s: 4.5mm
r: 0.1mm
d: 13.1mm
d1: 5.16mm



Order nr.	713444075
Orig. nr.	3444075
Prijs	€ 23,00

OPTIMUM



Snijplaatje. S/90° ISO:
SAUM120400FL passend voor
beitel type 42. Verpakking 5 stuks.
Afmetingen:
l: 13.1mm
s: 4.5mm
r: 0.1mm
d: 13.1mm
d1: 5.16mm



Order nr.	713444074 ^M
Orig. nr.	3444074
Prijs	€ 22,50

OPTIMUM



Snijplaatje. V/55° TiN geocoated
ISO: DCMT070204. passend
voor beitel type 3, 4, 10 en 11.
Verpakking 5 stuks.

Nr.65 - ISO DCMT070204 - D/55°
Afmetingen:
l: 7,30mm
s: 2,53mm
r: 0,40mm
d: 6,35mm
d1: 2,70mm



Order nr.	713441166 ^M
Orig. nr.	3441166
Prijs	€ 71,00

OPTIMUM



Afsteekplaatje. Passend voor beitel
type 7 en 14. Verpakking 5 stuks.
Afmetingen:
b: 3.5mm
l: 12.14mm
fb: 0.5mm

Order nr.	713441161 ^M
Orig. nr.	3441161
Prijs	€ 8,20

OPTIMUM



Afsteekplaatje. Passend voor beitel
type 23 en 35. Verpakking 5 stuks.
Afmetingen:
b: 3.5mm
l: 12.14mm
fb: 0.5mm

Order nr.	713441261 ^M
Orig. nr.	3441261
Prijs	€ 8,10

OPTIMUM



Afsteekplaatje. Passend voor beitel
type 47. Verpakking 5 stuks.
Afmetingen:
b: 4mm
l: 16mm
fb: 1mm

Order nr.	713444071 ^M
Orig. nr.	3444071
Prijs	€ 22,50

OPTIMUM

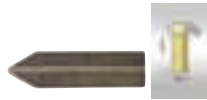

Draadsnijplaatje. 60° passend
voor beitel type 6, 13 en 15.
Verpakking 5 stuks.
Afmetingen:
b: 3mm
l: 15mm
fb: 3mm

Order nr.	713441162 ^M
Orig. nr.	3441162
Prijs	€ 13,50

OPTIMUM



Draadsnijplaatje. 60° passend voor
beitel type 22 en 34. Verpakking
5 stuks.
Afmetingen:
b: 4.7mm
l: 20mm
fb: 5mm

Order nr.	713441263 ^M
Orig. nr.	3441263
Prijs	€ 16,50

OPTIMUM



Draadsnijplaatje 60° passend voor
beitel type 46. Verpakking 5 stuks.
Afmetingen:
l: 9.5mm
s: 4mm
r: 0.4mm
d: 9.5mm
d1: 4.4

Order nr.	713444072 ^M
Orig. nr.	3444072
Prijs	€ 22,50

OPTIMUM

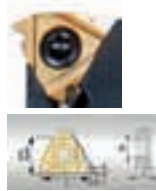

Snijplaatje.
Nr.66 - ISO 08IR A60 60° IR
Afmetingen:
l: 8mm
s: 2,22mm
d: 4,76mm
d1: 2,50mm
Max. M10

Order nr.	713441725 ##
Orig. nr.	3441725
Prijs	€ 54,60



OPTIMUM



Snijplaatje.
Nr.67-68 - ISO 11IR A60 60° IR
Afmetingen:
l: 11mm
s: 3,22mm
d: 6,35mm
d1: 3,0mm
Max. M12

Order nr.	713441726 ##
Orig. nr.	3441726
Prijs	€ 54,60

OPTIMUM



Snijplaatje.
Nr.69-70 - ISO 16IR A60 60° IR

Afmetingen:
l: 16mm
s: 3,65mm
d: 9,50mm
d1: 3,95mm
Max. M16

Order nr.	713441727 ##
Orig. nr.	3441727
Prijs	€ 54,60

OPTIMUM



Snijplaatje. V/35° TiN gecoated
ISO: VNMG160408. Verpakking 5 stuks.

Nr.41/43 - ISO VNMG160408
- V/35°
Afmetingen:
l: 15mm
s: 5.1mm
r: 0.4mm
d: 9,5mm
d1: 3.8mm

Order nr.	713441701 ##
Orig. nr.	3441701
Prijs	€ 35,00

OPTIMUM



Snijplaatje. R TiN gecoated
ISO: RNMM1003MO. Verpakking 5 stuks.

Nr.42/44 - ISO RNMM1003MO
- R
Afmetingen:
l: 10mm
s: 3.97mm
d: 10mm
d1: 3.6mm

Order nr.	713441702 ##
Orig. nr.	3441702
Prijs	€ 29,00

OPTIMUM



Snijplaatje. 60° AR TiN gecoated
ISO: 16ERAG60. Verpakking 5 stuks.

Nr.45 - ISO 16ERAG60 - 60° AR
Afmetingen:
l: 16mm
s: 3.65mm
d: 9,5mm
d1: 3.95mm

Order nr.	713441703 ##
Orig. nr.	3441703
Prijs	€ 49,00

OPTIMUM



Snijplaatje. R TiN gecoated ISO:
RNMG1204MO. Verpakking 5 stuks.

Nr.60 - ISO RNMG1204MO - R
Afmetingen:
l: 12mm
s: 4.75mm
d: 12mm
d1: 5.1mm

Order nr.	713441705 ##
Orig. nr.	3441705
Prijs	€ 29,00

OPTIMUM



Snijplaatje. R TiN gecoated ISO:
RNMG1605MO. Verpakking 5 stuks.

Nr.61 - ISO RNMG1605MO - R
Afmetingen:
l: 16mm
s: 5.4mm
d: 16mm
d1: 6.3mm

Order nr.	713441704 ##
Orig. nr.	3441704
Prijs	€ 49,00



Oliën



Hydraulische olie 32 is een hoogwaardige hydraulische olie, aanbevolen voor hydraulische systemen en tandwielkasten dat dienen te werken onder veeleisende condities. De olie heeft een breed werkspectrum in temperatuursbereik en werd ontworpen om de Scandinavische winters te overbruggen. Deze hydraulische olie voldoet en overtreft de gebruiker zijn vereisten op hoog geavanceerd hydraulische systemen. Filter gerelateerde problemen kunnen vermeden worden door deze olie en komen ook de bedrijfszekerheid ten goede. De levensduur van het ganse systeem verlengt en draagt bij tot een verlenging van de wisseltijden. MSDS fiches zijn voor professionele gebruikers beschikbaar en op aanvraag. In verpakking van 5 liter.

Order nr.	155420102	
Orig. nr.	HYDOIL 32 HVI-5L	
Viscositeit bij 40°C	mm ² /s	29,0
Viscositeit bij 100°C	mm ² /s	6,1
Index viscositeit		165
Inhoud	l	5
Prijs	€	44,50



Minerale compressor olie.

- Geschikt voor alle mobiele en stationaire zuiger- en schroefcompressoren waar een olie met een hoge viscositeit wordt aanbevolen.
- Universele olie met een breed werkspectrum.
- Met additieven die slijtage, corrosie en oxidatie voorkomen.
- De olie houdt de motor net van afzettingen en residuele afzettingen, hierdoor verlengt de levensduur van de motor en vermindert het risico van smering gerelateerde breuk aanzienlijk.
- MSDS fiche voor professionele gebruikers beschikbaar en op aanvraag.

Order nr.	155320104	
Orig. nr.	COMPOIL SAE30-1L	
Viscositeit bij 40°C	mm ² /s	98
Viscositeit bij 100°C	mm ² /s	10,5
Index viscositeit		105
Inhoud	l	1
Prijs	€	10,50



Pneumatische olie

- Deze olie is zeer geschikt voor pneumatische toestellen.
- Aanbevolen voor industrie en diverse toepassingen.
- Olie is bruikbaar in temperaturen tussen -25° en 70°.
- Deze pneumatische olie heeft betere resultaten tegen slijtage in vergelijking met de traditionele vernevelingsoliën.
- MSDS fiche voor professionelen beschikbaar en op aanvraag.

Order nr.	155310105	155310303
Orig. nr.	AIRTOIL 22-1L	AIRTOIL 22-5L
Viscositeit bij 40°C	mm ² /s	22
Viscositeit bij 100°C	mm ² /s	4,2
Index viscositeit		80
Inhoud	l	5
Prijs	€	13,50
		56,50



Geleidingsolie / lagerolie.

- Aanbevolen voor alle gereedschapswerktuigen en machines met geleidingen.
- Eveneens geschikt voor de smering van lagers en tandwielen.
- Combioil wordt speciaal aanbevolen voor machines met een hydraulisch systeem.

Voordelen:

Combioil scheidt zich gemakkelijk van water oplosbare snijoliën. Zo wordt het mengsel geleidingsolie/snijolie vermeden. Combioil vermindert bovendien behoorlijk het trillen op de geleidingen. Dit leidt tot een mooie afwerking van de oppervlakken van het eindproduct.

MSDS fiche voor professionelen beschikbaar en op aanvraag.

Order nr.	155350101	
Orig. nr.	155350101	
Viscositeit bij 40°C	mm ² /s	64
Viscositeit bij 100°C	mm ² /s	8,8
Inhoud	l	5
Densiteit bij 15°C	kg/m ³	880
ISO VG		68
Prijs	€	39,50

Koel- & snijolie





Geconcentreerde snijolie

- Om te mengen met water.
- Inzetbaar bij verspaningswerkzaamheden.
- Kan verdund worden volgens de toepassing.
Bijvoorbeeld 5% voor gewoon staal of non-ferro metalen, of 10% roestvast staal.
- Bij zware verspaningsmogelijkheden kan tot 50% olie in water gemengd worden.
- Verpakking per 2,5 liter of 10 liter

Order nr.	713601760 	713601761 
Orig. nr.	METCU025	METCU100
Inhoud	l 2,5	10
Prijs	€ 30,50	113,00





Aluminium snijwas.

- Snijwas voor non-ferro metalen zoals aluminium, koper of messing.
- De was blijft aan het werktuig gehecht, ideaal voor gebruik in moeilijk bereikbare plaatsen.
- Verleng de levensduur aanzienlijk van uw dure hardmetaal belegde cirkelzaagbladen door de alu stick te gebruiken.
- Chloorvrij.

Order nr.	713601763 
Orig. nr.	387601200
Inhoud	g 350
Prijs	€ 9,10





Aerosol Metcutspray

- Snij spray inzetbaar bij het verspanen van alle soorten metalen en ook non-ferro metalen.
- Biologisch afbreekbaar volgens CEC-L-33-T82.
- Zonder drijfgas door handpomp spray.
- Inhoud 500 ml.

Order nr.	713601762 
Orig. nr.	METUT050
Inhoud	ml 500
Prijs	€ 16,90





Koelmiddelconcentraat.

- Aquacut "B" boor- en verspaningsemulsie.
 - Mineraaloliebevattende, met water vermengbare koelsmeerstof.
 - Geschikt voor het bewerken van alle soorten metaal.
 - Normale verhouding 5 % (1:20)
 - Kleur: melkachtig wit.
 - MSDS fiche voor professionelen beschikbaar op aanvraag.
- Belangrijk: olie altijd toevoegen aan water en niet andersom.

Order nr.	713601751 
Orig. nr.	KMCS
Inhoud	l 5
Prijs	€ 59,00

Cutina



Koelvloeistof.

- Deze in water oplosbare koelvloeistof kan worden gebruikt in de meeste gevallen van zaag-, frees en slijpwerkzaamheden en in de meeste metalen.
- Geeft een homogene smeervloeistof met een prima roestbescherming.
- Aanbevolen verdunding: 3 tot 6%.

Belangrijk: olie moet altijd worden toegevoegd aan water en niet andersom.

Order nr.	155500200	
Orig. nr.	CUTFLUID5L	
Viscositeit bij 40°C	mm ² /s	88
Inhoud	l	5
Prijs	€	84,50

Cutina



Snijolie.

- Geschikt voor algemeen tot intensief zaag- en freeswerk op gereedschapsstaal, normaal staal, aluminium en koper.
- Prima smeringseigenschappen.
- Minimale nevelvorming
- Draagt bij tot een lange levensduur van het gereedschap
- Olie is licht geel van kleur.
- Verkleurt koper en zijn legeringen niet.
- MSDS fiches voor professionelen beschikbaar en op aanvraag.

Order nr.	155470206	
Orig. nr.	CUTOIL5L	
Viscositeit bij 40°C	mm ² /s	22
Inhoud	l	5
Densiteit bij 15°C	kg/m ³	900
Prijs	€	59,50

OPTIMUM



Tapolie.

- Uiterst geschikt voor draadtrekken / tappen.
- Dikkere snijolie die sterk kleeft
- Verlengt de levensduur van het gereedschap aanzienlijk
- Inhoud 1000ml.

Order nr.	713060092	
Orig. nr.	3060092	
Inhoud	l	1
Prijs	€	36,50

Koelinrichting

OPTIMUM



Universele koelinrichting.

Voor zelfmontage op de meeste metaalbewerkingsmachines. Max. hoogte 2,5 meter en toevoer van 8 liter/min.

Bestaande uit 1 koelpomp gemonteerd op het reservoir 11 l., 1 flexibele kunststof koelmiddelslang, 1 magneetvoetbevestiging voor de slang en een aanzuigslang. Geleverd met een IP-conforme schakelaar.

Opgepast: kijk naar de spanning van uw machine en maak dan pas uw keuze.

Order nr.	713352002 M	713352001 M
Orig. nr.	KME 230V	KME 400V
Spanning	V 230	3x400
Prijs	€ 219,00	239,00

OPTIMUM



Koelvloeistofvernevelaar MMC1.

Door het vernevelen van vloeistof kan u veel gericht werken en werkt u netter in de werkplaats. Grootte magnetische voet (LxBxH) 62x50x55,5 mm. Treksterkte 75 kg. Flexibele slang lengte 500 mm. Aparte vernevelolie 713606002, deze kunt u ook gebruiken voor microdoseersystemen.

Opgepast: luchtdruk noodzakelijk.

Order nr.	713356663 M
Orig. nr.	3356663
Prijs	€ 126,00

OPTIMUM



Dubbele flexibele kunststof koelvloeistofslang op magneetvoet.

Niet roestend en resistent aan de meeste oplosmiddelen en chemicaliën. Universeel toepasbaar op alle metaalbewerkingsmachines. Grootte magnetische voet (lxbxh) 60x50x55 mm, treksterkte 50 kg. Twee flexibele slangen lengte 300 mm.

Order nr.	713356660 M
Orig. nr.	DFK
Lengte	mm 335
Prijs	€ 50,50

METALWORK



Flexibele kunststof koelmiddelslang.

Order nr.	891565382 M	891565383 M	891565384 M
Orig. nr.	40413	50813	60513
Lengte	mm 2x140	2x140	2x140
Aansluiting	inch 1/4 - 1/8	3/8 - 1/2	3/4
Ronde spuitmonden	mm 1,5 - 3 - 6	6 - 9 - 12	16 - 19
Prijs	€ 33,50	39,50	49,50

Boren

METALWORKS



DIN1897



HSS-G metaalboor DIN 1897. Extra-korte uitvoering. Volledig geslepen uitvoering. Split point snijhoek 130°. Kwalitatief hoogstaande boor. De snijhoek van 130° garandeert een perfect en accuraat snijden. Ideaal voor het boren in hard staal en roestvrijstaal. Verpakt per 5 of 10 naargelang de maat. VE = verpakkingseenheid.

Order nr.	Orig. nr.	Maat mm	Snijlengte mm	VE	Prijs/VE €
742170200	DRK0200	2	12	10	7,90
742170250	DRK0250	2,5	14	10	8,80
742170300	DRK0300	3	16	10	10,90
742170325	DRK0325	3,25	18	10	11,90
742170350	DRK0350	3,5	20	10	11,90
742170375	DRK0375	3,75	20	10	13,50
742170400	DRK0400	4	22	10	13,50
742170425	DRK0425	4,25	22	10	16,50
742170450	DRK0450	4,5	24	10	15,00
742170475	DRK0475	4,75	24	10	16,90
742170500	DRK0500	5	26	10	15,50
742170525	DRK0525	5,25	26	10	22,00
742170550	DRK0550	5,5	28	10	20,50
742170575	DRK0575	5,75	28	10	24,50
742170600	DRK0600	6	28	10	23,50
742170650	DRK0650	6,5	31	10	27,90
742170700	DRK0700	7	34	10	32,50
742170750	DRK0750	7,5	34	5	17,50
742170800	DRK0800	8	37	5	20,90
742170850	DRK0850	8,5	37	5	28,00
742170900	DRK0900	9	40	5	32,00
742171000	DRK1000	10	43	5	41,50

METALWORKS



DIN338



HSS metaalboor DIN 338 gewalste uitvoering. DMO 5 staal. Zwart genitreeerd. Snijhoek 118°. Ideaal voor het boren in gietijzer, staal en aluminium. Verpakt per 5 of 10 st. naargelang de maat. VE = verpakkingseenheid.

Order nr.	Orig. nr.	Maat mm	Snijlengte mm	VE	Prijs/VE €
742121005	DRM0050	0,5	6	10	3,70
742121010	DRM0100	1	12	10	2,60
742121011	DRM0110	1,1	12	10	2,20
742123125	DRM0125	1,25	12	10	2,60
742121012	DRM0120	1,2	12	10	2,20
742121013	DRM0130	1,3	12	10	2,20
742121014	DRM0140	1,4	12	10	2,20
742121015	DRM0150	1,5	18	10	2,20
742121016	DRM0160	1,6	18	10	2,20
742121017	DRM0170	1,7	18	10	2,20

Order nr.	Orig. nr.	Maat mm	Snijlengte mm	VE	Prijs/VE €
742121175	DRM0175	1,75	18	10	2,60
742121018	DRM0180	1,8	18	10	2,20
742121019	DRM0190	1,9	18	10	2,20
742121020	DRM0200	2	24	10	2,20
742121021	DRM0210	2,1	24	10	2,40
742121022	DRM0220	2,2	24	10	2,40
742121225	DRM0225	2,25	30	10	3,10
742121023	DRM0230	2,3	24	10	2,40
742121024	DRM0240	2,4	24	10	2,40
742121025	DRM0250	2,5	30	10	2,40
742121026	DRM0260	2,6	30	10	2,40
742121027	DRM0270	2,7	30	10	2,40
742121275	DRM0275	2,75	30	10	3,10
742121028	DRM0280	2,8	30	10	2,40
742121029	DRM0290	2,9	30	10	2,40
742121030	DRM0300	3	33	10	2,40
742121031	DRM0310	3,1	33	10	2,90
742121032	DRM0320	3,2	33	10	2,90
742121325	DRM0325	3,25	33	10	3,50
742121033	DRM0330	3,3	33	10	2,90
742121034	DRM0340	3,4	33	10	2,90
742121035	DRM0350	3,5	39	10	2,90
742121036	DRM0360	3,6	39	10	2,90
742121375	DRM0375	3,75	39	10	3,50
742121038	DRM0380	3,8	39	10	2,90
742121039	DRM0390	3,9	39	10	2,90
742121040	DRM0400	4	43	10	2,90
742121041	DRM0410	4,1	43	10	4,00
742121042	DRM0420	4,2	43	10	4,00
742121425	DRM0425	4,25	43	10	4,80
742121043	DRM0430	4,3	43	10	4,00
742121044	DRM0440	4,4	43	10	4,00
742121045	DRM0450	4,5	47	10	4,00
742121046	DRM0460	4,6	47	10	4,00
742121047	DRM0470	4,7	47	10	4,00
742121475	DRM0475	4,75	47	10	4,80
742121048	DRM0480	4,8	47	10	4,00
742121049	DRM0490	4,9	47	10	4,00
742121050	DRM0500	5	52	10	4,00
742121051	DRM0510	5,1	52	10	5,20
742121052	DRM0520	5,2	52	10	5,20
742121525	DRM0525	5,25	52	10	6,50
742121053	DRM0530	5,3	52	10	5,20
742121054	DRM0540	5,4	52	10	5,20
742121055	DRM0550	5,5	57	10	5,20
742121056	DRM0560	5,6	57	10	5,20
742121057	DRM0570	5,7	57	10	5,20
742121575	DRM0575	5,75	57	10	6,50
742121058	DRM0580	5,8	57	10	5,20
742121059	DRM0590	5,9	57	10	5,20
742121060	DRM0600	6	57	10	5,20
742121061	DRM0610	6,1	57	10	6,90
742121062	DRM0620	6,2	57	10	6,90
742121625	DRM0625	6,25	57	10	8,00
742121065	DRM0650	6,5	63	10	6,90
742121067	DRM0670	6,7	63	10	8,20
742121700	DRM0675	6,75	63	10	9,70
742121068	DRM0680	6,8	63	10	8,20
742121069	DRM0690	6,9	63	10	8,20
742121070	DRM0700	7	69	10	8,20
742121071	DRM0710	7,1	69	5	4,60
742121072	DRM0720	7,2	69	5	4,60
742121725	DRM0725	7,25	69	5	5,60
742121073	DRM0730	7,3	69	5	4,60
742121074	DRM0740	7,4	69	5	4,60
742121075	DRM0750	7,5	69	5	4,60
742121076	DRM0760	7,6	69	5	4,80
742121077	DRM0770	7,7	69	5	4,80
742121775	DRM0775	7,75	69	5	5,90
742121079	DRM0790	7,9	69	5	4,80

Order nr.	Orig. nr.	Maat mm	Snijlengte mm	VE	Prijs/VE €
742121080	DRM0800	8	75	5	4,80
742121081	DRM0810	8,1	75	5	5,90
742121082	DRM0820	8,2	75	5	5,90
742121825	DRM0825	8,25	75	5	7,00
742121084	DRM0840	8,4	75	5	5,90
742121085	DRM0850	8,5	75	5	5,90
742121086	DRM0860	8,6	75	5	6,50
742121087	DRM0870	8,7	75	5	6,50
742121875	DRM0875	8,75	75	5	7,70
742121088	DRM0880	8,8	75	5	6,50
742121089	DRM0890	8,9	75	5	6,50
742121090	DRM0900	9	81	5	6,50
742121091	DRM0910	9,1	81	5	7,50
742121092	DRM0920	9,2	81	5	7,50
742121925	DRM0925	9,25	81	5	8,90
742121093	DRM0930	9,3	81	5	7,50
742121094	DRM0940	9,4	81	5	7,50
742121095	DRM0950	9,5	81	5	7,50
742121096	DRM0960	9,6	81	5	7,50
742121097	DRM0970	9,7	81	5	7,50
742121975	DRM0975	9,75	81	5	8,90
742121098	DRM0980	9,8	81	5	7,50
742121099	DRM0990	9,9	81	5	7,50
742121100	DRM1000	10	87	5	7,50
742122025	DRM1025	10,25	87	5	11,00
742121105	DRM1050	10,5	87	5	9,30
742122075	DRM1075	10,75	87	5	12,50
742121110	DRM1100	11	94	5	10,50
742122125	DRM1125	11,25	94	5	12,50
742121115	DRM1150	11,5	94	5	10,90
742122175	DRM1175	11,75	94	5	13,50
742121120	DRM1200	12	101	5	11,50
742122225	DRM1225	12,25	101	5	15,50
742121125	DRM1250	12,5	101	5	13,50
742122275	DRM1275	12,7	101	5	16,50
742121130	DRM1300	13	101	5	14,50
742121135	DRM1350	13,5	108	3	11,50
742121140	DRM1400	14	108	3	12,50
742121145	DRM1450	14,5	114	3	13,90
742121150	DRM1500	15	114	3	19,00
742121155	DRM1550	15,5	120	3	20,90
742121160	DRM1600	16	120	3	22,90

Order nr.	Orig. nr.	Maat mm	Snijlengte mm	Schacht mm	VE	Prijs/VE €
742131350	DRMS1350	13,5	108	13	3	15,00
742131400	DRMS1400	14	108	13	3	16,50
742131450	DRMS1450	14,5	114	13	3	17,90
742131500	DRMS1500	15	114	13	3	24,50
742131550	DRMS1550	15,5	120	13	3	27,00
742131600	DRMS1600	16	120	13	3	29,50
742131650	DRMS1650	16,5	125	13	1	10,50
742131700	DRMS1700	17	125	13	1	11,00
742131750	DRMS1750	17,5	130	13	1	11,50
742131800	DRMS1800	18	130	13	1	12,50
742131850	DRMS1850	18,5	135	13	1	12,90
742131900	DRMS1900	19	135	13	1	13,50
742131950	DRMS1950	19,5	140	13	1	13,90
742132000	DRMS2000	20	140	13	1	14,50

METAL WORKS



HSS-G metaalboor DIN 338. Volledig geslepen uitvoering. Blanke uitvoering. Split point snijhoek 130°. De snijhoek van 130° garandeert een perfect en accuraat snijden. Ideaal voor het boren in staal en roestvrijstaal. Verpakt per 5 of 10 naargelang de maat. VE = verpakkingseenheid.

Order nr.	Orig. nr.	Maat mm	Snijlengte mm	VE	Prijs/VE €
742101005	DRG0050	0,5	6	10	19,50
742101010	DRG0100	1	12	10	11,00
742101015	DRG0150	1,5	18	10	10,50
742101020	DRG0200	2	24	10	8,50
742101025	DRG0250	2,5	30	10	9,40
742101026	DRG0260	2,6	30	10	10,50
742101030	DRG0300	3	33	10	9,70
742101033	DRG0330	3,3	36	10	12,50
742101035	DRG0350	3,5	39	10	11,90
742101040	DRG0400	4	43	10	12,50
742101041	DRG0410	4,1	43	10	16,00
742101042	DRG0420	4,2	43	10	16,00
742101045	DRG0450	4,5	47	10	14,50
742101050	DRG0500	5	52	10	15,90
742101055	DRG0550	5,5	57	10	24,50
742101060	DRG0600	6	57	10	21,90
742101065	DRG0650	6,5	63	10	28,00
742101068	DRG0680	6,8	69	10	35,50
742101070	DRG0700	7	69	10	32,50
742101075	DRG0750	7,5	69	5	17,50
742101080	DRG0800	8	75	5	20,90
742101085	DRG0850	8,5	75	5	25,50
742101090	DRG0900	9	81	5	26,50
742101095	DRG0950	9,5	81	5	27,90
742101100	DRG1000	10	87	5	29,90
742101102	DRG1025	10,25	87	5	42,50
742101105	DRG1050	10,5	87	5	37,50
742101110	DRG1100	11	94	5	44,50
742101150	DRG1150	11,5	94	5	47,50
742101120	DRG1200	12	101	5	51,50
742101125	DRG1250	12,5	101	5	56,00
742101130	DRG1300	13	101	5	59,90

METAL WORKS



HSS rolgewalste metaalboor DIN 338. Met 10mm of 13mm afgedraaide schacht voor kleine boorhouders. Zwart genitreeerde uitvoering. Deze boor laat toe om grotere diameters te boren met een boormachine uitgerust met een 13mm capaciteit boorhouder. Verpakt per 3 of 5 naargelang de maat. VE = verpakkingseenheid.

Order nr.	Orig. nr.	Maat mm	Snijlengte mm	Schacht mm	VE	Prijs/VE €
742131105	DRMS1050	10,5	87	10	5	12,50
742131100	DRMS1100	11	94	10	5	13,50
742131150	DRMS1150	11,5	94	10	5	11,90
742131200	DRMS1200	12	101	10	5	14,90
742131250	DRMS1250	12,5	101	10	5	1,40
742131300	DRMS1300	13	101	10	5	18,50

METALWORKS



HSS-Co 5% geslepen metaalboor DIN 338. Blanke uitvoering in hoge kwaliteit. Split point slijhoek 130°. De slijhoek van 130° garandeert een perfect en accuraat snijden. Ideaal voor het boren in hard staal en roestvrijstaal. Verpakt in een individuele self service verpakking. Per stuk.

8% cobalt op bestelling leverbaar.

Order nr.	Orig. nr.	Maat mm	Snijlengte mm	Prijs €
742090100	DRCO100C	1	12	1,80
742090150	DRCO150C	1,5	18	2,00
742090200	DRCO200C	2	24	1,90
742090250	DRCO250C	2,5	30	2,00
742090300	DRCO300C	3	33	2,00
742090350	DRCO350C	3,5	39	2,30
742090400	DRCO400C	4	43	3,00
742090450	DRCO450C	4,5	47	3,00
742090500	DRCO500C	5	52	2,90
742090550	DRCO550C	5,5	57	3,70
742090600	DRCO600C	6	57	3,70
742090650	DRCO650C	6,5	63	4,80
742090700	DRCO700C	7	69	5,60
742090750	DRCO750C	7,5	69	5,60
742090800	DRCO800C	8	75	6,70
742090850	DRCO850C	8,5	75	7,00
742090900	DRCO900C	9	81	8,50
742090950	DRCO950C	9,5	81	9,00
742091000	DRCO1000C	10	87	9,90
742091100	DRCO1100C	11	94	14,50
742091200	DRCO1200C	12	101	16,50
742091300	DRCO1300C	13	101	18,50

METALWORKS



HSS-Co 5% geslepen metaalboor DIN 338. Blanke uitvoering in hoge kwaliteit. Split point slijhoek 130°. De slijhoek van 130° garandeert een perfect en accuraat snijden. Ideaal voor het boren in hard staal en roestvrijstaal. Verpakt per 5 of 10 naargelang de maat. VE = verpakkingseenheid.

8% cobalt op bestelling leverbaar.

Order nr.	Orig. nr.	Maat mm	Snijlengte mm	VE	Prijs/VE €
742080100	DRCO100	1	12	10	10,90
742080125	DRCO125	1,25	16	10	13,50
742080150	DRCO150	1,5	18	10	12,50
742080175	DRCO175	1,75	22	10	12,50
742080200	DRCO200	2	24	10	11,00
742080225	DRCO225	2,25	27	10	13,50
742080250	DRCO250	2,5	30	10	12,50
742080275	DRCO275	2,75	33	10	13,50
742080300	DRCO300	3	33	10	12,50
742080325	DRCO325	3,25	36	10	16,50
742080350	DRCO350	3,5	39	10	14,90
742080375	DRCO375	3,75	39	10	18,50
742080400	DRCO400	4	43	10	16,50

Order nr.	Orig. nr.	Maat mm	Snijlengte mm	VE	Prijs/VE €
742080425	DRCO425	4,25	43	10	20,50
742080450	DRCO450	4,5	47	10	18,90
742080475	DRCO475	4,75	47	10	22,50
742080500	DRCO500	5	52	10	20,50
742080525	DRCO525	5,25	52	10	30,50
742080550	DRCO550	5,5	57	10	27,50
742080575	DRCO575	5,75	57	10	30,50
742080600	DRCO600	6	57	10	27,50
742080650	DRCO650	6,5	63	10	37,50
742080700	DRCO700	7	69	10	45,50
742080750	DRCO750	7,5	69	5	22,50
742080800	DRCO800	8	75	5	27,50
742080850	DRCO850	8,5	75	5	28,90
742080900	DRCO900	9	81	5	35,50
742080950	DRCO950	9,5	81	5	38,50
742081000	DRCO1000	10	87	5	42,00
742081050	DRCO1050	10,5	87	5	52,90
742081100	DRCO1100	11	94	5	61,90
742081150	DRCO1150	11,5	94	5	64,50
742081200	DRCO1200	12	101	5	71,50
742081250	DRCO1250	12,5	101	5	78,50
742081300	DRCO1300	13	101	5	79,90

METALWORKS



HSS-G metaalboor DIN 340. Lange uitvoering. Volledig geslepen uitvoering. Split point slijhoek 130°. Kwalitatief hoogstaande boor. De slijhoek van 130° garandeert een perfect en accuraat snijden. Ideaal voor het boren in hard staal en roestvrijstaal. Verpakt per 5 of 10 naargelang de maat. VE = verpakkingseenheid.

Order nr.	Orig. nr.	Maat mm	VE	Prijs/VE €
742180200	DRL0200	2	10	19,90
742180250	DRL0250	2,50	10	20,90
742180300	DRL0300	3	10	24,50
742180325	DRL0325	3,25	10	26,50
742180350	DRL0350	3,50	10	25,50
742180375	DRL0375	3,75	10	27,50
742180400	DRL0400	4	10	26,50
742180425	DRL0425	4,25	10	33,50
742180450	DRL0450	4,50	10	33,50
742180475	DRL0475	4,75	10	34,50
742180500	DRL0500	5	10	32,50
742180525	DRL0525	5,25	10	45,50
742180550	DRL0550	5,50	10	45,50
742180575	DRL0575	5,75	10	49,50
742180600	DRL0600	6	10	49,50
742180650	DRL0650	6,50	5	26,50
742180700	DRL0700	7	5	29,90
742180750	DRL0750	7,50	5	35,00
742180800	DRL0800	8	5	39,90
742180850	DRL0850	8,50	5	55,00
742180900	DRL0900	9	5	57,50
742180950	DRL0950	9,50	5	61,50
742181000	DRL1000	10	5	60,90
742181050	DRL1050	10,50	5	73,50
742181100	DRL1100	11	5	74,50
742181150	DRL1150	11,50	5	82,50
742181200	DRL1200	12	5	89,50
742181250	DRL1250	12,50	5	92,50
742181300	DRL1300	13	5	109,00



METALWORKS



HSS metaalboor DIN 345 met conische schacht. Voor gebruik bij boormachines met conische schachtopening. Zwart genitreerde uitvoering. Snijhoek 118°. Verpakt per stuk.
 Grotere maten tot 60 mm op aanvraag leverbaar.

Order nr.	Orig. nr.	Maat mm	Snijlengte mm	Aansluiting MK	Prijs €
748231001	STWMT11100	11	94	1	7,10
748231102	STWMT11150	11,5	94	1	7,50
748231203	STWMT11200	12	101	1	7,50
748231304	STWMT11250	12,5	101	1	7,90
748231405	STWMT11300	13	101	1	7,90
748231506	STWMT11350	13,5	101	1	9,70
748231607	STWMT11400	14	108	1	9,70
748231708	STWMT21450	14,5	108	2	11,50
748231809	STWMT21500	15	114	2	11,50
748231910	STWMT21550	15,5	114	2	11,50
748232011	STWMT21600	16	120	2	11,50
748232112	STWMT21650	16,5	120	2	13,50
748232213	STWMT21700	17	125	2	13,50
748232314	STWMT21750	17,5	125	2	14,50
748232415	STWMT21800	18	130	2	14,50
748232516	STWMT21850	18,5	130	2	14,90
748232617	STWMT21900	19	135	2	14,90
748232718	STWMT21950	19,5	135	2	15,50
748232819	STWMT22000	20	140	2	15,50
748232920	STWMT22050	20,5	140	2	19,50
748233021	STWMT22100	21	145	2	19,50
748233122	STWMT22150	21,5	145	2	20,50
748233223	STWMT22200	22	150	2	20,50
748233324	STWMT22250	22,5	150	2	22,90
748233425	STWMT22300	23	155	2	22,90
748233526	STWMT32350	23,5	155	3	26,00
748233627	STWMT32400	24	160	3	26,00
748233728	STWMT32450	24,5	160	3	27,50
748233829	STWMT32500	25	160	3	27,50
748233930	STWMT32550	25,5	160	3	31,50
748234031	STWMT32600	26	165	3	31,50
748234132	STWMT32650	26,5	165	3	32,50
748234233	STWMT32700	27	170	3	32,50
748234334	STWMT32750	27,5	170	3	34,50
748234435	STWMT32800	28	170	3	34,50
748234536	STWMT32850	28,5	170	3	37,50
748234637	STWMT32900	29	175	3	37,50
748234738	STWMT32950	29,5	175	3	40,50
748234839	STWMT33000	30	175	3	40,50
748234940	STWMT33050	30,5	175	3	45,50
748235041	STWMT33100	31	180	3	41,50
748235142	STWMT33150	31,5	180	3	53,50
748235243	STWMT43200	32	185	4	69,50
748235344	STWMT43250	32,5	185	4	69,50
748235445	STWMT43300	33	185	4	77,00
748235546	STWMT43350	33,5	185	4	77,00
748235647	STWMT43400	34	190	4	81,50
748235748	STWMT43450	34,5	190	4	81,50
748235849	STWMT43500	35	190	4	90,00
748235950	STWMT43550	35,5	190	4	89,00
748236051	STWMT43600	36	195	4	115,00
748236152	STWMT43650	36,5	195	4	103,00
748236253	STWMT43700	37	195	4	103,00
748236455	STWMT43800	38	200	4	120,00

Order nr.	Orig. nr.	Maat mm	Snijlengte mm	Aansluiting MK	Prijs €
748236657	STWMT43900	39	200	4	120,00
748236859	STWMT44000	40	200	4	120,00

METALWORKS



Professionele steenboor DIN 8039. Standaard lengte, snijhoek 130°. Hoogwaardige geslepen uitvoering met platte snijtop geschikt voor klopboormachines. Ideaal voor het boren in stenen, beton en marmer. Verpakt per stuk.

Order nr.	Orig. nr.	Maat mm	Snijlengte mm	Totale lengte mm	Prijs €
742060400	DRB0400C	4	40	75	2,80
742060500	DRB0500C	5	45	85	2,90
742060600	DRB0600C	6	55	100	2,90
742060800	DRB0800C	8	65	100	3,70
742060900	DRB0900C	9	65	110	4,10
742061000	DRB1000C	10	65	120	4,30
742061200	DRB1200C	12	85	150	5,90
742061400	DRB1400C	14	85	150	10,00
742061600	DRB1600C	16	85	150	13,50
742061800	DRB1800C	18	89	160	15,50
742062000	DRB2000C	20	89	160	16,50

METALWORKS



Professionele steenboor DIN 8039. Lange versie. Hoogwaardige geslepen uitvoering met platte snijtop geschikt voor klopboormachines. Ideaal voor het boren in stenen, beton en marmer. Verpakt per stuk.

Order nr.	Orig. nr.	Maat mm	Totale lengte mm	Prijs €
742061505	DRBL1505C	5	150	4,10
742061506	DRBL1506C	6	150	4,60
742062008	DRBL2008C	8	150	5,70
742062010	DRBL20010C	10	200	7,00
742062012	DRBL20012C	12	200	8,80
742064006	DRBL4006C	6	400	9,00
742064008	DRBL4008C	8	400	9,00
742064010	DRBL40010C	10	400	10,90
742064012	DRBL40012C	12	400	13,50

METALWORKS



Steenboor SDS-PLUS. Hoogwaardige geslepen uitvoering met speciale platte snijtip geschikt voor klopbormachines. Voor professioneel gebruik. Voorzien van de zelfspannende SDS-PLUS koppeling. Ideaal voor het boren in stenen, beton en marmer. Verpakt per stuk.

Order nr.	Orig. nr.	Maat mm	Lengte mm	Prijs €
742001105	DSDS11005	5	110	3,00
742001106	DSDS11006	6	110	3,10
742001107	DSDS11007	7	110	3,40
742001108	DSDS11008	8	110	3,30
742001110	DSDS11010	10	110	3,90
742001605	DSDS16005	5	160	3,30
742001606	DSDS16006	6	160	3,40
742001608	DSDS16008	8	160	3,70
742001610	DSDS16010	10	160	4,20
742001612	DSDS16012	12	160	4,40
742001614	DSDS16014	14	160	6,10
742001616	DSDS16016	16	160	8,20
742002106	DSDS21006	6	210	4,30
742002108	DSDS21008	8	210	4,70
742002110	DSDS21010	10	210	5,10
742002112	DSDS21012	12	210	6,10
742002114	DSDS21014	14	210	7,10
742002116	DSDS21016	16	210	9,00
742002118	DSDS21018	18	210	11,00

METALWORKS



Speedmaster speciaal geslepen metaalboor DIN 338. Blanke uitvoering. Speciale slijpmethode waardoor een hogere slijpwaliteit wordt bereikt dan de klassieke geslepen uitvoering. De snijtip is voorzien van 3 platte hoeken voor een perfecte snit. Industrieel toepassingsveld. Verpakt per 5 of 10 naargelang de maat. VE = verpakkingseenheid.

Order nr.	Orig. nr.	Maat mm	VE	Prijs/VE €
742070100	DRSM0100	1	10	13,50
742070150	DRSM0150	1,5	10	13,50
742070200	DRSM0200	2	10	13,50
742070250	DRSM0250	2,5	10	13,50
742070300	DRSM0300	3	10	14,50
742070350	DRSM0350	3,5	10	16,90
742070400	DRSM0400	4	10	18,50
742070450	DRSM0450	4,5	10	20,50
742070500	DRSM0500	5	10	24,00
742070550	DRSM0550	5,5	10	30,50
742070600	DRSM0600	6	10	32,50
742070650	DRSM0650	6,5	10	38,00
742070700	DRSM0700	7	10	44,50
742070750	DRSM0750	7,5	5	23,90
742070800	DRSM0800	8	5	29,50
742070850	DRSM0850	8,5	5	31,50
742070900	DRSM0900	9	5	36,50

Order nr.	Orig. nr.	Maat mm	VE	Prijs/VE €
742070950	DRSM0950	9,5	5	39,50
742071000	DRSM1000	10	5	45,50
742071050	DRSM1050	10,5	5	49,50
742071100	DRSM1100	11	5	55,50
742071150	DRSM1150	11,5	5	60,50
742071200	DRSM1200	12	5	69,50
742071250	DRSM1250	12,5	5	74,50
742071300	DRSM1300	13	5	79,50

METALWORKS



HSS Centerboren DIN333A. Snijhoek 60°. Verpakt per stuk.

Order nr.	Orig. nr.	Maat mm	Lengte mm	D mm	Prijs €
748240100	DRCD0100	1	31,5	3,15	6,20
748240160	DRCD0160	1,6	35,5	4	6,10
748240200	DRCD0200	2	40	5	6,50
748240250	DRCD0250	2,5	45	6	6,90
748240315	DRCD0315	3,15	50	6,3	8,00
748240400	DRCD0400	4	56	8	15,50
748240500	DRCD0500	5	63	10	21,00
748240630	DRCD0630	6,3	71	16	32,50

METALWORKS



HSS verzinkboren 3 tanden op 90°, volgens DIN 335-C. Met cilindrische schacht. Verpakt per stuk.

Order nr.	Orig. nr.	Maat mm	Prijs €
748279015	748279015	15	25,50
748279063	748279063	6,3	14,50
748279073	748279073	7,3	16,50
748279083	748279083	8,3	16,50
748279094	748279094	9,4	18,50
748279104	748279104	10,4	20,00
748279124	748279124	12,4	21,50
748279165	748279165	16,5	26,50
748279205	748279205	20,5	36,50

METALWORKS



HSS trapboren. Met cilindrische schacht. Verpakt per stuk.

Order nr.	Orig. nr.	Maat mm	Trappen mm	Type	Prijs €
748280101	7482800101	4-12	5	1	25,90
748280102	DRSD2	4-12	9	2	28,50
748280104	DRSD4	4-20	9	4	37,90
748280106	DRSD6	4-30	13	6	79,90
748280103	748280103	12-20	9	3	73,50
748280105	748280105	20-30	11	5	116,00
748280124	DRSD24	6-38	-	24	134,00
748280109	DRSD9	6-36	-	9	172,00

METALWORKS



HSS Conische trapboren. Verpakt per stuk.

Order nr.	Orig. nr.	Maat mm	Type	Prijs €
748320010 M	DRSDC1	3-14	1	19,50
748320020 M	DRSDC2	6-20	2	32,50
748320030 M	DRSDC3	16-30,5	3	59,50
748320040 M	DRSDC4	26-40	4	129,00
748320070 M	DRSDC7	3-31	7	92,50

METALWORKS



Puntlasfrees HSS-Co voor pneumatische toepassingen. Met geharde punt om door puntlassen te kunnen boren.

Order nr.	Orig. nr.	Maat mm	Prijs €
748310650 M	DRSPCO65	6,5	17,00
748310800 M	DRSPCO80	8	19,50
748310810 M	748310810	8 vario	19,50

METALWORKS



Puntlasboor volgens DIN1897 met aangepaste punt DIN1412/E. Kwaliteit HSS Cobalt. Speciale boren voor het boren op laspunten.

Order nr.	Orig. nr.	Maat mm	Totale lengte mm	Prijs €
748297106 M	DRSP06	6	68	14,90
748297107 M	DRSP07	7	74	16,50
748297108 M	DRSP08	8	79	17,50
748297110 M	DRSP10	10	89	22,50

METALWORKS



Puntlasfrees HSS-CO+TIN.

Order nr.	Orig. nr.	Maat mm	Prijs €
748311650 M	DRSPT165	6,5	21,50
748311800 M	DRSPT180	8	24,50
748311810 M	748311810	8 vario	24,50

Borenssets

METALWORKS



Borensset, rolgewalst, DIN338-R type N, kwaliteitstaal HSS, zwarte uitvoering, 118°, met een kruisaanslijping vanaf 2 mm. Keuze uit 19dlg van 1 tot 10 mm opgaande per 0.5 mm of 25dlg van 1 tot 13 mm opgaand per 0.5 mm. Verpakt in een hoogwaardige kunststof doos.

Wat zijn de voordelen van kruisaanslijping?

- Voorboren is niet noodzakelijk
- Betere centering en hogere precisie.
- Kleinere verspaningskrachten.
- Betere spananafvoer door spanendeling.

Order nr.	742120019 M	742120025 M
Orig. nr.	DRMS19	DRMS25
Aantal stuks	19	25
Opgaand	mm per 0,5	per 0,5
Maten	mm 1-10	1-13
Prijs	€ 13,90	25,90

METALWORKS



Borensset, volledig geslepen, DIN338-G type N, kwaliteitstaal HSS, blanke uitvoering, 118°, met een kruisaanslijping vanaf 2 mm. Keuze uit 19dlg van 1 tot 10 mm opgaande per 0.5 mm of 25dlg van 1 tot 13 mm opgaand per 0.5 mm. Verpakt in een hoogwaardige kunststof doos.

Wat zijn de voordelen van kruisaanslijping?

- Voorboren is niet noodzakelijk
- Betere centering en hogere precisie.
- Kleinere verspaningskrachten.
- Betere spananafvoer door spanendeling.

Order nr.	742161900 M	742162500 M
Orig. nr.	DRGS19	DRGS25
Aantal stuks	19	25
Opgaand	mm per 0,5	per 0,5
Maten	mm 1-10	1-13
Prijs	€ 19,90	39,00



METALWORK



Borenset, volledig geslepen, DIN338-G type N, kwaliteitstaal HSS, blanke uitvoering, 118°, met een kruisaanslijping vanaf 2 mm. 170 dlg van 1 tot 10 mm opgaande per 0.5 mm per 10 stuks. Verpakt in een hoogwaardige metalen koffer met overzichtelijke inleg met maataanduiding.

Wat zijn de voordelen van kruisaanslijping?

- Voorboren is niet noodzakelijk
- Betere centrering en hogere precisie.
- Kleinere verspaningskrachten.
- Betere spananafvoer door spanending.

Order nr.	742161700
Orig. nr.	DRGS170
Aantal stuks	170
Prijs	€ 98,00

TENGOOLS



Metaalborenset geslepen 28 dlg. Diameter 1.0-10mm. Snijshoek 118°. Split punt voor betere positionele nauwkeurigheid. HSS. Standaard boren voor gebruik in staal en gietijzer. DIN 338. Inhoud : 1.0 (4st), 1.5 (3st), 2.0 (2st), 2.5, 3.0, 3.5, 4.0, 4.5, 5.0, 5.5, 6.0, 6.5, 7.0, 7.5, 8.0, 8.5, 9.0, 9.5, 10.0, 3.3, 4.2 en 6.8mm.

Order nr.	151620101
Orig. nr.	DB028
Aantal stuks	28
Prijs	€ 29,90

OPTIMUM



9-delige set gewalste boren met conische schacht. Set MK2 tot en met 22 gewone schacht, 24 en groter met verdunde schacht. MK3 gewone schacht. In alu opbergkoffer met overzichtelijke inleg en maataanduiding.

Order nr.	713051002	713051003
Maten	mm 14,5-16-18-20-22-24-	14,5-16-18-20-22-24-
Aansluiting	MK 2	3
Prijs	€ 139,00	139,00

METALWORK



4-delige set professionele Superior steenboren.

- Professionele steenboor DIN8039 met cilindrische schacht
- Hoogwaardige geslepen uitvoering voor vlugge stofverwijdering.
- Met gebraseerde top (tot 1100°C) voor lange standtijd
- Geschikt voor klopbormachines.
- Hoog rendement zelfs bij intensief gebruik
- Verpakt in een hoogwaardig kunststof opbergcassette.
- Ideaal voor het boren in stenen, beton en marmer.
- Ook beschikbaar in 7-8-12 dlg set op aanvraag.

Order nr.	742069040
Orig. nr.	DRBS4
Maten	mm 5 - 6 - 8 - 10
Prijs	€ 9,80

METALWORK



6-delige speed-houtborenset.

- Korte uitvoering - lengte 150 mm
- Hardheid boorkop HRC 48 - 50
- Hexagonale (zeskant) 1/4 aansluiting
- Voor het boren in zacht en hard hout
- Verpakt in een hoogwaardig kunststof opbergcassette.

Order nr.	742110006
Orig. nr.	DRHSET
Maten	mm 10-12-16-18-20-25
Prijs	€ 15,00

METALWORKS



Industriële centerborensset, HSS, DIN333 vorm A, 60°, Metrisch, volledig geslepen, rechts, 7 delig in een hoogwaardige kunststofdoos met inleg.

Bij het boren van gaten op een metalen oppervlak zoekt de boor telkens naar een uitweg, dus maakt men best eerst een gatje, dit gebeurt met een centerboor, zo zoekt de boor het center van het gat, voorkomt men dat de boor wegloopt en bekomt men een preciezere geleiding van de boor. Kan gebruikt worden op allerlei toestellen, maar meestal op draaibanken.

Diameters: 1.0 x 3.15 - 1.6 x 4.0 - 2.0 x 5.0 - 2.5 x 6.3 - 3.15 x 8.0 - 4.0 x 10.0 - 5.0 x 12.5 mm

Order nr.	748240000
Orig. nr.	DRCDS1
Aantal stuks	7
Prijs	€ 19,90

METALWORKS



6-delige set HSS M2 verzinkboren

- DIN335C
- Hoek 90°
- Met cilindrische schacht.
- Verpakt in een hoogwaardige kunststof doos.

Order nr.	713051026
Orig. nr.	MTMS6
Aantal stuks	6
Maten	mm 6,3 - 8,3 - 10,4 - 12,4 - 16,5 - 20,5
Prijs	€ 35,90

METALWORKS



Tailles	4-12	4-20
Nombre d'étapes	3	3
Flâges	mm 4-5-6-7-8-9-10-11-12	4-6-8-10-12-14-16-18-20
Max. épaisseur du matériau	mm 3	3
Longueur	mm 4	5

Maten	4-12	4-20
Aantal stappen	3	3
Slagpen	mm 4-5-6-7-8-9-10-11-12	4-6-8-10-12-14-16-18-20
Max. materiaalste	mm 3	3
Schacht	mm 4	5

3-delige set trapboren, kwaliteitstaal HSS, Titanium gecoat, rechte uitvoering en cilindrische schacht. Van 4-12, 4-20 en 6-30 mm. Voor het boren van buizen, platen en dunne materialen zoals staal. De TiN coating zorgt ervoor dat het snij oppervlak van de trapboor een hogere graad van hardheid krijgt en hogere stabiliteit van temperatuur aan kan met een lagere wrijvingscoëfficiënt. Verpakt in een hoogwaardige kunststof doos.

Order nr.	713051063
Orig. nr.	MTMS3
Aantal stuks	3
Maten	mm 4-12 - 4-20 - 6-30
Prijs	€ 49,00

METALWORKS



Cutting voordeel pack Metalworks 4 in 1:

1. DRGS25, 742162500, 25-dlg set geslepen boren 1-13 mm
2. MTMS15, 713051015, 15-dlg set tappen M3-M12 + bijhorende boren
3. MTMS6, 713051026, 6-dlg set verzinkboren 6,3 tem 20,5 mm
4. MTMS3, 713051063, 3-dlg set trapboren TiN 4-12, 4-20, 6-30

Bespaar op uw afzonderlijke sets!

Order nr.	713051004
Orig. nr.	MTM4
Prijs	€ 159,00

Kernboren

METALWORKS



RED LINE

1. HSS-E kernboren vervaardigd uit super taai hoge kwaliteitstaal
2. Multicut geometrisch geslepen wat een lagere wrijvingscoëfficiënt genereert, garandeert zo een langere levensduur en betere spananafvoer.
3. Weldong 19.05 mm, voor een vastere klemming, wat resulteert in een stabielere snede en een preciezere afwerking van de gaten.

HQ kernboren van Metalworks zijn beschikbaar in snijdieptes van 25 en 50 mm. Iedere kernboor wordt individueel verpakt in een hoogwaardige kunststoffen koker.

Order nr.	Orig. nr.	Diameter mm	Snijdiepte mm	Prijs €
790302512	HQL2512	12	25	9,90
790302513	HQL2513	13	25	9,90
790302514	HQL2514	14	25	10,90
790302515	HQL2515	15	25	11,50
790302516	HQL2516	16	25	12,50
790302517	HQL2517	17	25	12,50
790302518	HQL2518	18	25	13,50
790302519	HQL2519	19	25	13,50
790302520	HQL2520	20	25	15,50
790302521	HQL2521	21	25	15,50
790302522	HQL2522	22	25	17,50
790302523	HQL2523	23	25	17,50
790302524	HQL2524	24	25	18,50
790302525	HQL2525	25	25	18,50
790302526	HQL2526	26	25	19,90
790302527	HQL2527	27	25	20,50
790302528	HQL2528	28	25	20,50
790302529	HQL2529	29	25	21,50
790302530	HQL2530	29	25	21,90
790302531	HQL2531	31	25	23,50
790302532	HQL2532	32	25	24,00
790302533	HQL2533	33	25	24,90
790302534	HQL2534	34	25	25,90
790302535	HQL2535	35	25	26,50
790302536	HQL2536	36	25	27,90
790302537	HQL2537	37	25	28,90
790302538	HQL2538	38	25	29,50
790302539	HQL2539	39	25	30,50
790302540	HQL2540	40	25	31,50
790302541	HQL2541	41	25	37,50
790302542	HQL2542	42	25	40,50
790302543	HQL2543	43	25	42,50
790302544	HQL2544	44	25	45,50
790302545	HQL2545	45	25	46,50
790302546	HQL2546	46	25	48,50
790302547	HQL2547	47	25	49,90
790302548	HQL2548	48	25	51,50
790302549	HQL2549	49	25	52,50
790302550	HQL2550	50	25	55,90
790302551	HQL2551	51	25	57,50
790302552	HQL2552	52	25	59,00
790302553	HQL2553	53	25	60,50
790302554	HQL2554	54	25	62,50
790302555	HQL2555	55	25	63,50
790302556	HQL2556	56	25	66,50

Order nr.	Orig. nr.	Diameter mm	Snijdiepte mm	Prijs €
790302557	HQL2557	57	25	67,50
790302558	HQL2558	58	25	69,50
790302559	HQL2559	59	25	71,00
790302560	HQL2560	60	25	72,90
790302561	HQL2561	61	25	77,50
790302562	HQL2562	62	25	79,50
790302563	HQL2563	63	25	80,90
790302564	HQL2564	64	25	82,50
790302565	HQL2565	65	25	84,50
790305012	HQL5012	12	50	12,90
790305013	HQL5013	13	50	12,90
790305014	HQL5014	14	50	13,50
790305015	HQL5015	15	50	14,50
790305016	HQL5016	16	50	15,50
790305017	HQL5017	17	50	15,50
790305018	HQL5018	18	50	16,50
790305019	HQL5019	19	50	16,50
790305020	HQL5020	20	50	18,50
790305021	HQL5021	21	50	18,50
790305022	HQL5022	22	50	20,50
790305023	HQL5023	23	50	20,50
790305024	HQL5024	24	50	22,90
790305025	HQL5025	25	50	22,90
790305026	HQL5026	26	50	23,90
790305027	HQL5027	27	50	24,50
790305028	HQL5028	28	50	25,50
790305029	HQL5029	29	50	26,90
790305030	HQL5030	30	50	27,90
790305031	HQL5031	31	50	28,50
790305032	HQL5032	32	50	29,50
790305033	HQL5033	33	50	30,90
790305034	HQL5034	34	50	32,50
790305035	HQL5035	35	50	33,90
790305036	HQL5036	36	50	35,50
790305037	HQL5037	37	50	37,50
790305038	HQL5038	38	50	38,90
790305039	HQL5039	39	50	40,50
790305040	HQL5040	40	50	48,50
790305041	HQL5041	41	50	50,50
790305042	HQL5042	42	50	51,50
790305043	HQL5043	43	50	53,50
790305044	HQL5044	44	50	54,50
790305045	HQL5045	45	50	56,50
790305046	HQL5046	46	50	59,50
790305047	HQL5047	47	50	64,50
790305048	HQL5048	48	50	67,00
790305049	HQL5049	49	50	68,90
790305050	HQL5050	50	50	72,50
790305051	HQL5051	51	50	74,50
790305052	HQL5052	52	50	76,50
790305053	HQL5053	53	50	78,00
790305054	HQL5054	54	50	80,00
790305055	HQL5055	55	50	81,90
790305056	HQL5056	56	50	85,50
790305057	HQL5057	57	50	88,00
790305058	HQL5058	58	50	89,90
790305059	HQL5059	59	50	82,50
790305060	HQL5060	60	50	94,50
790305061	HQL5061	61	50	100,00
790305062	HQL5062	62	50	103,00
790305063	HQL5063	63	50	105,00
790305064	HQL5064	64	50	107,00
790305065	HQL5065	65	50	109,00



Kernboren. Kwaliteit: 100% geslepen M2 staal. Made in Germany. Lengte 25 of 50 mm met Weldon-opname 3/4" (19 mm). Optimale snijresultaten: HSS-XE voor staal tot 750N (beter dan HSS).

METALWORKS



Pilootpin kernboren voor maten 12 tot 65mm.
 Afmetingen CPK25:
 6,34/5,3x77mm
 Afmetingen CPL50:
 6,34/5,3x102mm

Order nr.	790302600 ^M	790302601 ^M
Orig. nr.	CPK25	CPL50
Snijdiepte mm	25	50
Prijs €	4,90	5,50

METALWORKS



Adapter voor kernboren
 Metalworks werkt met kernboren
 Weldon 19.05 mm. Ook geschikt
 voor boormachines.

Order nr.	790302631 ^M	790302633 ^M	790302635 ^M
Orig. nr.	KBH50MK2	KBH50MK3	KBH50MK4
Morse konus	MK 2	3	4
Snijdiepte mm	25/50	25/50	25/50
Prijs €	43,90	46,90	52,90

METALWORKS



Set kernboren HSS-E 6-dlg + pin. Maten 12-14-16-18-20-22mm. Snijdiepte 25mm.

Order nr.	790302500 ^M
Orig. nr.	HQS625
Gewicht kg	1,20
Afmetingen (l x b x h) mm	200 x 110 x 35
Prijs €	99,00

Order nr.	Orig. nr.	Boorlengte mm	Diameter mm	Prijs €
748252512 ^M	38720125512	25	12	16,50
748252513 ^M	38720125513	25	13	16,50
748252514 ^M	38720125514	25	14	17,00
748252515 ^M	38720125515	25	15	17,00
748252516 ^M	38720125516	25	16	18,50
748252517 ^M	38720125517	25	17	18,50
748252518 ^M	38720125518	25	18	19,00
748252519 ^M	38720125519	25	19	18,90
748252520 ^M	38720125520	25	20	20,50
748252521 ^M	38720125521	25	21	20,50
748252522 ^M	38720125522	25	22	25,00
748252523 ^M	38720125523	25	23	25,50
748252524 ^M	38720125524	25	24	26,50
748252525 ^M	38720125525	25	25	26,50
748252526 ^M	38720125526	25	26	28,50
748252527 ^M	38720125527	25	27	28,50
748252528 ^M	38720125528	25	28	30,50
748252529 ^M	38720125529	25	29	32,50
748252530 ^M	38720125530	25	30	34,50
748252531 ^M	38720125531	25	31	33,90
748252532 ^M	38720125532	25	32	35,50
748252533 ^M	38720125533	25	33	33,50
748252534 ^M	38720125534	25	34	34,50
748252535 ^M	38720125535	25	35	34,50
748252536 ^M	38720125536	25	36	38,50
748252537 ^M	38720125537	25	37	39,50
748252538 ^M	38720125538	25	38	42,50
748252539 ^M	38720125539	25	39	42,50
748252540 ^M	38720125540	25	40	46,50
748252541 ^M	38720125541	25	41	46,50
748252542 ^M	38720125542	25	42	49,90
748252543 ^M	38720125543	25	43	49,90
748252544 ^M	38720125544	25	44	54,90
748252545 ^M	38720125545	25	45	54,90
748252546 ^M	38720125546	25	46	58,90
748252547 ^M	38720125547	25	47	59,50
748252548 ^M	38720125548	25	48	62,50
748252549 ^M	38720125549	25	49	62,50
748252550 ^M	38720125550	25	50	66,50
748252551 ^M	38720125551	25	51	66,50
748252552 ^M	38720125552	25	52	70,90
748252553 ^M	38720125553	25	53	73,00
748252554 ^M	38720125554	25	54	75,50
748252555 ^M	38720125555	25	55	77,50
748252556 ^M	38720125556	25	56	79,90
748252557 ^M	38720125557	25	57	82,50
748252558 ^M	38720125558	25	58	84,50
748252559 ^M	38720125559	25	59	87,50
748252560 ^M	38720125560	25	60	90,00
748255012 ^M	38720126512	50	12	21,50
748255013 ^M	38720126513	50	13	21,50
748255014 ^M	38720126514	50	14	22,50
748255015 ^M	38720126515	50	15	22,50
748255016 ^M	38720126516	50	16	23,00
748255017 ^M	38720126517	50	17	23,50
748255018 ^M	38720126518	50	18	24,90
748255019 ^M	38720126519	50	19	24,90

Order nr.	Orig. nr.	Boorlengte mm	Diameter mm	Prijs €
748255020	38720126520	50	20	26,90
748255021	38720126521	50	21	26,90
748255022	38720126522	50	22	30,50
748255023	38720126523	50	23	30,50
748255024	38720126524	50	24	32,00
748255025	38720126525	50	25	32,00
748255026	38720126526	50	26	34,50
748255027	38720126527	50	27	33,50
748255028	38720126528	50	28	36,50
748255029	38720126529	50	29	36,50
748255030	38720126530	50	30	38,00
748255031	38720126531	50	31	38,00
748255032	38720126532	50	32	40,50
748255033	38720126533	50	33	40,50
748255034	38720126534	50	34	43,50
748255035	38720126535	50	35	43,50
748255036	38720126536	50	36	49,00
748255037	38720126537	50	37	50,50
748255038	38720126538	50	38	53,50
748255039	38720126539	50	39	53,50
748255040	38720126540	50	40	58,50
748255041	38720126541	50	41	58,50
748255042	38720126542	50	42	63,50
748255043	38720126543	50	43	63,50
748255044	38720126544	50	44	69,50
748255045	38720126545	50	45	69,50
748255046	38720126546	50	46	74,50
748255047	38720126547	50	47	74,50
748255048	38720126548	50	48	79,00
748255049	38720126549	50	49	79,00
748255050	38720126550	50	50	89,00
748255051	38720126551	50	51	89,00
748255052	38720126552	50	52	91,50
748255053	38720126553	50	53	94,50
748255054	38720126554	50	54	97,50
748255055	38720126555	50	55	101,00
748255056	38720126556	50	56	104,00
748255057	38720126557	50	57	107,00
748255058	38720126558	50	58	110,00
748255059	38720126559	50	59	112,00
748255060	38720126560	50	60	115,00



Centreerpin. Voor gebruik met kernboren 25 of 50 mm.

Order nr.	748252501	748255001
Orig. nr.	387201261	387201271
Omschrijving	kort - 25mm	lang - 50mm
Prijs	€ 6,70	7,20



HSS-XE verzinkbaar 3 lippen. Met universele Weldon schacht 19mm 3/4" 90°. Voor gebruik op kernboormachines of op machines met Weldon-opname.

Order nr.	Orig. nr.	Diameter mm	Lengte mm	Prijs €
748255080	20129525	25	43	23,50
748255081	20129530	30	47	29,50
748255082	20129540	40	52	40,50
748255083	20129555	55	63	74,90



Kernborens set met 6 kernboren en 1 centreerpin. Boren uit HSS-XE staal met geharde tanden voor hoge slijtvastheid. Boor ø 18 is uitgevoerd in de BLUE LINE hoogste kwaliteit van oppervlaktehardheid en - gladheid. Weldon opname 19 mm.

Order nr.	713873008
Orig. nr.	3873008
Kernboren	mm 12-14-16-18-20-22
Lengte	mm 25
Prijs	€ 154,00



Set van 6 kernboren en 4 centreerpinnen. Vervaardigd uit hooggelegeerd HSS-XE staal en met geharde tanden (tot 68 HRC), voor een hoge slijtvastheid en lage levensduur. Met 19 mm Weldon-opname. Optimale snijresultaten: HSS-XE voor staal tot 750N (beter dan HSS). Made in Germany.

Order nr.	748250025	748250050
Orig. nr.	387201474	387201475
Kernboren	mm 14-16-18-20-22-26	14-16-18-20-22-26
Lengte boren	mm 25	50
Prijs	€ 169,00	199,00



Set van 25 kernboren en 4 centreerpinnen. Vervaardigd uit hooggelegeerd HSS-XE staal en met geharde tanden (tot 68 HRC), voor een hoge slijtvastheid en lage levensduur. Met 19 mm Weldon-opname. Optimale snijresultaten: HSS-XE voor staal tot 750N (beter dan HSS). Made in Germany.

Order nr.	748250033
Orig. nr.	387201484
Kernboren	mm 12-13-14-15-16-17-18-19-20-21-22-23-24-25-26-27-28-29-30-31-32-33-34-35-36
Lengte boren	mm 50
Prijs	€ 1.049,00

Vloeiboren

THERMADRILL



Starterkit met koffer. De koffer wordt geleverd met gereedschapshouder met koelribben, 2 montagesleutels, 2 borstels, 100g snijpasta en snijolie, en gebruikshandleiding.

Wat is Thermdrill?

Via het Thermdrill vloeiborensysteem boort en tapt u tot 3x sneller dan met klassieke boormethodes.

In slechts 2 stappen tapt u draad:

1. Door verhitting van het metaal wordt eerst het gat gevormd.
2. Na het tappen verkrijgt u een uiterst sterke draadverbinding. Tijdens het vloeiboren smelt het metaal uit tot 3x de oorspronkelijke materiaaldikte. Zo is er voldoende oppervlakte voor een betrouwbare draadverbinding met 4 à 5 omwentelingen.

Besparing van tijd en geld.

THERMADRILL werkt tot 3x sneller dan klassieke blindklinkmoeren, en kost slechts een fractie aan materiaalkosten. Ook het loskomen door vibratie of spanningen komen bij THERMADRILL niet voor.

Op welke machines past THERMADRILL?

- Toepasbaar op normale kolomboormachines en centers
- M3 tot M20 alsook gas en buisdraad mogelijk
- In ronde, vierkante open profielen
- In staal, Inox, koper, aluminium en speciale legeringen

Selecteer uw individuele THERMADRILL set in 3 stappen:

STAP 1. Starterkit ER25 of ER32 Thermdrill.

De koffer wordt geleverd met gereedschapshouder met koelribben, 2 montagesleutels, 2 borstels, 100g snijpasta en snijolie, en gebruikshandleiding.

STAP 2. Toolset Thermdrill.

Bestaande uit een vloeiboor en bijpassende tap.

Hoe kies ik FORM of CUT ?

FORM: vormt een opstaande rand rondom het boorgat.

CUT: geen opstaande rand. Het boorgat komt op gelijke hoogte met de bovenkant van het werkstuk.

STAP 3. Spantang

Voor het vastnemen van de vloeiboor.

Order nr.	718011226 ^M	718011227 ^M
Orig. nr.	GA2	GA3
Maat	MC2/ER25	MK3/ER32
Prijs	€ 360,00	378,00

OPTIMUM



Basisset OPTIMUM Vloeiboren.

Inhoud:

- Haaksleutel
- Steeksleutel
- 4 spantangen Ø 6/ Ø 8/ Ø 10/ Ø 12 mm ER32
- Reductiehuls MK3 / MK2
- Koffer
- Koelmiddel
- Gereedschapshouder MK2/ ER32

Order nr.	713060005 ^M
Orig. nr.	3060005
Prijs	€ 185,00

THERMADRILL



Gereedschapshouder voor TH vloeiboren met alu koelring 75mm, met MK2 of MK3 opname.

Order nr.	718011134 ^M	718011135 ^M
Orig. nr.	THMC2ER25	THMC3ER32
Omschrijving	MK2/ER32	MK3/ER32
Prijs	€ 318,00	336,00

THERMADRILL



Haaksleutel voor het openen van de Thermdrill gereedschapshouder.

Order nr.	718011151 ^M
Orig. nr.	HSMK232
Prijs	€ 18,50

THERMADRILL



Steeksleutel 30mm voor gebruik in combinatie met de Thermdrill haaksleutel.

Order nr.	718011152 ^M
Orig. nr.	MS36
Prijs	€ 10,50

OPTIMUM



Tapgaten zonder speling?

Het kan met vloeiboren.

Geen speling en niet meer meedraaien van moeren. Met een van volgende sets, hebt u een vloeiboer en een draadtap, type CUT, volgens de gewenste metrische draad. CUT is het vloeiboren zonder een kraag. Een kraag kan nodig zijn als u werkt met dunwandige buizen en er te weinig materiaal voor handen is om voldoende draad te genereren, dan opteert u voor het type FORM, zie ordernr. 713060024 tot en met 713060032. Vergeet uw basis set KBSMK23, 713060005, niet te bestellen, als ook de pasta niet 713060090 en de tapolie 713060092.

Order nr.	Orig. nr.	Maat	Maximum aanbevo- len materiaalsterkte		Prijs €
			M	mm	
713060044 M	SCUTSM4	4	2.0	121,00	
713060045 M	SCUTSM5	5	3.0	149,00	
713060046 M	SCUTSM6	6	3.0	169,00	
713060048 M	SCUTSM8	8	4.0	189,00	
713060050 M	SCUTSM10	10	4.0	214,00	
713060052 M	SCUTSM12	12	4.5	243,00	

OPTIMUM



Tapgaten zonder speling? Te weinig materiaal om uw moer vast te kunnen maken op een buis?

Het kan met vloeiboren.

Geen speling en niet meer meedraaien van moeren. Met een van volgende sets, hebt u een vloeiboer en een draadtap, type FORM, volgens de gewenste metrische draad. FORM is het vloeiboren en het generen van een kraag. Een kraag kan nodig zijn als u werkt met dunwandige buizen en er te weinig materiaal voor handen is om voldoende draad te genereren. Vergeet uw basis set KBSMK23, 713060005, niet te bestellen, als ook de pasta niet 713060090 en de tapolie 713060092.

Order nr.	Orig. nr.	Maat	Maximum aanbevo- len materiaalsterkte		Prijs €
			M	mm	
713060024 M	SFORMSM4	4	1.5	104,00	
713060025 M	SFORMSM5	5	2.0	109,00	
713060026 M	SFORMSM6	6	2.0	119,00	
713060028 M	SFORMSM8	8	2.5	139,00	
713060030 M	SFORMSM10	10	2.5	165,00	
713060032 M	SFORMSM12	12	3.0	193,00	

Thermadrill



Pasta voor TH vloeiboren.

Order nr.	718011178 M	718011179 M
Orig. nr.	TLP100	TLP1000
Omschrijving	kg 0,100	1
Prijs	€ 14,90	49,00

Thermadrill



Thermdrill pasta 5 liter.

Order nr.	718011181 M
Orig. nr.	TLF5000
Prijs	€ 152,00

OPTIMUM



Pasta voor vloeiboren (1000g).

Order nr.	713060090 M
Orig. nr.	3060090
Omschrijving	kg 1
Prijs	€ 63,00

Thermadrill



Tapolie 100 ml.

Order nr.	718011182 M
Orig. nr.	TLO100
Prijs	€ 21,50

Kotterkoppen

METALWORKS



Precisiekotterkop type C. Nauwkeurig op 0.01 mm. Universeel inzetbaar bij boringen, uitdraaien voor het herstellen van pasboringen, binnendraad, etc. Horizontaal en verticaal bruikbaar. Uit hoogwaardig kwaliteitsstaal, gehard en precisiegeslepen. Voorzien van binnendraad. Na het kiezen van de gewenste kotterkop, kiest u een gepaste kegeldoorn en set beitels.

Order nr.	Diameter mm	Gereedschap	Capaciteit mm	Prijs €
790003948 M	50	12	10-125	54,50
790003950 M	75	18	12-225	72,00
790003952 M	100	25	15-320	133,00

METALWORKS



Kegeldoorn voor precisiekotterkop type C voor de meest voorkomende machines. Kegeldoorn kan van tijd tot tijd veranderd worden.

Order nr.	Aansluiting	Voor machine	Prijs €
790007222 M	MK2	B20/B23 Pro/etc	31,90
790007223 M	MK2 / M10	BF16 / BF20 / BF20L	31,90
790003944 M	MK3	B25-3/B26 Pro/etc	32,90
790007224 M	MK3 / M12	MH28V/BF30/F40E	31,90
790003945 M	MK4	B40GSP/B50GSM	32,90
790003947 M	MK4/M16	MB4/MB4P	34,00
790003942 M	ISO30	BF30	38,50
790003943 M	ISO40	BF46 / MF2 / MF4 / UF100	41,50

METALWORKS



Set beitels met Tungsten hardmetalen plaatjes voor kotterkoppen.

Order nr.	Aantal	Schacht mm	Prijs €
713440912 M	9	12	40,50
790007225 M	12	18	51,00
790007226 M	6	25	72,00

OPTIMUM



Precisiekotterkop.

- Voor het maken van pasboringen, ed.
- Horizontaal en verticaal bruikbaar.
- Uit hoogwaardig kwaliteitsstaal, gehard en precisiegeslepen.
- Bereik van diam. 10 tot 220 mm.

Standaard geleverd met uitdraaibeitel, inbusseutel, verlengstuk, klemstuk.

Order nr.	Aansluiting ISO	Aansluiting	Prijs €
713352083 M		MK/CM3	310,00
713352084 M		MK/CM4	309,00
713352085 M	30		309,00
713352086 M	40		309,00

OPTIMUM



Precisiekotterkop in koffer. Automatisch met fijn- en snelafstelling, automatische en dwarsvoeding. Bestaat uit kegeldoorn met kotterkop, 7 kotterbaren, klemhulzen en sleutels. Nauwkeurig op 0,01 mm en een kotterbereik van ø 5 tot ø250 mm. Universeel inzetbaar bij boringen, uitdraaien voor het herstellen van pasboringen, binnendraad, uitwendig draaien, vlakken, etc. Horizontaal en verticaal bruikbaar. Uit hoogwaardig kwaliteitsstaal, gehard en precisiegeslepen. Op aanvraag kunnen ook deze sets ook met andere opnameschachten verkregen worden.

Order nr.	713352074 M
Aansluiting	ISO ISO40 DIN2080
Prijs	€ 1.299,00

Cirkelzaagbladen



Cirkelzaagbladen. Geschikt voor elk type afkortzaag. Snijden is mogelijk zonder koelmiddel. Zaagbladen kunnen geslepen worden.

Order nr.	Voor type	Vertanding	Voor	Afmetingen (l x b x h)	Prijs
		T		mm	€
713850231	M HKS230	48	staal	230 x 2 x 25.4	69,00
713850232	M HKS230	80	alu	230 x 2.4 x 25.4	61,50
713850233	M HKS230	60	inox	230 x 1.8 x 25.4	86,50
713853502	M MTS355-MTS356	80	alu	355 x 2.4 x 25.4	155,00
713853503	M MTS355-MTS356	90	inox	355 x 2.4 x 25.4	169,00
713853504	M MTS355-MTS356	66	staal	355 x 2.4 x 25.4	139,00



Cirkelzaagbladen voor metaal afkortzaagmachines. In HSS en DM05 kwaliteit. Voor alu zaagmachines met Widia vertanding.

Order nr.	Voor type	Kwaliteit	Vertanding	Afmetingen (l x b x h)	Prijs
				mm	€
713652250	M MKS225	HSS DM05	8T	225 x 1.9 x 32	84,00
713652253	M MKS225	HSS DM05	4T	225 x 1.9 x 32	83,50
713652504	M MKS250N-MK-S255N	HSS DM05	T4	250 x 2 x 32	85,50
713652506	M MKS250N-MK-S255N	HSS DM05	T6	250 x 2 x 32	85,00
713357444	M CS275	HSS	T4	275 x 2.5 x 40	97,00
713357446	M CS275	HSS	T6	275 x 2.5 x 40	97,00
713357448	M CS275	HSS	T8	275 x 2.5 x 40	97,00
713653154	M MKS315N-MKS-3155N	HSS DM05	T4	315 x 2.5 x 32	139,00
713653156	M MKS315N-MKS-3155N	HSS DM05	T6	315 x 2.5 x 32	139,00
713653158	M MKS315N-MKS-3155N	HSS DM05	T8	315 x 2.5 x 32	125,00
713357454	M CS315	HSS	T4	315 x 2.5 x 40	132,00
713357456	M CS315	HSS	T6	315 x 2.5 x 40	137,00
713357458	M CS315	HSS	T8	315 x 2.5 x 40	137,00
713653504	M MKS350	HSS DM05	T4	350 x 2.5 x 32	180,00
713653506	M MKS350	HSS DM05	T6	350 x 2.5 x 32	159,00
713650400	M LMS400 - LMS400H - LMS400P LMS400	Widia vertanding	60T	400 x 4 x 32	206,00
713654048	M LMS400H - LMS400P LMS400	Widia vertanding	96T	404 x 4 x 32	219,00
713654049	M LMS400H - LMS400P LMS400	Widia vertanding	84T	400 x 3 x 32	229,00



Prismabek voor MTS355/MTS356.

Order nr.	713850011
Prijs	€ 24,90

Klokgzagen/gatzagen



13-delige set klokgzagen van 19-64 mm in een plasticen koffer inclusief as en koppelstukken.

Order nr.	748261964
Orig. nr.	HSSET1964
Klokgzagen diameter	mm 19 · 22 · 29 · 35 · 38 · 44 · 51 · 57 · 64
Prijs	€ 94,90

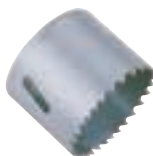

HSS-bimetaal klokgzagen. Voor toepassing in metalen, non-ferro metalen, pvc en hout. Verpakt per stuk.

Order nr.	Orig. nr.	Maat mm	Prijs €
748260016	HSBI16	16	8,30
748260017	HSBI17	17	9,00
748260019	HSBI19	19	9,00
748260020	HSBI20	20	9,00
748260021	HSBI21	21	9,00
748260022	HSBI22	22	9,40
748260024	HSBI24	24	9,00
748260025	HSBI25	25	9,50
748260027	HSBI27	27	10,00
748260029	HSBI29	29	10,00
748260030	HSBI30	30	11,50
748260032	HSBI32	32	10,00
748260033	HSBI33	33	10,00
748260035	HSBI35	35	11,00
748260037	HSBI37	37	11,00
748260038	HSBI38	38	11,00
748260040	HSBI40	40	11,50
748260041	HSBI41	41	11,50
748260043	HSBI43	43	11,50
748260044	HSBI44	44	14,90
748260046	HSBI46	46	12,50
748260048	HSBI48	48	12,50
748260051	HSBI51	51	13,50
748260052	HSBI52	52	15,50
748260054	HSBI54	54	15,50
748260057	HSBI57	57	15,50
748260059	HSBI59	59	15,50
748260060	HSBI60	60	15,50



Order nr.	Orig. nr.	Maat mm	Prijs €
748260064	HSBI64	64	16,50
748260065	HSBI65	65	16,50
748260067	HSBI67	67	16,50
748260068	HSBI68	68	21,50
748260070	HSBI70	70	21,50
748260073	HSBI73	73	16,50
748260076	HSBI76	76	20,50
748260079	HSBI79	79	17,90
748260083	HSBI83	83	18,50
748260086	HSBI86	86	25,90
748260089	HSBI89	89	18,50
748260092	HSBI92	92	21,00
748260095	HSBI95	95	22,50
748260098	HSBI98	98	23,50
748260102	HSBI102	102	25,50
748260105	HSBI105	105	32,50
748260108	HSBI108	108	35,50
748260111	HSBI111	111	36,50
748260114	HSBI114	114	40,00
748260121	HSBI121	121	45,50
748260127	HSBI127	127	48,50
748260140	HSBI140	140	57,90
748260152	HSBI152	152	67,50



As voor klokzagen. Inclusief centerboor.

Order nr.	748261430
Orig. nr.	HSAR1430
Aansluiting	mm HEX 8,5
Voor klokzagen diameter	mm 14-30
Prijs	€ 10,90



As voor klokzagen. Inclusief centerboor.

Order nr.	748263152
Orig. nr.	HSAR32152
Aansluiting	mm HEX 9,5
Voor klokzagen diameter	mm 32-152
Prijs	€ 18,90



As voor klokzagen. Inclusief centerboor.

Order nr.	748264152
Orig. nr.	748264152
Aansluiting	SDS-plus
Prijs	€ 27,50



Centerboor voor 748263152 en 748261430.

Order nr.	748269200
Orig. nr.	HSSD63510
VE	5
Prijs/VE	€ 23,90



Centerboor voor 748264152.

Order nr.	748269201
Orig. nr.	HSSD63580
VE	5
Prijs/VE	€ 23,50



Lintzaagbladen



Lintzaagbladen voor machines van Masko en Metalworks. Industriële kwaliteit voor gebruik op diverse metaal soorten. Deze Bi-metaal zaagbladen bieden een verhoogde productiviteit.

M42 Bi-metaal: sterk productiezaagblad uit M42HSS. Hoge duurzaamheid en sneller verzagen mogelijk van volle materialen en dikwandige profielen.
Toepassingen: staallegingen, gietstaal, carbon staal.

- Speciaal ontworpen om structuurstaal te verzagen.
- Ideaal voor het zagen van bundels en onderbroken zaagsneden met langer levensduur.
- Vermindert trillingen en geluid geassocieerd met onderbroken zaagsneden in profielen.
- Constante tandhoogte voor gelijke spanenbelasting en minder tandstrip.
- Versterkte rugsterkte voor rechttere onderbroken en bundelzaagsneden.

Order nr.	Kwaliteit	Veranding	Voor type	Afmetingen (l x b x h) mm	VE	Min. bestelhoeveelheid	Prijs/VE €
790008093 M	M42	3-4 Tpi HSS Bimet. 0°	BZH220x280	3000 x 27 x 0.9	1	1	41,00
790008094 M	M42	4-6 Tpi HSS Bimet. 0°	BZH220x280	3000 x 27 x 0.9	1	1	41,00
713612308 M	M42	5-8 Tpi HSS Bimet. 0°	BZH220x280	3000 x 27 x 0.9	1	1	40,90
713612310 M	M42	6-10 Tpi HSS Bimet. 0°	BZH220x280	3000 x 27 x 0.9	1	1	40,90
713612314 M	M42	10-14 Tpi HSS Bimet. 0°	BZH220x280	3000 x 27 x 0.9	1	1	41,00
790008154 M	M42	3-4 Tpi HSS Bimet. 0°	BZH300x430	3850 x 27 x 0.9	1	1	44,90
790008153 M	M42	4-6 Tpi HSS Bimet. 0°	BZH300x430	3850 x 27 x 0.9	1	1	44,90
790008152 M	M42	5-8 Tpi HSS Bimet. 0°	BZH300x430	3850 x 27 x 0.9	1	1	44,90
790008151 M	M42	6-10 Tpi HSS Bimet. 0°	BZH300x430	3850 x 27 x 0.9	1	1	44,90
790008188 M	M42	2-3 Tpi HSS Bimet. 0°	BZH350x500	4350 x 34 x 1.1	1	1	60,50
790008189 M	M42	3-4 Tpi HSS Bimet. 0°	BZH350x500	4350 x 34 x 1.1	1	1	60,50
790008190 M	M42	4-6 Tpi HSS Bimet. 0°	BZH350x500	4350 x 34 x 1.1	1	1	60,50
713357553 M	Challenger	2-3Tpi	BZH450x620 Vario	5200 x 34 x 1.1	1	1	169,00
713357552 M	Challenger	3-4Tpi	BZH450x620 Vario	5200 x 34 x 1.1	1	1	169,00
713357551 M	Challenger	4-6Tpi	BZH450x620 Vario	5200 x 34 x 1.1	1	1	169,00
713357550 M	Challenger	5-7 Tpi	BZH450x620 Vario	5200 x 34 x 1.1	1	1	169,00

OPTIMUM



Lintzaagbladen voor machines van: Optimum, Quantum en Metallkraft. Industriële kwaliteit voor gebruik op diverse metaalsoorten. Deze Bi-metaal zaagbladen bieden een verhoogde productiviteit.

M42 Bi-metaal: sterk productiezaagblad uit M42HSS. Hoge duurzaamheid en sneller verzagen mogelijk van volle materialen en dikwandige profielen.
Toepassingen: staallegingen, gietstaal, carbon staal.

Order nr.	Kwaliteit	Vertanding	Voor type	Merk	Afmetingen (l x b x h) mm	VE	Min. bestel- hoeveelheid	Prijs/VE €
713351509	M	Bi-metaal	10-14 Tpi	S92G	Quantum 1300 x 12,7 x 0,5	1	1	21,50
713351106	M	HSS	6 Tpi	S100G	Optimum 1470 x 13 x 0,65	1	1	6,60
713351114	M	HSS	14 Tpi	S100G	Optimum 1470 x 13 x 0,65	1	1	22,50
713351109	M	Bi-metaal	6/10 Tpi	S100G	Optimum 1470 x 13 x 0,65	1	1	22,50
713351110	M	Bi-metaal	10-14 Tpi	S100G	Optimum 1470 x 13 x 0,65	1	1	22,50
713351513	M	HSS	6 Tpi	S121G-S130GH-S131GH	Optimum 1638 x 13 x 0,65	1	1	9,60
713351514	M	HSS	14 Tpi	S122G-S121G-S130GH-S131GH	Optimum 1638 x 13 x 0,65	1	1	9,10
713351511	M	Bi-metaal	6 Tpi	S121G-S130GH-S131GH	Quantum 1638 x 13 x 0,65	1	1	24,00
713351512	M	Bi-metaal	6-10 Tpi	S121G-S130GH-S131GH	Optimum 1638 x 13 x 0,65	1	1	23,90
713351518	M	Bi-metaal	10-14 Tpi	S122G-S121G-S130GH-S131GH	Optimum 1638 x 13 x 0,65	1	1	23,90
713351522	M	M42 Bi-metaal	6-10 Tpi 0°	S150G	Optimum 1735 x 13 x 0,9	1	1	27,50
713357538	M	M42 Bi-metaal	10-14 Tpi 0°	S150G	Optimum 1735 x 13 x 0,9	1	1	27,50
713357519	M	Bi-metaal	10 Tpi	S181-S181G/GG	Optimum 2362 x 19 x 0,9	1	1	23,50
713357518	M	Bi-metaal	14 Tpi	S181-S181G/GG	Optimum 2362 x 19 x 0,9	1	1	23,50
713357522	M	M42 Bi-metaal	5-8 Tpi	S181-S181G/GG	Optimum 2362 x 19 x 0,9	1	1	35,00
713357521	M	M42 Bi-metaal	6-10 Tpi	S181-S181G/GG	Optimum 2362 x 19 x 0,9	1	1	34,90
713357520	M	M42 Bi-metaal	10-14 Tpi	S181-S181G/GG	Optimum 2362 x 19 x 0,9	1	1	34,90
713357526	M	M42 Bi-metaal	4-6 Tpi 0°	S275G-S285DG	Optimum 2480 x 27 x 0,9	1	1	37,50
713357511	M	M42 Bi-metaal	5-8 Tpi	S275G-S285DG	Optimum 2480 x 27 x 0,9	1	1	37,50
713357524	M	M42 Bi-metaal	6-10 Tpi	S275G-S285DG	Optimum 2480 x 27 x 0,9	1	1	37,50
713357525	M	M42 Bi-metaal	10-14 Tpi	S275G-S285DG	Optimum 2480 x 27 x 0,9	1	1	37,50
713357528	M	M42 Bi-metaal	6-10 Tpi	S275G (2005)	Optimum 2460 x 27 x 0,9	1	1	37,50
713357529	M	M42 Bi-metaal	10-14 Tpi	S275G (2005)	Optimum 2450 x 27 x 0,9	1	1	37,50
790008057	M	M42	3-4 Tpi HSS Bimet. 0°	S290-S300DG-310DG	Optimum 2750 x 27 x 0,9	1	1	39,00
790007288	M	M42	4-6 Tpi HSS Bimet. 0°	S290-S300DG-310DG	Optimum 2750 x 27 x 0,9	1	1	39,00
713357754	M	M42		S290-S300DG-310DG	Optimum 2750 x 27 x 0,9	1	1	39,00
713357751	M	M42	5-8 Tpi HSS Bimet. 0°	S290-S300DG-310DG	Optimum 2750 x 27 x 0,9	1	1	39,00
713357752	M	M42		S290-S300DG-310DG	Optimum 2750 x 27 x 0,9	1	1	39,00
790008053	M	M42	10-14 Tpi HSS Bimet. 0°	S290-S300DG-310DG	Optimum 2750 x 27 x 0,9	1	1	39,00
713357753	M	M42	6-10 Tpi HSS Bimet. 0°	S290-S300DG-310DG	Optimum 2750 x 27 x 0,9	1	1	38,90
713357752	M	M42 Bi-metaal	5-8 Tpi 7°	S290-S300DG-S310DG	Optimum 2750 x 27 x 0,9	1	1	39,00
713357530	M	M42 Bi-metaal	4-6 Tpi	S300VG	Optimum 3352 x 27 x 0,9	1	1	45,50
713357531	M	M42 Bi-metaal	5-8 Tpi	S300VG	Optimum 3352 x 27 x 0,9	1	1	45,50
713357532	M	M42 Bi-metaal	6-10 Tpi	S300VG	Optimum 3352 x 27 x 0,9	1	1	45,50
790008080	M	M42	3-4 Tpi HSS Bimet. 0°	S350DG	Optimum 2925 x 27 x 0,9	1	5	42,50
713357540	M	M42	4-6 Tpi HHS Bimet. 0°	S350DG	Optimum 2925 x 27 x 0,9	1	1	42,50
713357541	M	M42	5-8 Tpi HHS Bimet. 0°	S350DG	Optimum 2925 x 27 x 0,9	1	1	42,50
713357542	M	M42	6-10 Tpi HSS Bimet. 0°	S350DG	Optimum 2925 x 27 x 0,9	1	1	42,50
713357543	M	M42	6-10 Tpi HSS Bimet. 0°	S350DG	Optimum 2925 x 27 x 0,9	1	1	42,50
713650011	M	Bi-metaal	6-10 Tpi	MBS85	Metallkraft 1335 x 13 x 0,65	1	1	21,50
713650012	M	Bi-metaal	10-14 Tpi	MBS85	Metallkraft 1335 x 13 x 0,65	1	1	21,50
713650013	M	Bi-metaal	6 Tpi	MBS125	Metallkraft 1440 x 13 x 0,65	1	1	22,50
713650014	M	Bi-metaal	6-10 Tpi	MBS125	Metallkraft 1440 x 13 x 0,65	1	1	22,50
713650015	M	Bi-metaal	10-14 Tpi	MBS125	Metallkraft 1440 x 13 x 0,65	1	1	22,50
713650016	M	Bi-metaal	5-8 Tpi	MBS150-155R	Metallkraft 1735 x 13 x 0,65	1	1	25,50
713650017	M	Bi-metaal	6-10 Tpi	MBS150-155R	Metallkraft 1735 x 13 x 0,65	1	1	25,50
713650018	M	Bi-metaal	10-14 Tpi	MBS150-155R	Metallkraft 1735 x 13 x 0,65	1	1	25,50
713655115	M	M42 Bi-metaal	2-3 Tpi	BMBS240x280	Metallkraft 2980 x 27 x 0,9	1	5	42,90
713655100	M	M42 Bi-metaal	2-3 Tpi	BMBS290-S300DG-S310DGx320-BMBS290-S300DG-S310DGx290	Metallkraft 3100 x 27 x 0,9	1	5	44,00
713655101	M	M42 Bi-metaal	2-3 Tpi	BMBS350x400-HMBS350x400	Metallkraft 4520 x 34 x 1,1	1	5	62,50
713655005	M	M42 Bi-metaal	3-4 Tpi	HMBS440x600	Metallkraft 5720 x 34 x 1,1	1	5	111,00
713655105	M	M42 Bi-metaal	2-3 Tpi	HMBS440x600	Metallkraft 5720 x 34 x 1,1	1	5	111,00
713655205	M	M42 Bi-metaal	5-8 Tpi	HMBS440x600	Metallkraft 5720 x 34 x 1,1	1	5	111,00

Zaagbladen en klokzagen

METAL WORKS



Industriële lintzaagbladen voor algemeen gebruik in verschillende metaalsoorten. Gebruik van deze Bi-metaal kwaliteitszaagbladen verhoogt uw productiviteit en verlaagt de kosten van het zaagproces.

M42 Bi-metaal: sterk productiezaagblad uit M42HSS. Hoge duurzaamheid en sneller verzagen mogelijk van volle materialen en dikwandige profielen.

Toepassingen: staallegingen, gietstaal, carbon staal.

Order nr.	Kwaliteit	Vertanding	Voor type	Afmetingen (l x b x h) mm	VE	Min. bestel- hoeveelheid	Prijs/VE €
790008000	M42	10-14 Tpi HSS Bimet. 0°	MACC (SPECIAL 215) - PEGAS (150x200 MAN)	2060 x 20 x 0.9	1	5	31,90
790008001	M42	6-10 Tpi HSS Bimet. 0°	MACC (SPECIAL 215) - PEGAS (150x200 MAN)	2060 x 20 x 0.9	1	5	31,90
790008002	M42	5-8 Tpi HSS Bimet. 0°	MACC (SPECIAL 215) - PEGAS (150x200 MAN)	2060 x 20 x 0.9	1	5	31,90
713357515	M42	10-14 Tpi HSS Bimet. 0°	UZAY MAKINA (UMS 150 G, UMSY 150 G)	2080 x 20 x 0.9	1	1	31,90
713357514	M42	6-10 Tpi HSS Bimet. 0°	UZAY MAKINA (UMS 150 G, UMSY 150 G)	2080 x 20 x 0.9	1	1	31,90
790008005	M42	5-8 Tpi HSS Bimet. 0°	UZAY MAKINA (UMS 150 G, UMSY 150 G)	2080 x 20 x 0.9	1	1	31,90
790008007	M42	10-14 Tpi HSS Bimet. 0°	IMET (GBS 185 e GH)	2095 x 20 x 0.9	1	5	31,90
790008008	M42	6-10 Tpi HSS Bimet. 0°	IMET (GBS 185 e GH)	2095 x 20 x 0.9	1	5	31,90
790008009	M42	5-8 Tpi HSS Bimet. 0°	IMET (GBS 185 e GH)	2095 x 20 x 0.9	1	5	31,90
790008010	M42	10-14 Tpi HSS Bimet. 0°	SIERRASABI (BR160/220)	2400 x 20 x 0.9	1	5	35,00
790008011	M42	6-10 Tpi HSS Bimet. 0°	SIERRASABI (BR160/220)	2400 x 20 x 0.9	1	5	35,00
790008012	M42	5-8 Tpi HSS Bimet. 0°	SIERRASABI (BR160/220)	2400 x 20 x 0.9	1	5	35,00
790008013	M42	4-6 Tpi HSS Bimet. 0°	SIERRASABI (BR160/220)	2400 x 20 x 0.9	1	5	35,00
790008014	M42	10-14 Tpi HSS Bimet. 0°	MACC (SPECIAL 280, 280CSO, 285M, 285CSO, 285MS) - FMB (200A, 250D, 250DP, 200DS, 250SA, 250SA Piping) - MEBA (220 G) - CARIF (260MB, 260BSA, 260BA CNC) - PEGAS (220x250 MAN, GH)	2450 x 27 x 0.9	1	5	37,50
790008015	M42	6-10 Tpi HSS Bimet. 0°	MACC (SPECIAL 280, 280CSO, 285M, 285CSO, 285MS) - FMB (200A, 250D, 250DP, 200DS, 250SA, 250SA Piping) - MEBA (220 G) - CARIF (260MB, 260BSA, 260BA CNC) - PEGAS (220x250 MAN, GH)	2450 x 27 x 0.9	1	5	37,50
790008016	M42	5-8 Tpi HSS Bimet. 0°	MACC (SPECIAL 280, 280CSO, 285M, 285CSO, 285MS) - FMB (200A, 250D, 250DP, 200DS, 250SA, 250SA Piping) - MEBA (220 G) - CARIF (260MB, 260BSA, 260BA CNC) - PEGAS (220x250 MAN, GH)	2450 x 27 x 0.9	1	5	37,50
790008017	M42	4-6 Tpi HSS Bimet. 0°	MACC (SPECIAL 280, 280CSO, 285M, 285CSO, 285MS) - FMB (200A, 250D, 250DP, 200DS, 250SA, 250SA Piping) - MEBA (220 G) - CARIF (260MB, 260BSA, 260BA CNC) - PEGAS (220x250 MAN, GH)	2450 x 27 x 0.9	1	5	37,50
790008018	M42	3-4 Tpi HSS Bimet. 0°	MACC (SPECIAL 280, 280CSO, 285M, 285CSO, 285MS) - FMB (200A, 250D, 250DP, 200DS, 250SA, 250SA Piping) - MEBA (220 G) - CARIF (260MB, 260BSA, 260BA CNC) - PEGAS (220x250 MAN, GH)	2450 x 27 x 0.9	1	5	37,50
790008024	M42	10-14 Tpi HSS Bimet. 0°	MEBA (200) - PILOUS (ARG200, ARG200PLUS)	2490 x 20 x 0.9	1	5	36,50
790008025	M42	6-10 Tpi HSS Bimet. 0°	MEBA (200) - PILOUS (ARG200, ARG200PLUS)	2490 x 20 x 0.9	1	5	36,50
790008026	M42	5-8 Tpi HSS Bimet. 0°	MEBA (200) - PILOUS (ARG200, ARG200PLUS)	2490 x 20 x 0.9	1	5	36,50
790008027	M42	4-6 Tpi HSS Bimet. 0°	MEBA (200) - PILOUS (ARG200, ARG200PLUS)	2490 x 20 x 0.9	1	5	36,50
790008028	M42	3-4 Tpi HSS Bimet. 0°	MEBA (200) - PILOUS (ARG200, ARG200PLUS)	2490 x 20 x 0.9	1	5	36,50
790008030	M42	10-14 Tpi HSS Bimet. 0°	RAIMONDI (22SAR)	2590 x 27 x 0.9	1	5	37,50
790008031	M42	6-10 Tpi HSS Bimet. 0°	RAIMONDI (22SAR)	2590 x 27 x 0.9	1	5	37,50
790008032	M42	5-8 Tpi HSS Bimet. 0°	RAIMONDI (22SAR)	2590 x 27 x 0.9	1	5	37,50
790008033	M42	4-6 Tpi HSS Bimet. 0°	RAIMONDI (22SAR)	2590 x 27 x 0.9	1	5	37,50
790008034	M42	3-4 Tpi HSS Bimet. 0°	RAIMONDI (22SAR)	2590 x 27 x 0.9	1	5	37,50
790008035	M42	10-14 Tpi HSS Bimet. 0°	PILOUS (ARG220PLUS)	2600 x 27 x 0.9	1	5	39,00
790008036	M42	6-10 Tpi HSS Bimet. 0°	PILOUS (ARG220PLUS)	2600 x 27 x 0.9	1	5	39,00
790008037	M42	5-8 Tpi HSS Bimet. 0°	PILOUS (ARG220PLUS)	2600 x 27 x 0.9	1	5	39,00

Order nr.	Kwaliteit	Vertanding	Voor type	Afmetingen (l x b x h) mm	VE	Min. bestel- hoeveelheid	Prijs/VE €
790008038	M42	4-6 Tpi HSS Bimet. 0°	PILOUS (ARG220PLUS)	2600 x 27 x 0.9	1	5	39,00
790008039	M42	3-4 Tpi HSS Bimet. 0°	PILOUS (ARG220PLUS)	2600 x 27 x 0.9	1	5	39,00
790008040	M42	10-14 Tpi HSS Bimet. 0°	IMET (BASIC 230/60 e GH)	2630 x 20 x 0.9	1	5	37,90
790008041	M42	6-10 Tpi HSS Bimet. 0°	IMET (BASIC 230/60 e GH)	2630 x 20 x 0.9	1	5	37,90
790008042	M42	5-8 Tpi HSS Bimet. 0°	IMET (BASIC 230/60 e GH)	2630 x 20 x 0.9	1	5	37,90
790008043	M42	4-6 Tpi HSS Bimet. 0°	IMET (BASIC 230/60 e GH)	2630 x 20 x 0.9	1	5	37,90
790008044	M42	3-4 Tpi HSS Bimet. 0°	IMET (BASIC 230/60 e GH)	2630 x 20 x 0.9	1	5	37,90
790008045	M42	10-14 Tpi HSS Bimet. 0°	BEHRINGER (SLB 230 G, SLB 230 DG, SLB 230 DG-Halbautomat) - FMB (Triton 280D, Antilia 280DP, Antares 280DS, Orion 310D+S, Uranus 310D+S-P, Sirius 280SA, Omega 310D, S-SA, Centauro, Cynus, Calipaso, Pulsar) - MEBA (230 G/DG/DG-P/GA-P/GA-H/GA-NC) - PILOUS (ARG- 250STANDARD(H), ARG250PLUS(H), ARG, AUTOMAT)	2700 x 27 x 0.9	1	5	39,00
790008046	M42	6-10 Tpi HSS Bimet. 0°	BEHRINGER (SLB 230 G, SLB 230 DG, SLB 230 DG-Halbautomat) - FMB (Triton 280D, Antilia 280DP, Antares 280DS, Orion 310D+S, Uranus 310D+S-P, Sirius 280SA, Omega 310D, S-SA, Centauro, Cynus, Calipaso, Pulsar) - MEBA (230 G/DG/DG-P/GA-P/GA-H/GA-NC) - PILOUS (ARG- 250STANDARD(H), ARG250PLUS(H), ARG, AUTOMAT)	2700 x 27 x 0.9	1	5	39,00
790008047	M42	5-8 Tpi HSS Bimet. 0°	BEHRINGER (SLB 230 G, SLB 230 DG, SLB 230 DG-Halbautomat) - FMB (Triton 280D, Antilia 280DP, Antares 280DS, Orion 310D+S, Uranus 310D+S-P, Sirius 280SA, Omega 310D, S-SA, Centauro, Cynus, Calipaso, Pulsar) - MEBA (230 G/DG/DG-P/GA-P/GA-H/GA-NC) - PILOUS (ARG- 250STANDARD(H), ARG250PLUS(H), ARG, AUTOMAT)	2700 x 27 x 0.9	1	5	39,00
790008048	M42	4-6 Tpi HSS Bimet. 0°	BEHRINGER (SLB 230 G, SLB 230 DG, SLB 230 DG-Halbautomat) - FMB (Triton 280D, Antilia 280DP, Antares 280DS, Orion 310D+S, Uranus 310D+S-P, Sirius 280SA, Omega 310D, S-SA, Centauro, Cynus, Calipaso, Pulsar) - MEBA (230 G/DG/DG-P/GA-P/GA-H/GA-NC) - PILOUS (ARG- 250STANDARD(H), ARG250PLUS(H), ARG, AUTOMAT)	2700 x 27 x 0.9	1	5	39,00
790008049	M42	3-4 Tpi HSS Bimet. 0°	BEHRINGER (SLB 230 G, SLB 230 DG, SLB 230 DG-Halbautomat) - FMB (Triton 280D, Antilia 280DP, Antares 280DS, Orion 310D+S, Uranus 310D+S-P, Sirius 280SA, Omega 310D, S-SA, Centauro, Cynus, Calipaso, Pulsar) - MEBA (230 G/DG/DG-P/GA-P/GA-H/GA-NC) - PILOUS (ARG- 250STANDARD(H), ARG250PLUS(H), ARG, AUTOMAT)	2700 x 27 x 0.9	1	5	39,00
790008053	M42	10-14 Tpi HSS Bimet. 0°	MEP (260, 260 MA)	2750 x 27 x 0.9	1	5	39,00
713357753	M42	6-10 Tpi HSS Bimet. 0°	MEP (260, 260 MA)	2750 x 27 x 0.9	1	1	38,90
713357751	M42	5-8 Tpi HSS Bimet. 0°	MEP (260, 260 MA)	2750 x 27 x 0.9	1	1	38,90
790007288	M42	4-6 Tpi HSS Bimet. 0°	MEP (260, 260 MA)	2750 x 27 x 0.9	1	5	39,00
790008057	M42	3-4 Tpi HSS Bimet. 0°	MEP (260, 260 MA)	2750 x 27 x 0.9	1	5	39,00
790008058	M42	10-14 Tpi HSS Bimet. 0°	IMET (BS 300/60, BS 300/60 SH, BS 300 PLUS GH, BS 300 PLUS SHI, BS 300/60 GH, BS 300 PLUS, BS 300 PLUS SH, BS 300/60 AFIE, BS 300/60 AFH-NC)	2770 x 27 x 0.9	1	5	40,50
790008059	M42	6-10 Tpi HSS Bimet. 0°	IMET (BS 300/60, BS 300/60 SH, BS 300 PLUS GH, BS 300 PLUS SHI, BS 300/60 GH, BS 300 PLUS, BS 300 PLUS SH, BS 300/60 AFIE, BS 300/60 AFH-NC)	2770 x 27 x 0.9	1	5	40,50
790008060	M42	5-8 Tpi HSS Bimet. 0°	IMET (BS 300/60, BS 300/60 SH, BS 300 PLUS GH, BS 300 PLUS SHI, BS 300/60 GH, BS 300 PLUS, BS 300 PLUS SH, BS 300/60 AFIE, BS 300/60 AFH-NC)	2770 x 27 x 0.9	1	5	40,50
790008061	M42	4-6 Tpi HSS Bimet. 0°	IMET (BS 300/60, BS 300/60 SH, BS 300 PLUS GH, BS 300 PLUS SHI, BS 300/60 GH, BS 300 PLUS, BS 300 PLUS SH, BS 300/60 AFIE, BS 300/60 AFH-NC)	2770 x 27 x 0.9	1	5	40,50
790008062	M42	3-4 Tpi HSS Bimet. 0°	IMET (BS 300/60, BS 300/60 SH, BS 300 PLUS GH, BS 300 PLUS SHI, BS 300/60 GH, BS 300 PLUS, BS 300 PLUS SH, BS 300/60 AFIE, BS 300/60 AFH-NC)	2770 x 27 x 0.9	1	5	40,50
790008063	M42	10-14 Tpi HSS Bimet. 0°	MACC (SPECIAL 301M, 301CSO, 301M/S, 315A, 320M, 320M/S, 320CSO) - MEBA (220 DG) - PEGAS (250x315 GH) - MEP (280, 280 MA, 280 SXI)	2825 x 27 x 0.9	1	5	40,50
790008064	M42	6-10 Tpi HSS Bimet. 0°	MACC (SPECIAL 301M, 301CSO, 301M/S, 315A, 320M, 320M/S, 320CSO) - MEBA (220 DG) - PEGAS (250x315 GH) - MEP (280, 280 MA, 280 SXI)	2825 x 27 x 0.9	1	5	40,50
790008065	M42	5-8 Tpi HSS Bimet. 0°	MACC (SPECIAL 301M, 301CSO, 301M/S, 315A, 320M, 320M/S, 320CSO) - MEBA (220 DG) - PEGAS (250x315 GH) - MEP (280, 280 MA, 280 SXI)	2825 x 27 x 0.9	1	5	40,50
790008066	M42	4-6 Tpi HSS Bimet. 0°	MACC (SPECIAL 301M, 301CSO, 301M/S, 315A, 320M, 320M/S, 320CSO) - MEBA (220 DG) - PEGAS (250x315 GH) - MEP (280, 280 MA, 280 SXI)	2825 x 27 x 0.9	1	5	40,50

Zaagbladen en klokzagen

Order nr.	Kwaliteit	Vertanding	Voor type	Afmetingen (l x b x h) mm	VE	Min. bestel- hoeveelheid	Prijs/VE €
790008067	M42	3-4 Tpi HSS Bimet. 0°	MACC (SPECIAL 301M, 301CSO, 301M/S, 315A, 320M, 320M/S, 320CSO) - MEBA (220 DG) - PEGAS (250x315 GH) - MEP (280, 280 MA, 280 SX)	2825 x 27 x 0.9	1	5	40,50
790008071	M42	10-14 Tpi HSS Bimet. 0°	KASTO (Funktional M/U/P/A)	2910 x 27 x 0.9	1	5	42,50
790008072	M42	6-10 Tpi HSS Bimet. 0°	KASTO (Funktional M/U/P/A)	2910 x 27 x 0.9	1	5	42,50
790008073	M42	5-8 Tpi HSS Bimet. 0°	KASTO (Funktional M/U/P/A)	2910 x 27 x 0.9	1	5	42,50
790008074	M42	4-6 Tpi HSS Bimet. 0°	KASTO (Funktional M/U/P/A)	2910 x 27 x 0.9	1	5	42,50
790008075	M42	3-4 Tpi HSS Bimet. 0°	KASTO (Funktional M/U/P/A)	2910 x 27 x 0.9	1	5	42,50
713357543	M42	10-14 Tpi HSS Bimet. 0°	SIERRASABI (BR 240/320, BR 240/320 M, BR 240/320 H)	2925 x 27 x 0.9	1	1	42,50
713357542	M42	6-10 Tpi HSS Bimet. 0°	SIERRASABI (BR 240/320, BR 240/320 M, BR 240/320 H)	2925 x 27 x 0.9	1	1	42,50
713357541	M42	5-8 Tpi HSS Bimet. 0°	SIERRASABI (BR 240/320, BR 240/320 M, BR 240/320 H)	2925 x 27 x 0.9	1	1	42,50
713357540	M42	4-6 Tpi HSS Bimet. 0°	SIERRASABI (BR 240/320, BR 240/320 M, BR 240/320 H)	2925 x 27 x 0.9	1	1	42,50
790008080	M42	3-4 Tpi HSS Bimet. 0°	SIERRASABI (BR 240/320, BR 240/320 M, BR 240/320 H)	2925 x 27 x 0.9	1	5	42,50
790008081	M42	10-14 Tpi HSS Bimet. 0°	MEP (280 SX)	2950 x 27 x 0.9	1	5	42,50
790008082	M42	6-10 Tpi HSS Bimet. 0°	MEP (280 SX)	2950 x 27 x 0.9	1	5	42,50
790008083	M42	5-8 Tpi HSS Bimet. 0°	MEP (280 SX)	2950 x 27 x 0.9	1	5	42,50
790008084	M42	4-6 Tpi HSS Bimet. 0°	MEP (280 SX)	2950 x 27 x 0.9	1	5	42,50
790008085	M42	3-4 Tpi HSS Bimet. 0°	MEP (280 SX)	2950 x 27 x 0.9	1	5	42,50
790008086	M42	10-14 Tpi HSS Bimet. 0°	PEGAS (240x280 GH, 240x280 A-CNC)	2980 x 27 x 0.9	1	5	42,90
790008087	M42	6-10 Tpi HSS Bimet. 0°	PEGAS (240x280 GH, 240x280 A-CNC)	2980 x 27 x 0.9	1	5	42,90
713655206	M42	5-8 Tpi HSS Bimet. 0°	PEGAS (240x280 GH, 240x280 A-CNC)	2980 x 27 x 0.9	1	5	42,90
713655116	M42	4-6 Tpi HSS Bimet. 0°	PEGAS (240x280 GH, 240x280 A-CNC)	2980 x 27 x 0.9	1	5	42,90
713655013	M42	3-4 Tpi HSS Bimet. 0°	PEGAS (240x280 GH, 240x280 A-CNC)	2980 x 27 x 0.9	1	5	42,90
713612314	M42	10-14 Tpi HSS Bimet. 0°	KARMETAL (KMT220KDG) - UZAY MAKINA (UMSY 220 G)	3000 x 27 x 0.9	1	1	41,00
790008093	M42	3-4 Tpi HSS Bimet. 0°	KARMETAL (KMT220KDG) - UZAY MAKINA (UMSY 220 G) - METAL- WORKS	3000 x 27 x 0.9	1	1	41,00
790008094	M42	4-6 Tpi HSS Bimet. 0°	KARMETAL (KMT220KDG) - UZAY MAKINA (UMSY 220 G) - METAL- WORKS	3000 x 27 x 0.9	1	1	41,00
713612308	M42	5-8 Tpi HSS Bimet. 0°	KARMETAL (KMT220KDG) - UZAY MAKINA (UMSY 220 G) - METAL- WORKS	3000 x 27 x 0.9	1	1	40,90
713612310	M42	6-10 Tpi HSS Bimet. 0°	KARMETAL (KMT220KDG) - UZAY MAKINA (UMSY 220 G) - METAL- WORKS	3000 x 27 x 0.9	1	1	40,90
790008098	M42	6-10 Tpi HSS Bimet. 0°	MEBA (180) - CARIF (320BSA, 320BA CNC)	3020 x 27 x 0.9	1	5	42,50
790008099	M42	5-8 Tpi HSS Bimet. 0°	MEBA (180) - CARIF (320BSA, 320BA CNC)	3020 x 27 x 0.9	1	5	42,50
790008100	M42	4-6 Tpi HSS Bimet. 0°	MEBA (180) - CARIF (320BSA, 320BA CNC)	3020 x 27 x 0.9	1	5	42,50
790008101	M42	3-4 Tpi HSS Bimet. 0°	MEBA (180) - CARIF (320BSA, 320BA CNC)	3020 x 27 x 0.9	1	5	42,50
790008103	M42	6-10 Tpi HSS Bimet. 0°	IMET (BASIC 270/60 e GH) - PEGAS (290x320 GH, 290x290 A-CNC) - PILOUS (ARG300STANDARD(H), ARG300PLUS(H), ARG, AUTOMAT)	3100 x 27 x 0.9	1	5	44,00
713655200	M42	5-8 Tpi HSS Bimet. 0°	IMET (BASIC 270/60 e GH) - PEGAS (290x320 GH, 290x290 A-CNC) - PILOUS (ARG300STANDARD(H), ARG300PLUS(H), ARG, AUTOMAT)	3100 x 27 x 0.9	1	5	44,00
790008105	M42	4-6 Tpi HSS Bimet. 0°	IMET (BASIC 270/60 e GH) - PEGAS (290x320 GH, 290x290 A-CNC) - PILOUS (ARG300STANDARD(H), ARG300PLUS(H), ARG, AUTOMAT)	3100 x 27 x 0.9	1	5	44,00
713655000	M42	3-4 Tpi HSS Bimet. 0°	IMET (BASIC 270/60 e GH) - PEGAS (290x320 GH, 290x290 A-CNC) - PILOUS (ARG300STANDARD(H), ARG300PLUS(H), ARG, AUTOMAT)	3100 x 27 x 0.9	1	5	43,90
790008109	M42	6-10 Tpi HSS Bimet. 0°	MEP (320, 320 AX, 320 AXI, 320 CNC, 320 MA, 320 SX, 320 SXI, 330 CNCFE)	3150 x 27 x 0.9	1	5	44,00
790008110	M42	5-8 Tpi HSS Bimet. 0°	MEP (320, 320 AX, 320 AXI, 320 CNC, 320 MA, 320 SX, 320 SXI, 330 CNCFE)	3150 x 27 x 0.9	1	5	44,00
790008111	M42	4-6 Tpi HSS Bimet. 0°	MEP (320, 320 AX, 320 AXI, 320 CNC, 320 MA, 320 SX, 320 SXI, 330 CNCFE)	3150 x 27 x 0.9	1	5	44,00
790008112	M42	3-4 Tpi HSS Bimet. 0°	MEP (320, 320 AX, 320 AXI, 320 CNC, 320 MA, 320 SX, 320 SXI, 330 CNCFE)	3150 x 27 x 0.9	1	5	44,00

Order nr.	Kwaliteit	Vertanding	Voor type	Afmetingen (l x b x h) mm	VE	Min. bestel- hoeveelheid	Prijs/VE €
790008113	M42	6-10 Tpi HSS Bimet. 0°	BEHRINGER (SLB 240 A, SLB 240 A/G, SLB 240 G-Halbbautomat)	3180 x 27 x 0.9	1	5	44,00
790008114	M42	5-8 Tpi HSS Bimet. 0°	BEHRINGER (SLB 240 A, SLB 240 A/G, SLB 240 G-Halbbautomat)	3180 x 27 x 0.9	1	5	44,00
790008115	M42	4-6 Tpi HSS Bimet. 0°	BEHRINGER (SLB 240 A, SLB 240 A/G, SLB 240 G-Halbbautomat)	3180 x 27 x 0.9	1	5	44,00
790008116	M42	3-4 Tpi HSS Bimet. 0°	BEHRINGER (SLB 240 A, SLB 240 A/G, SLB 240 G-Halbbautomat)	3180 x 27 x 0.9	1	5	44,00
790008117	M42	6-10 Tpi HSS Bimet. 0°	FMB (Galactica 400SAV)	3420 x 27 x 0.9	1	5	47,50
790008118	M42	5-8 Tpi HSS Bimet. 0°	FMB (Galactica 400SAV)	3420 x 27 x 0.9	1	5	47,50
790008119	M42	4-6 Tpi HSS Bimet. 0°	FMB (Galactica 400SAV)	3420 x 27 x 0.9	1	5	47,50
790008120	M42	3-4 Tpi HSS Bimet. 0°	FMB (Galactica 400SAV)	3420 x 27 x 0.9	1	5	47,50
790008121	M42	6-10 Tpi HSS Bimet. 0°	AMADA (H-250 SA, HA-250, HDA-250, HFA-250)	3505 x 27 x 0.9	1	5	47,50
790008122	M42	5-8 Tpi HSS Bimet. 0°	AMADA (H-250 SA, HA-250, HDA-250, HFA-250)	3505 x 27 x 0.9	1	5	47,50
790008123	M42	4-6 Tpi HSS Bimet. 0°	AMADA (H-250 SA, HA-250, HDA-250, HFA-250)	3505 x 27 x 0.9	1	5	47,50
790008124	M42	3-4 Tpi HSS Bimet. 0°	AMADA (H-250 SA, HA-250, HDA-250, HFA-250)	3505 x 27 x 0.9	1	5	47,50
790008126	M42	6-10 Tpi HSS Bimet. 0°	UZAY MAKINA (UMSY 280, UMS 280, UMSO 280, UMSO 280H) - AMADA (CRH-300 S, CHA-300 S) - MEBA (251, 251 A, 301 G, 301 GA)	3660 x 27 x 0.9	1	5	43,50
790008127	M42	5-8 Tpi HSS Bimet. 0°	UZAY MAKINA (UMSY 280, UMS 280, UMSO 280, UMSO 280H) - AMADA (CRH-300 S, CHA-300 S) - MEBA (251, 251 A, 301 G, 301 GA)	3660 x 27 x 0.9	1	5	43,50
790008128	M42	4-6 Tpi HSS Bimet. 0°	UZAY MAKINA (UMSY 280, UMS 280, UMSO 280, UMSO 280H) - AMADA (CRH-300 S, CHA-300 S) - MEBA (251, 251 A, 301 G, 301 GA)	3660 x 27 x 0.9	1	5	43,50
790008129	M42	3-4 Tpi HSS Bimet. 0°	UZAY MAKINA (UMSY 280, UMS 280, UMSO 280, UMSO 280H) - AMADA (CRH-300 S, CHA-300 S) - MEBA (251, 251 A, 301 G, 301 GA)	3660 x 27 x 0.9	1	5	43,50
790008132	M42	6-10 Tpi HSS Bimet. 0°	CARIF (450BSA, 450BA CNC)	3660 x 34 x 1.1	1	5	53,50
790008133	M42	5-8 Tpi HSS Bimet. 0°	CARIF (450BSA, 450BA CNC)	3660 x 34 x 1.1	1	5	53,50
790008134	M42	4-6 Tpi HSS Bimet. 0°	CARIF (450BSA, 450BA CNC)	3660 x 34 x 1.1	1	5	53,50
790008135	M42	3-4 Tpi HSS Bimet. 0°	CARIF (450BSA, 450BA CNC)	3660 x 34 x 1.1	1	5	53,50
790008136	M42	6-10 Tpi HSS Bimet. 0°	BEHRINGER (HBP 220, HBP 220 A)	3720 x 27 x 0.9	1	5	43,50
790008137	M42	5-8 Tpi HSS Bimet. 0°	BEHRINGER (HBP 220, HBP 220 A)	3720 x 27 x 0.9	1	5	43,50
790008138	M42	4-6 Tpi HSS Bimet. 0°	BEHRINGER (HBP 220, HBP 220 A)	3720 x 27 x 0.9	1	5	43,50
790008139	M42	3-4 Tpi HSS Bimet. 0°	BEHRINGER (HBP 220, HBP 220 A)	3720 x 27 x 0.9	1	5	43,50
790008140	M42	6-10 Tpi HSS Bimet. 0°	BEHRINGER (HBP 220, HBP 220 A)	3720 x 34 x 1.1	1	5	53,50
790008141	M42	5-8 Tpi HSS Bimet. 0°	BEHRINGER (HBP 220, HBP 220 A)	3720 x 34 x 1.1	1	5	53,50
790008142	M42	4-6 Tpi HSS Bimet. 0°	BEHRINGER (HBP 220, HBP 220 A)	3720 x 34 x 1.1	1	5	53,50
790008143	M42	3-4 Tpi HSS Bimet. 0°	BEHRINGER (HBP 220, HBP 220 A)	3720 x 34 x 1.1	1	5	53,50
790008144	M42	5-8 Tpi HSS Bimet. 0°	MEBA (270, 270 A, 305 G, 305 DG, 305 GA, 250 A, 250, 320) - SIERRASABI (BR 260)	3800 x 27 x 0.9	1	5	44,50
790008145	M42	4-6 Tpi HSS Bimet. 0°	MEBA (270, 270 A, 305 G, 305 DG, 305 GA, 250 A, 250, 320) - SIERRASABI (BR 260)	3800 x 27 x 0.9	1	5	44,50
790008146	M42	3-4 Tpi HSS Bimet. 0°	MEBA (270, 270 A, 305 G, 305 DG, 305 GA, 250 A, 250, 320) - SIERRASABI (BR 260)	3800 x 27 x 0.9	1	5	44,50
790008148	M42	5-8 Tpi HSS Bimet. 0°	MEBA (300 A, 310 GA, 310 G, 320, 320 A, 325)	3800 x 34 x 1.1	1	5	53,50
790008149	M42	4-6 Tpi HSS Bimet. 0°	MEBA (300 A, 310 GA, 310 G, 320, 320 A, 325)	3800 x 34 x 1.1	1	5	53,50
790008150	M42	3-4 Tpi HSS Bimet. 0°	MEBA (300 A, 310 GA, 310 G, 320, 320 A, 325)	3800 x 34 x 1.1	1	5	53,50
790008151	M42	6-10 Tpi HSS Bimet. 0°	KARMETAL (KMT300)	3850 x 27 x 0.9	1	1	44,90
790008152	M42	5-8 Tpi HSS Bimet. 0°	KARMETAL (KMT300)	3850 x 27 x 0.9	1	1	44,90
790008153	M42	4-6 Tpi HSS Bimet. 0°	KARMETAL (KMT300)	3850 x 27 x 0.9	1	1	44,90
790008154	M42	3-4 Tpi HSS Bimet. 0°	KARMETAL (KMT300)	3850 x 27 x 0.9	1	1	44,90
790008155	M42	5-8 Tpi HSS Bimet. 0°	AMADA (HK 400)	3885 x 34 x 1.1	1	5	55,50
790008156	M42	4-6 Tpi HSS Bimet. 0°	AMADA (HK 400)	3885 x 34 x 1.1	1	5	55,50
790008157	M42	3-4 Tpi HSS Bimet. 0°	AMADA (HK 400)	3885 x 34 x 1.1	1	5	55,50

Zaagbladen en klokzagen

Order nr.	Kwaliteit	Vertanding	Voor type	Afmetingen (l x b x h) mm	VE	Min. bestel- hoeveelheid	Prijs/VE €
790008158	M42	5-8 Tpi HSS Bimet. 0°	KARMETAL (KMT 300 WOS) - KASTO (SSB 260 VA to serial no. 106)	3910 x 34 x 1.1	1	5	55,50
790008159	M42	4-6 Tpi HSS Bimet. 0°	KARMETAL (KMT 300 WOS) - KASTO (SSB 260 VA to serial no. 106)	3910 x 34 x 1.1	1	5	55,50
790008160	M42	3-4 Tpi HSS Bimet. 0°	KARMETAL (KMT 300 WOS) - KASTO (SSB 260 VA to serial no. 106)	3910 x 34 x 1.1	1	5	55,50
790008162	M42	5-8 Tpi HSS Bimet. 0°	IMET (BS 400 SHI)	4030 x 34 x 1.1	1	5	56,90
790008163	M42	4-6 Tpi HSS Bimet. 0°	IMET (BS 400 SHI)	4030 x 34 x 1.1	1	5	56,90
790008164	M42	3-4 Tpi HSS Bimet. 0°	IMET (BS 400 SHI)	4030 x 34 x 1.1	1	5	56,90
790008165	M42	5-8 Tpi HSS Bimet. 0°	BEHRINGER (HBP 260 A)	4100 x 34 x 1.1	1	5	56,90
790008166	M42	4-6 Tpi HSS Bimet. 0°	BEHRINGER (HBP 260 A)	4100 x 34 x 1.1	1	5	56,90
790008167	M42	3-4 Tpi HSS Bimet. 0°	BEHRINGER (HBP 260 A)	4100 x 34 x 1.1	1	5	56,90
790008170	M42	5-8 Tpi HSS Bimet. 0°	KASTO (SSB 260 VA to serial-no. 114)	4115 x 41 x 1.3	1	5	72,50
790008171	M42	4-6 Tpi HSS Bimet. 0°	KASTO (SSB 260 VA to serial-no. 114)	4115 x 41 x 1.3	1	5	72,50
790008172	M42	3-4 Tpi HSS Bimet. 0°	KASTO (SSB 260 VA to serial-no. 114)	4115 x 41 x 1.3	1	5	72,50
790008173	M42	5-8 Tpi HSS Bimet. 0°	MEBA (310 DG, ECO 320 G/GA)	4200 x 27 x 0.9	1	5	47,50
790008174	M42	4-6 Tpi HSS Bimet. 0°	MEBA (310 DG, ECO 320 G/GA)	4200 x 27 x 0.9	1	5	47,50
790008175	M42	3-4 Tpi HSS Bimet. 0°	MEBA (310 DG, ECO 320 G/GA)	4200 x 27 x 0.9	1	5	47,50
790008176	M42	5-8 Tpi HSS Bimet. 0°	MEBA (260 A, 280, 280 A, 310 G-L, 310 GA-L, 320 DG, 320 DGA, ECO 320 G/GA variable)	4200 x 34 x 1.1	1	5	58,50
790008177	M42	4-6 Tpi HSS Bimet. 0°	MEBA (260 A, 280, 280 A, 310 G-L, 310 GA-L, 320 DG, 320 DGA, ECO 320 G/GA variable)	4200 x 34 x 1.1	1	5	58,50
790008178	M42	3-4 Tpi HSS Bimet. 0°	MEBA (260 A, 280, 280 A, 310 G-L, 310 GA-L, 320 DG, 320 DGA, ECO 320 G/GA variable)	4200 x 34 x 1.1	1	5	58,50
790008179	M42	5-8 Tpi HSS Bimet. 0°	UZAY MAKINA (UMSY 330, UMSY 330 G, UMSO 330, UMSO 330 DG)	4260 x 34 x 1.1	1	5	58,50
790008180	M42	4-6 Tpi HSS Bimet. 0°	UZAY MAKINA (UMSY 330, UMSY 330 G, UMSO 330, UMSO 330 DG)	4260 x 34 x 1.1	1	5	58,50
790008181	M42	3-4 Tpi HSS Bimet. 0°	UZAY MAKINA (UMSY 330, UMSY 330 G, UMSO 330, UMSO 330 DG)	4260 x 34 x 1.1	1	5	58,50
790008182	M42	5-8 Tpi HSS Bimet. 0°	PILOUS (ARG400PLUS SAF)	4300 x 34 x 1.1	1	5	60,50
790008183	M42	4-6 Tpi HSS Bimet. 0°	PILOUS (ARG400PLUS SAF)	4300 x 34 x 1.1	1	5	60,50
790008184	M42	3-4 Tpi HSS Bimet. 0°	PILOUS (ARG400PLUS SAF)	4300 x 34 x 1.1	1	5	60,50
790008185	M42	5-8 Tpi HSS Bimet. 0°	KASTO (SBA 260/400 U/G, BSM 260/400 B/G)	4310 x 27 x 0.9	1	5	49,00
790008186	M42	4-6 Tpi HSS Bimet. 0°	KASTO (SBA 260/400 U/G, BSM 260/400 B/G)	4310 x 27 x 0.9	1	5	49,00
790008187	M42	3-4 Tpi HSS Bimet. 0°	KASTO (SBA 260/400 U/G, BSM 260/400 B/G)	4310 x 27 x 0.9	1	5	49,00
790008188	M42	2-3 Tpi HSS Bimet. 0°	KARMETAL (KMT350KDG)	4350 x 34 x 1.1	1	1	60,50
790008189	M42	3-4 Tpi HSS Bimet. 0°	KARMETAL (KMT350KDG)	4350 x 34 x 1.1	1	1	60,50
790008190	M42	4-6 Tpi HSS Bimet. 0°	KARMETAL (KMT350KDG)	4350 x 34 x 1.1	1	1	60,50
790008191	M42	5-8 Tpi HSS Bimet. 0°	MEBA (ECO 320 DG/DGA, ECO 335/335 A/G/GA, DG/DGA-1300-3300)	4400 x 34 x 1.1	1	5	60,50
790008192	M42	4-6 Tpi HSS Bimet. 0°	MEBA (ECO 320 DG/DGA, ECO 335/335 A/G/GA, DG/DGA-1300-3300)	4400 x 34 x 1.1	1	5	60,50
790008193	M42	3-4 Tpi HSS Bimet. 0°	MEBA (ECO 320 DG/DGA, ECO 335/335 A/G/GA, DG/DGA-1300-3300)	4400 x 34 x 1.1	1	5	60,50
790008194	M42	5-8 Tpi HSS Bimet. 0°	SIERRASABI (BR 350)	4440 x 34 x 1.1	1	5	60,50
790008195	M42	4-6 Tpi HSS Bimet. 0°	SIERRASABI (BR 350)	4440 x 34 x 1.1	1	5	60,50
790008196	M42	3-4 Tpi HSS Bimet. 0°	SIERRASABI (BR 350)	4440 x 34 x 1.1	1	5	60,50
713655201	M42	5-8 Tpi HSS Bimet. 0°	PEGAS (350x400 SHI, 350x400 A-CNC, 350x400 H)	4520 x 34 x 1.1	1	5	62,50
790008198	M42	4-6 Tpi HSS Bimet. 0°	PEGAS (350x400 SHI, 350x400 A-CNC, 350x400 H)	4520 x 34 x 1.1	1	5	62,50
713655001	M42	3-4 Tpi HSS Bimet. 0°	PEGAS (350x400 SHI, 350x400 A-CNC, 350x400 H)	4520 x 34 x 1.1	1	5	62,50
790008200	M42	5-8 Tpi HSS Bimet. 0°	SIERRASABI (PSR 320)	4570 x 27 x 0.9	1	5	50,50
790008201	M42	4-6 Tpi HSS Bimet. 0°	SIERRASABI (PSR 320)	4570 x 27 x 0.9	1	5	50,50
790008202	M42	3-4 Tpi HSS Bimet. 0°	SIERRASABI (PSR 320)	4570 x 27 x 0.9	1	5	50,50



Order nr.	Kwaliteit	Vertanding	Voor type	Afmetingen (l x b x h) mm	VE	Min. bestel- hoeveelheid	Prijs/VE €
790008203	M42	5-8 Tpi HSS Bimet. 0°	AMADA (HA-400, HFA-400) - UZAY MAKINA (UMSY-350, UMSO 350)	4570 x 34 x 1.1	1	5	62,50
790008204	M42	4-6 Tpi HSS Bimet. 0°	AMADA (HA-400, HFA-400) - UZAY MAKINA (UMSY-350, UMSO 350)	4570 x 34 x 1.1	1	5	62,50
790008205	M42	3-4 Tpi HSS Bimet. 0°	AMADA (HA-400, HFA-400) - UZAY MAKINA (UMSY-350, UMSO 350)	4570 x 34 x 1.1	1	5	62,50
790008207	M42	5-8 Tpi HSS Bimet. 0°	AMADA (HFA-400 W)	4570 x 41 x 1.3	1	5	79,50
790008208	M42	4-6 Tpi HSS Bimet. 0°	AMADA (HFA-400 W)	4570 x 41 x 1.3	1	5	79,50
790008209	M42	3-4 Tpi HSS Bimet. 0°	AMADA (HFA-400 W)	4570 x 41 x 1.3	1	5	79,50
790008210	M42	5-8 Tpi HSS Bimet. 0°	MACC (SPECIAL 420DI)	4610 x 34 x 1.1	1	5	64,50
790008211	M42	4-6 Tpi HSS Bimet. 0°	MACC (SPECIAL 420DI)	4610 x 34 x 1.1	1	5	64,50
790008212	M42	3-4 Tpi HSS Bimet. 0°	MACC (SPECIAL 420DI)	4610 x 34 x 1.1	1	5	64,50
790008214	M42	5-8 Tpi HSS Bimet. 0°	BEHRINGER (HBP 303, HBP 303 A)	4640 x 41 x 1.3	1	5	81,50
790008215	M42	4-6 Tpi HSS Bimet. 0°	BEHRINGER (HBP 303, HBP 303 A)	4640 x 41 x 1.3	1	5	81,50
790008216	M42	3-4 Tpi HSS Bimet. 0°	BEHRINGER (HBP 303, HBP 303 A)	4640 x 41 x 1.3	1	5	81,50
790008217	M42	5-8 Tpi HSS Bimet. 0°	BEHRINGER (340, 340 A)	4670 x 34 x 1.1	1	5	84,50
790008218	M42	4-6 Tpi HSS Bimet. 0°	BEHRINGER (340, 340 A)	4670 x 34 x 1.1	1	5	64,50
790008219	M42	3-4 Tpi HSS Bimet. 0°	BEHRINGER (340, 340 A)	4670 x 34 x 1.1	1	5	64,50
790008220	M42	5-8 Tpi HSS Bimet. 0°	PEGAS (360x500 GH)	4780 x 34 x 1.1	1	5	66,00
790008221	M42	4-6 Tpi HSS Bimet. 0°	PEGAS (360x500 GH)	4780 x 34 x 1.1	1	5	66,00
790008222	M42	3-4 Tpi HSS Bimet. 0°	PEGAS (360x500 GH)	4780 x 34 x 1.1	1	5	66,00
790008223	M42	5-8 Tpi HSS Bimet. 0°	BEHRINGER (HBP 320, HBP 320 A, HBP 340, HBP 340 A, HBP 340 G)	4860 x 34 x 1.1	1	5	66,00
790008224	M42	4-6 Tpi HSS Bimet. 0°	BEHRINGER (HBP 320, HBP 320 A, HBP 340, HBP 340 A, HBP 340 G)	4860 x 34 x 1.1	1	5	66,00
790008225	M42	3-4 Tpi HSS Bimet. 0°	BEHRINGER (HBP 320, HBP 320 A, HBP 340, HBP 340 A, HBP 340 G)	4860 x 34 x 1.1	1	5	66,00
790008226	M42	5-8 Tpi HSS Bimet. 0°	KASTO (CUT GE 3, CUT GU 3, POS GA 2, POS GA 3, POS A 2, POS A 3)	4930 x 34 x 1.1	1	5	67,90
790008227	M42	4-6 Tpi HSS Bimet. 0°	KASTO (CUT GE 3, CUT GU 3, POS GA 2, POS GA 3, POS A 2, POS A 3)	4930 x 34 x 1.1	1	5	67,90
790008228	M42	3-4 Tpi HSS Bimet. 0°	KASTO (CUT GE 3, CUT GU 3, POS GA 2, POS GA 3, POS A 2, POS A 3)	4930 x 34 x 1.1	1	5	67,90
790008229	M42	5-8 Tpi HSS Bimet. 0°	FMB (Pluton 1 1200SAV)	4980 x 27 x 0.9	1	5	54,50
790008230	M42	4-6 Tpi HSS Bimet. 0°	FMB (Pluton 1 1200SAV)	4980 x 27 x 0.9	1	5	54,50
790008231	M42	3-4 Tpi HSS Bimet. 0°	FMB (Pluton 1 1200SAV)	4980 x 27 x 0.9	1	5	54,50
790008232	M42	5-8 Tpi HSS Bimet. 0°	BEHRINGER (HBP 313 G, HBP 310/523 G, HBP 310/403 GA, HBP 313 A)	5000 x 34 x 1.1	1	5	67,90
790008233	M42	4-6 Tpi HSS Bimet. 0°	BEHRINGER (HBP 313 G, HBP 310/523 G, HBP 310/403 GA, HBP 313 A)	5000 x 34 x 1.1	1	5	67,90
790008234	M42	3-4 Tpi HSS Bimet. 0°	BEHRINGER (HBP 313 G, HBP 310/523 G, HBP 310/403 GA, HBP 313 A)	5000 x 34 x 1.1	1	5	67,90
790008235	M42	5-8 Tpi HSS Bimet. 0°	FMB (Pluton 2)	5020 x 34 x 1.1	1	5	67,90
790008236	M42	4-6 Tpi HSS Bimet. 0°	FMB (Pluton 2)	5020 x 34 x 1.1	1	5	67,90
790008237	M42	3-4 Tpi HSS Bimet. 0°	FMB (Pluton 2)	5020 x 34 x 1.1	1	5	67,90

Kies het juiste zaagblad

Keuze van de vertanding

Het gebruik van de juiste vertanding leidt tot efficiënt zagen, tegen de laagste kostprijs per snede.

De vertanding is het aantal tanden per duim (25,4mm) (TPI). De algemene regel is: Minimum 3 tanden moeten in het materiaal ingrijpen, om tot een aanvaardbaar resultaat te komen.

De juiste vertanding wordt bepaald door de dikte en vorm van het werkstuk. Gebruik van de selectietabel hieronder:

1. bepaal het type profiel: vol materiaal of buismateriaal
2. bepaal de dikte van het materiaal
3. lees de juiste vertanding af

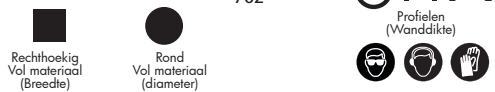
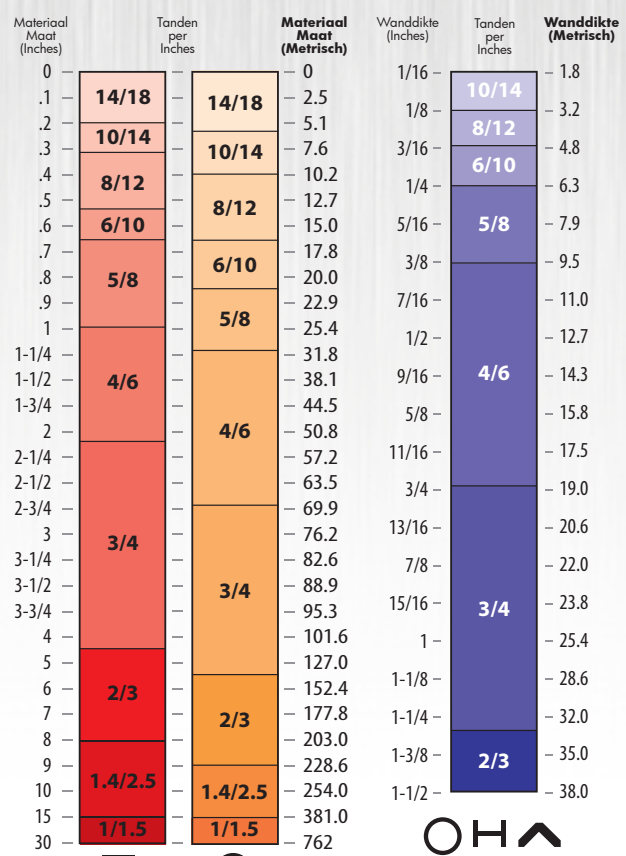

Keuze van het type blad

In de tabel vindt u een overzicht van de meest gebruikte materialen en het type zaagblad dat hiervoor geschikt is.

	CARBON STEELS	STRUCTURAL STEELS	ALUMINUM & LT. ALLOY STEELS	ALLOY STEELS MOLD STEELS	TOOL STEELS	STAINLESS STEELS
AISI	1010, 1020, 1045	A36	6061, 2011, 2024, 5052	4140, P20	A2, H13, S7 M-SERIES	316, 304 17-4 PH, 15-5 PH
JIS	S20C, S45C		6061, 2011, 2024, 5052	SCM 440(H), SCM 445(H)	SHD11, SHD12, SKD61, SKS41	SUS316, SUS304
DIN	Ck45, C16.8		AlCuPb, AlCuMg2, AlMg2Mn0.3	41CrMo4	X155CrVMoV51, (G)X40CrMoV51	X5CrNiMo18 10, X5CrNi18 10

MATRIX II

M42

THE ACHIEVER™

Opspannen van het werkstuk

Het te bewerken werkstuk moet vast worden opgespannen, zo dat het niet kan vibreren of draaien. Gebruik geen beschadigde, gebogen of sterk vervormde werkstukken. Hoe dichter de zaagbladgeleidingen zich tegen het stuk bevinden, hoe exacter de zaagsnede.

Vul de machineklem niet helemaal, maar blijf een stuk onder de opgegeven capaciteit van de zaagmachine. Dit zal de efficiëntie verhogen, en levensduur van de zaagbladen verlengen. Bij het verzagen van bundels, is het soms vereist om met bovenklemming te werken, zoals hieronder weergegeven:

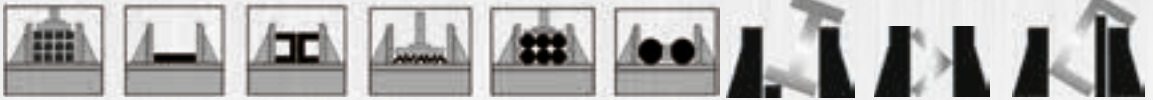

Zaagsnelheid & Daalsnelheid **Problemen met spaandervorming**

Het soort materiaal en het type zaagblad bepalen de juiste zaagsnelheid (m/min) en de daalsnelheid. Bepaal in de selectietabel de optimale zaagsnelheid. De tabel is vereenvoudigd, raadpleeg onze binnendienst voor exacte zaagsnelheid bij complexere toepassingen.

Materiaal	Snelheid in m/min (M42)
Bouwstaal/automatenstaal	80-90
Inzetstaal	45-75
Niet-gelegeerd werktuigstaal	40-60
Gelegeerd werktuig	30-40
Niet-roestend staal	20-35
Hittebestanding staal	15-25

De efficiëntie van het zaagproces kan worden verhoogd, door de spaandervorming in de gaten te houden en de machine bij te stellen indien nodig.

Koelvloeistof

Het gebruik van koelvloeistof wordt aanbevolen, daar deze de levensduur van het zaagblad verlengt door het te koelen en te smeren. De juiste ratio koelvloeistof/water dient bovendien opgevolgd te worden voor optimaal resultaat.

Controleer geregeld de spaanders die gevormd worden met onderstaande tabel, en stel de machine bij indien nodig:

Chip Form				
Chip Condition	Thick, Hard, and Short	Thin and Curled	Powder	Thin and Curl Tight
Chip Color	Blue or Brown	Silver	Silver	Silver
Blade Speed	Decrease ↓	Suitable ✓	Decrease ↓	Suitable ✓
Blade Feed	Decrease ↓	Suitable ✓	Increase ↑	Decrease ↓
Other	Check Cutting Fluid & Mix			Check Tooth Pitch

Inlopen van zaagbladen

Het correct inlopen van een zaagblad garandeert een lange levensduur. Scherpe snijkanten met een kleine kantradius zijn noodzakelijk.

Belangrijk bij nieuwe zaagbladen!

Vergelijk een nieuw zaagblad met een vers geslepen potlood: ze hebben extreem scherpe tanden die moeten worden ingebroken voor een optimaal gebruik.

Dit kan door de daalsnelheid met 50% te verminderen tijdens de eerste 50 tot 100 sneden, en daarna langzaam op te drijven tot de normale waarde.

Nieuwe zaagbladen kunnen in het begin vibraties en trillingsgeluiden voortbrengen. Indien dit gebeurt, moeten zaagsnelheid en/of daalsnelheid worden verminderd.

MORSE
THE M. K. MORSE COMPANY



Schuurbanden

OPTIMUM



Kwaliteitsschuurbanden op linnendrager.

Voor algemeen gebruik voor metaal en hout. Aluminium oxide korrel. Geschikt voor volgende modellen Optimum DBS75, BSM75, BSM150, Metallkraft MBSM101-130 en BTS50/51, Metalworks BS75200. Ook geschikt voor andere schuurmachines met gelijke breedte en lengte. Minimum bestelhoeveelheid 10 stuks.

Order nr.	Afmetingen (l x b) mm	Korrel K	Voor type	VE	Min. bestelhoeveelheid	Prijs/VE €
713721004 M	50 x 1000	40	Metallkraft BTS50/51	1	10	3,90
713721006 M	50 x 1000	60	Metallkraft BTS50/51	1	10	3,70
713721008 M	50 x 1000	80	Metallkraft BTS50/51	1	10	3,70
713721010 M	50 x 1000	100	Metallkraft BTS50/51	1	10	4,50
713357622 M	75 x 1180	40	Optimum DBS75	1	10	6,80
713357624 M	75 x 1180	60	Optimum DBS75	1	10	6,60
713357626 M	75 x 1180	80	Optimum DBS75	1	10	6,50
713357628 M	75 x 1180	120	Optimum DBS75	1	10	6,40
713357642 M	75 x 2000	40	Optimum BSM75 - Metalworks BS75200	1	10	7,00
713357644 M	75 x 2000	60	Optimum BSM75 - Metalworks BS75200	1	10	6,80
713357646 M	75 x 2000	80	Optimum BSM75 - Metalworks BS75200	1	10	6,40
713357648 M	75 x 2000	120	Optimum BSM75 - Metalworks BS75200	1	10	6,20
713726040 M	100 x 1220	40	Metallkraft MBSM101-130	1	10	5,50
713726060 M	100 x 1220	60	Metallkraft MBSM101-130	1	10	5,30
713726080 M	100 x 1220	80	Metallkraft MBSM101-130	1	10	5,20
713726120 M	100 x 1220	120	Metallkraft MBSM101-130	1	10	5,10
713357672 M	150 x 2000	40	Optimum BSM150	1	10	11,50
713357674 M	150 x 2000	60	Optimum BSM150	1	10	11,50
713357676 M	150 x 2000	80	Optimum BSM150	1	10	11,00
713357678 M	150 x 2000	120	Optimum BSM150	1	10	10,90

Metallkraft



Kwaliteitsschuurbanden op linnendrager voor slijpmachines Metallkraft RPSM1 en RPSM2.

713722612, 713722640 en 713722660 - bruine kleur
 744591204, 744591206 en 744591212 - blauwe kleur
 713722712, 713722740 en 713722760 - groene kleur

Order nr.	Type	Afmetingen (l x b) mm	Korrel K	VE	Min. bestelhoeveelheid	Prijs/VE €
713722612 M	staal	100 x 2000	120	1	10	8,00
713722640 M	staal	100 x 2000	40	1	10	9,10
713722660 M	staal	100 x 2000	60	1	10	8,10
744591204 M	staal zirconium	100 x 2000	40	1	10	13,00
744591206 M	staal zirconium	100 x 2000	60	1	10	11,50
744591212 M	staal zirconium	100 x 2000	120	1	10	9,20
713722712 M	inox	100 x 2000	120	1	10	12,50
713722740 M	inox	100 x 2000	40	1	10	16,50
713722760 M	inox	100 x 2000	60	1	10	13,90

OPTIMUM



Schuurbanden voor slijpmachine SM200SL.

Order nr.	Afmetingen (l x b) mm	Korrel K	VE	Min. bestelhoeveelheid	Prijs/VE €
713357612 M	75 x 762	40	1	10	5,40
713357614 M	75 x 762	60	1	10	5,30
713357616 M	75 x 762	80	1	10	5,40
713357618 M	75 x 762	120	1	10	5,30

OPTIMUM



Schuurbanden voor slijpmachine SM250SL

Order nr.	Afmetingen (l x b) mm	Korrel K	VE	Min. bestelhoeveelheid	Prijs/VE €
713357682 M	75 x 1016	40	1	10	7,00
713357684 M	75 x 1016	60	1	10	7,00
713357686 M	75 x 1016	80	1	10	7,00
713357688 M	75 x 1016	120	1	10	7,00

OPTIMUM



Grafietschijven voor bandschuurmachines Optimum BSM, Metallkraft MBSM en BTS50/51

Order nr.	Breedte mm	Voor type	Gewicht kg	Prijs/VE €
713722128 M	75	BSM75/MBSM75	1,00	26,53
713722080 M	150	BSM150/MBSM150	1,00	30,59

Schuurschijven

Werkbanklijpstenen voor slijpmolens Optimum model SM en andere slijpmolens indien rekening gehouden wordt met het asgat en breedte van de slijpsteen. Beschikbaar in twee korrelsoorten. Grove korrelsoort 36 voor het brutere werk en een fijnere korrelsoort 80 voor het fijnere werk. Slijpstenen zijn geschikt voor het slijpen van HSS.

OPTIMUM



Order nr.	Slijpsteenafmetingen (diameter x b x asgat) mm	Korrel K	Prijs €
713107150 M	150x20x16	36	11,50
713107155 M	150x20x16	80	11,50
713107170 M	175x20x32	36	15,50
713107175 M	175x20x32	80	15,50
713107180 M	175x25x32	36	16,50
713107185 M	175x25x32	80	16,50
713107200 M	200x25x32	36	19,50
713107205 M	200x25x32	80	19,50
713107210 M	200x30x32	36	19,90
713107215 M	200x30x32	80	19,90
713107250 M	250x30x32	36	30,50
713107255 M	250x30x32	80	30,50
713107270 M	300x50x75	36	57,00
713107275 M	300x50x75	80	57,00



OPTIMUM



Polierschijven voor Optimum poliermachines PSM

Order nr.	Orig. nr.	Omschrijving	Diameter mm	Voor type	Asgat mm	Prijs €
713107320 M	3107320	zacht	200x20	PSM 200	16	22,50
713107321 M	3107321	hard	200x20	PSM 200	16	22,50
713107330 M	3107330	zacht	250x25	PSM 250	20	28,50
713107331 M	3107331	hard	250x25	PSM 250	20	28,50

IN LINE



Rondborstels voor slijpmachines QSM en SM. Geleverd met flensringen 12.7mm, 15.887mm, 19.05mm, 22.225mm en 25.4mm.

Order nr.	Orig. nr.	Diameter mm	Asgat mm	Voor type	Prijs €
724581180 T	HA5440623008	150	32	QSM 150	6,30
724581190 T	HA5660623008	200	32	QSM 200/SM 200	8,80
724581195 T	HA5760623008	250	32	SM 250 (vario)	12,00

OPTIC



Set beschermglazen voor slijpmachines Optimum. Set bestaande uit linker en rechter beschermglas, elk met bevestigingsstuk, support naar slijpmolen niet inbegrepen.

Order nr.	891006016 M
Orig. nr.	0380099
Voor type	QSM/SM 150-250
Prijs	20,50

OPTIMUM



Afzuigadapter voor slijpmachines SM. Aansluiting binnendiameter 27mm. Aansluiting buitendiameter 31/35/40/50mm. Tot uitputting voorraad.

Order nr.	Orig. nr.	Voor type	Afmetingen (l x b x h) mm	Prijs €
713107105 M	3107105	SM175/SM200	345 x 150 x 50	52,00
713107106 M	3107106	SM250	345 x 150 x 50	52,00

OPTIMUM



Vervang diamantschijf voor GH10T en GH15T.

Order nr.	713100126 ^M	713100127 ^M
Orig. nr.	DSGH10T	DSGH15T
Voor type	GH10T	GH15T
Gewicht	1,00	1,00
Afmetingen (l x b x h)	200 x 120 x 50	200 x 120 x 50
Prijs	€ 83,00	€ 189,00

OPTIMUM

Slijpstenen voor Optimum boreslijpmachine DG20

- Rooskleurige slijpsteen (standaard slijpsteen) voor het bewerken van HSS
- Groendkleurige slijpsteen voor het bewerken van hard metaal



Order nr.	713107120 ^M	713107121 ^M
Orig. nr.	3107120	3107121
Prijs	€ 20,50	€ 20,50

OPTIMUM



Contactwiel voor bandschuurmachines BSM en BS.

Order nr.	Orig. nr.	Voor machine	Prijs €
891002489 ^M	0332107512	BSM75	209,00
891024558 ^M	0332115094	BSM150	309,00
891566239 ^M	BS75200-59	BS75200 - MBSM75-2000	159,00

metalkraft



Accessoires voor slijpmachine Metalkraft RPSM2.

- Afzonderlijke optionele slijprollen voor diverse buisdiameters.
- Geweven filterzak.

Order nr.	Orig. nr.	Omschrijving	Diameter mm	Prijs €
713723090 ^M	3723090	rollen	20	80,00
713723091 ^M	3723091	rollen	26	87,50
713723092 ^M	3723092	rollen	32	93,50
713723093 ^M	3723093	rollen	42	95,50
713723094 ^M	3723094	rollen	48	98,00
713723095 ^M	3723095	rollen	60	128,00
713723096 ^M	3723096	rollen	76	141,00
713722101 ^M	3722101	Filterzak	-	50,50

metalkraft



Afzonderlijke slijprollen voor KRBS100, 713705100.

Slijprollen duimse maten eveneens verkrijgbaar:

- 3/4" - 713705127
- 1" - 713705133
- 1-1/4" - 713705143
- 1-1/2" - 713705149
- 2" - 713705161

Order nr.	Orig. nr.	Diameter mm	Voor type	Prijs €
713705120	3705120	20	KRBS100	80,00
713705126	3705126	26	KRBS100	87,50
713705132	3705132	32	KRBS100	93,50
713705142	3705142	42	KRBS100	95,50
713705148	3705148	48	KRBS100	97,50
713705160	3705160	60	KRBS100	128,00
713705176	3705176	76	KRBS100	141,00

OPTIMUM



Velcro schuurschijf. Aluminiumoxide korrel. Voor algemeen gebruik voor metaal en hout. Voor bandschuurmachines Optimum DBS75, Metalkraft BTS50/51, Quantum TS305, Holzkraft BTS200 en andere bandschuurmachines die werken met een velcro schijf van diameter 150 of 300 mm. Met Velcro bevestigingslaag voor een snelle en gemakkelijke schijfwissel.

Order nr.	Orig. nr.	Omschrijving	Korrel K	Voor type	Diameter mm	VE	Min. bestelhoeveelheid	Prijs/VE €
713357832	3357832	Schuurschijf	40	Optimum DBS75-Metalkraft BTS50/51	150	1	5	1,30
713357834	3357834	Schuurschijf	60	Optimum DBS75-Metalkraft BTS50/51	150	1	5	1,30
713357836	3357836	Schuurschijf	80	Optimum DBS75-Metalkraft BTS50/51	150	1	5	1,30
713357838	3357838	Schuurschijf	120	Optimum DBS75-Metalkraft BTS50/51	150	1	5	1,30
713357801	3357801	Velcro klijsteunschijf	-	Quantum TS305-Holzkraft BTS200	300	1	1	18,50
713357854	3357854	Schuurschijf	40	Quantum TS305	300	1	5	2,85
713357856	3357856	Schuurschijf	60	Quantum TS305	300	1	5	2,85
713357858	3357858	Schuurschijf	80	Quantum TS305	300	1	5	2,65
713357860	3357860	Schuurschijf	100	Quantum TS305	300	1	5	2,65
713357862	3357862	Schuurschijf	120	Quantum TS305	300	1	5	2,65
713357865	3357865	Schuurschijf	150	Quantum TS305	300	1	5	2,70
715911001	5911001	Velcroschijf 150mm	-	BTS150	150	1	1	8,00

metalkraft



Vervangfilterzaak BEG250S.

Order nr.	713722150
Orig. nr.	3722150
Prijs	59,00